



# Open plan price list



# Honey Price List

Effective November 1, 2022

Designed By Mark Müller and Chris Wright

Date	Page	Modification	Description
9.14.22		Removed power block options	
11.07.22	146	Height of workstation chaged from 1" to 55"	
11.11.22		9% price increase applied to all items and accessories excluding options	
11.15.22		Hardwired Power Feed 120" HPF20 changed to 192" HPF192	
11.17.22		PET Screens added to 90°	
1.03.23	91	Updated pricing	
2.16.23	73	In-Line Panel Connector width changed to 16"	
2.20.23		Added 9% increase to DFT, DFP, DHA	
3.13.23		Removed the PET color City Brown	
3.23.23		Discontinued the PET colors: 45 Big Red, 63 Medium Gray, 21 Indigo Blue, 05 Dark Green, 9 Green Apple, 76 Heathered Teal.	
3.23.23		Added the PET colors: 36 Berry Red, 3 Light Gray, 34 Pure Gray, 9 Deep Blue, 44 Ivory, 53 Smoky Beige, 47 Emerald	
4.18.23		Fabric power panel covers are now made out of white acrylic	

Statement of Line  
 Features & Advantages .....1  
 Fabric & Leather Program .....3  
 Finishes | Specifications .....6  
 Metal Finishes | Specifications.....7  
 PET | Specifications.....8  
 Edges | Specifications .....9  
 Pulls .....10  
 Grommets .....11  
 Grain Direction .....12  
 Honey Wire Management.....13  
 Honey Workstation Dimensions.....14  
 Honey New York Power .....16  
 Honey West Coast Power .....17  
 Chicago Power.....18  
 Drawer Dimenisons.....19  
 Honey 120 degree Typicals.....20  
 Honey Lounge.....68  
 120 degree Honey Panels.....69  
 Power Entry Box.....78  
 Tops.....79  
 Fixed Tables.....81  
 Privacy Screens.....83  
 Storage Credenzas.....86  
 Wardrobe Storage.....88  
 Mobile Pedestal.....91  
 Honey 120 Mobile Workstation.....92  
 120 Degree Return Top .....94  
 90 Degree Honey.....97  
 90 Degree Typicals.....98  
 90 Degree Panels.....134  
 90 Degree Worksurfaces .....143  
 90 Degree Mobile Workstations.....145  
 90 Degree Privacy Screens .....147  
 Options .....149  
 Power I Specifications.....158

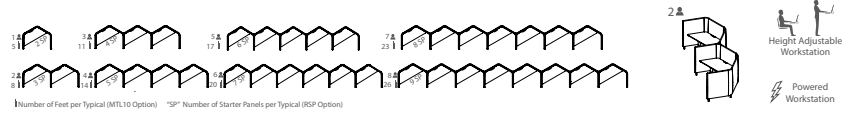

Page 20  
 Inline Diagonal Workstation Typical  
 Position 1 with Height Adjustable Worksurface

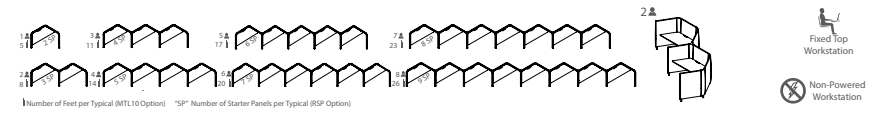

Page 21  
 Inline Diagonal Workstation Typical  
 Position 1 with Fixed Worksurface

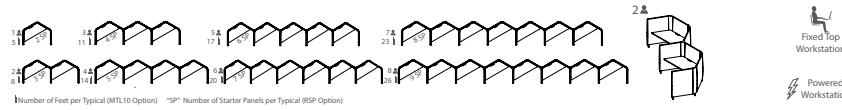

Page 22  
 Inline Diagonal Workstation Typical  
 Position 1 with Power Fixed Worksurface

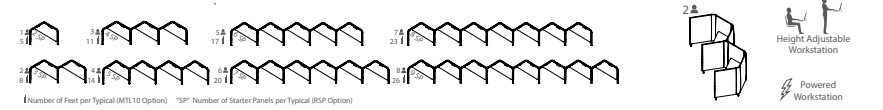

Page 23  
 Inline Diagonal Workstation Typical  
 Position 2 with Height Adjustable Worksurface

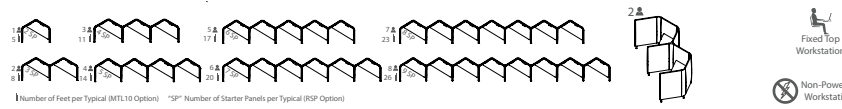

Page 24  
 Inline Diagonal Workstation Typical  
 Position 2 with Fixed Worksurface

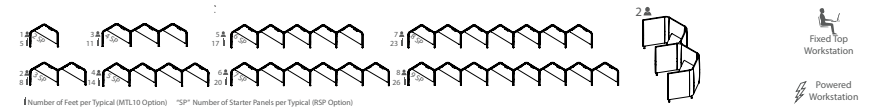

Page 25  
 Inline Diagonal Workstation Typical  
 Position 2 with Power Fixed Worksurface



Page 26  
 Facing Diagonal Workstation Typical  
 Position 1 with Height Adjustable Worksurface

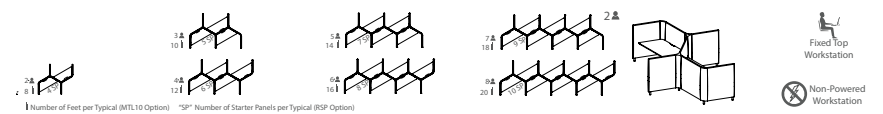

Page 27  
 Facing Diagonal Workstation Typical  
 Position 1 Desk with Fixed Worksurface

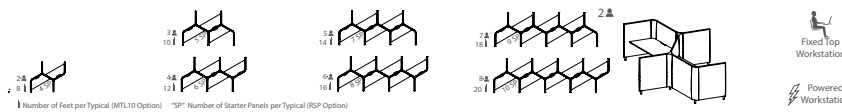

Page 28  
 Facing Diagonal Workstation Typical  
 Position 1 Desk with Power Fixed Worksurface

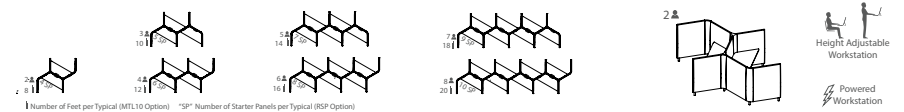

Page 29  
 Facing Diagonal Workstation Typical  
 Position 2 Desk with Height Adjustable Worksurface

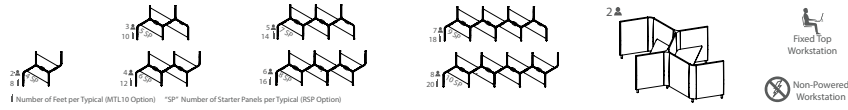

Page 30  
Facing Diagonal Workstation Typical  
Position 2 Desk with Fixed Worksurface

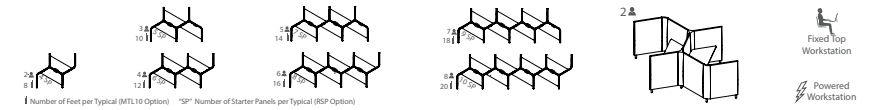

Page 31  
Facing Diagonal Workstation Typical  
Position 2 Desk with Power Fixed Worksurface

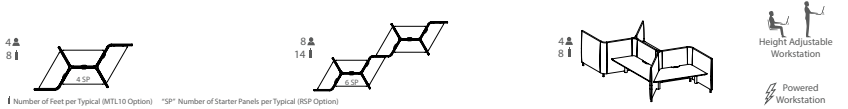

Page 32  
Diamond Workstation Typical  
Diamond Workstation with Height Adjustable Worksurface

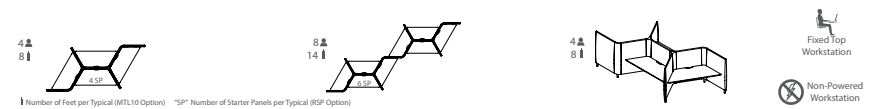

Page 33  
Diamond Workstation Typical  
Diamond Workstation with Fixed Worksurface

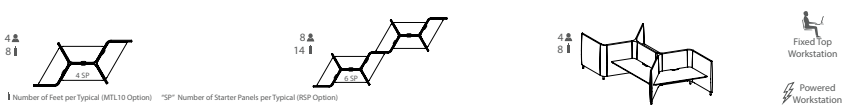

Page 34  
Diamond Workstation Typical  
Diamond Workstation with Power Fixed Worksurface

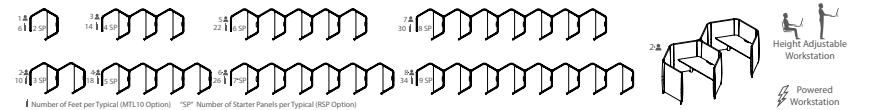

Page 35  
Inline Hexagon Workstation Typical  
Position 1 Desk with Height Adjustable Worksurface

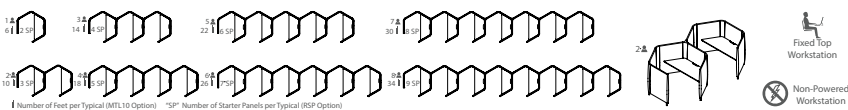

Page 36  
Inline Hexagon Workstation Typical  
Position 1 Desk with Fixed Worksurface

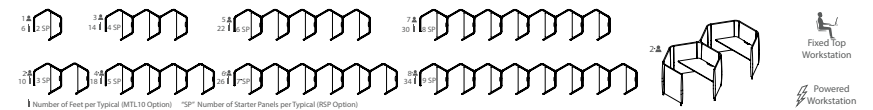

Page 37  
Inline Hexagon Workstation Typical  
Position 1 Desk with Power Fixed Worksurface

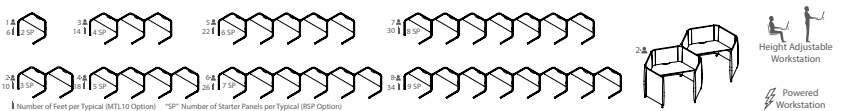

Page 38  
Inline Hexagon Workstation Typical  
Position 2 Desk with Height Adjustable Worksurface

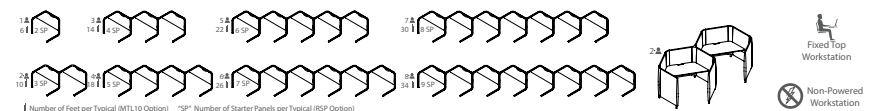

Page 39  
Inline Hexagon Workstation Typical  
Position 2 Desk with Fixed Worksurface

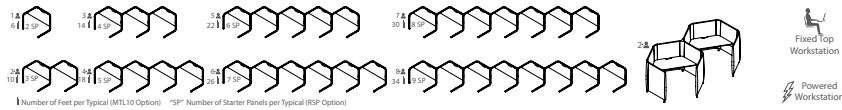

Page 40  
 Inline Hexagon Workstation Typical  
 Position 2 Desk with Power Fixed Worksurface

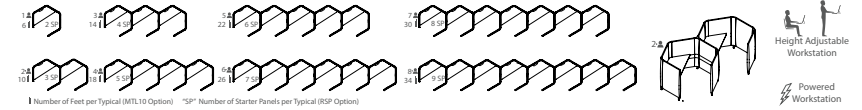

Page 41  
 Inline Hexagon Workstation Typical  
 Position 3 with Height Adjustable Worksurface

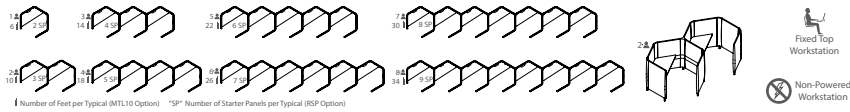

Page 42  
 Inline Hexagon Workstation Typical  
 Position 3 Desk with Fixed Worksurface

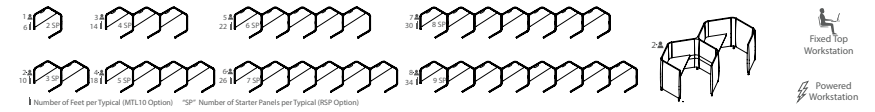

Page 43  
 Inline Hexagon Workstation Typical  
 Position 3 Desk with Power Fixed Worksurface

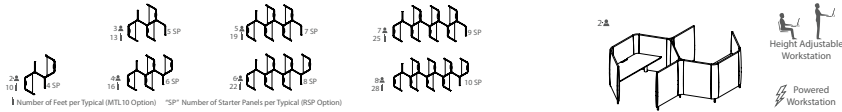

Page 44  
 Double Hexagon Workstation Typical  
 Position 1 Desk with Height Adjustable Worksurface

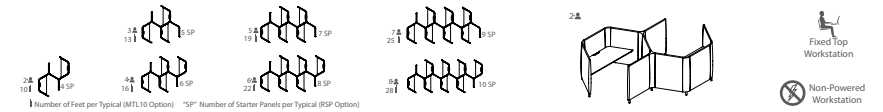

Page 45  
 Double Hexagon Workstation Typical  
 Position 1 Desk with Fixed Worksurface

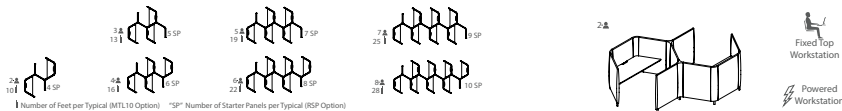

Page 46  
 Double Hexagon Workstation Typical  
 Position 1 Desk with Power Fixed Worksurface

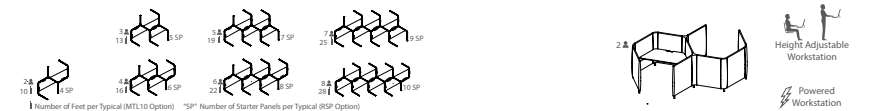

Page 47  
 Double Hexagon Workstation Typical  
 Position 2 Desk with Height Adjustable Worksurface

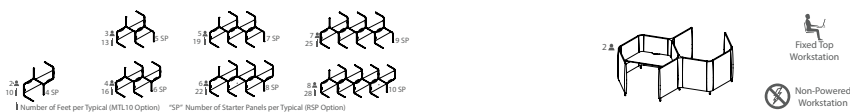

Page 48  
 Double Hexagon Workstation Typical  
 Position 2 Desk with Fixed Worksurface

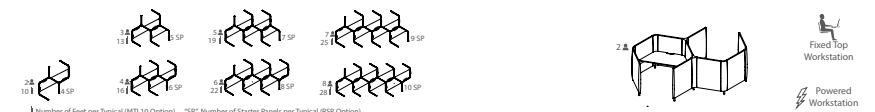

Page 49  
 Double Hexagon Workstation Typical  
 Position 2 Desk with Power Fixed Worksurface

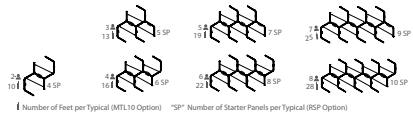

Page 50  
Double Hexagon Workstation Typical  
Position 3 Desk with Height Adjustable Worksurface

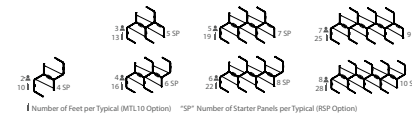
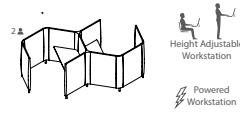

Page 51  
Double Hexagon Workstation Typical  
Position 3 Desk with Fixed Worksurface

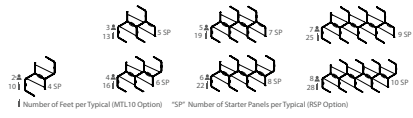
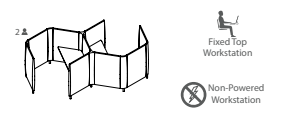

Page 52  
Double Hexagon Workstation Typical  
Position 3 Desk with Power Fixed Worksurface

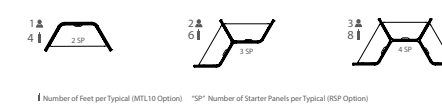
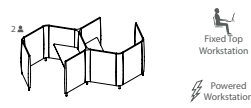

Page 53  
Hexagon Workstation Typical  
Desk with Height Adjustable Worksurface



Page 54  
Hexagon Workstation Typical  
Desk with Fixed Worksurface

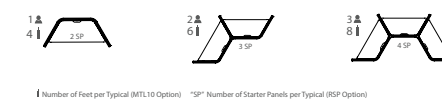

Page 55  
Hexagon Workstation Typical  
Desk with Power Fixed Worksurface



Page 56  
Hexagon Workstation Typical  
Five Person Workstation with Height Adjustable Worksurface



Page 57  
Hexagon Workstation Typical  
Five Person Workstation with Fixed Worksurface



Page 58  
Hexagon Workstation Typical  
Five Person Workstation with Power Fixed Worksurface

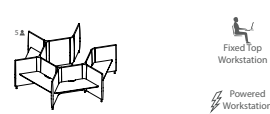

Page 59  
Hexagon Workstation Typical  
Six Person Workstation with Height Adjustable Worksurface

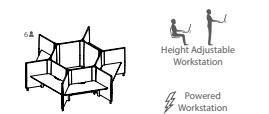



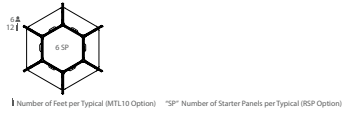

Page 60  
Hexagon Workstation Typical  
Six Person Workstation with Fixed Worksurface

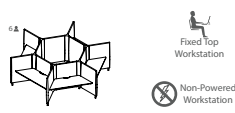

Page 61  
Hexagon Workstation Typical  
Six Person Workstation with Power Fixed Worksurface



Page 62  
Linear Workstation Typical  
Desk with Height Adjustable Worksurface



Page 63  
Linear Workstation Typical  
Desk with Fixed Worksurface



Page 64  
Linear Workstation Typical  
Desk with Power Fixed Worksurface

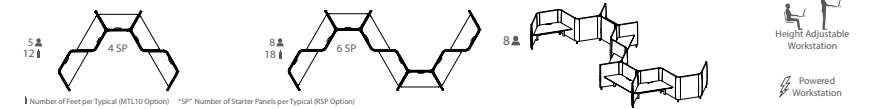

Page 65  
S-Shaped Workstation Typical  
Desk with Height Adjustable Worksurface

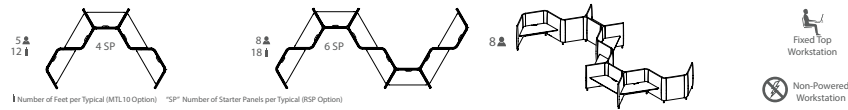

Page 66  
S-Shaped Workstation Typical  
Desk with Fixed Worksurface

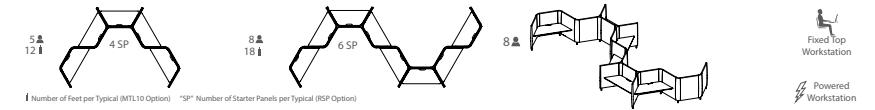

Page 67  
S-Shaped Workstation Typical  
Desk with Power Fixed Worksurface

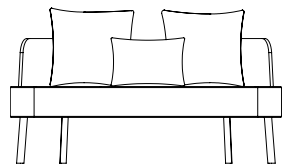

Page 68  
120° Lounge  
Lounge with Seat and Back Cushions



Page 69  
120° Starter Panel  
Round End

Statement of Line

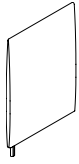

Page 70  
120° Starter Panel  
Flat End

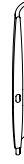

Page 71  
120° Corner Panel Connector  
Two Corner Panel

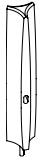

Page 72  
120° Corner Panel Connector  
Three Corner Panel



Page 73  
In-Line Panel Connector  
Straight Run Connector



Page 74  
120° Adder Panel  
No Power Access

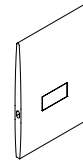

Page 75  
120° Adder Access Panel  
Single Sided Access

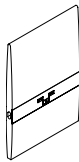

Page 76  
120° Single Sided Power Panel  
Power Panel

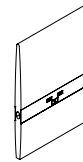

Page 77  
120° Double Sided Power Panel  
Power Panel

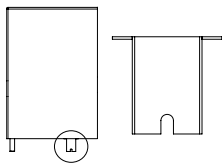

Shown on  
HNY3555SP889  
Panel not included

Page 78  
Concealed Floor Power Infeed Cover  
Power Cable Entry Box

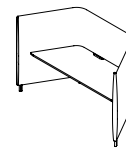

Panels  
not included  
Page 79  
120° Worksurface Top  
Worksurface with Fixed Top



Fixed Top  
Worksurface



Panels  
not included  
Page 80  
120° Worksurface Top  
Worksurface with Height Adjustable Top

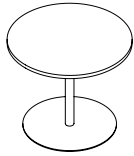

Page 82  
Fixed Circular Table  
Fixed Circular Table - Sitting Height



Top  
not included

Page 84  
120° Worksurface Privacy Screen  
Worksurface Veneer Privacy Screen

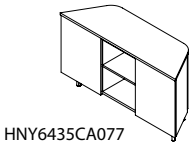

HNY6435CA077

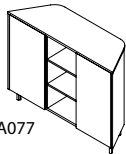

HNY6448CA077

Page 86  
64" Wide Push-In Storage Credenza  
Storage Credenza with Sliding Doors

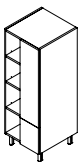

Page 88  
Single Sided Open Storage Tower  
Open Storage Tower with Left File / Wardrobe Access



Page 81  
Fixed Triangular Table  
Fixed Triangular Table - Sitting Height

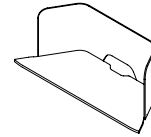

Top  
not included

Page 83  
120° Worksurface Privacy Screen  
Worksurface PET Privacy Screen

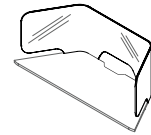

Top  
not included

Page 85  
120° Worksurface Privacy Screen  
Worksurface Acrylic Privacy Screen

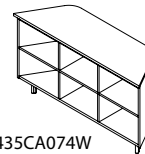

HNY6435CA074W



HNY6448CA074W

Page 87  
120° Open Storage Credenza  
Open Storage Credenza

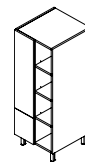

Page 89  
Single Sided Open Storage Tower  
Open Storage Tower with Right File / Wardrobe Access

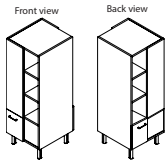

Page 90  
Two Person Double Sided - Freestanding Shared Storage  
All-in-One Cabinet-Double Sided



Page 92  
Mobile Workstation Typical  
Desk with Height Adjustable Worksurface

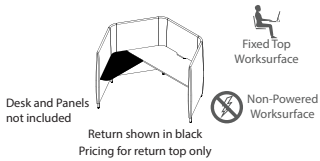

Page 94  
120° Return Worksurface Top  
Left Fixed Worksurface

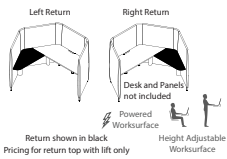

Page 96  
120° Return Worksurface Top  
Height Adjustable Top

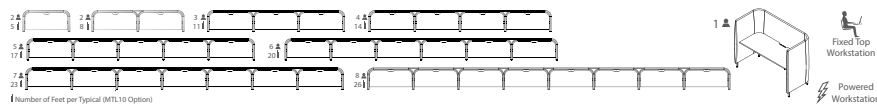

Page 98  
Inline 90° Workstation Typical  
Position 1 Desk with Power Fixed Worksurface

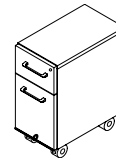

Page 91  
Open Plan Mobile Pedestal  
Mobile B/F Desk Pedestal With Casters



Page 93  
Mobile Workstation Typical  
Desk with Fixed Worksurface



Page 95  
120° Return Worksurface Top  
Right Fixed Worksurface

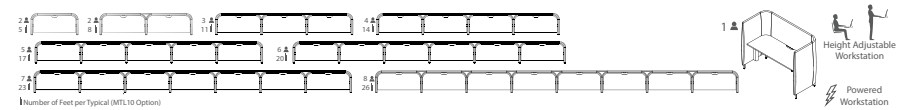

Page 97  
Inline 90° Workstation Typical  
Position 1 Desk with Height Adjustable Worksurface

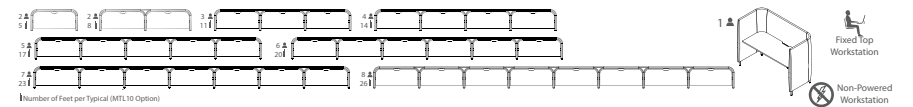

Page 99  
Inline 90° Workstation Typical  
Position 1 Desk with Fixed Worksurface

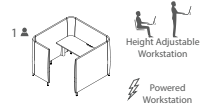
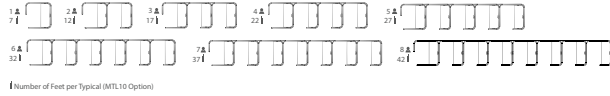

Page 100  
 Inline 90° Workstation Typical  
 Position 2 Desk with Height Adjustable Worksurface

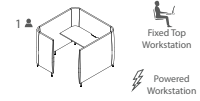
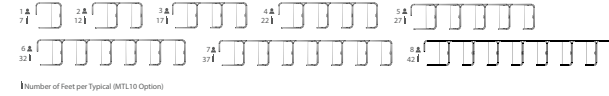

Page 101  
 Inline 90° Workstation Typical  
 Position 2 Desk with Power Fixed Worksurface

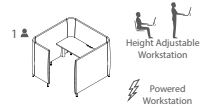
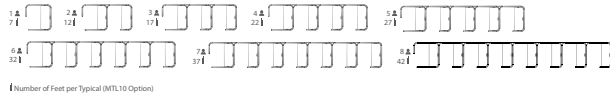

Page 102  
 Inline 90° Workstation Typical  
 Position 2 Desk with Fixed Worksurface

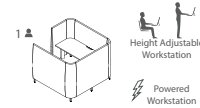
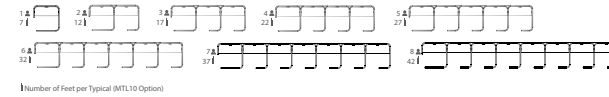

Page 103  
 Inline 90° Workstation Typical  
 Position 3 Desk with Height Adjustable Worksurface

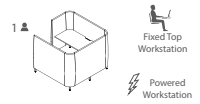
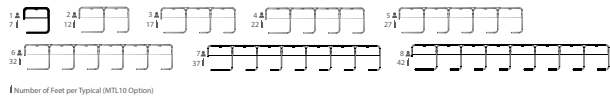

Page 104  
 Inline 90° Workstation Typical  
 Position 3 Desk with Power Fixed Worksurface

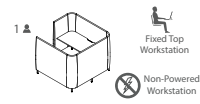

Page 105  
 Inline 90° Workstation Typical  
 Position 3 Desk with Fixed Worksurface

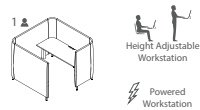
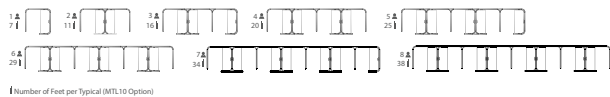

Page 106  
 Inline 90° Workstation Typical  
 Position 4 Desk with Height Adjustable Worksurface

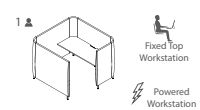
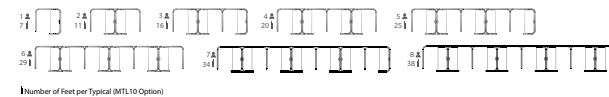

Page 107  
 Inline 90° Workstation Typical  
 Position 4 Desk with Power Fixed Worksurface

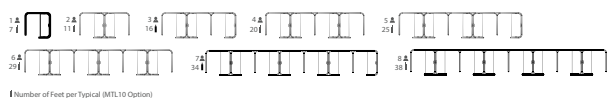

Page 108  
 Inline 90° Workstation Typical  
 Position 4 Desk with Fixed Worksurface

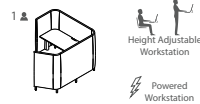
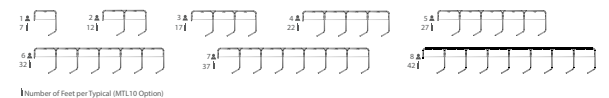

Page 109  
 Inline 90° Workstation Typical  
 Position 5 Desk with Height Adjustable Worksurface

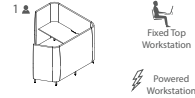
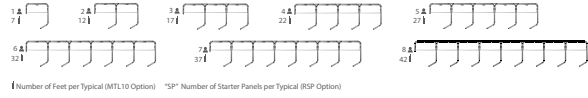

Page 110  
Inline 90° Workstation Typical  
Position 5 Desk with Power Fixed Worksurface

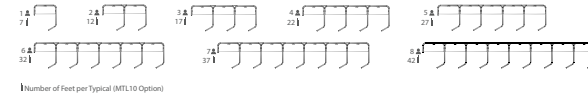

Page 111  
Inline 90° Workstation Typical  
Position 5 Desk with Fixed Worksurface

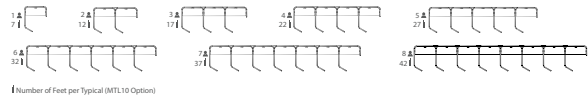

Page 112  
Inline 90° Workstation Typical  
Position 6 Desk with Height Adjustable Worksurface

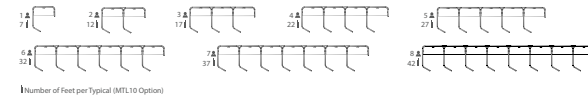

Page 113  
Inline 90° Workstation Typical  
Position 6 Desk with Power Fixed Worksurface

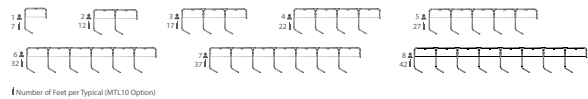

Page 114  
Inline 90° Workstation Typical  
Position 6 Desk with Fixed Worksurface



Page 115  
Linear 90° Workstation Typical  
Height Adjustable Worksurface

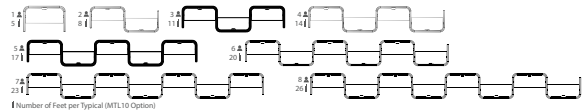

Page 116  
Linear 90° Workstation Typical  
Fixed Power Worksurface

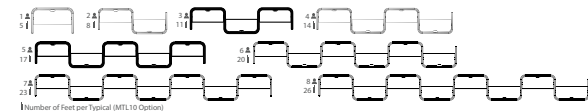

Page 117  
Linear 90° Workstation Typical  
Fixed Worksurface

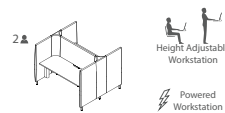

Page 118  
Facing 90° Workstation Typical  
Position 1 Desk with Height Adjustable Worksurface

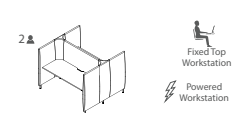
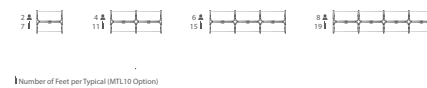

Page 119  
Facing 90° Workstation Typical  
Position 1 Desk with Fixed Power Worksurface



Number of Feet per Typical (MTL10 Option)

Page 120  
Facing 90° Workstation Typical  
Position 1 Desk with Fixed Worksurface

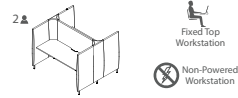

Fixed Top Workstation  
Non-Powered Workstation



Number of Feet per Typical (MTL10 Option)

Page 121  
Facing 90° Workstation Typical  
Position 2 Desk with Height Adjustable Worksurface

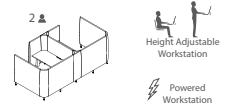

Height Adjustable Workstation  
Powered Workstation



Number of Feet per Typical (MTL10 Option)

Page 122  
Facing 90° Workstation Typical  
Position 2 Desk with Fixed Power Worksurface

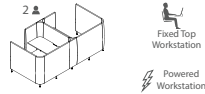

Fixed Top Workstation  
Powered Workstation



Number of Feet per Typical (MTL10 Option)

Page 123  
Facing 90° Workstation Typical  
Position 2 Desk with Fixed Worksurface

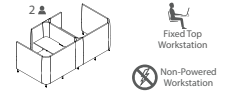

Fixed Top Workstation  
Non-Powered Workstation



Number of Feet per Typical (MTL10 Option)

Page 124  
Facing 90° Workstation Typical  
Position 3 Desk with Height Adjustable Worksurface

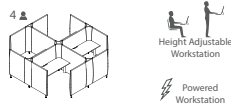

Height Adjustable Workstation  
Powered Workstation

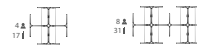

Number of Feet per Typical (MTL10 Option)

Page 125  
Facing 90° Workstation Typical  
Position 3 Desk with Fixed Power Worksurface

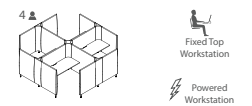

Fixed Top Workstation  
Powered Workstation



Number of Feet per Typical (MTL10 Option)

Page 126  
Facing 90° Workstation Typical  
Position 3 Desk with Fixed Worksurface

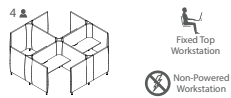

Fixed Top Workstation  
Non-Powered Workstation

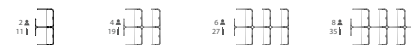

Number of Feet per Typical (MTL10 Option)

Page 127  
Double 90° Workstation Typical  
Position 1 Height Adjustable Desk



Height Adjustable Workstation  
Powered Workstation



Number of Feet per Typical (MTL10 Option)

Page 128  
Double 90° Workstation Typical  
Position 1 Fixed Power Worksurface

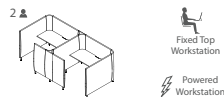

Fixed Top Workstation  
Powered Workstation



Number of Feet per Typical (MTL10 Option)

Page 129  
Double 90° Workstation Typical  
Position 1 Fixed Worksurface

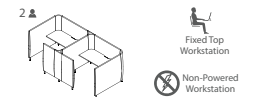

Fixed Top Workstation  
Non-Powered Workstation

Statement of Line



Number of Feet per Typical (MTL10 Option)

Page 130  
Double 90° Workstation Typical  
Position 2 Height Adjustable Desk

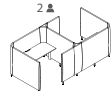

Height Adjustable Workstation



Powered Workstation



Number of Feet per Typical (MTL10 Option)

Page 131  
Double 90° Workstation Typical  
Position 2 Fixed Power Worksurface

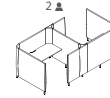

Fixed Top Workstation



Powered Workstation

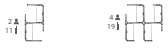

Number of Feet per Typical (MTL10 Option)

Page 132  
Double 90° Workstation Typical  
Position 2 Fixed Worksurface

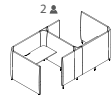

Fixed Top Workstation



Non-Powered Workstation



Page 133  
90° Starter Panel  
Flat End

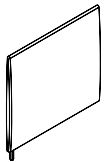

Page 134  
90° Starter Panel  
Flat End



Page 135  
90° Corner Panel Connector  
Two Way Corner Connector



Page 136  
90° Corner Panel Connector  
Three Way Corner Connector



Page 137  
90° Corner Panel Connector  
Four Way Corner Connector

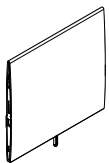

Page 138  
90° Adder Panel  
No Power Access

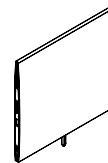

Page 139  
90° Adder Panel  
Single Sided Access



Statement of Line

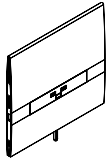

Page 140  
90° Single Sided Power Panel  
Power Panel

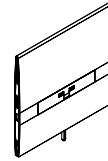

Page 141  
90° Double Sided Power Panel  
Power Panel

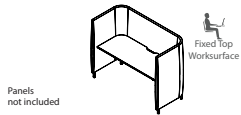

Page 142  
90° Worksurface Top  
Worksurface with Fixed Top

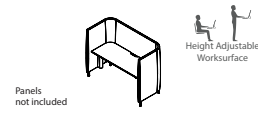

Page 143  
90° Worksurface Top  
Worksurface with Height Adjustable Top



Page 144  
Mobile 90° Workstation Typical  
Desk with Fixed Worksurface



Page 145  
Mobile 90° Workstation Typical  
Desk with Height Adjustable Worksurface

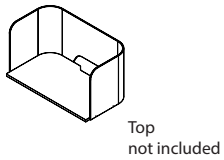

Page 146  
90° Worksurface Privacy Screen  
Worksurface PET Privacy Screen

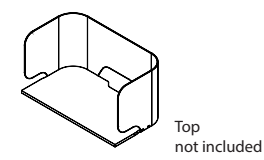

Page 147  
90° Worksurface Privacy Screen  
Worksurface Acrylic Privacy Screen

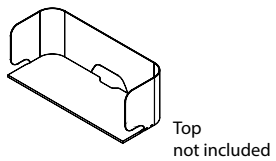

Page 148  
90° Worksurface Privacy Screen  
Worksurface Acrylic Privacy Screen

# DARRAN®

## Veneer tops

Veneer tops are 1" thick and comprised of 45-pound density MDF core with a balanced 3-ply construction. Veneer tops, screens, and lounge backs are standard in Quartered Walnut and Rift Cut White Oak Veneers that are slip-matched. Veneer tops are available in Flat or Cliff edge profile, with multiple banding options. Tops are finished in either 5-sheen matte finish or 40-sheen depending on finish selection.

## HPL laminate tops

Honey high-pressure laminate tops are 1" thick and comprised of 45-pound density MDF core with a balanced 3-ply construction. Tops are available in Flat or Cliff edge profile, with multiple banding option.

## TFL tops

Thermally Fused Laminate tops are 1-1/8" thick and fused to a 45-pound density substrate of the top for a durable surface. Tops are available in a Flat edge profile with multiple banding options.

## Panel construction

Panels are composed of 3/4" and 1" birch plywood with tenon and groove construction that is secured with screws and glued. MDF trim pieces create soft rounded edges and beautiful contours. The frame is covered with 4.5mm PET acoustic panels for sound absorption. PET panels are composed of recycled content, are flame retardant, mold resistant and have zero emissions. Panels are standard elevated on 5" solid wood legs that feature 2" Glide for adjustment on uneven surfaces.

## Case construction

Case pieces including pedestals, towers and credenzas are constructed of 3/4" thick particle board with 3-ply balanced construction. Pedestal and Cabinets feature dowel construction reinforced with steel bracket plates, wood cleats, screws and glue. Credenzas and Towers are elevated on 6" solid wood legs featuring 1" glide for adjustment on uneven surfaces.

## Lounge construction

Lounge units are constructed from plywood with 2" thick bottom platform, 3/4" seat pan and 4" of high resiliency foam for comfort and durability. The honey Lounge back is a curved plywood core with veneer or laminate. Honey lounge consists of high resilient foam with a minimum of 2.5 density in seats and blown fiber cushions, further advances support and durability.

Lounge unit is elevated on 10.5" solid wood leg with oval shape to match panel stations.

## Screens

Honey screens are available in Acrylic or Veneer over plywood. Acrylic is 1/4" thick and available in frosted, white, and black. Plywood screens are 1/2" thick and are available in Quartered Walnut and Rift Cut White Oak Veneer that runs horizontally on the screen. Screens secure to the

## Honey Features & Advantages

underside of the worksurfaces with an L bracket. Screens feature a center cutout to allow clip-on power pods and easy wire management to the MGT: Wire Tray below the worksurface. The screen is 24" tall for added privacy; the screen's unique curved wings mimic the worksurface top creating a barrier between users and work area to focus.

## Cleaning wood & laminate

In addition to regular dusting, give your furniture an occasional cleaning in accordance with our cleaning instructions. DARRAN wood and laminate products can be cleaned with a soft cloth and a mild soap and water mixture. Use approximately 32 oz of water mixed with one tablespoon of dish soap, always wiping with the grain. Dry with a soft cloth, going with the grain, to avoid spotting or streaking.

Wood products should be waxed periodically using a non-wax liquid; please do not use any waxy polish or cleaner. Interior of drawers may also be cleaned with mild soap and water mixture, or any household cleaner that is not petroleum or thinner-based.

## Suspensions

All cabinets and mobile pedestals utilize cold rolled steel zinc plated high-grade drawer suspensions. All suspensions are warranted for the lifetime of the product. Box and File drawers are full extension, featuring steel ball bearings for a smoother quieter range of motion with soft close operation and are rated 100lbs.

## Filing

Honey features a highly durable black plastic extrusion that is securely fastened into a route on top of the drawer to support hanging files. An adjustable crossbar is provided for all file drawers that enables legal/letter filing front to back or side-to-side based on the drawer size.

## Locks

Locks are optional on pedestals and doors. Each drawer pedestal is independently locked. Lock plugs are factory or field installed.

## Keying

Keying is available either factory or field installed. Factory installed keying offers two options: random or designated. When the random keying option is selected an arbitrary key number will be assigned to the unit. When the designated keying option is selected a key number must be specified between 101 and 110. Higher numbers may be specified if noted on the purchase order and may be factory or field installed. Black and silver face lock have silver keys.

## Wire management

Wire management capabilities include standard and optional worksurface grommets. Specify W21 under surface wire channels for organization and management of all communication wires and cords. Sold separately to conceal wire under worksurfaces. Top feature a cutout in the back and unique curved wings allowing for clip on modules or easy wire management to the power tray below the worksurface.

## Grommets

Metal grommets are provided to match the drawer pull selection. Metal grommets are available in black, silver or white. Must specify standard or non-standard location. TM50 Black plastic grommets are available as an option for vertical applications.

### Seating & fabric leather program

DARRAN has partnered with some of the most prestigious fabric suppliers of the office furniture industry to bring you quality fabrics that are engaging designs, environmentally friendly and durable for years to come. The majority of fabrics we have graded-in are in heavy supply making it most likely available on our Quickship however, we cannot guarantee stock. If you do not see the fabric you wish to include in a project, please contact our Factory to see if this pattern can be graded in at 800.334.7891.

### Panel fabric program

ALL COM fabric must be preapproved by DARRAN. Leather fabric program is not approved on panels. Due to stretching and sagging textile content for panels shouldnt exceed a combined 50% cotton, linen, nylon and/or rayon is not recommended. Panel fabrics are required to have flame certificates that meet ASTM E84 Adhered (for power panels) and Unadhered (for panels). DARRAN does not accept responsibility of collecting flame certificates for COM.

### Fabrics & leathers

Please visit our Seating Fabrics page at [darran.com/textilesleather](http://darran.com/textilesleather)

Camira  
[www.camirafabrics.com](http://www.camirafabrics.com)  
800.334.789

Wollsdorf  
[www.wollsdorf.com](http://www.wollsdorf.com)  
336.884.5005

CFStinson  
[www.cfstinson.com](http://www.cfstinson.com)  
800.841.6279

Green Hides  
[www.greenhides.com](http://www.greenhides.com)  
336.315.9720

DesignTex  
[www.designtex.com](http://www.designtex.com)  
800.797.4949

Maharam  
[www.maharam.com](http://www.maharam.com)  
800.645.3943

Momentum Textiles  
[www.momentumtextiles.com](http://www.momentumtextiles.com)  
800.366.6839

Ultrafabrics  
[www.ultrafabricsinc.com](http://www.ultrafabricsinc.com)  
800.334.7891

Application instructions must be specified on the purchase order or COM / COL submission form. In the absence of application instructions, DARRAN will apply materials accordingly.

### CAL117

All DARRAN seating products conform to California Technical Bulletin 117 as a minimum standard.

### CAL133

To meet the California Technical Bulletin 133 flammability regulation, a combination of proper materials must be used to pass, as it tests the fire resistance of a finished product. Flame resistant fabric, a fire blocker material and special foam must be used to pass CAL133 fire codes.

Testing is available for all seating products with the following fees and considerations:

- If laboratory certification is not required, any style can be manufactured to comply with California Technical Bulletin 133 for \$75 list per yard required. (Customer's Own Materials must factor in additional yardage requirements based on repeat.)
- The purchase order must clearly indicate the requirement of California Technical Bulletin 133
- If laboratory California Technical Bulletin 133 certification is required, the cost of testing a chair is \$820 NET, plus the cost of the chair and covering material.
- An additional lead time of 4 to 6 weeks is required for testing for CAL133.
- Once testing is completed, we will provide a certification letter specific to the sample tested for CAL133.
- DARRAN's manufacturing procedures for California TB 133 compliance are based on the testing of representative style with specific fabrics. Please contact Customer Service for an updated list of tested models.
- A copy of test certification is available upon request.

**Combination fabrics**

DARRAN is pleased to offer customers the design freedom of combination fabrics. When using fabric, vinyl or leather combinations, pricing will be as follows:

- When combining two materials of the same grade, pricing will be specified grade + 5%.
- If combining two materials of different grades or leather/ fabric combination, use the highest grade/price + 5%.
- If using COM or COL, pricing will be COM or COL + 5%. If both COM + COL are used in combination, use COL + 5%

**COM/COL ordering instructions**

Please complete the COM Submission Form prior to ordering the fabric from the supplier. All COM fabrics must be approved prior to order submission. Please refer to our website or contact DARRAN Seating Customer Service for an updated list of preapproved COM fabrics. Application instructions must be specified on the purchase order or COM/COL submission form. In the absence of application instructions, DARRAN will apply materials in the best manner and cannot be held responsible for tailoring or application objections after upholstering. COM orders will be scheduled for production after receipt of the material. Packages must be clearly marked and the fabric must be first quality, continuous yardage.

**COM/COL yardage requirements**

The yardage requirements stated in this price list for each style are calculated using 54" wide, non-directional fabrics. For fabrics with a different width or for patterns with repeats, please refer to the below chart to calculate the additional percent of fabric required:

Fabric Width	Plain Fabric	2" - 14" Repeat	15" - 19" Repeat	20" - 27" Repeat	28" - 36" Repeat
54"	0	15%	20%	25%	30%
53"	6%	19%	24%	28%	36%
52"	13%	23%	28%	33%	38%
51"	19%	26%	31%	36%	41%
50"	25%	30%	35%	40%	45%
49"	30%	35%	40%	45%	50%
48"	35%	40%	45%	50%	55%
47"	45%	50%	55%	58%	65%

# DARRAN®

NOTE: Prior To Completion Of This Form, Please Refer To Our Graded In Materials Program For Preapproved Fabrics/Leathers.

## COM/COL Approval

DARRAN Furniture Industries  
2402 Shore Street, High Point, NC 27263  
ATTN: Seating Division / COM/COL Approval  
TAG: DARRAN Purchase Order Number

## Shipping approved COM/COL materials

DARRAN Furniture Industries  
2402 Shore Street, High Point, NC 27263  
ATTN: Seating Division / COM/COL Approval  
TAG: DARRAN Purchase Order Number

Please complete this form, attach a 6"x 6" sample and mail to the COM/COL APPROVAL address shown above.  
This form can also be downloaded from our website at [www.darran.com/leathers](http://www.darran.com/leathers) OR [www.darran.com/fabrics](http://www.darran.com/fabrics)

Purchase Order # \_\_\_\_\_

Dealer's Name \_\_\_\_\_

Contact \_\_\_\_\_

Address \_\_\_\_\_

Telephone \_\_\_\_\_

Email \_\_\_\_\_

Chair Style \_\_\_\_\_

Manufacturer \_\_\_\_\_

Pattern Name \_\_\_\_\_

Pattern Color \_\_\_\_\_

Content \_\_\_\_\_

Repeat \_\_\_\_\_

Please specify any special requirements and check the application above.

\_\_\_\_\_

\_\_\_\_\_

\_\_\_\_\_

# Honey Fabric & Leather Program

ATTACH 6" X 6" FABRIC/LEATHER SAMPLE HERE

NOTE  
Actual Fabric/Leather samples needed instead of digital images. If digital images are sent in lieu of samples, DARRAN will only verify the pattern and will not take responsibility for color variances that cannot be verified due to printing restrictions

In the absence of application instructions, DARRAN will apply the material in the best manner and cannot be held responsible for tailoring or application objections after upholstering.

Unless otherwise instructed on the purchase order, excess COM materials will be recycled at the discretion of DARRAN after six months of the original product ship date.

The COM approval solely pertains to the application of the fabric onto the specified DARRAN seating product. DARRAN's approval or acceptance does not constitute any responsibility or warranty to the overall appearance, durability, flammability, defects, dye lot variations or colorfastness of the COM. It is the customer's responsibility to ensure the COM meets CAL 117 compliance and are first quality continuous goods.

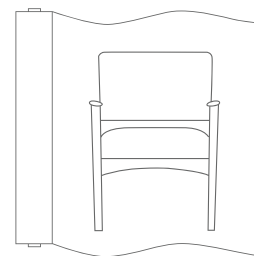

RAILROAD

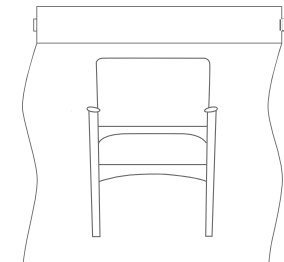

SETUP

MATTE 5% SHEEN VENEER

Specify LST-40 to change matte 5% sheen to gloss 40% sheen - N/C.

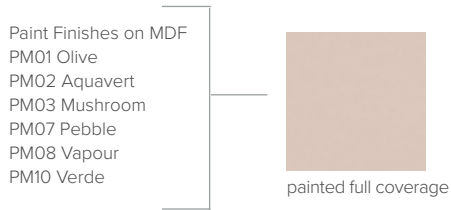

- WEC Ebony
- WOW Clear Walnut
- WNO Natural Oak
- WSO Salted Oak
- WNF Natural Oak on Flat Cut
- WMF Mocha Oak on Flat Cut
- WSF Salted Oak on Flat Cut
- WBW Henna Walnut
- WSW Smokey Walnut
- WWP Designer White

HIGH PRESSURE LAMINATE

- GEC Ebony
- GWL Designer White
- LP01 Surfin USA
- LF02 Just Rose
- LF03 Folkstone
- LN01 Cafe Sienna
- LA02 Verde Chair (20% upcharge)
- LW01 Neo Walnut
- LW02 Fawn Cypress
- LW04 Phantom Pearl
- LW05 Phantom Ecrú
- LW06 Phantom Cocoa

THERMALLY FUSED LAMINATE

- MEC Ebony
- MOC Koko Cherry
- MSW Skyline Walnut
- MTW Studio Teak
- MWL Designer White
- MNA Narvik Ash



Welltech Finish delivers a superior furniture coating with exceptional performance that can withstand stringent cleaning agents and possesses unparalleled durability, allowing DARRAN to provide lasting, sustainable products to our customers.

Height adjustable columns are standard in MFW White. MFB Black is optional when specified.

### Height Adjustable Mechanism Metal Finishes

STANDARD

OPTIONAL

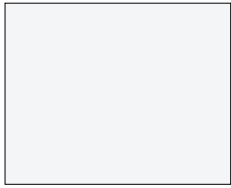

MFW White  
Satin Finish  
(Standard)



MFB Black  
Satin Finish  
(Optional - N/C)

### Feet, Table Base, Wire Tray and Bracket Metal Finishes

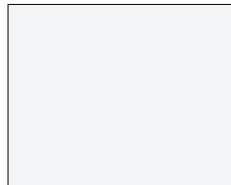

MFW White  
Satin Finish  
(Standard)

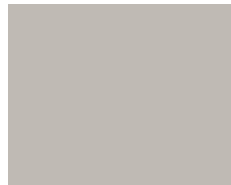

MFG Gray  
Satin Finish  
(Premium)



MFGG Graphite Gray  
Matte Finish  
(Premium)



MFS Silver  
Satin Finish  
(Premium)



MFMB Matte Black  
Matte Finish  
(Premium)



MFNA Navy  
Matte Finish  
(Premium)

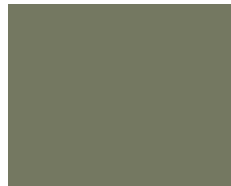

MFOL Olive  
Matte Finish  
(Premium)



MFGB Grey Beige  
Matte Finish  
(Premium)

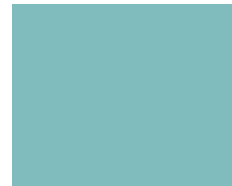

MFSA Surfin Aquavert  
Matte Finish  
(Premium)



MFOS Oyster  
Matte Finish  
(Premium)

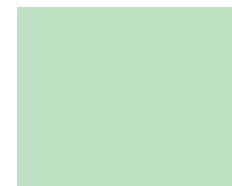

MFPS Pistachio  
Matte Finish  
(Premium)

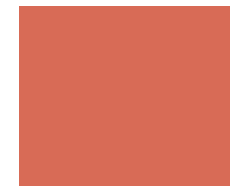

MFSS Salmon Sienna  
Matte Finish  
(Premium)



PET felt screens are available in the colors below.



Light Gray  
3



Deep Blue  
09



Dark Gray  
17



Pure Gray  
34



Berry Red  
36



Ivory  
44



Emerald  
47



Smokey Beige  
53



Heathered Granite  
71



Heathered Oatmeal  
75

Standard profile

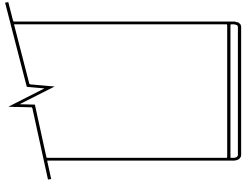

**Flat-1**

"W" "G"  
 "W" 3mm Hardwood Band  
 "G" Matching PVC Band

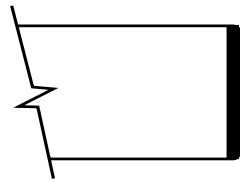

**Flat-2**

"W" "G" "M"  
 2mm Black  
 PVC Band

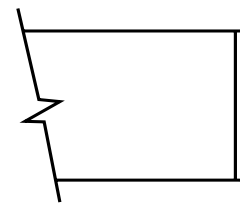

**Flat-3**

"W" "G" "M"  
 2mm White  
 PVC Band

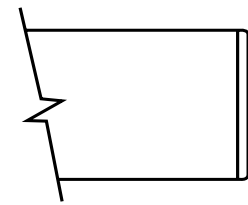

**Flat-4**

"M"  
 2mm Matching PVC Band

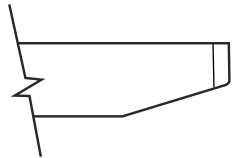

**Cliff-1**

"W" "G"  
 "W" 3mm Hardwood Band  
 "G" Matching PVC Band  
 Cutback is finished to match top



**Cliff-2**

"W" "G"  
 2mm Black PVC Band  
 Cutback is finished to match top

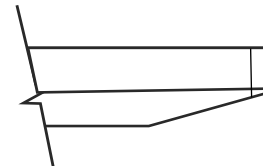

**Cliff-3**

"W" "G"  
 2mm White PVC Band  
 Cutback is finished to match top

Honey pulls come standard in PL-506 gloss white. Optional pulls available when specified.



PL - 506 Gloss White (Standard)  
PL - 507 Matte Chrome



PL - 406 Gloss White  
PL - 407 Matte Chrome



PL-115 Matte Black  
PL-116 Matte Nickel

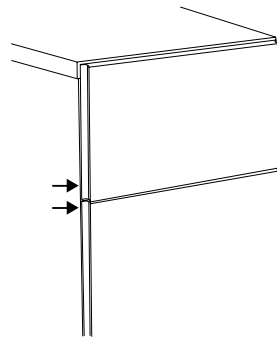

finger pull side view  
(Not available on TFL products)

TM60  
Black  
1-5/8" Dia.



### Grommets (vertical surface)

Standard Location - \$50 ea.  
- Black Plastic Vertical Surface: TM60-C (Bottom Center)

Non-Standard Location - \$95 ea.  
- Black Plastic Vertical Surface: TM60-NS

## Grain direction

All top parts, storage credenzas, pedestals and towers come with horizontal grain.

## Worksurfaces

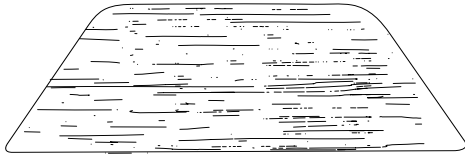

Desk/Credenza

Honey panels feature an integrated power system that daisy chains through panels to power workstations. The system features 8 wires, 4 circuits, (1 dedicated circuit), 20 amps each. Hardwired systems feature (13) duplex receptacles per circuit, (52) 15 amp duplex receptacles per power infeed maximum. The Honey power system is UL Listed as a manufactured wiring system.

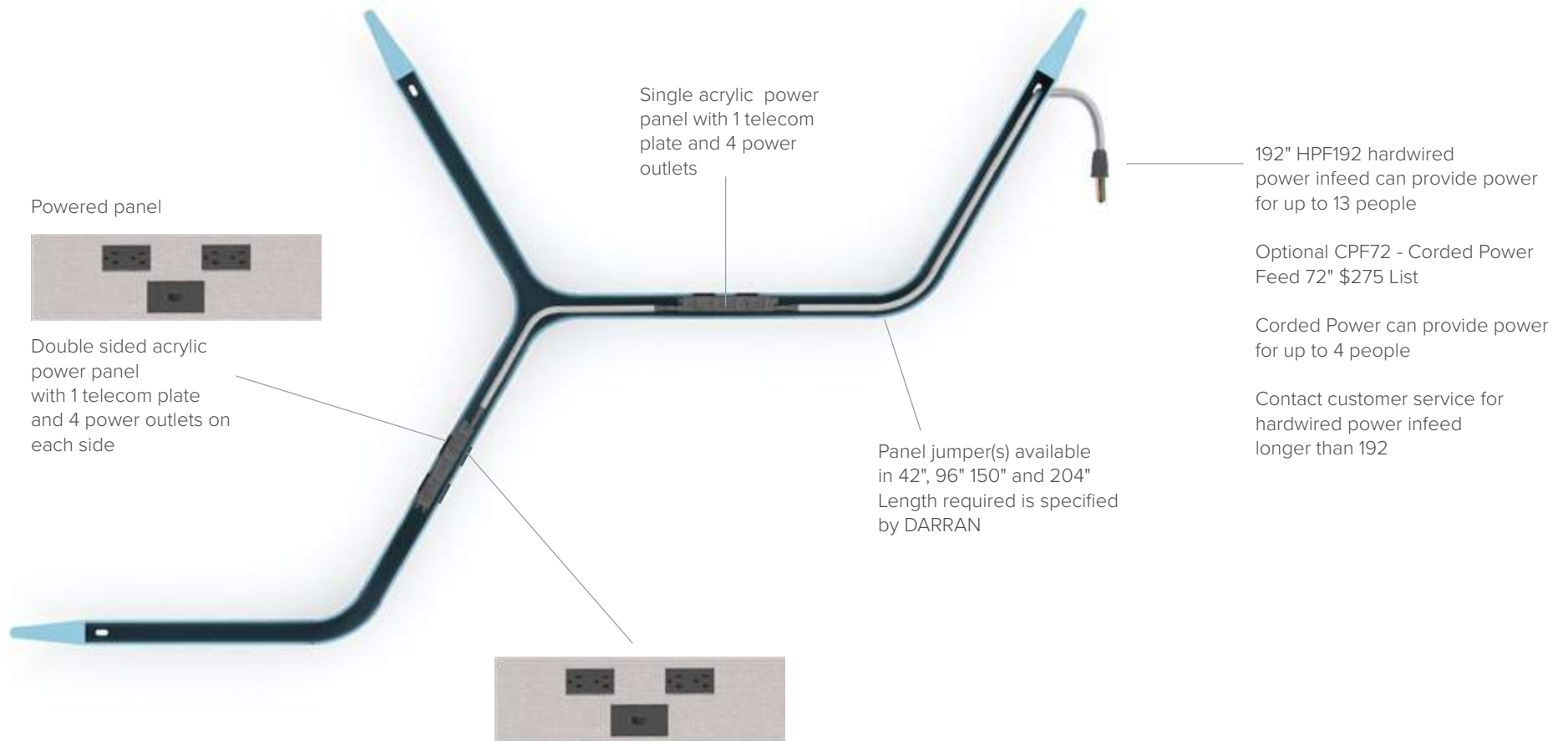

## Honey cutout

Honey worksurfaces feature a standard T75 wire management cutout to drop wires below the worksurface.

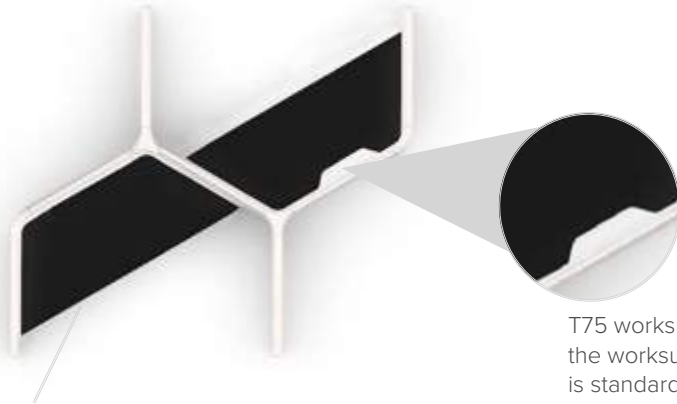

T75 worksurface cutout to drop wires below the worksurface to power access. Wire cutout is standard on all typicals.

T75D option is available to delete cutout on worksurfaces at no charge. Please specify when ordering.

## Honey T75 dimensions

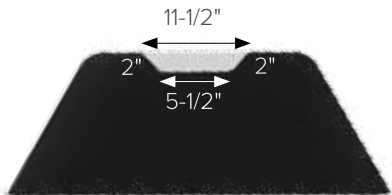

Panel workstation dimensions

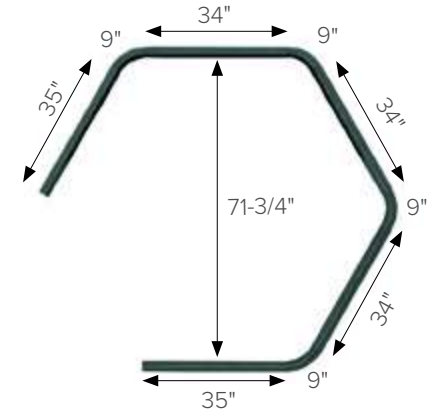
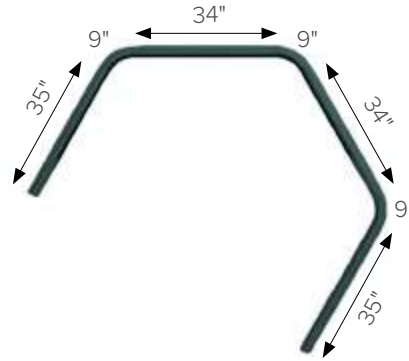
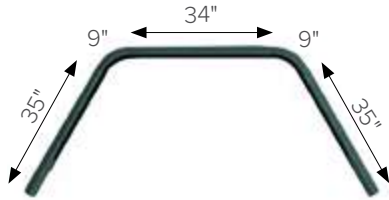

Height adjustable worksurface dimensions

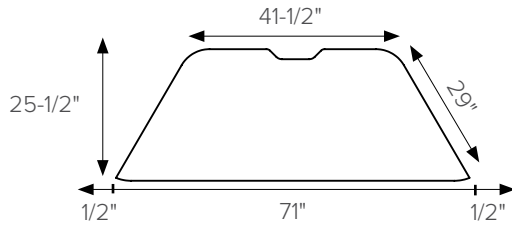

72" Height Adjustable Worksurface

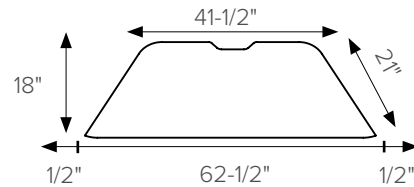

63-1/2" Height Adjustable Worksurface

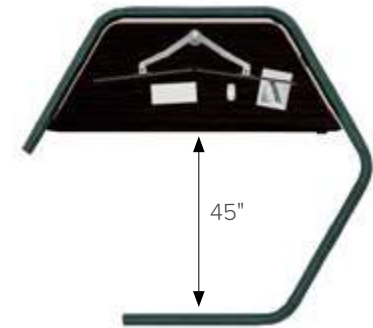

Fixed worksurface dimensions

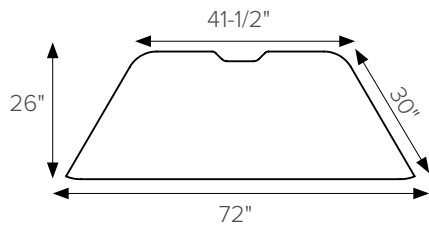

72" Fixed Worksurface

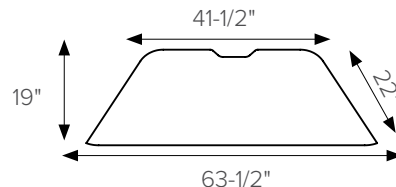

63-1/2" Fixed Height Worksurface



Honey workstations can be specified to meet New York electrical requirements. A flexible infeed, junction box and removable acrylic cover is included when specifying New York Power. The infeed and junction box are required to be on the Starter Panel at the first workstation next to a Single or Double Sided Power Panel. The customer will need to specify if the removable cover will need to be on the inside or outside of the workstation Starter Panel. NYPE: New York Power - \$425 list.

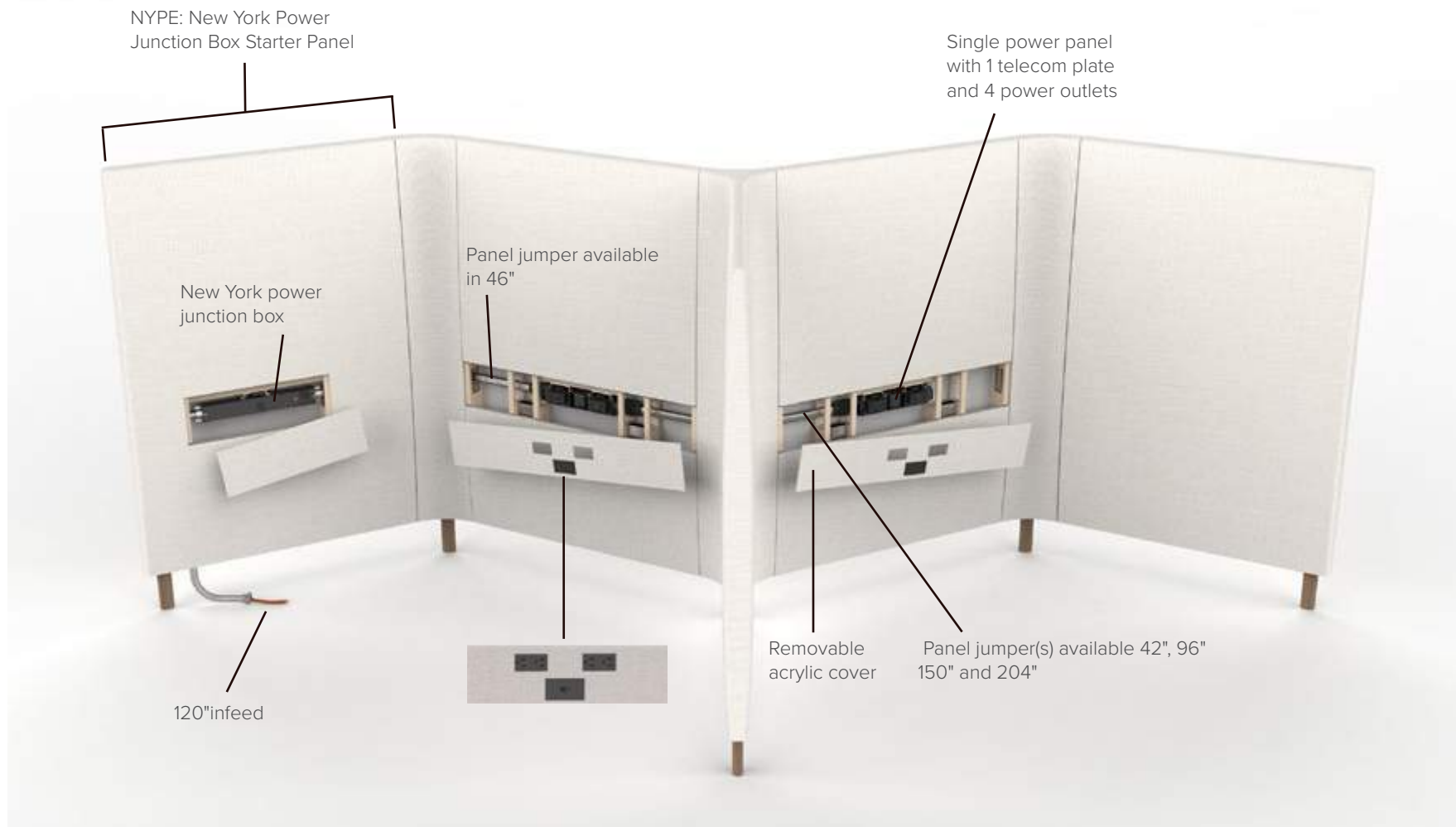

Rounded Starter Panels are not available with NYPE: New York Power Entry option.

\*Please check with general contractor to see if NYPE: New York Power option is required.

Honey workstations can be specified to meet West Coast electrical requirements. A Circuitrac energy management system and flexible infeed is included and must be specifying on a Starter Panel at the first workstation next to a Single or Double Sided Power Panel. The customer will need to specify if the removable cover will need to be on the inside or outside of the workstation Starter Panel. WCPE: West Coast Power - \$2,695.

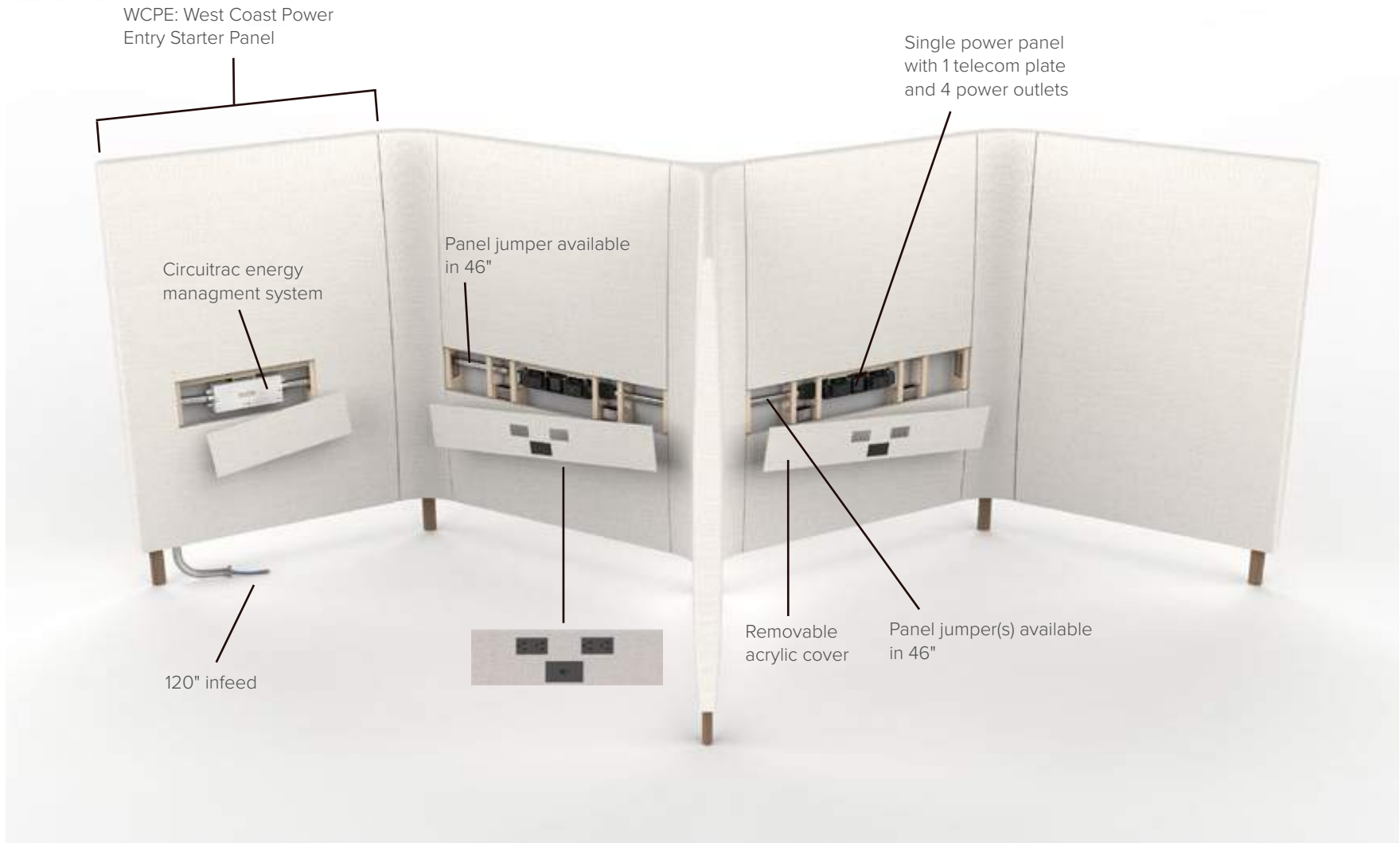

Rounded Starter Panels are not available with WCPE: West Coast Power option.

\*Please check with general contractor to see if WCPE: West Coast Power option is required.

Honey workstations can be specified with a Single or Double Sided Power Panel to meet Chicago electrical requirements. Chicago Power Panels include an electrical box inside Power Panels for a local electrician to wire receptacles and connectors. CSSPP: Single Sided Power Panel - \$25. CDSPP: Double Sided Power Panel - \$50.

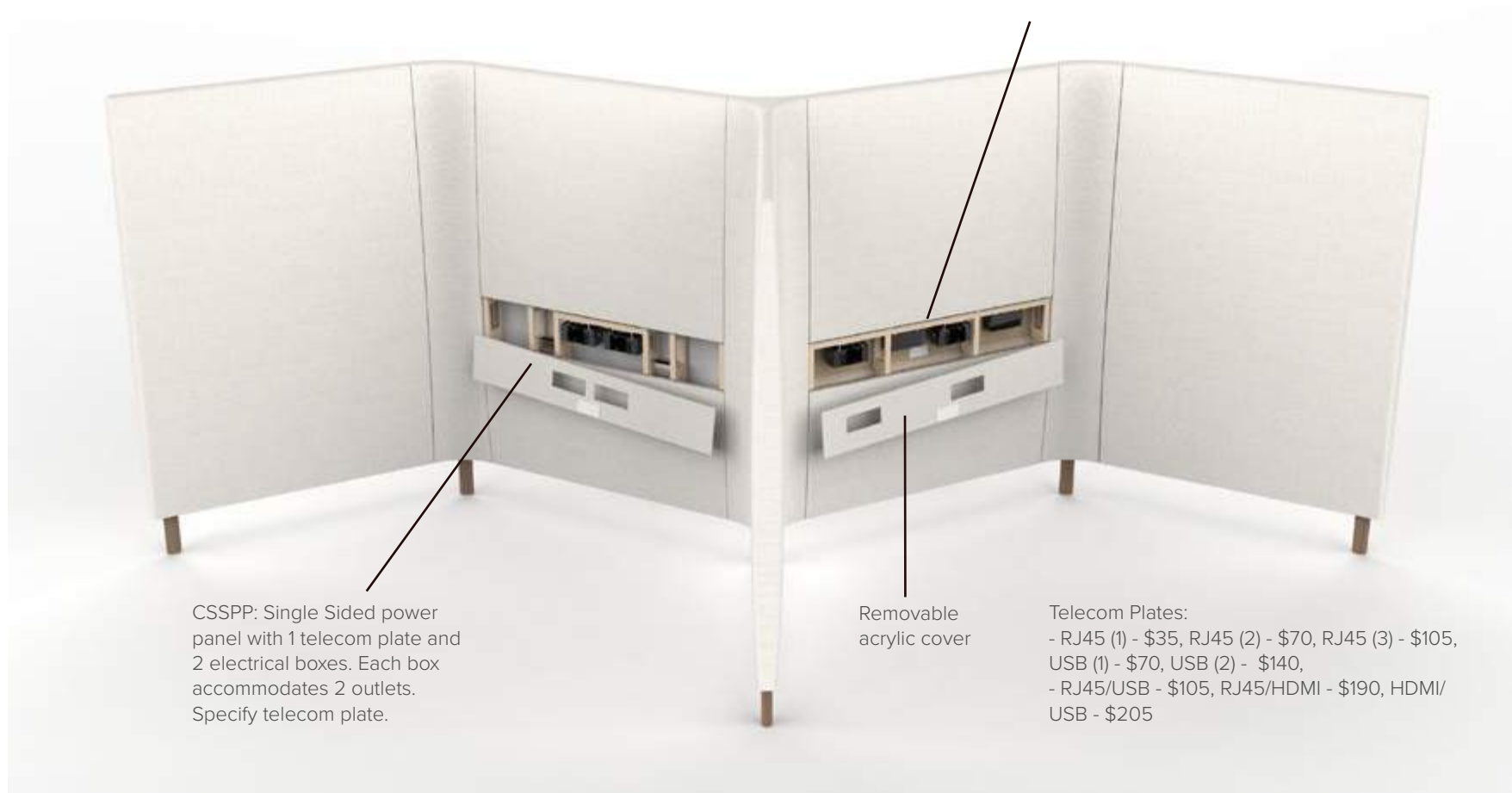

CDSPP: Double sided power panel with 1 telecom plate and 2 electrical boxes on each side. Each box accommodates 2 outlets. Specify 2 telecom plates.

CSSPP: Single Sided power panel with 1 telecom plate and 2 electrical boxes. Each box accommodates 2 outlets. Specify telecom plate.

Removable acrylic cover

Telecom Plates:  
 - RJ45 (1) - \$35, RJ45 (2) - \$70, RJ45 (3) - \$105,  
 USB (1) - \$70, USB (2) - \$140,  
 - RJ45/USB - \$105, RJ45/HDMI - \$190, HDMI/  
 USB - \$205

\*Please check with general contractor to see if Chicago Power is required.

### Interior drawer dimensions

UNIT DEPTH	DRAWER TYPE	OVERALL DIMENSIONS			INTERIOR DRAWER DIMENSIONS			NOTES
		W	D	H	W	D	H	
15-5/8" Letter	18" Box	13-1/8	16-1/16	4	12-1/8	15-1/16	3-7/16	Units less than 72"
	18" File	13-1/8	16-1/16	9-13/16	12-1/8	15-1/16	9-5/16	Units less than 72"
	10" Box	7-1/2	16-1/16	4	6-1/2	15-1/16	3-7/16	
	10" File	7-1/2	16-1/16	9-13/16	6-1/2	15-1/16	9-5/16	

### Filing reference

#### Filing for 10" depth units

7-1/2" Wide File Drawer - 16 1/16" Deep



Letter Side to Side

Mobile Pedestal and Tower

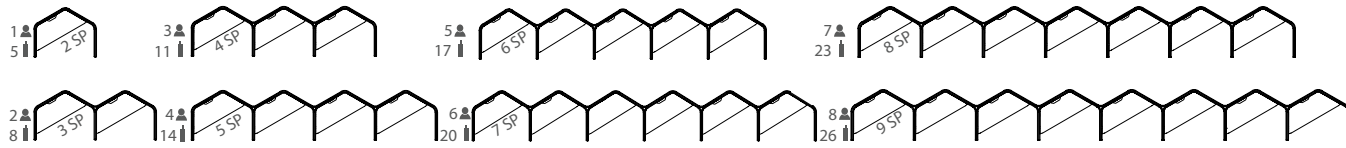

Number of Feet per Typical (MTL10 Option) "SP" Number of Starter Panels per Typical (RSP Option)

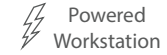
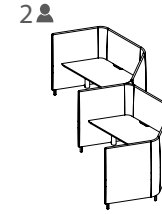

1 Select Model

w" x d" x h"	Weight	Standard Veneer Top Upholstered Panels - COM\$	Premium Veneer Top Upholstered Panels - COM\$	High Pressure Laminate Top Upholstered Panels - COM\$	Thermally Fused Laminate Top Upholstered Panels - COM\$
602 x 62 x 55	96	8 HNY60262HA571W 70057	"P" Option N/A	HNY60262HA571G 68449	HNY60262HA571M 65393
528 x 62 x 55	84	7 HNY52862HA571W 61493	"P" Option N/A	HNY52862HA571G 60086	HNY52862HA571M 57412
453 x 62 x 55	73	6 HNY45362HA571W 52929	"P" Option N/A	HNY45362HA571G 51723	HNY45362HA571M 49431
378 x 62 x 55	61	5 HNY37862HA571W 44365	"P" Option N/A	HNY37862HA571G 43360	HNY37862HA571M 41450
303 x 62 x 55	50	4 HNY30362HA571W 35801	"P" Option N/A	HNY30362HA571G 34997	HNY30362HA571M 33469
228 x 62 x 55	38	3 HNY22862HA571W 27237	"P" Option N/A	HNY22862HA571G 26634	HNY22862HA571M 25488
153 x 62 x 55	27	2 HNY15362HA571W 18673	"P" Option N/A	HNY15362HA571G 18271	HNY15362HA571M 17507
78 x 62 x 55	15	1 HNY7862HA571W 10109	"P" Option N/A	HNY7862HA571G 9908	HNY7862HA571M 9526

[Click Here for Graded in Pricing](#)

2 Select Finish

Click to view finishes

WWP	WOW
PO01	WNO
PO02	WSO
PO03	WNF(Natural Oak on Flat Cut)
PO07	WSF(Salted Oak on Flat Cut)
PO08	WSF(Salted Oak on Flat Cut)
PO09	WSF(Salted Oak on Flat Cut)
WBW	
WSW	
WEC	

3 Select Feet Finish

Click to view edges

WWP	WOW
PO01	WNO
PO02	WSO
PO03	
PO07	
PO08	
PO09	
WBW	
WSW	
WEC	

4 Select Edge

Click to view details

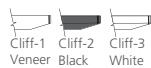

GEC	LW04
GNA +5%	LW05
GWL	LW06
LP01	
LF02	
LF03	
LN01	
LA02	
LW01	
LW02	

WWP	WOW
PO01	WNO
PO02	WSO
PO03	
PO07	
PO08	
PO09	
WBW	
WSW	
WEC	



MOC
MEC
MSW
MTW
MWL
MNA

WWP	WOW
PO01	WNO
PO02	WSO
PO03	
PO07	
PO08	
PO09	
WBW	
WSW	



[Click here to view statement of line](#)

Product Features

- 5" Solid wood feet - oval shape, ships KD
- 4 Power outlets with 1 telecom plate, see options below for telecom plate
- Adjustable height from 27" to 47.5" with a maximum weight capacity of 275 lbs.
- Lift standard in MFW White, optional MFB Black
- HNY7125WT163 Height Adjustable worksurfaces are included
- Wire management tray attaches to worksurface top, standard in MFW White, see premium Metal Finish for options
- T75 worksurface wire cutout is standard on all worksurfaces.(T75D: Delete cutout is optional)

Notes

- 1" Gap between worksurface and panels to drop wires below worksurface
- Metal parts include 5 year warranty
- Programmable height adjustable mechanism, motor includes 2 year warranty

Options

Accessories

- K28: Articulating Keyboard w/ Mouse - \$390
- K31-SK: Center drawer w/ skirt - \$310
- K31: Center drawer w/o skirt - \$205

Concealed Floor Power Infeed Cover

- PCEB: White Metal Finish concealed floor power infeed cover - \$150

Delete Top and Wire Tray

- DHAT: Delete height adjustable top. Deduct \$3845 Veneer(W), \$3644 High Pressure Laminate(G), \$3262 Thermally Fused Laminate(M) per top

Metal Feet

- MTL10: Replace solid wood feet with metal feet, standard MFW White - \$55 ea

Premium Metal Finish

- Specify premium Metal Finish. MFMB: Matte Black, MFS: Silver, MFSS: Salmon Sienna, MFSA: Surfin Aquavert, MFPS: Pistachio, MFOS: Oyster, MFNA: Navy, MFOL: Olive, MFGB: Grey Beige MFGG: Graphite Gray, MFG: Gray, MFGM:Matte Gold
- Premium Metal Finish for WMT Wire Management Tray - \$75 ea
- Premium Metal Finish for MTL10 Metal Feet - \$20 ea
- Premium Metal Finish for PCEB Concealed Floor Power Infeed Cover - \$35

Starter Panel

- RSP: Substitute round starter panel in place of flat starter panel. Must substitute all starters, priced per starter panel - \$83 each. See HNY3555SP888

Telecom Plates

- Each power unit has 1 plate. All telecom connectors sold separately.
- RJ45 (1) - \$55, RJ45 (2) - \$110, RJ45 (3) - \$165, USB (1) - \$70, USB (2) - \$140, RJ45/USB - \$125, RJ45/HDMI - \$210, HDMI/USB - \$205

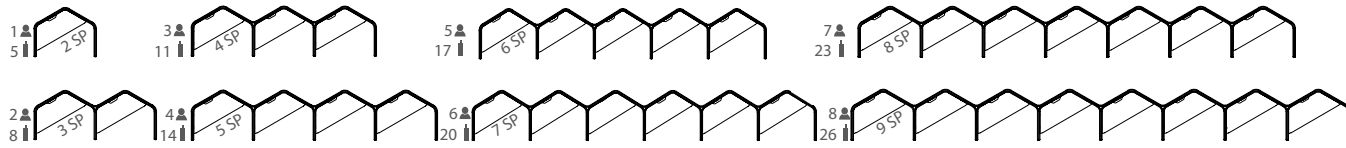

Number of Feet per Typical (MTL10 Option) "SP" Number of Starter Panels per Typical (RSP Option)

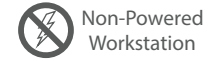
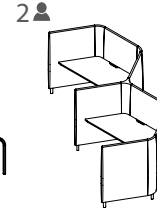

1 Select Model

w" x d" x h"	Weight	Standard Veneer Top Upholstered Panels - COM\$	Premium Veneer Top Upholstered Panels - COM\$
602 x 62 x 55	96	8 HNY60262FT571W 47826	"P" Option N/A
528 x 62 x 55	84	7 HNY52862FT571W 42024	"P" Option N/A
453 x 62 x 55	73	6 HNY45362FT571W 36222	"P" Option N/A
378 x 62 x 55	61	5 HNY37862FT571W 30420	"P" Option N/A
303 x 62 x 55	50	4 HNY30362FT571W 24618	"P" Option N/A
228 x 62 x 55	38	3 HNY22862FT571W 18816	"P" Option N/A
153 x 62 x 55	27	2 HNY15362FT571W 13014	"P" Option N/A
78 x 62 x 55	15	1 HNY7862FT571W 7212	"P" Option N/A

[Click Here for Graded in Pricing](#)

2 Select Finish

Click to view finishes

WWP	WOW
PO01	WNO
PO02	WSO
PO03	WNF(Natural Oak on Flat Cut)
PO07	WSF(Salted Oak on Flat Cut)
PO08	WSF(Salted Oak on Flat Cut)
PO09	WSF(Salted Oak on Flat Cut)
WBW	
WSW	
WEC	

3 Select Feet Finish

Click to view edges

WWP	WOW
PO01	WNO
PO02	WSO
PO03	
PO07	
PO08	
PO09	
WBW	
WSW	
WEC	

4 Select Edge

Click to view details

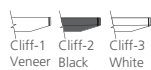

High Pressure Laminate Top Upholstered Panels - COM\$

HNY60262FT571G 46226	"P" Option N/A
HNY52862FT571G 40624	"P" Option N/A
HNY45362FT571G 35022	"P" Option N/A
HNY37862FT571G 29420	"P" Option N/A
HNY30362FT571G 23818	"P" Option N/A
HNY22862FT571G 18216	"P" Option N/A
HNY15362FT571G 12614	"P" Option N/A
HNY7862FT571G 7012	"P" Option N/A

GEC	LW04
GNA +5%	LW05
GWL	LW06
LP01	
LF02	
LF03	
LN01	
LA02	
LW01	
LW02	

WWP	WOW
PO01	WNO
PO02	WSO
PO03	
PO07	
PO08	
PO09	
WBW	
WSW	
WEC	



Thermally Fused Laminate Top Upholstered Panels - COM\$

HNY60262FT571M 43170	"P" Option N/A
HNY52862FT571M 37950	"P" Option N/A
HNY45362FT571M 32730	"P" Option N/A
HNY37862FT571M 27510	"P" Option N/A
HNY30362FT571M 22290	"P" Option N/A
HNY22862FT571M 17070	"P" Option N/A
HNY15362FT571M 11850	"P" Option N/A
HNY7862FT571M 6630	"P" Option N/A

MOC
MEC
MSW
MTW
MWL
MNA

WWP	WOW
PO01	WNO
PO02	WSO
PO03	
PO07	
PO08	
PO09	
WBW	
WSW	



[Click here to view statement of line](#)

Product Features

- 5" Solid wood feet - oval shape
- HNY7226WT162 Fixed Desk Height worksurfaces, 29" worksurface height
- Ships KD
- T75 worksurface wire cutout is standard on all worksurfaces.(T75D: Delete cutout is optional)

Options

Accessories

- K28: Articulating Keyboard w/ Mouse - \$390
- K31-SK: Center drawer w/ skirt - \$310
- K31: Center drawer w/o skirt - \$205

Concealed Floor Power Infeed Cover

- PCEB: White Metal Finish concealed floor power infeed cover - \$150

Delete Top

- DFT: Delete fixed top. Deduct \$1325 Veneer(W), \$1125 High Pressure Laminate (G), \$743 Thermally Fused Laminate (M) per top

Metal Feet

- MTL10: Replace solid wood feet with metal feet, standard MFW White - \$55 ea

Premium Metal Finish

- Specify premium Metal Finish. MFMB: Matte Black, MFS: Silver, MFSS: Salmon Sienna, MFSA: Surfing Aquavert, MFPS: Pistachio, MFOS: Oyster, MFNA: Navy, MFOL: Olive, MFGB: Grey Beige MFGG: Graphite Gray, MFG: Gray, MFGM:Matte Gold
- Premium Metal Finish for WMT Wire Management Tray - \$75 ea
- Premium Metal Finish for MTL10 Metal Feet - \$20 ea
- Premium Metal Finish for PCEB Concealed Floor Power Infeed Cover - \$35

Starter Panel

- RSP: Substitute round starter panel in place of flat starter panel. Must substitute all starters, priced per starter panel - \$83 each. See HNY3555SP888

Worksurface Height

- Modify worksurface height to bar height.
- THL-42: Position worksurface at bar height - N/C

Wire Tray

- WMT: Wire metal tray. Mounts under top and comes standard in MFW White - \$210

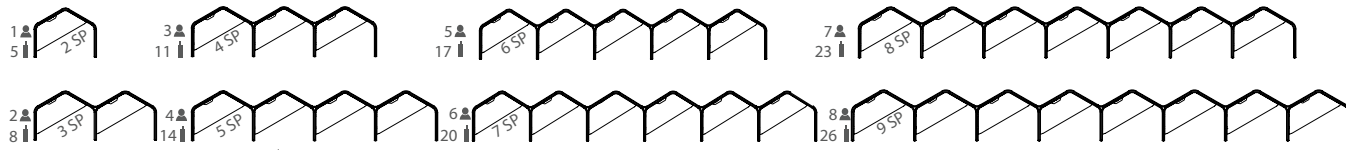

Number of Feet per Typical (MTL10 Option) "SP" Number of Starter Panels per Typical (RSP Option)

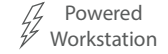
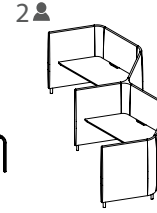

1 Select Model

w" x d" x h"	Weight	Standard Veneer Top Upholstered Panels - COM\$	Premium Veneer Top Upholstered Panels - COM\$
602 x 62 x 55	96	8 HNY60262FP571W 51729	"P" Option N/A
528 x 62 x 55	84	7 HNY52862FP571W 45456	"P" Option N/A
453 x 62 x 55	73	6 HNY45362FP571W 39183	"P" Option N/A
378 x 62 x 55	61	5 HNY37862FP571W 32910	"P" Option N/A
303 x 62 x 55	50	4 HNY30362FP571W 26637	"P" Option N/A
228 x 62 x 55	38	3 HNY22862FP571W 20364	"P" Option N/A
153 x 62 x 55	27	2 HNY15362FP571W 14091	"P" Option N/A
78 x 62 x 55	15	1 HNY7862FP571W 7818	"P" Option N/A

[Click Here for Graded in Pricing](#)

2 Select Finish

Click to view finishes

WWP	WOW
PO01	WNO
PO02	WSO
PO03	WNF(Natural Oak on Flat Cut)
PO07	WSF(Salted Oak on Flat Cut)
PO08	WSF(Salted Oak on Flat Cut)
PO09	WSF(Salted Oak on Flat Cut)
WBW	
WSW	
WEC	

3 Select Feet Finish

Click to view edges

WWP	WOW
PO01	WNO
PO02	WSO
PO03	
PO07	
PO08	
PO09	
WBW	
WSW	
WEC	

4 Select Edge

Click to view details

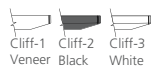

High Pressure Laminate Top Upholstered Panels - COM\$

HNY60262FP571G	50129
HNY52862FP571G	44056
HNY45362FP571G	37983
HNY37862FP571G	31910
HNY30362FP571G	25837
HNY22862FP571G	19764
HNY15362FP571G	13691
HNY7862FP571G	7618

GEC	LW04
GNA +5%	LW05
GWL	LW06
LP01	
LF02	
LF03	
LN01	
LA02	
LW01	
LW02	

WWP	WOW
PO01	WNO
PO02	WSO
PO03	
PO07	
PO08	
PO09	
WBW	
WSW	
WEC	



Thermally Fused Laminate Top Upholstered Panels - COM\$

HNY60262FP571M	47073
HNY52862FP571M	41382
HNY45362FP571M	35691
HNY37862FP571M	30000
HNY30362FP571M	24309
HNY22862FP571M	18618
HNY15362FP571M	12927
HNY7862FP571M	7236

MOC
MEC
MSW
MTW
MWL
MNA

WWP	WOW
PO01	WNO
PO02	WSO
PO03	
PO07	
PO08	
PO09	
WBW	
WSW	



[Click here to view statement of line](#)

Product Features

- HNY7226WT162 Fixed Desk Height worksurfaces, 29" worksurface height
- 5" Solid wood feet - oval shape
- 4 Power outlets with 1 telecom plate, see options below for telecom plate
- Ships KD
- Wire management tray attaches to worksurface top, standard in MFW White, see premium Metal Finish for options
- Hardwire infeed and jumpers are included in workstations
- T75 worksurface wire cutout is standard on all worksurfaces.(T75D: Delete cutout is optional)

Options

Accessories

- K28: Articulating Keyboard w/ Mouse - \$390
- K31-SK: Center drawer w/ skirt - \$310
- K31: Center drawer w/o skirt - \$205

Concealed Floor Power Infeed Cover

- PCEB: White Metal Finish concealed floor power infeed cover - \$150

Delete Top and Wire Tray

- DFP: Delete fixed top. Deduct \$1535 Veneer (W), \$1335 High Pressure Laminate (G), \$953 Thermally Fused Laminate (M) per top

Metal Feet

- MTL10: Replace solid wood feet with metal feet, standard MFW White - \$55 ea

Premium Metal Finish

- Specify premium Metal Finish. MFMB: Matte Black, MFS: Silver, MFSS: Salmon Sienna, MFSA: SurfIn Aquavert, MFPS: Pistachio, MFOS: Oyster, MFNA: Navy, MFOL: Olive, MFGB: Grey Beige MFGG: Graphite Gray, MFG: Gray, MFGM:Matte Gold
- Premium Metal Finish for WMT Wire Management Tray - \$75 ea
- Premium Metal Finish for MTL10 Metal Feet - \$20 ea
- Premium Metal Finish for PCEB Concealed Floor Power Infeed Cover - \$35

Starter Panel

- RSP: Substitute round starter panel in place of flat starter panel. Must substitute all starters, priced per starter panel - \$83 each. See HNY3555SP888

Telecom Plates

- Each power unit has 1 plate. All telecom connectors sold separately.
- RJ45 (1) - \$55, RJ45 (2) - \$110, RJ45 (3) - \$165, USB (1) - \$70, USB (2) - \$140, RJ45/USB - \$125, RJ45/HDMI - \$210, HDMI/USB - \$205

Worksurface Height

- THL-42: Modify worksurface height to bar height - N/C

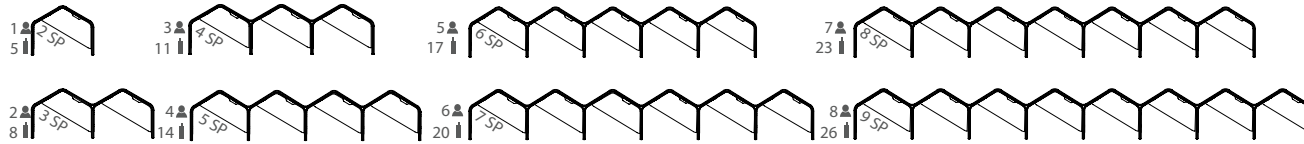

Number of Feet per Typical (MTL10 Option) "SP" Number of Starter Panels per Typical (RSP Option)

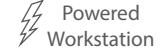
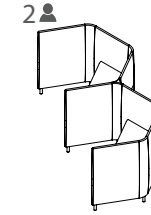

1 Select Model

w" x d" x h"	Weight	Standard Veneer Top Upholstered Panels - COM\$	Premium Veneer Top Upholstered Panels - COM\$	High Pressure Laminate Top Upholstered Panels - COM\$	Thermally Fused Laminate Top Upholstered Panels - COM\$
602 x 62 x 55	96	8 HNY60262HA572W 70057	"P" Option N/A	HNY60262HA572G 68449	HNY60262HA572M 65393
528 x 62 x 55	84	7 HNY52862HA572W 61493	"P" Option N/A	HNY52862HA572G 60086	HNY52862HA572M 57412
453 x 62 x 55	73	6 HNY45362HA572W 52929	"P" Option N/A	HNY45362HA572G 51723	HNY45362HA572M 49431
378 x 62 x 55	61	5 HNY37862HA572W 44365	"P" Option N/A	HNY37862HA572G 43360	HNY37862HA572M 41450
303 x 62 x 55	50	4 HNY30362HA572W 35801	"P" Option N/A	HNY30362HA572G 34997	HNY30362HA572M 33469
228 x 62 x 55	38	3 HNY22862HA572W 27237	"P" Option N/A	HNY22862HA572G 26634	HNY22862HA572M 25488
153 x 62 x 55	27	2 HNY15362HA572W 18673	"P" Option N/A	HNY15362HA572G 18271	HNY15362HA572M 17507
78 x 62 x 55	15	1 HNY7862HA572W 10109	"P" Option N/A	HNY7862HA572G 9908	HNY7862HA572M 9526

[Click Here for Graded in Pricing](#)

2 Select Finish

Click to view finishes

WWP	WOW
PO01	WNO
PO02	WSO
PO03	WNF(Natural Oak on Flat Cut)
PO07	WSF(Salted Oak on Flat Cut)
PO08	WSF(Salted Oak on Flat Cut)
PO09	WSF(Salted Oak on Flat Cut)
WBW	
WSW	
WEC	

3 Select Feet Finish

Click to view edges

WWP	WOW
PO01	WNO
PO02	WSO
PO03	
PO07	
PO08	
PO09	
WBW	
WSW	
WEC	

4 Select Edge

Click to view details

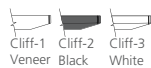

[Click here to view statement of line](#)

Product Features

- 5" Solid wood feet - oval shape, ships KD
- 4 Power outlets with 1 telecom plate, see options below for telecom plate
- Adjustable height from 27" to 47.5" with a maximum weight capacity of 275 lbs. Lift standard in MFW White, optional MFB Black
- HNY7125WT163 Height Adjustable worksurfaces are included
- Wire management tray attaches to worksurface top, standard in MFW White, see premium Metal Finish for options
- T75 worksurface wire cutout is standard on all worksurfaces.(T75D: Delete cutout is optional)

Notes

- 1" Gap between worksurface and panels to drop wires below worksurface
- Metal parts include 5 year warranty
- Programmable height adjustable mechanism, motor includes 2 year warranty

Options

Accessories

- K28: Articulating Keyboard w/ Mouse - \$390
- K31-SK: Center drawer w/ skirt - \$310
- K31: Center drawer w/o skirt - \$205

Concealed Floor Power Infeed Cover

- PCEB: White Metal Finish concealed floor power infeed cover - \$150

Delete Top and Wire Tray

- DHAT: Delete height adjustable top. Deduct \$3845 Veneer(W), \$3644 High Pressure Laminate(G), \$3262 Thermally Fused Laminate(M) per top

Metal Feet

- MTL10: Replace solid wood feet with metal feet, standard MFW White - \$55 ea

Premium Metal Finish

- Specify premium Metal Finish. MFMB: Matte Black, MFS: Silver, MFSS: Salmon Sienna, MFSA: Surfin Aquavert, MFPS: Pistachio, MFOS: Oyster, MFNA: Navy, MFOL: Olive, MFGB: Grey Beige MFGG: Graphite Gray, MFG: Gray, MFGM:Matte Gold
- Premium Metal Finish for WMT Wire Management Tray - \$75 ea
- Premium Metal Finish for MTL10 Metal Feet - \$20 ea
- Premium Metal Finish for PCEB Concealed Floor Power Infeed Cover - \$35

Starter Panel

- RSP: Substitute round starter panel in place of flat starter panel. Must substitute all starters, priced per starter panel - \$83 each. See HNY3555SP888

Telecom Plates

- Each power unit has 1 plate. All telecom connectors sold separately.
- RJ45 (1) - \$55, RJ45 (2) - \$110, RJ45 (3) - \$165, USB (1) - \$70, USB (2) - \$140, RJ45/USB - \$125, RJ45/HDMI - \$210, HDMI/USB - \$205



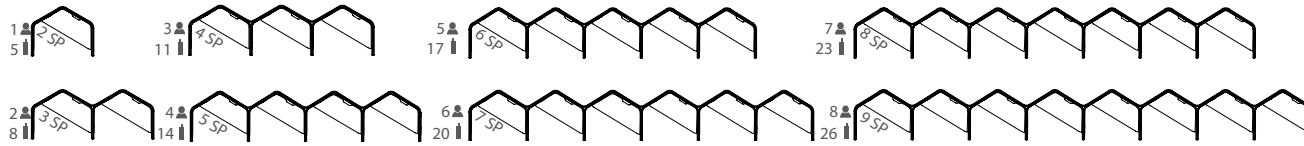

Number of Feet per Typical (MTL10 Option) "SP" Number of Starter Panels per Typical (RSP Option)

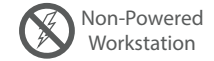
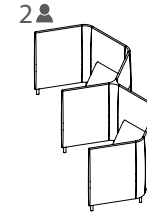

1 Select Model

w" x d" x h"	Weight	Standard Veneer Top Upholstered Panels - COM\$	Premium Veneer Top Upholstered Panels - COM\$
602 x 62 x 55	96	8 HNY60262FT572W 47826	"P" Option N/A
528 x 62 x 55	84	7 HNY52862FT572W 42024	"P" Option N/A
453 x 62 x 55	73	6 HNY45362FT572W 36222	"P" Option N/A
378 x 62 x 55	61	5 HNY37862FT572W 30420	"P" Option N/A
303 x 62 x 55	50	4 HNY30362FT572W 24618	"P" Option N/A
228 x 62 x 55	38	3 HNY22862FT572W 18816	"P" Option N/A
153 x 62 x 55	27	2 HNY15362FT572W 13014	"P" Option N/A
78 x 62 x 55	15	1 HNY7862FT572W 7212	"P" Option N/A

[Click Here for Graded in Pricing](#)

2 Select Finish

Click to view finishes

WWP	WOW
PO01	WNO
PO02	WSO
PO03	WNF(Natural Oak on Flat Cut)
PO07	WSF(Salted Oak on Flat Cut)
PO08	WSF(Salted Oak on Flat Cut)
PO09	WSF(Salted Oak on Flat Cut)
WBW	
WSW	
WEC	

3 Select Feet Finish

Click to view edges

WWP	WOW
PO01	WNO
PO02	WSO
PO03	
PO07	
PO08	
PO09	
WBW	
WSW	
WEC	

4 Select Edge

Click to view details

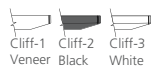

GEC	LW04
GNA +5%	LW05
GWL	LW06
LP01	
LF02	
LF03	
LN01	
LA02	
LW01	
LW02	

WWP	WOW
PO01	WNO
PO02	WSO
PO03	
PO07	
PO08	
PO09	
WBW	
WSW	
WEC	



MOC
MEC
MSW
MTW
MWL
MNA

WWP	WOW
PO01	WNO
PO02	WSO
PO03	
PO07	
PO08	
PO09	
WBW	
WSW	



[Click here to view statement of line](#)

Product Features

- 5" Solid wood feet - oval shape
- HNY7226WT162 Fixed Desk Height worksurfaces, 29" worksurface height
- Ships KD
- T75 worksurface wire cutout is standard on all worksurfaces.(T75D: Delete cutout is optional)

Options

Accessories

- K28: Articulating Keyboard w/ Mouse - \$390
- K31-SK: Center drawer w/ skirt - \$310
- K31: Center drawer w/o skirt - \$205

Concealed Floor Power Infeed Cover

- PCEB: White Metal Finish concealed floor power infeed cover - \$150

Delete Top

- DFT: Delete fixed top. Deduct \$1325 Veneer(W), \$1125 High Pressure Laminate (G), \$743 Thermally Fused Laminate (M) per top

Metal Feet

- MTL10: Replace solid wood feet with metal feet, standard MFW White - \$55 ea

Premium Metal Finish

- Specify premium Metal Finish. MFMB: Matte Black, MFS: Silver, MFSS: Salmon Sienna, MFSA: Surfing Aquavert, MFPS: Pistachio, MFOS: Oyster, MFNA: Navy, MFOL: Olive, MFGB: Grey Beige MFGG: Graphite Gray, MFG: Gray, MFGM:Matte Gold
- Premium Metal Finish for WMT Wire Management Tray - \$75 ea
- Premium Metal Finish for MTL10 Metal Feet - \$20 ea
- Premium Metal Finish for PCEB Concealed Floor Power Infeed Cover - \$35

Starter Panel

- RSP: Substitute round starter panel in place of flat starter panel. Must substitute all starters, priced per starter panel - \$83 each. See HNY3555SP888

Worksurface Height

- Modify worksurface height to bar height.
- THL-42: Position worksurface at bar height - N/C

Wire Tray

- WMT: Wire metal tray. Mounts under top and comes standard in MFW White - \$210

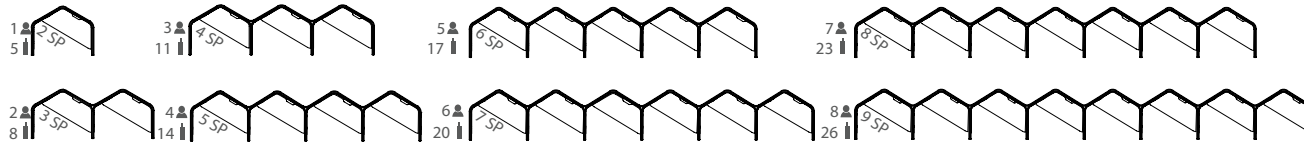

Number of Feet per Typical (MTL10 Option) "SP" Number of Starter Panels per Typical (RSP Option)

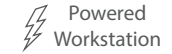
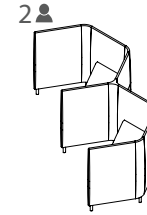

1 Select Model

w" x d" x h"	Weight	Standard Veneer Top Upholstered Panels - COM\$	Premium Veneer Top Upholstered Panels - COM\$
602 x 62 x 55	96	8 HNY60262FP572W 51729	"P" Option N/A
528 x 62 x 55	84	7 HNY52862FP572W 45456	"P" Option N/A
453 x 62 x 55	73	6 HNY45362FP572W 39183	"P" Option N/A
378 x 62 x 55	61	5 HNY37862FP572W 32910	"P" Option N/A
303 x 62 x 55	50	4 HNY30362FP572W 26637	"P" Option N/A
228 x 62 x 55	38	3 HNY22862FP572W 20364	"P" Option N/A
153 x 62 x 55	27	2 HNY15362FP572W 14091	"P" Option N/A
78 x 62 x 55	15	1 HNY7862FP572W 7818	"P" Option N/A

[Click Here for Graded in Pricing](#)

2 Select Finish

Click to view finishes

WWP	WOW
PO01	WNO
PO02	WSO
PO03	WNF(Natural Oak on Flat Cut)
PO07	WSF(Salted Oak on Flat Cut)
PO08	WSF(Salted Oak on Flat Cut)
PO09	WSF(Salted Oak on Flat Cut)
WBW	
WSW	
WEC	

3 Select Feet Finish

Click to view edges

WWP	WOW
PO01	WNO
PO02	WSO
PO03	
PO07	
PO08	
PO09	
WBW	
WSW	
WEC	

4 Select Edge

Click to view details



High Pressure Laminate Top Upholstered Panels - COM\$

HNY60262FP572G	50129
HNY52862FP572G	44056
HNY45362FP572G	37983
HNY37862FP572G	31910
HNY30362FP572G	25837
HNY22862FP572G	19764
HNY15362FP572G	13691
HNY7862FP572G	7618

GEC	LW04
GNA +5%	LW05
GWL	LW06
LP01	
LF02	
LF03	
LN01	
LA02	
LW01	
LW02	

WWP	WOW
PO01	WNO
PO02	WSO
PO03	
PO07	
PO08	
PO09	
WBW	
WSW	
WEC	

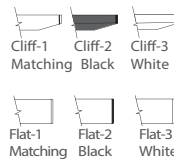

Thermally Fused Laminate Top Upholstered Panels - COM\$

HNY60262FP572M	47073
HNY52862FP572M	41382
HNY45362FP572M	35691
HNY37862FP572M	30000
HNY30362FP572M	24309
HNY22862FP572M	18618
HNY15362FP572M	12927
HNY7862FP572M	7236

MOC
MEC
MSW
MTW
MWL
MNA

WWP	WOW
PO01	WNO
PO02	WSO
PO03	
PO07	
PO08	
PO09	
WEC	
WBW	
WSW	



[Click here to view statement of line](#)

Product Features

- HNY7226WT162 Fixed Desk Height worksurfaces, 29" worksurface height
- 5" Solid wood feet - oval shape
- 4 Power outlets with 1 telecom plate, see options below for telecom plate
- Ships KD
- Wire management tray attaches to worksurface top, standard in MFW White, see premium Metal Finish for options
- Hardwire infeed and jumpers are included in workstations
- T75 worksurface wire cutout is standard on all worksurfaces.(T75D: Delete cutout is optional)

Options

Accessories

- K28: Articulating Keyboard w/ Mouse - \$390
- K31-SK: Center drawer w/ skirt - \$310
- K31: Center drawer w/o skirt - \$205

Concealed Floor Power Infeed Cover

- PCEB: White Metal Finish concealed floor power infeed cover - \$150

Delete Top and Wire Tray

- DFP: Delete fixed top. Deduct \$1535 Veneer (W), \$1335 High Pressure Laminate (G), \$953 Thermally Fused Laminate (M) per top

Metal Feet

- MTL10: Replace solid wood feet with metal feet, standard MFW White - \$55 ea

Premium Metal Finish

- Specify premium Metal Finish. MFMB: Matte Black, MFS: Silver, MFSS: Salmon Sienna, MFSA: Surfing Aquavert, MFPS: Pistachio, MFOS: Oyster, MFNA: Navy, MFOL: Olive, MFGB: Grey Beige MFGG: Graphite Gray, MFG: Gray, MFGM:Matte Gold
- Premium Metal Finish for WMT Wire Management Tray - \$75 ea
- Premium Metal Finish for MTL10 Metal Feet - \$20 ea
- Premium Metal Finish for PCEB Concealed Floor Power Infeed Cover - \$35

Starter Panel

- RSP: Substitute round starter panel in place of flat starter panel. Must substitute all starters, priced per starter panel - \$83 each. See HNY3555SP888

Telecom Plates

- Each power unit has 1 plate. All telecom connectors sold separately.
- RJ45 (1) - \$55, RJ45 (2) - \$110, RJ45 (3) - \$165, USB (1) - \$70, USB (2) - \$140, RJ45/USB - \$125, RJ45/HDMI - \$210, HDMI/USB - \$205

Worksurface Height

- THL-42: Modify worksurface height to bar height - N/C

Facing Diagonal Workstation Typical  
Position 1 with Height Adjustable Worksurface

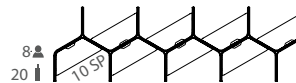
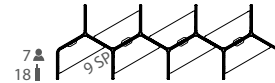
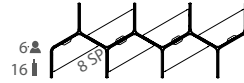
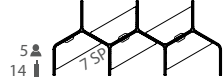
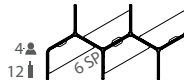
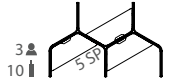
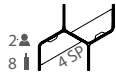

2

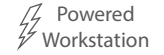
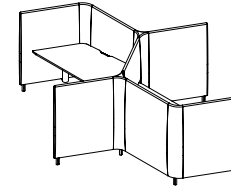

Number of Feet per Typical (MTL10 Option) "SP" Number of Starter Panels per Typical (RSP Option)

1 Select Model

w" x d" x h"	Weight	Standard Veneer Top Upholstered Panels - COM\$	Premium Veneer Top Upholstered Panels - COM\$	High Pressure Laminate Top Upholstered Panels - COM\$	Thermally Fused Laminate Top Upholstered Panels - COM\$
340 x 101 x 55	71	8 HNY340101HA573W 58841	"P" Option N/A	HNY340101HA573G 57233	HNY340101HA573M 54177
303 x 101 x 55	64	7 HNY303101HA573W 51918	"P" Option N/A	HNY303101HA573G 50511	HNY303101HA573M 47837
265 x 101 x 55	56	6 HNY265101HA573W 45266	"P" Option N/A	HNY265101HA573G 44060	HNY265101HA573M 41768
228 x 101 x 55	49	5 HNY228101HA573W 38343	"P" Option N/A	HNY228101HA573G 37338	HNY228101HA573M 35428
191 x 101 x 55	41	4 HNY191101HA573W 31691	"P" Option N/A	HNY191101HA573G 30887	HNY191101HA573M 29359
153 x 101 x 55	34	3 HNY153101HA573W 24768	"P" Option N/A	HNY153101HA573G 24165	HNY153101HA573M 23019
116 x 101 x 55	26	2 HNY116101HA573W 18116	"P" Option N/A	HNY116101HA573G 17714	HNY116101HA573M 16950

[Click Here for Graded in Pricing](#)

2 Select Finish

Click to view finishes

WWP	WOW
PO01	WNO
PO02	WSO
PO03	WNF(Natural Oak on Flat Cut)
PO07	WSF(Salted Oak on Flat Cut)
PO08	WSF(Salted Oak on Flat Cut)
PO09	WSF(Salted Oak on Flat Cut)
WBW	
WSW	
WEC	

3 Select Feet Finish

Click to view edges

WWP	WOW
PO01	WNO
PO02	WSO
PO03	
PO07	
PO08	
PO09	
WBW	
WSW	
WEC	

4 Select Edge

Click to view details

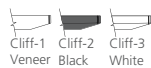

[Click here to view statement of line](#)

Product Features

- 5" Solid wood feet - oval shape, ships KD
- 4 Power outlets with 1 telecom plate, see options below for telecom plate
- Adjustable height from 27" to 47.5" with a maximum weight capacity of 275 lbs.
- Lift standard in MFW White, optional MFB Black
- HNY7125WT163 Height Adjustable worksurfaces are included
- Wire management tray attaches to worksurface top, standard in MFW White, see premium Metal Finish for options
- T75 worksurface wire cutout is standard on all worksurfaces.(T75D: Delete cutout is optional)

Notes

- 1" Gap between worksurface and panels to drop wires below worksurface
- Metal parts include 5 year warranty
- Programmable height adjustable mechanism, motor includes 2 year warranty

Options

Accessories

- K28: Articulating Keyboard w/ Mouse - \$390
- K31-SK: Center drawer w/ skirt - \$310
- K31: Center drawer w/o skirt - \$205

Concealed Floor Power Infeed Cover

- PCEB: White Metal Finish concealed floor power infeed cover - \$150

Delete Top and Wire Tray

- DHAT: Delete height adjustable top. Deduct \$3845 Veneer(W), \$3644 High Pressure Laminate(G), \$3262 Thermally Fused Laminate(M) per top

Metal Feet

- MTL10: Replace solid wood feet with metal feet, standard MFW White - \$55 ea

Premium Metal Finish

- Specify premium Metal Finish. MFMB: Matte Black, MFS: Silver, MFSS: Salmon Sienna, MFSA: Surfin Aquavert, MFPS: Pistachio, MFOS: Oyster, MFNA: Navy, MFOL: Olive, MFGB: Grey Beige MFGG: Graphite Gray, MFG: Gray, MFGM:Matte Gold
- Premium Metal Finish for WMT Wire Management Tray - \$75 ea
- Premium Metal Finish for MTL10 Metal Feet - \$20 ea
- Premium Metal Finish for PCEB Concealed Floor Power Infeed Cover - \$35

Starter Panel

- RSP: Substitute round starter panel in place of flat starter panel. Must substitute all starters, priced per starter panel - \$83 each. See HNY3555SP888

Telecom Plates

- Each power unit has 1 plate. All telecom connectors sold separately.
- RJ45 (1) - \$55, RJ45 (2) - \$110, RJ45 (3) - \$165, USB (1) - \$70, USB (2) - \$140, RJ45/USB - \$125, RJ45/HDMI - \$210, HDMI/USB - \$205

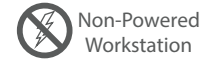
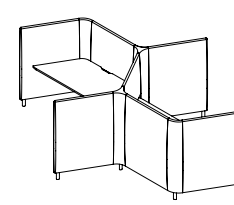
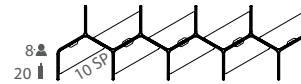
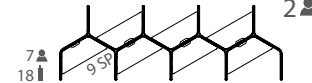
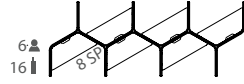
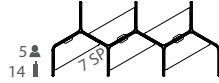
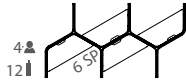
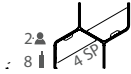

Number of Feet per Typical (MTL10 Option) "SP" Number of Starter Panels per Typical (RSP Option)

1 Select Model

w" x d" x h"	Weight	Standard Veneer Top Upholstered Panels - COM\$	Premium Veneer Top Upholstered Panels - COM\$	High Pressure Laminate Top Upholstered Panels - COM\$	Thermally Fused Laminate Top Upholstered Panels - COM\$
340 x 101 x 55	71	8 HNY340101FT573W 37836	"P" Option N/A	HNY340101FT573G 36236	HNY340101FT573M 33180
303 x 101 x 55	64	7 HNY303101FT573W 33616	"P" Option N/A	HNY303101FT573G 32216	HNY303101FT573M 29542
265 x 101 x 55	56	6 HNY265101FT573W 29396	"P" Option N/A	HNY265101FT573G 28196	HNY265101FT573M 25904
228 x 101 x 55	49	5 HNY228101FT573W 25176	"P" Option N/A	HNY228101FT573G 24176	HNY228101FT573M 22266
191 x 101 x 55	41	4 HNY191101FT573W 20956	"P" Option N/A	HNY191101FT573G 20156	HNY191101FT573M 18628
153 x 101 x 55	34	3 HNY153101FT573W 16736	"P" Option N/A	HNY153101FT573G 16136	HNY153101FT573M 14990
116 x 101 x 55	26	2 HNY116101FT573W 12516	"P" Option N/A	HNY116101FT573G 12116	HNY116101FT573M 11352

[Click Here for Graded in Pricing](#)

2 Select Finish

Click to view finishes

WWP	WOW
PO01	WNO
PO02	WSO
PO03	WNF(Natural Oak on Flat Cut)
PO07	WSF(Salted Oak on Flat Cut)
PO08	
PO09	
WBW	
WSW	
WEC	

3 Select Feet Finish

Click to view edges

WWP	WOW
PO01	WNO
PO02	WSO
PO03	
PO07	
PO08	
PO09	
WBW	
WSW	
WEC	

4 Select Edge

Click to view details

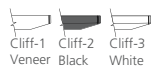

[Click here to view statement of line](#)

Product Features

- 5" Solid wood feet - oval shape
- HNY7226WT162 Fixed Desk Height worksurfaces, 29" worksurface height
- Ships KD
- T75 worksurface wire cutout is standard on all worksurfaces.(T75D: Delete cutout is optional)

Options

Accessories

- K28: Articulating Keyboard w/ Mouse - \$390
- K31-SK: Center drawer w/ skirt - \$310
- K31: Center drawer w/o skirt - \$205

Concealed Floor Power Infeed Cover

- PCEB: White Metal Finish concealed floor power infeed cover - \$150

Delete Top

- DFT: Delete fixed top. Deduct \$1325 Veneer(W), \$1125 High Pressure Laminate (G), \$743 Thermally Fused Laminate (M) per top

Metal Feet

- MTL10: Replace solid wood feet with metal feet, standard MFW White - \$55 ea

Premium Metal Finish

- Specify premium Metal Finish. MFMB: Matte Black, MFS: Silver, MFSS: Salmon Sienna, MFSA: Surfing Aquavert, MFPS: Pistachio, MFOS: Oyster, MFNA: Navy, MFOL: Olive, MFGB: Grey Beige MFGG: Graphite Gray, MFG: Gray, MFGM:Matte Gold
- Premium Metal Finish for WMT Wire Management Tray - \$75 ea
- Premium Metal Finish for MTL10 Metal Feet - \$20 ea
- Premium Metal Finish for PCEB Concealed Floor Power Infeed Cover - \$35

Starter Panel

- RSP: Substitute round starter panel in place of flat starter panel. Must substitute all starters, priced per starter panel - \$83 each. See HNY3555SP888

Worksurface Height

- Modify worksurface height to bar height.
- THL-42: Position worksurface at bar height - N/C

Wire Tray

- WMT: Wire metal tray. Mounts under top and comes standard in MFW White - \$210

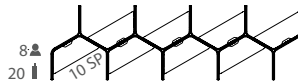
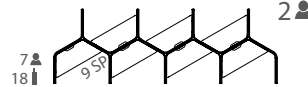
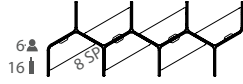
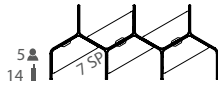
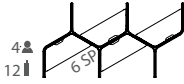
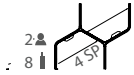

2

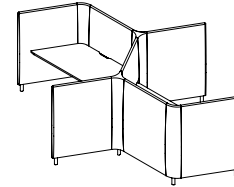

Number of Feet per Typical (MTL10 Option) "SP" Number of Starter Panels per Typical (RSP Option)

1 Select Model

w" x d" x h"	Weight	Standard Veneer Top Upholstered Panels - COM\$	Premium Veneer Top Upholstered Panels - COM\$	High Pressure Laminate Top Upholstered Panels - COM\$	Thermally Fused Laminate Top Upholstered Panels - COM\$
340 x 101 x 55	71	8 HNY340101FP573W 40513	"P" Option N/A	HNY340101FP573G 38913	HNY340101FP573M 35857
303 x 101 x 55	64	7 HNY303101FP573W 35881	"P" Option N/A	HNY303101FP573G 34481	HNY303101FP573M 31807
265 x 101 x 55	56	6 HNY265101FP573W 31520	"P" Option N/A	HNY265101FP573G 30320	HNY265101FP573M 28028
228 x 101 x 55	49	5 HNY228101FP573W 26888	"P" Option N/A	HNY228101FP573G 25888	HNY228101FP573M 23978
191 x 101 x 55	41	4 HNY191101FP573W 22527	"P" Option N/A	HNY191101FP573G 21727	HNY191101FP573M 20199
153 x 101 x 55	34	3 HNY153101FP573W 17895	"P" Option N/A	HNY153101FP573G 17295	HNY153101FP573M 16149
116 x 101 x 55	26	2 HNY116101FP573W 13534	"P" Option N/A	HNY116101FP573G 13134	HNY116101FP573M 12370

[Click Here for Graded in Pricing](#)

2 Select Finish

Click to view finishes

WWP	WOW
PO01	WNO
PO02	WSO
PO03	WNF(Natural Oak on Flat Cut)
PO07	WSF(Salted Oak on Flat Cut)
PO08	WSF(Salted Oak on Flat Cut)
PO09	WSF(Salted Oak on Flat Cut)
WBW	
WSW	
WEC	

3 Select Feet Finish

Click to view edges

WWP	WOW
PO01	WNO
PO02	WSO
PO03	
PO07	
PO08	
PO09	
WBW	
WSW	
WEC	

4 Select Edge

Click to view details



GEC	LW04
GNA +5%	LW05
GWL	LW06
LP01	
LF02	
LF03	
LN01	
LA02	
LW01	
LW02	

WWP	WOW
PO01	WNO
PO02	WSO
PO03	
PO07	
PO08	
PO09	
WBW	
WSW	
WEC	



MOC
MEC
MSW
MTW
MWL
MNA

WWP	WOW
PO01	WNO
PO02	WSO
PO03	
PO07	
PO08	
PO09	
WEC	
WBW	
WSW	



[Click here to view statement of line](#)

Product Features

- HNY7226WT162 Fixed Desk Height worksurfaces, 29" worksurface height
- 5" Solid wood feet - oval shape
- 4 Power outlets with 1 telecom plate, see options below for telecom plate
- Ships KD
- Wire management tray attaches to worksurface top, standard in MFW White, see premium Metal Finish for options
- Hardwire infeed and jumpers are included in workstations
- T75 worksurface wire cutout is standard on all worksurfaces.(T75D: Delete cutout is optional)

Options

Accessories

- K28: Articulating Keyboard w/ Mouse - \$390
- K31-SK: Center drawer w/ skirt - \$310
- K31: Center drawer w/o skirt - \$205

Concealed Floor Power Infeed Cover

- PCEB: White Metal Finish concealed floor power infeed cover - \$150

Delete Top and Wire Tray

- DFP: Delete fixed top. Deduct \$1535 Veneer (W), \$1335 High Pressure Laminate (G), \$953 Thermally Fused Laminate (M) per top

Metal Feet

- MTL10: Replace solid wood feet with metal feet, standard MFW White - \$55 ea

Premium Metal Finish

- Specify premium Metal Finish. MFMB: Matte Black, MFS: Silver, MFSS: Salmon Sienna, MFSA: Surfing Aquavert, MFPS: Pistachio, MFOS: Oyster, MFNA: Navy, MFOL: Olive, MFGB: Grey Beige MFGG: Graphite Gray, MFG: Gray, MFGM:Matte Gold
- Premium Metal Finish for WMT Wire Management Tray - \$75 ea
- Premium Metal Finish for MTL10 Metal Feet - \$20 ea
- Premium Metal Finish for PCEB Concealed Floor Power Infeed Cover - \$35

Starter Panel

- RSP: Substitute round starter panel in place of flat starter panel. Must substitute all starters, priced per starter panel - \$83 each. See HNY3555SP888

Telecom Plates

- Each power unit has 1 plate. All telecom connectors sold separately.
- RJ45 (1) - \$55, RJ45 (2) - \$110, RJ45 (3) - \$165, USB (1) - \$70, USB (2) - \$140, RJ45/USB - \$125, RJ45/HDMI - \$210, HDMI/USB - \$205

Worksurface Height

- THL-42: Modify worksurface height to bar height - N/C

Facing Diagonal Workstation Typical  
Position 2 Desk with Height Adjustable Worksurface

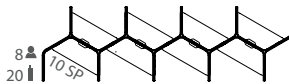
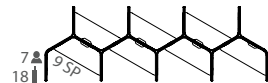
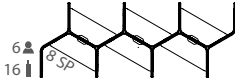
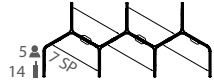
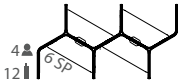
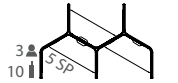

Number of Feet per Typical (MTL10 Option) "SP" Number of Starter Panels per Typical (RSP Option)

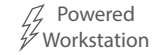
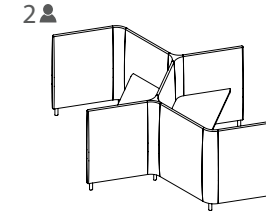

1 Select Model

w" x d" x h"	Weight	Standard Veneer Top Upholstered Panels - COM\$	Premium Veneer Top Upholstered Panels - COM\$
340 x 101 x 55	71	8 HNY340101HA574W 58570	"P" Option N/A
303 x 101 x 55	64	7 HNY303101HA574W 51918	"P" Option N/A
265 x 101 x 55	56	6 HNY265101HA574W 44995	"P" Option N/A
228 x 101 x 55	49	5 HNY228101HA574W 38343	"P" Option N/A
191 x 101 x 55	41	4 HNY191101HA574W 31420	"P" Option N/A
153 x 101 x 55	34	3 HNY153101HA574W 24768	"P" Option N/A
116 x 101 x 55	26	2 HNY116101HA574W 17845	"P" Option N/A

[Click Here for Graded in Pricing](#)

2 Select Finish

Click to view finishes

WWP	WOW
PO01	WNO
PO02	WSO
PO03	WNF(Natural Oak on Flat Cut)
PO07	WSF(Salted Oak on Flat Cut)
PO08	WSF(Salted Oak on Flat Cut)
PO09	WSF(Salted Oak on Flat Cut)
WBW	
WSW	
WEC	

3 Select Feet Finish

Click to view edges

WWP	WOW
PO01	WNO
PO02	WSO
PO03	
PO07	
PO08	
PO09	
WBW	
WSW	
WEC	

4 Select Edge

Click to view details



High Pressure Laminate Top Upholstered Panels - COM\$

HNY340101HA574G	56962
HNY303101HA574G	50511
HNY265101HA574G	43789
HNY228101HA574G	37338
HNY191101HA574G	30616
HNY153101HA574G	24165
HNY116101HA574G	17443

GEC	LW04
GNA +5%	LW05
GWL	LW06
LP01	
LF02	
LF03	
LN01	
LA02	
LW01	
LW02	

WWP	WOW
PO01	WNO
PO02	WSO
PO03	
PO07	
PO08	
PO09	
WBW	
WSW	
WEC	



Thermally Fused Laminate Top Upholstered Panels - COM\$

HNY340101HA574M	53906
HNY303101HA574M	47837
HNY265101HA574M	41497
HNY228101HA574M	35428
HNY191101HA574M	29088
HNY153101HA574M	23019
HNY116101HA574M	16679

MOC
MEC
MSW
MTW
MWL
MNA

WWP	WOW
PO01	WNO
PO02	WSO
PO03	
PO07	
PO08	
PO09	
WBW	
WSW	



[Click here to view statement of line](#)

Product Features

- 5" Solid wood feet - oval shape, ships KD
- 4 Power outlets with 1 telecom plate, see options below for telecom plate
- Adjustable height from 27" to 47.5" with a maximum weight capacity of 275 lbs. Lift standard in MFW White, optional MFB Black
- HNY7125WT163 Height Adjustable worksurfaces are included
- Wire management tray attaches to worksurface top, standard in MFW White, see premium Metal Finish for options
- T75 worksurface wire cutout is standard on all worksurfaces.(T75D: Delete cutout is optional)

Notes

- 1" Gap between worksurface and panels to drop wires below worksurface
- Metal parts include 5 year warranty
- Programmable height adjustable mechanism, motor includes 2 year warranty

Options

Accessories

- K28: Articulating Keyboard w/ Mouse - \$390
- K31-SK: Center drawer w/ skirt - \$310
- K31: Center drawer w/o skirt - \$205

Concealed Floor Power Infeed Cover

- PCEB: White Metal Finish concealed floor power infeed cover - \$150

Delete Top and Wire Tray

- DHAT: Delete height adjustable top. Deduct \$3845 Veneer(W), \$3644 High Pressure Laminate(G), \$3262 Thermally Fused Laminate(M) per top

Metal Feet

- MTL10: Replace solid wood feet with metal feet, standard MFW White - \$55 ea

Premium Metal Finish

- Specify premium Metal Finish. MFMB: Matte Black, MFS: Silver, MFSS: Salmon Sienna, MFSA: Surfin Aquavert, MFPS: Pistachio, MFOS: Oyster, MFNA: Navy, MFOL: Olive, MFGB: Grey Beige MFGG: Graphite Gray, MFG: Gray, MFGM:Matte Gold
- Premium Metal Finish for WMT Wire Management Tray - \$75 ea
- Premium Metal Finish for MTL10 Metal Feet - \$20 ea
- Premium Metal Finish for PCEB Concealed Floor Power Infeed Cover - \$35

Starter Panel

- RSP: Substitute round starter panel in place of flat starter panel. Must substitute all starters, priced per starter panel - \$83 each. See HNY3555SP888

Telecom Plates

- Each power unit has 1 plate. All telecom connectors sold separately.
- RJ45 (1) - \$55, RJ45 (2) - \$110, RJ45 (3) - \$165, USB (1) - \$70, USB (2) - \$140, RJ45/USB - \$125, RJ45/HDMI - \$210, HDMI/USB - \$205

Facing Diagonal Workstation Typical  
Position 2 Desk with Fixed Worksurface

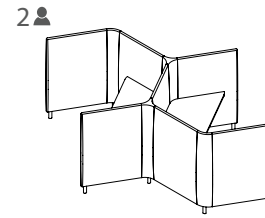
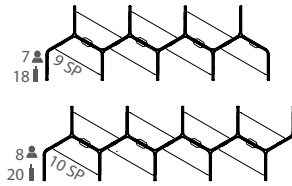
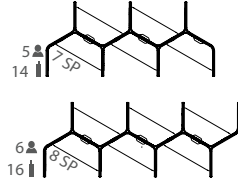
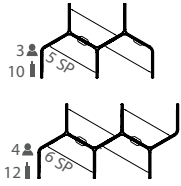

Number of Feet per Typical (MTL10 Option) "SP" Number of Starter Panels per Typical (RSP Option)

1 Select Model

w" x d" x h"	Weight	Standard Veneer Top Upholstered Panels - COM\$	Premium Veneer Top Upholstered Panels - COM\$
340 x 101 x 55	71	8 HNY340101FT574W 37836	"P" Option N/A
303 x 101 x 55	64	7 HNY303101FT574W 33616	"P" Option N/A
265 x 101 x 55	56	6 HNY265101FT574W 29396	"P" Option N/A
228 x 101 x 55	49	5 HNY228101FT574W 25176	"P" Option N/A
191 x 101 x 55	41	4 HNY191101FT574W 20956	"P" Option N/A
153 x 101 x 55	34	3 HNY153101FT574W 16736	"P" Option N/A
116 x 101 x 55	26	2 HNY116101FT574W 12516	"P" Option N/A

[Click Here for Graded in Pricing](#)

2 Select Finish

Click to view finishes

WWP	WOW
PO01	WNO
PO02	WSO
PO03	WNF(Natural Oak on Flat Cut)
PO08	WSF(Salted Oak on Flat Cut)
PO09	
WBW	
WSW	
WEC	

3 Select Feet Finish

Click to view edges

WWP	WOW
PO01	WNO
PO02	WSO
PO03	
PO07	
PO08	
PO09	
WBW	
WSW	
WEC	

4 Select Edge

Click to view details

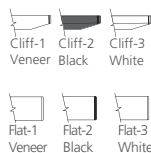

High Pressure Laminate Top Upholstered Panels - COM\$

HNY340101FT574G 36236	"P" Option N/A
HNY303101FT574G 32216	"P" Option N/A
HNY265101FT574G 28196	"P" Option N/A
HNY228101FT574G 24176	"P" Option N/A
HNY191101FT574G 20156	"P" Option N/A
HNY153101FT574G 16136	"P" Option N/A
HNY116101FT574G 12116	"P" Option N/A

GEC	LW04
GNA +5%	LW05
GWL	LW06
LP01	
LF02	
LF03	
LN01	
LA02	
LW01	
LW02	

WWP	WOW
PO01	WNO
PO02	WSO
PO03	
PO07	
PO08	
PO09	
WBW	
WSW	
WEC	

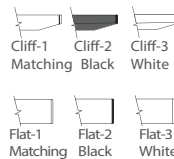

Thermally Fused Laminate Top Upholstered Panels - COM\$

HNY340101FT574M 33180	"P" Option N/A
HNY303101FT574M 29542	"P" Option N/A
HNY265101FT574M 25904	"P" Option N/A
HNY228101FT574M 22266	"P" Option N/A
HNY191101FT574M 18628	"P" Option N/A
HNY153101FT574M 14990	"P" Option N/A
HNY116101FT574M 11352	"P" Option N/A

MOC
MEC
MSW
MTW
MWL
MNA

WWP	WOW
PO01	WNO
PO02	WSO
PO03	
PO07	
PO08	
PO09	
WBW	
WSW	



[Click here to view statement of line](#)

Product Features

- 5" Solid wood feet - oval shape
- HNY7226WT162 Fixed Desk Height worksurfaces, 29" worksurface height
- Ships KD
- T75 worksurface wire cutout is standard on all worksurfaces.(T75D: Delete cutout is optional)

Options

Accessories

- K28: Articulating Keyboard w/ Mouse - \$390
- K31-SK: Center drawer w/ skirt - \$310
- K31: Center drawer w/o skirt - \$205

Concealed Floor Power Infeed Cover

- PCEB: White Metal Finish concealed floor power infeed cover - \$150

Delete Top

- DFT: Delete fixed top. Deduct \$1325 Veneer(W), \$1125 High Pressure Laminate (G), \$743 Thermally Fused Laminate (M) per top

Metal Feet

- MTL10: Replace solid wood feet with metal feet, standard MFW White - \$55 ea

Premium Metal Finish

- Specify premium Metal Finish. MFMB: Matte Black, MFS: Silver, MFSS: Salmon Sienna, MFSA: Surfing Aquavert, MFPS: Pistachio, MFOS: Oyster, MFNA: Navy, MFOL: Olive, MFGB: Grey Beige MFGG: Graphite Gray, MFG: Gray, MFGM:Matte Gold
- Premium Metal Finish for WMT Wire Management Tray - \$75 ea
- Premium Metal Finish for MTL10 Metal Feet - \$20 ea
- Premium Metal Finish for PCEB Concealed Floor Power Infeed Cover - \$35

Starter Panel

- RSP: Substitute round starter panel in place of flat starter panel. Must substitute all starters, priced per starter panel - \$83 each. See HNY3555SP888

Worksurface Height

- Modify worksurface height to bar height.
- THL-42: Position worksurface at bar height - N/C

Wire Tray

- WMT: Wire metal tray. Mounts under top and comes standard in MFW White - \$210

Facing Diagonal Workstation Typical  
Position 2 Desk with Power Fixed Worksurface

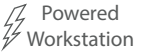
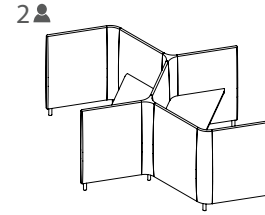
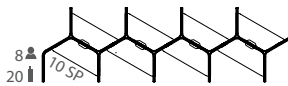
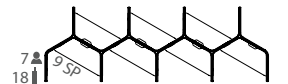
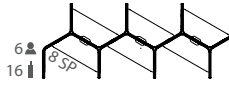
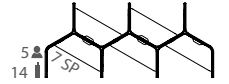
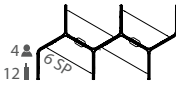
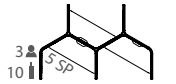
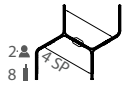

Number of Feet per Typical (MTL10 Option) "SP" Number of Starter Panels per Typical (RSP Option)

1 Select Model

w" x d" x h"	Weight	Standard Veneer Top Upholstered Panels - COM\$	Premium Veneer Top Upholstered Panels - COM\$
340 x 101 x 55	71	8 HNY340101FP574W 40242	"P" Option N/A
303 x 101 x 55	64	7 HNY303101FP574W 35881	"P" Option N/A
265 x 101 x 55	56	6 HNY265101FP574W 31249	"P" Option N/A
228 x 101 x 55	49	5 HNY228101FP574W 26888	"P" Option N/A
191 x 101 x 55	41	4 HNY191101FP574W 22256	"P" Option N/A
153 x 101 x 55	34	3 HNY153101FP574W 17895	"P" Option N/A
116 x 101 x 55	26	2 HNY116101FP574W 13263	"P" Option N/A

[Click Here for Graded in Pricing](#)

2 Select Finish

Click to view finishes

WWP	WOW
PO01	WNO
PO02	WSO
PO03	WNF(Natural Oak on Flat Cut)
PO07	WSF(Salted Oak on Flat Cut)
PO08	WSF(Salted Oak on Flat Cut)
PO09	WSF(Salted Oak on Flat Cut)
WBW	
WSW	
WEC	

3 Select Feet Finish

Click to view edges

WWP	WOW
PO01	WNO
PO02	WSO
PO03	
PO07	
PO08	
PO09	
WBW	
WSW	
WEC	

4 Select Edge

Click to view details

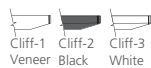

High Pressure Laminate Top Upholstered Panels - COM\$

HNY340101FP574G	38642
HNY303101FP574G	34481
HNY265101FP574G	30049
HNY228101FP574G	25888
HNY191101FP574G	21456
HNY153101FP574G	17295
HNY116101FP574G	12863

GEC	LW04
GNA +5%	LW05
GWL	LW06
LP01	
LF02	
LF03	
LN01	
LA02	
LW01	
LW02	

WWP	WOW
PO01	WNO
PO02	WSO
PO03	
PO07	
PO08	
PO09	
WBW	
WSW	
WEC	



Thermally Fused Laminate Top Upholstered Panels - COM\$

HNY340101FP574M	35586
HNY303101FP574M	31807
HNY265101FP574M	27757
HNY228101FP574M	23978
HNY191101FP574M	19928
HNY153101FP574M	16149
HNY116101FP574M	12099

MOC
MEC
MSW
MTW
MWL
MNA

WWP	WOW
PO01	WNO
PO02	WSO
PO03	
PO07	
PO08	
PO09	
WEC	
WBW	
WSW	



[Click here to view statement of line](#)

Product Features

- HNY7226WT162 Fixed Desk Height worksurfaces, 29" worksurface height
- 5" Solid wood feet - oval shape
- 4 Power outlets with 1 telecom plate, see options below for telecom plate
- Ships KD
- Wire management tray attaches to worksurface top, standard in MFW White, see premium Metal Finish for options
- Hardwire infeed and jumpers are included in workstations
- T75 worksurface wire cutout is standard on all worksurfaces.(T75D: Delete cutout is optional)

Options

Accessories

- K28: Articulating Keyboard w/ Mouse - \$390
- K31-SK: Center drawer w/ skirt - \$310
- K31: Center drawer w/o skirt - \$205

Concealed Floor Power Infeed Cover

- PCEB: White Metal Finish concealed floor power infeed cover - \$150

Delete Top and Wire Tray

- DFP: Delete fixed top. Deduct \$1535 Veneer (W), \$1335 High Pressure Laminate (G), \$953 Thermally Fused Laminate (M) per top

Metal Feet

- MTL10: Replace solid wood feet with metal feet, standard MFW White - \$55 ea

Premium Metal Finish

- Specify premium Metal Finish. MFMB: Matte Black, MFS: Silver, MFSS: Salmon Sienna, MFSA: Surfing Aquavert, MFPS: Pistachio, MFOS: Oyster, MFNA: Navy, MFOL: Olive, MFGB: Grey Beige MFGG: Graphite Gray, MFG: Gray, MFGM:Matte Gold
- Premium Metal Finish for WMT Wire Management Tray - \$75 ea
- Premium Metal Finish for MTL10 Metal Feet - \$20 ea
- Premium Metal Finish for PCEB Concealed Floor Power Infeed Cover - \$35

Starter Panel

- RSP: Substitute round starter panel in place of flat starter panel. Must substitute all starters, priced per starter panel - \$83 each. See HNY3555SP888

Telecom Plates

- Each power unit has 1 plate. All telecom connectors sold separately.
- RJ45 (1) - \$55, RJ45 (2) - \$110, RJ45 (3) - \$165, USB (1) - \$70, USB (2) - \$140, RJ45/USB - \$125, RJ45/HDMI - \$210, HDMI/USB - \$205

Worksurface Height

- THL-42: Modify worksurface height to bar height - N/C



4  
8

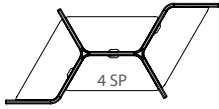

8  
14

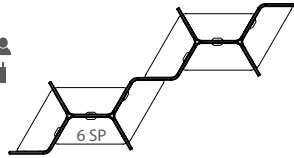

4  
8

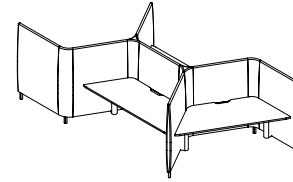

Number of Feet per Typical (MTL10 Option) "SP" Number of Starter Panels per Typical (RSP Option)

1 Select Model

Weight	Standard Veneer Top Upholstered Panels - COM\$
295 x 153 x 55	8 HNY295153HA575W 51214
166 x 78 x 55	4 HNY16678HA575W 26101

Premium Veneer Top Upholstered Panels - COM\$
"P" Option N/A
"P" Option N/A

High Pressure Laminate Top Upholstered Panels - COM\$
HNY295153HA575G 49606
HNY16678HA575G 25297

Thermally Fused Laminate Top Upholstered Panels - COM\$
HNY295153HA575M 46550
HNY16678HA575M 23769

[Click here to view statement of line](#)

Product Features

- 5" Solid wood feet - oval shape, ships KD
- 4 Power outlets with 1 telecom plate, see options below for telecom plate
- Adjustable height from 27" to 47.5" with a maximum weight capacity of 275 lbs.
- Lift standard in MFW White, optional MFB Black
- HNY7125WT163 Height Adjustable worksurfaces are included
- Wire management tray attaches to worksurface top, standard in MFW White, see premium Metal Finish for options
- T75 worksurface wire cutout is standard on all worksurfaces.(T75D: Delete cutout is optional)

Notes

- 1" Gap between worksurface and panels to drop wires below worksurface
- Metal parts include 5 year warranty
- Programmable height adjustable mechanism, motor includes 2 year warranty

Options

Accessories

- K28: Articulating Keyboard w/ Mouse - \$390
- K31-SK: Center drawer w/ skirt - \$310
- K31: Center drawer w/o skirt - \$205

Concealed Floor Power Infeed Cover

- PCEB: White Metal Finish concealed floor power infeed cover - \$150

Delete Top and Wire Tray

- DHAT: Delete height adjustable top. Deduct \$3845 Veneer(W), \$3644 High Pressure Laminate(G), \$3262 Thermally Fused Laminate(M) per top

Metal Feet

- MTL10: Replace solid wood feet with metal feet, standard MFW White - \$55 ea

Premium Metal Finish

- Specify premium Metal Finish. MFMB: Matte Black, MFS: Silver, MFSS: Salmon Sienna, MFSA: Surfing Aquavert, MFPS: Pistachio, MFOS: Oyster, MFNA: Navy, MFOL: Olive, MFGB: Grey Beige MFGG: Graphite Gray, MFG: Gray, MFGM:Matte Gold
- Premium Metal Finish for WMT Wire Management Tray - \$75 ea
- Premium Metal Finish for MTL10 Metal Feet - \$20 ea
- Premium Metal Finish for PCEB Concealed Floor Power Infeed Cover - \$35

Starter Panel

- RSP: Substitute round starter panel in place of flat starter panel. Must substitute all starters, priced per starter panel - \$83 each. See HNY3555SP888

Telecom Plates

- Each power unit has 1 plate. All telecom connectors sold separately.
- RJ45 (1) - \$55, RJ45 (2) - \$110, RJ45 (3) - \$165, USB (1) - \$70, USB (2) - \$140, RJ45/USB - \$125, RJ45/HDMI - \$210, HDMI/USB - \$205

[Click Here for Graded in Pricing](#)

2 Select Finish

Click to view finishes

WWP	WOW
PO01	WNO
PO02	WSO
PO03	WNF(Natural Oak on Flat Cut)
PO07	WSF(Salted Oak on Flat Cut)
PO08	WSF(Salted Oak on Flat Cut)
PO09	WSF(Salted Oak on Flat Cut)
WBW	
WSW	
WEC	

3 Select Feet Finish

Click to view edges

WWP	WOW
PO01	WNO
PO02	WSO
PO03	
PO07	
PO08	
PO09	
WBW	
WSW	
WEC	

4 Select Edge

Click to view details



4  
8

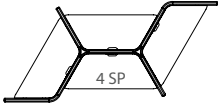

8  
14

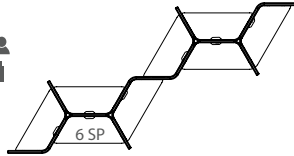

4  
8

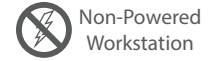
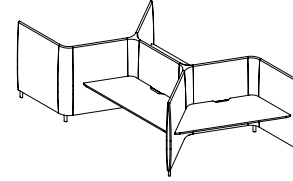

Number of Feet per Typical (MTL10 Option) "SP" Number of Starter Panels per Typical (RSP Option)

1 Select Model

Weight	Standard Veneer Top Upholstered Panels - COM\$
w" x d" x h"	
295 x 153 x 55	49 8 HNY295153FT575W 30336
166 x 78 x 55	26 4 HNY16678FT575W 15624

Premium Veneer Top Upholstered Panels - COM\$

"P" Option N/A  
"P" Option N/A

High Pressure Laminate Top Upholstered Panels - COM\$

HNY295153FT575G 28736  
HNY16678FT575G 14824

Thermally Fused Laminate Top Upholstered Panels - COM\$

HNY295153FT575M 25680  
HNY16678FT575M 13296

Product Features

- 5" Solid wood feet - oval shape
- HNY7226WT162 Fixed Desk Height worksurfaces, 29" worksurface height
- Ships KD
- T75 worksurface wire cutout is standard on all worksurfaces.(T75D: Delete cutout is optional)

Options

Accessories

- K28: Articulating Keyboard w/ Mouse - \$390
- K31-SK: Center drawer w/ skirt - \$310
- K31: Center drawer w/o skirt - \$205

Concealed Floor Power Infeed Cover

- PCEB: White Metal Finish concealed floor power infeed cover - \$150

Delete Top

- DFT: Delete fixed top. Deduct \$1325 Veneer(W), \$1125 High Pressure Laminate (G), \$743 Thermally Fused Laminate (M) per top

Metal Feet

- MTL10: Replace solid wood feet with metal feet, standard MFW White - \$55 ea

Premium Metal Finish

- Specify premium Metal Finish. MFMB: Matte Black, MFS: Silver, MFSS: Salmon Sienna, MFSA: Surfing Aquavert, MFPS: Pistachio, MFOS: Oyster, MFNA: Navy, MFOL: Olive, MFGB: Grey Beige MFGG: Graphite Gray, MFG: Gray, MFGM:Matte Gold
- Premium Metal Finish for WMT Wire Management Tray - \$75 ea
- Premium Metal Finish for MTL10 Metal Feet - \$20 ea
- Premium Metal Finish for PCEB Concealed Floor Power Infeed Cover - \$35

Starter Panel

- RSP: Substitute round starter panel in place of flat starter panel. Must substitute all starters, priced per starter panel - \$83 each. See HNY3555SP888

Worksurface Height

- Modify worksurface height to bar height.
- THL-42: Position worksurface at bar height - N/C

Wire Tray

- WMT: Wire metal tray. Mounts under top and comes standard in MFW White - \$210

[Click Here for Graded in Pricing](#)

2 Select Finish

Click to view finishes

WWP	WOW
PO01	WNO
PO02	WSO
PO03	WNF(Natural Oak on Flat Cut)
PO07	WSF(Salted Oak on Flat Cut)
PO08	
PO09	
WBW	
WSW	
WEC	

3 Select Feet Finish

Click to view edges

WWP	WOW
PO01	WNO
PO02	WSO
PO03	
PO07	
PO08	
PO09	
WBW	
WSW	
WEC	

4 Select Edge

Click to view details

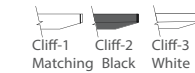

4  
8

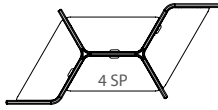

8  
14

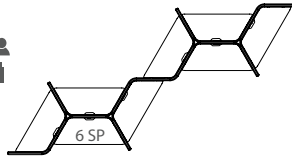

4  
8

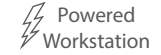
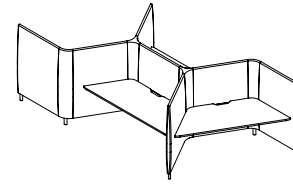

Number of Feet per Typical (MTL10 Option) "SP" Number of Starter Panels per Typical (RSP Option)

1 Select Model

Weight	Standard Veneer Top Upholstered Panels - COM\$
295 x 153 x 55	8 HNY295153FP575W 32886
166 x 78 x 55	4 HNY16678FP575W 16937

Premium Veneer Top Upholstered Panels - COM\$

"P" Option N/A  
"P" Option N/A

High Pressure Laminate Top Upholstered Panels - COM\$

HNY295153FP575G 31286  
HNY16678FP575G 16137

Thermally Fused Laminate Top Upholstered Panels - COM\$

HNY295153FP575M 28230  
HNY16678FP575M 14609

Product Features

- HNY7226WT162 Fixed Desk Height worksurfaces, 29" worksurface height
- 5" Solid wood feet - oval shape
- 4 Power outlets with 1 telecom plate, see options below for telecom plate
- Ships KD
- Wire management tray attaches to worksurface top, standard in MFW White, see premium Metal Finish for options
- Hardwire infeed and jumpers are included in workstations
- T75 worksurface wire cutout is standard on all worksurfaces.(T75D: Delete cutout is optional)

Options

Accessories

- K28: Articulating Keyboard w/ Mouse - \$390
- K31-SK: Center drawer w/ skirt - \$310
- K31: Center drawer w/o skirt - \$205

Concealed Floor Power Infeed Cover

- PCEB: White Metal Finish concealed floor power infeed cover - \$150

Delete Top and Wire Tray

- DFP: Delete fixed top. Deduct \$1535 Veneer (W), \$1335 High Pressure Laminate (G), \$953 Thermally Fused Laminate (M) per top

Metal Feet

- MTL10: Replace solid wood feet with metal feet, standard MFW White - \$55 ea

Premium Metal Finish

- Specify premium Metal Finish. MFMB: Matte Black, MFS: Silver, MFSS: Salmon Sienna, MFSA: Surfin Aquavert, MFPS: Pistachio, MFOS: Oyster, MFNA: Navy, MFOL: Olive, MFGB: Grey Beige MFGG: Graphite Gray, MFG: Gray, MFGM:Matte Gold
- Premium Metal Finish for WMT Wire Management Tray - \$75 ea
- Premium Metal Finish for MTL10 Metal Feet - \$20 ea
- Premium Metal Finish for PCEB Concealed Floor Power Infeed Cover - \$35

Starter Panel

- RSP: Substitute round starter panel in place of flat starter panel. Must substitute all starters, priced per starter panel - \$83 each. See HNY3555SP888

Telecom Plates

- Each power unit has 1 plate. All telecom connectors sold separately.
- RJ45 (1) - \$55, RJ45 (2) - \$110, RJ45 (3) - \$165, USB (1) - \$70, USB (2) - \$140, RJ45/USB - \$125, RJ45/HDMI - \$210, HDMI/USB - \$205

Worksurface Height

- THL-42: Modify worksurface height to bar height - N/C

[Click Here for Graded in Pricing](#)

2 Select Finish

Click to view finishes

WWP	WOW
PO01	WNO
PO02	WSO
PO03	WNF(Natural Oak on Flat Cut)
PO07	WSF(Salted Oak on Flat Cut)
PO08	WSF(Salted Oak on Flat Cut)
PO09	WSF(Salted Oak on Flat Cut)
WBW	
WSW	
WEC	

3 Select Feet Finish

Click to view edges

WWP	WOW
PO01	WNO
PO02	WSO
PO03	
PO07	
PO08	
PO09	
WBW	
WSW	
WEC	

4 Select Edge

Click to view details

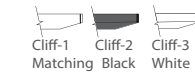
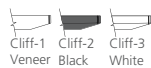

# DARRAN

# Honey

## Inline Hexagon Workstation Typical Position 1 Desk with Height Adjustable Worksurface

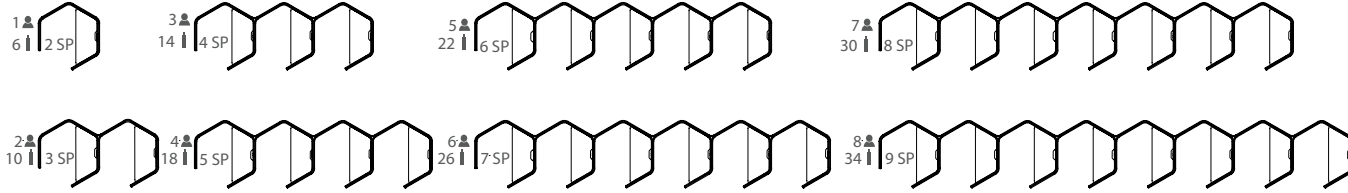

Number of Feet per Typical (MTL10 Option) "SP" Number of Starter Panels per Typical (RSP Option)

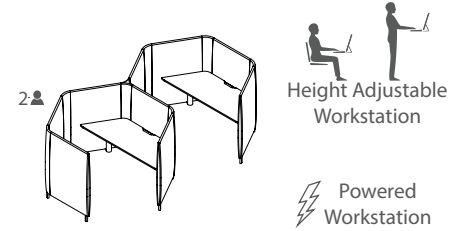

### 1 Select Model

w" x d" x h"	Weight	Standard Veneer Top Upholstered Panels - COM\$	Premium Veneer Top Upholstered Panels - COM\$	High Pressure Laminate Top Upholstered Panels - COM\$	Thermally Fused Laminate Top Upholstered Panels - COM\$
602 x 86 x 55	128	8 HNY60286HA576W 83710	"P" Option N/A	HNY60286HA576G 82102	HNY60286HA576M 79046
528 x 86 x 55	112	7 HNY52886HA576W 73430	"P" Option N/A	HNY52886HA576G 72023	HNY52886HA576M 69349
453 x 86 x 55	97	6 HNY45386HA576W 63150	"P" Option N/A	HNY45386HA576G 61944	HNY45386HA576M 59652
378 x 86 x 55	81	5 HNY37886HA576W 52870	"P" Option N/A	HNY37886HA576G 51865	HNY37886HA576M 49955
303 x 86 x 55	66	4 HNY30386HA576W 42590	"P" Option N/A	HNY30386HA576G 41786	HNY30386HA576M 40258
228 x 86 x 55	50	3 HNY22886HA576W 32310	"P" Option N/A	HNY22886HA576G 31707	HNY22886HA576M 30561
153 x 86 x 55	35	2 HNY15386HA576W 22030	"P" Option N/A	HNY15386HA576G 21628	HNY15386HA576M 20864
78 x 86 x 55	19	1 HNY7886HA576W 11750	"P" Option N/A	HNY7886HA576G 11549	HNY7886HA576M 11167

### 2 Select Finish

Click to view finishes

WWP	WOW
PO01	WNO
PO02	WSO
PO03	WNF(Natural Oak on Flat Cut)
PO07	WSF(Salted Oak on Flat Cut)
PO08	WSF(Salted Oak on Flat Cut)
PO09	WSF(Salted Oak on Flat Cut)
WBW	
WSW	
WEC	

### 3 Select Feet Finish

Click to view edges

WWP	WOW
PO01	WNO
PO02	WSO
PO03	
PO07	
PO08	
PO09	
WBW	
WSW	
WEC	

### 4 Select Edge

Click to view details

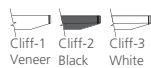

GEC	LW04
GNA +5%	LW05
GWL	LW06
LP01	
LF02	
LF03	
LN01	
LA02	
LW01	
LW02	

WWP	WOW
PO01	WNO
PO02	WSO
PO03	
PO07	
PO08	
PO09	
WBW	
WSW	
WEC	



MOC
MEC
MSW
MTW
MWL
MNA

WWP	WOW
PO01	WNO
PO02	WSO
PO03	
PO07	
PO08	
PO09	
WBW	
WSW	



Click here to view statement of line

### Product Features

- 5" Solid wood feet - oval shape, ships KD
- 4 Power outlets with 1 telecom plate, see options below for telecom plate
- Adjustable height from 27" to 47.5" with a maximum weight capacity of 275 lbs.
- Lift standard in MFW White, optional MFB Black
- HNY7125WT163 Height Adjustable worksurfaces are included
- Wire management tray attaches to worksurface top, standard in MFW White, see premium Metal Finish for options
- T75 worksurface wire cutout is standard on all worksurfaces.(T75D: Delete cutout is optional)

### Notes

- 1" Gap between worksurface and panels to drop wires below worksurface
- Metal parts include 5 year warranty
- Programmable height adjustable mechanism, motor includes 2 year warranty

### Options

#### Accessories

- K28: Articulating Keyboard w/ Mouse - \$390
- K31-SK: Center drawer w/ skirt - \$310
- K31: Center drawer w/o skirt - \$205

#### Concealed Floor Power Infeed Cover

- PCEB: White Metal Finish concealed floor power infeed cover - \$150

#### Delete Top and Wire Tray

- DHAT: Delete height adjustable top. Deduct \$3845 Veneer(W), \$3644 High Pressure Laminate(G), \$3262 Thermally Fused Laminate(M) per top

#### Metal Feet

- MTL10: Replace solid wood feet with metal feet, standard MFW White - \$55 ea

#### Premium Metal Finish

- Specify premium Metal Finish. MFMB: Matte Black, MFS: Silver, MFSS: Salmon Sienna, MFSA: Surfin Aquavert, MFPS: Pistachio, MFOS: Oyster, MFNA: Navy, MFOL: Olive, MFGB: Grey Beige MFGG: Graphite Gray, MFG: Gray, MFGM:Matte Gold
- Premium Metal Finish for WMT Wire Management Tray - \$75 ea
- Premium Metal Finish for MTL10 Metal Feet - \$20 ea
- Premium Metal Finish for PCEB Concealed Floor Power Infeed Cover - \$35

#### Starter Panel

- RSP: Substitute round starter panel in place of flat starter panel. Must substitute all starters, priced per starter panel - \$83 each. See HNY3555SP888

#### Telecom Plates

- Each power unit has 1 plate. All telecom connectors sold separately.
- RJ45 (1) - \$55, RJ45 (2) - \$110, RJ45 (3) - \$165, USB (1) - \$70, USB (2) - \$140, RJ45/USB - \$125, RJ45/HDMI - \$210, HDMI/USB - \$205

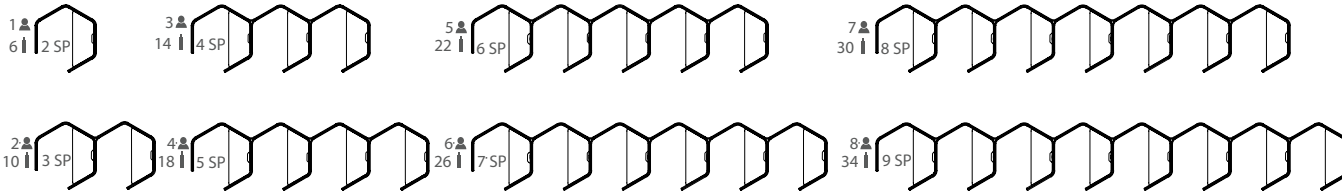

Number of Feet per Typical (MTL10 Option) "SP" Number of Starter Panels per Typical (RSP Option)

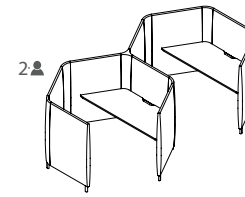

1 Select Model

w" x d" x h"	Weight	Standard Veneer Top Upholstered Panels - COM\$	Premium Veneer Top Upholstered Panels - COM\$
602 x 86 x 55	128	8 HNY60286FT576W 60482	"P" Option N/A
528 x 86 x 55	112	7 HNY52886FT576W 53098	"P" Option N/A
453 x 86 x 55	97	6 HNY45386FT576W 45714	"P" Option N/A
378 x 86 x 55	81	5 HNY37886FT576W 38330	"P" Option N/A
303 x 86 x 55	66	4 HNY30386FT576W 30946	"P" Option N/A
228 x 86 x 55	50	3 HNY22886FT576W 23562	"P" Option N/A
153 x 86 x 55	35	2 HNY15386FT576W 16178	"P" Option N/A
78 x 86 x 55	19	1 HNY7886FT576W 8794	"P" Option N/A

[Click Here for Graded in Pricing](#)

2 Select Finish

Click to view finishes

WWP	WOW
PO01	WNO
PO02	WSO
PO03	WNF(Natural Oak on Flat Cut)
PO08	WSF(Salted Oak on Flat Cut)
PO09	
WBW	
WSW	
WEC	

3 Select Feet Finish

Click to view edges

WWP	WOW
PO01	WNO
PO02	WSO
PO03	
PO07	
PO08	
PO09	
WBW	
WSW	
WEC	

4 Select Edge

Click to view details

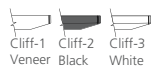

High Pressure Laminate Top Upholstered Panels - COM\$

HNY60286FT576G 58882	"P" Option N/A
HNY52886FT576G 51698	"P" Option N/A
HNY45386FT576G 44514	"P" Option N/A
HNY37886FT576G 37330	"P" Option N/A
HNY30386FT576G 30146	"P" Option N/A
HNY22886FT576G 22962	"P" Option N/A
HNY15386FT576G 15778	"P" Option N/A
HNY7886FT576G 8594	"P" Option N/A

GEC	LW04
GNA +5%	LW05
GWL	LW06
LP01	
LF02	
LF03	
LN01	
LA02	
LW01	
LW02	

WWP	WOW
PO01	WNO
PO02	WSO
PO03	
PO07	
PO08	
PO09	
WBW	
WSW	
WEC	



Thermally Fused Laminate Top Upholstered Panels - COM\$

HNY60286FT576M 55826	"P" Option N/A
HNY52886FT576M 49024	"P" Option N/A
HNY45386FT576M 42222	"P" Option N/A
HNY37886FT576M 35420	"P" Option N/A
HNY30386FT576M 28618	"P" Option N/A
HNY22886FT576M 21816	"P" Option N/A
HNY15386FT576M 15014	"P" Option N/A
HNY7886FT576M 8212	"P" Option N/A

MOC
MEC
MSW
MTW
MWL
MNA

WWP	WOW
PO01	WNO
PO02	WSO
PO03	
PO07	
PO08	
PO09	
WBW	
WSW	



[Click here to view statement of line](#)

Product Features

- 5" Solid wood feet - oval shape
- HNY7226WT162 Fixed Desk Height worksurfaces, 29" worksurface height
- Ships KD
- T75 worksurface wire cutout is standard on all worksurfaces.(T75D: Delete cutout is optional)

Options

Accessories

- K28: Articulating Keyboard w/ Mouse - \$390
- K31-SK: Center drawer w/ skirt - \$310
- K31: Center drawer w/o skirt - \$205

Concealed Floor Power Infeed Cover

- PCEB: White Metal Finish concealed floor power infeed cover - \$150

Delete Top

- DFT: Delete fixed top. Deduct \$1325 Veneer(W), \$1125 High Pressure Laminate (G), \$743 Thermally Fused Laminate (M) per top

Metal Feet

- MTL10: Replace solid wood feet with metal feet, standard MFW White - \$55 ea

Premium Metal Finish

- Specify premium Metal Finish. MFMB: Matte Black, MFS: Silver, MFSS: Salmon Sienna, MFSA: Surfing Aquavert, MFPS: Pistachio, MFOS: Oyster, MFNA: Navy, MFOL: Olive, MFGB: Grey Beige MFGG: Graphite Gray, MFG: Gray, MFGM:Matte Gold
- Premium Metal Finish for WMT Wire Management Tray - \$75 ea
- Premium Metal Finish for MTL10 Metal Feet - \$20 ea
- Premium Metal Finish for PCEB Concealed Floor Power Infeed Cover - \$35

Starter Panel

- RSP: Substitute round starter panel in place of flat starter panel. Must substitute all starters, priced per starter panel - \$83 each. See HNY3555SP888

Worksurface Height

- Modify worksurface height to bar height.
- THL-42: Position worksurface at bar height - N/C

Wire Tray

- WMT: Wire metal tray. Mounts under top and comes standard in MFW White - \$210

# DARRAN<sup>®</sup>

# Honey

## Inline Hexagon Workstation Typical Position 1 Desk with Power Fixed Worksurface

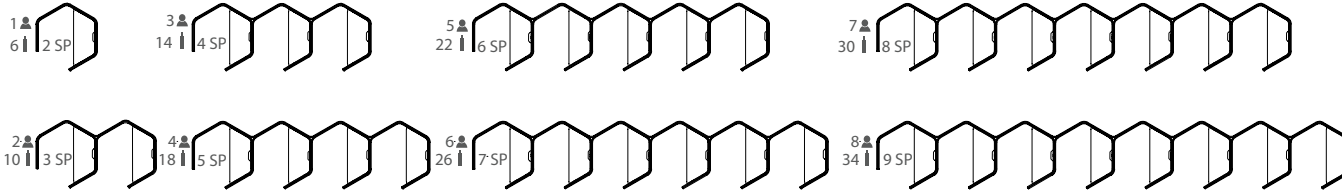

↓ Number of Feet per Typical (MTL10 Option) "SP" Number of Starter Panels per Typical (RSP Option)

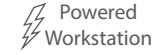
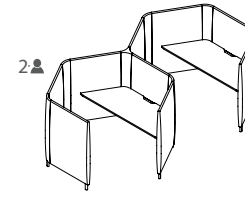

### 1 Select Model

w" x d" x h"	Weight	Standard Veneer Top Upholstered Panels - COM\$	Premium Veneer Top Upholstered Panels - COM\$	High Pressure Laminate Top Upholstered Panels - COM\$	Thermally Fused Laminate Top Upholstered Panels - COM\$
602 x 86 x 55	128	8 HNY60286FP576W 65382	"P" Option N/A	HNY60286FP576G 63782	HNY60286FP576M 60726
528 x 86 x 55	112	7 HNY52886FP576W 57393	"P" Option N/A	HNY52886FP576G 55993	HNY52886FP576M 53319
453 x 86 x 55	97	6 HNY45386FP576W 49404	"P" Option N/A	HNY45386FP576G 48204	HNY45386FP576M 45912
378 x 86 x 55	81	5 HNY37886FP576W 41415	"P" Option N/A	HNY37886FP576G 40415	HNY37886FP576M 38505
303 x 86 x 55	66	4 HNY30386FP576W 33426	"P" Option N/A	HNY30386FP576G 32626	HNY30386FP576M 31098
228 x 86 x 55	50	3 HNY22886FP576W 25437	"P" Option N/A	HNY22886FP576G 24837	HNY22886FP576M 23691
153 x 86 x 55	35	2 HNY15386FP576W 17448	"P" Option N/A	HNY15386FP576G 17048	HNY15386FP576M 16284
78 x 86 x 55	19	1 HNY7886FP576W 9459	"P" Option N/A	HNY7886FP576G 9259	HNY7886FP576M 8877

[Click Here for Graded in Pricing](#)

### 2 Select Finish

Click to view finishes

WWP	WOW
PO01	WNO
PO02	WSO
PO03	WNF(Natural Oak on Flat Cut)
PO07	WSF(Salted Oak on Flat Cut)
PO08	WSF(Salted Oak on Flat Cut)
PO09	WSF(Salted Oak on Flat Cut)
WBW	
WSW	
WEC	

### 3 Select Feet Finish

Click to view edges

WWP	WOW
PO01	WNO
PO02	WSO
PO03	
PO07	
PO08	
PO09	
WBW	
WSW	
WEC	

### 4 Select Edge

Click to view details



GEC	LW04
GNA +5%	LW05
GWL	LW06
LP01	
LF02	
LF03	
LN01	
LA02	
LW01	
LW02	

WWP	WOW
PO01	WNO
PO02	WSO
PO03	
PO07	
PO08	
PO09	
WBW	
WSW	
WEC	



MOC
MEC
MSW
MTW
MWL
MNA

WWP	WOW
PO01	WNO
PO02	WSO
PO03	
PO07	
PO08	
PO09	
WEC	
WBW	
WSW	



[Click here to view statement of line](#)

### Product Features

- HNY7226WT162 Fixed Desk Height worksurfaces, 29" worksurface height
- 5" Solid wood feet - oval shape
- 4 Power outlets with 1 telecom plate, see options below for telecom plate
- Ships KD
- Wire management tray attaches to worksurface top, standard in MFW White, see premium Metal Finish for options
- Hardwire infeed and jumpers are included in workstations
- T75 worksurface wire cutout is standard on all worksurfaces.(T75D: Delete cutout is optional)

### Options

#### Accessories

- K28: Articulating Keyboard w/ Mouse - \$390
- K31-SK: Center drawer w/ skirt - \$310
- K31: Center drawer w/o skirt - \$205

#### Concealed Floor Power Infeed Cover

- PCEB: White Metal Finish concealed floor power infeed cover - \$150

#### Delete Top and Wire Tray

- DFP: Delete fixed top. Deduct \$1535 Veneer (W), \$1335 High Pressure Laminate (G), \$953 Thermally Fused Laminate (M) per top

#### Metal Feet

- MTL10: Replace solid wood feet with metal feet, standard MFW White - \$55 ea

#### Premium Metal Finish

- Specify premium Metal Finish. MFMB: Matte Black, MFS: Silver, MFSS: Salmon Sienna, MFSA: Surfing Aquavert, MFPS: Pistachio, MFOS: Oyster, MFNA: Navy, MFOL: Olive, MFGB: Grey Beige MFGG: Graphite Gray, MFG: Gray, MFGM:Matte Gold
- Premium Metal Finish for WMT Wire Management Tray - \$75 ea
- Premium Metal Finish for MTL10 Metal Feet - \$20 ea
- Premium Metal Finish for PCEB Concealed Floor Power Infeed Cover - \$35

#### Starter Panel

- RSP: Substitute round starter panel in place of flat starter panel. Must substitute all starters, priced per starter panel - \$83 each. See HNY3555SP888

#### Telecom Plates

- Each power unit has 1 plate. All telecom connectors sold separately.
- RJ45 (1) - \$55, RJ45 (2) - \$110, RJ45 (3) - \$165, USB (1) - \$70, USB (2) - \$140, RJ45/USB - \$125, RJ45/HDMI - \$210, HDMI/USB - \$205

#### Worksurface Height

- THL-42: Modify worksurface height to bar height - N/C

**DARRAN**

**Honey**

Inline Hexagon Workstation Typical  
Position 2 Desk with Height Adjustable Worksurface

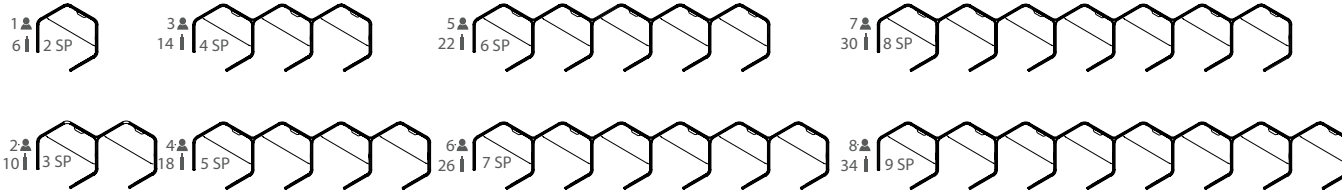

Number of Feet per Typical (MTL10 Option) "SP" Number of Starter Panels per Typical (RSP Option)

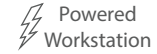
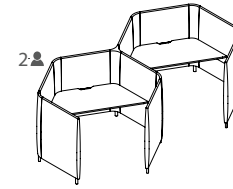

**1 Select Model**

w" x d" x h"	Weight	Standard Veneer Top Upholstered Panels - COM\$	Premium Veneer Top Upholstered Panels - COM\$	High Pressure Laminate Top Upholstered Panels - COM\$	Thermally Fused Laminate Top Upholstered Panels - COM\$
602 x 86 x 55	128	8 HNY60286HA577W 83185	"P" Option N/A	HNY60286HA577G 81577	HNY60286HA577M 78521
528 x 86 x 55	112	7 HNY52886HA577W 72980	"P" Option N/A	HNY52886HA577G 71573	HNY52886HA577M 68899
453 x 86 x 55	97	6 HNY45386HA577W 62775	"P" Option N/A	HNY45386HA577G 61569	HNY45386HA577M 59277
378 x 86 x 55	81	5 HNY37886HA577W 52570	"P" Option N/A	HNY37886HA577G 51565	HNY37886HA577M 49655
303 x 86 x 55	66	4 HNY30386HA577W 42365	"P" Option N/A	HNY30386HA577G 41561	HNY30386HA577M 40033
228 x 86 x 55	50	3 HNY22886HA577W 32160	"P" Option N/A	HNY22886HA577G 31557	HNY22886HA577M 30411
153 x 86 x 55	35	2 HNY15386HA577W 21955	"P" Option N/A	HNY15386HA577G 21553	HNY15386HA577M 20789
78 x 86 x 55	19	1 HNY7886HA577W 11750	"P" Option N/A	HNY7886HA577G 11549	HNY7886HA577M 11167

[Click Here for Graded in Pricing](#)

**2 Select Finish**

Click to view finishes

WWP	WOW
PO01	WNO
PO02	WSO
PO03	WNF(Natural Oak on Flat Cut)
PO07	WSF(Salted Oak on Flat Cut)
PO08	WSF(Salted Oak on Flat Cut)
PO09	WSF(Salted Oak on Flat Cut)
WBW	
WSW	
WEC	

**3 Select Feet Finish**

Click to view edges

WWP	WOW
PO01	WNO
PO02	WSO
PO03	
PO07	
PO08	
PO09	
WBW	
WSW	
WEC	

**4 Select Edge**

Click to view details

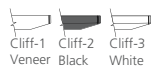

[Click here to view statement of line](#)

**Product Features**

- 5" Solid wood feet - oval shape, ships KD
- 4 Power outlets with 1 telecom plate, see options below for telecom plate
- Adjustable height from 27" to 47.5" with a maximum weight capacity of 275 lbs.
- Lift standard in MFW White, optional MFB Black
- HNY7125WT163 Height Adjustable worksurfaces are included
- Wire management tray attaches to worksurface top, standard in MFW White, see premium Metal Finish for options
- T75 worksurface wire cutout is standard on all worksurfaces.(T75D: Delete cutout is optional)

**Notes**

- 1" Gap between worksurface and panels to drop wires below worksurface
- Metal parts include 5 year warranty
- Programmable height adjustable mechanism, motor includes 2 year warranty

**Options**

**Accessories**

- K28: Articulating Keyboard w/ Mouse - \$390
- K31-SK: Center drawer w/ skirt - \$310
- K31: Center drawer w/o skirt - \$205

**Concealed Floor Power Infeed Cover**

- PCEB: White Metal Finish concealed floor power infeed cover - \$150

**Delete Top and Wire Tray**

- DHAT: Delete height adjustable top. Deduct \$3845 Veneer(W), \$3644 High Pressure Laminate(G), \$3262 Thermally Fused Laminate(M) per top

**Metal Feet**

- MTL10: Replace solid wood feet with metal feet, standard MFW White - \$55 ea

**Premium Metal Finish**

- Specify premium Metal Finish. MFMB: Matte Black, MFS: Silver, MFSS: Salmon Sienna, MFSA: Surfing Aquavert, MFPS: Pistachio, MFOS: Oyster, MFNA: Navy, MFOL: Olive, MFGB: Grey Beige MFGG: Graphite Gray, MFG: Gray, MFGM:Matte Gold
- Premium Metal Finish for WMT Wire Management Tray - \$75 ea
- Premium Metal Finish for MTL10 Metal Feet - \$20 ea
- Premium Metal Finish for PCEB Concealed Floor Power Infeed Cover - \$35

**Starter Panel**

- RSP: Substitute round starter panel in place of flat starter panel. Must substitute all starters, priced per starter panel - \$83 each. See HNY3555SP888

**Telecom Plates**

- Each power unit has 1 plate. All telecom connectors sold separately.
- RJ45 (1) - \$55, RJ45 (2) - \$110, RJ45 (3) - \$165, USB (1) - \$70, USB (2) - \$140, RJ45/USB - \$125, RJ45/HDMI - \$210, HDMI/USB - \$205

# DARRAN<sup>®</sup>

# Honey

## Inline Hexagon Workstation Typical Position 2 Desk with Fixed Worksurface

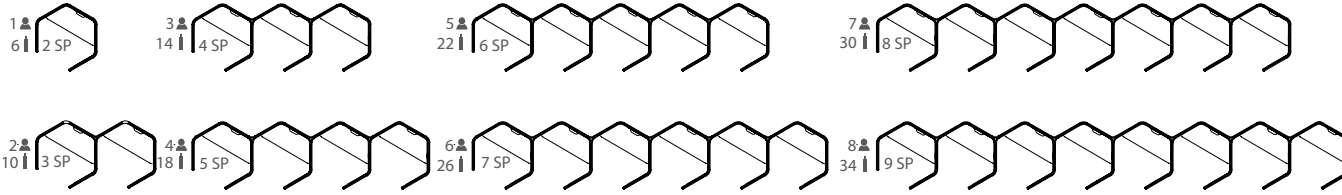

Number of Feet per Typical (MTL10 Option) "SP" Number of Starter Panels per Typical (RSP Option)

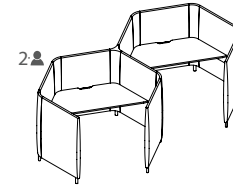

Fixed Top Workstation

Non-Powered Workstation

### 1 Select Model

w" x d" x h"	Weight	Standard Veneer Top Upholstered Panels - COM\$	Premium Veneer Top Upholstered Panels - COM\$
602 x 86 x 55	128	8 HNY60286FT577W 60482	"P" Option N/A
528 x 86 x 55	112	7 HNY52886FT577W 53098	"P" Option N/A
453 x 86 x 55	97	6 HNY45386FT577W 45714	"P" Option N/A
378 x 86 x 55	81	5 HNY37886FT577W 38330	"P" Option N/A
303 x 86 x 55	66	4 HNY30386FT577W 30946	"P" Option N/A
228 x 86 x 55	50	3 HNY22886FT577W 23562	"P" Option N/A
153 x 86 x 55	35	2 HNY15386FT577W 16178	"P" Option N/A
78 x 86 x 55	19	1 HNY7886FT577W 8794	"P" Option N/A

[Click Here for Graded in Pricing](#)

### 2 Select Finish

Click to view finishes

WWP	WOW
PO01	WNO
PO02	WSO
PO03	WNF(Natural Oak on Flat Cut)
PO07	WSF(Salted Oak on Flat Cut)
PO08	WSF(Salted Oak on Flat Cut)
PO09	WSF(Salted Oak on Flat Cut)
WBW	
WSW	
WEC	

### 3 Select Feet Finish

Click to view edges

WWP	WOW
PO01	WNO
PO02	WSO
PO03	
PO07	
PO08	
PO09	
WBW	
WSW	
WEC	

### 4 Select Edge

Click to view details

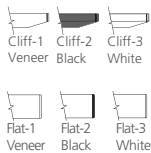

### High Pressure Laminate Top Upholstered Panels - COM\$

HNY60286FT577G 58882	"P" Option N/A
HNY52886FT577G 51698	"P" Option N/A
HNY45386FT577G 44514	"P" Option N/A
HNY37886FT577G 37330	"P" Option N/A
HNY30386FT577G 30146	"P" Option N/A
HNY22886FT577G 22962	"P" Option N/A
HNY15386FT577G 15778	"P" Option N/A
HNY7886FT577G 8594	"P" Option N/A

GEC	LW04
GNA +5%	LW05
GWL	LW06
LP01	
LF02	
LF03	
LN01	
LA02	
LW01	
LW02	

WWP	WOW
PO01	WNO
PO02	WSO
PO03	
PO07	
PO08	
PO09	
WBW	
WSW	
WEC	

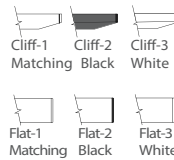

### Thermally Fused Laminate Top Upholstered Panels - COM\$

HNY60286FT577M 55826	"P" Option N/A
HNY52886FT577M 49024	"P" Option N/A
HNY45386FT577M 42222	"P" Option N/A
HNY37886FT577M 35420	"P" Option N/A
HNY30386FT577M 28618	"P" Option N/A
HNY22886FT577M 21816	"P" Option N/A
HNY15386FT577M 15014	"P" Option N/A
HNY7886FT577M 8212	"P" Option N/A

MOC
MEC
MSW
MTW
MWL
MNA

WWP	WOW
PO01	WNO
PO02	WSO
PO03	
PO07	
PO08	
PO09	
WBW	
WSW	



[Click here to view statement of line](#)

### Product Features

- 5" Solid wood feet - oval shape
- HNY7226WT162 Fixed Desk Height worksurfaces, 29" worksurface height
- Ships KD
- T75 worksurface wire cutout is standard on all worksurfaces.(T75D: Delete cutout is optional)

### Options

#### Accessories

- K28: Articulating Keyboard w/ Mouse - \$390
- K31-SK: Center drawer w/ skirt - \$310
- K31: Center drawer w/o skirt - \$205

#### Concealed Floor Power Infeed Cover

- PCEB: White Metal Finish concealed floor power infeed cover - \$150

#### Delete Top

- DFT: Delete fixed top. Deduct \$1325 Veneer(W), \$1125 High Pressure Laminate (G), \$743 Thermally Fused Laminate (M) per top

#### Metal Feet

- MTL10: Replace solid wood feet with metal feet, standard MFW White - \$55 ea

#### Premium Metal Finish

- Specify premium Metal Finish. MFMB: Matte Black, MFS: Silver, MFSS: Salmon Sienna, MFSA: Surfing Aquavert, MFPS: Pistachio, MFOS: Oyster, MFNA: Navy, MFOL: Olive, MFGB: Grey Beige MFGG: Graphite Gray, MFG: Gray, MFGM:Matte Gold
- Premium Metal Finish for WMT Wire Management Tray - \$75 ea
- Premium Metal Finish for MTL10 Metal Feet - \$20 ea
- Premium Metal Finish for PCEB Concealed Floor Power Infeed Cover - \$35

#### Starter Panel

- RSP: Substitute round starter panel in place of flat starter panel. Must substitute all starters, priced per starter panel - \$83 each. See HNY3555SP888

#### Worksurface Height

- Modify worksurface height to bar height.
- THL-42: Position worksurface at bar height - N/C

#### Wire Tray

- WMT: Wire metal tray. Mounts under top and comes standard in MFW White - \$210



**DARRAN**

**Honey**

Inline Hexagon Workstation Typical  
Position 2 Desk with Power Fixed Worksurface

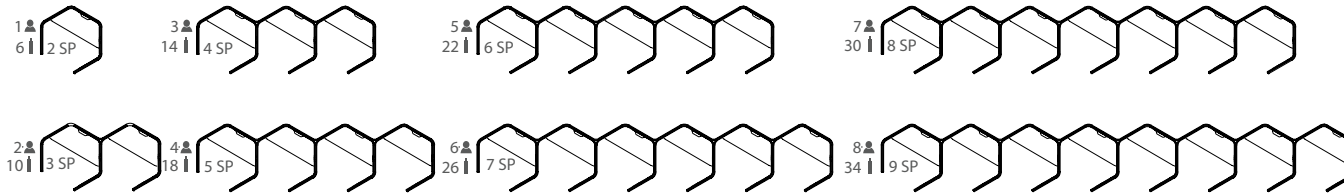

Number of Feet per Typical (MTL10 Option) "SP" Number of Starter Panels per Typical (RSP Option)

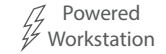
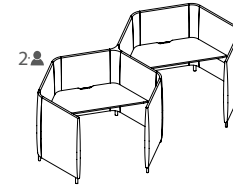

**1 Select Model**

w" x d" x h"	Weight	Standard Veneer Top Upholstered Panels - COM\$	Premium Veneer Top Upholstered Panels - COM\$	High Pressure Laminate Top Upholstered Panels - COM\$	Thermally Fused Laminate Top Upholstered Panels - COM\$
602 x 86 x 55	128	8 HNY60286FP577W 64857	"P" Option N/A	HNY60286FP577G 63257	HNY60286FP577M 60201
528 x 86 x 55	112	7 HNY52886FP577W 56943	"P" Option N/A	HNY52886FP577G 55543	HNY52886FP577M 52869
453 x 86 x 55	97	6 HNY45386FP577W 49029	"P" Option N/A	HNY45386FP577G 47829	HNY45386FP577M 45537
378 x 86 x 55	81	5 HNY37886FP577W 41115	"P" Option N/A	HNY37886FP577G 40115	HNY37886FP577M 38205
303 x 86 x 55	66	4 HNY30386FP577W 33201	"P" Option N/A	HNY30386FP577G 32401	HNY30386FP577M 30873
228 x 86 x 55	50	3 HNY22886FP577W 25287	"P" Option N/A	HNY22886FP577G 24687	HNY22886FP577M 23541
153 x 86 x 55	35	2 HNY15386FP577W 17373	"P" Option N/A	HNY15386FP577G 16973	HNY15386FP577M 16209
78 x 86 x 55	19	1 HNY7886FP577W 9459	"P" Option N/A	HNY7886FP577G 9259	HNY7886FP577M 8877

[Click Here for Graded in Pricing](#)

**2 Select Finish**

Click to view finishes

WWP	WOW
PO01	WNO
PO02	WSO
PO03	WNF(Natural Oak on Flat Cut)
PO07	WSF(Salted Oak on Flat Cut)
PO08	WSF(Salted Oak on Flat Cut)
PO09	WSF(Salted Oak on Flat Cut)
WBW	
WSW	
WEC	

**3 Select Feet Finish**

Click to view edges

WWP	WOW
PO01	WNO
PO02	WSO
PO03	
PO07	
PO08	
PO09	
WBW	
WSW	
WEC	

**4 Select Edge**

Click to view details

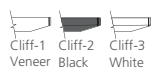

GEC	LW04
GNA +5%	LW05
GWL	LW06
LP01	
LF02	
LF03	
LN01	
LA02	
LW01	
LW02	

WWP	WOW
PO01	WNO
PO02	WSO
PO03	
PO07	
PO08	
PO09	
WBW	
WSW	
WEC	



MOC
MEC
MSW
MTW
MWL
MNA

WWP	WOW
PO01	WNO
PO02	WSO
PO03	
PO07	
PO08	
PO09	
WEC	
WBW	
WSW	



[Click here to view statement of line](#)

**Product Features**

- HNY7226WT162 Fixed Desk Height worksurfaces, 29" worksurface height
- 5" Solid wood feet - oval shape
- 4 Power outlets with 1 telecom plate, see options below for telecom plate
- Ships KD
- Wire management tray attaches to worksurface top, standard in MFW White, see premium Metal Finish for options
- Hardwire infeed and jumpers are included in workstations
- T75 worksurface wire cutout is standard on all worksurfaces.(T75D: Delete cutout is optional)

**Options**

**Accessories**

- K28: Articulating Keyboard w/ Mouse - \$390
- K31-SK: Center drawer w/ skirt - \$310
- K31: Center drawer w/o skirt - \$205

**Concealed Floor Power Infeed Cover**

- PCEB: White Metal Finish concealed floor power infeed cover - \$150

**Delete Top and Wire Tray**

- DFP: Delete fixed top. Deduct \$1535 Veneer (W), \$1335 High Pressure Laminate (G), \$953 Thermally Fused Laminate (M) per top

**Metal Feet**

- MTL10: Replace solid wood feet with metal feet, standard MFW White - \$55 ea

**Premium Metal Finish**

- Specify premium Metal Finish. MFMB: Matte Black, MFS: Silver, MFSS: Salmon Sienna, MFSA: Surfing Aquavert, MFPS: Pistachio, MFOS: Oyster, MFNA: Navy, MFOL: Olive, MFGB: Grey Beige MFGG: Graphite Gray, MFG: Gray, MFGM:Matte Gold
- Premium Metal Finish for WMT Wire Management Tray - \$75 ea
- Premium Metal Finish for MTL10 Metal Feet - \$20 ea
- Premium Metal Finish for PCEB Concealed Floor Power Infeed Cover - \$35

**Starter Panel**

- RSP: Substitute round starter panel in place of flat starter panel. Must substitute all starters, priced per starter panel - \$83 each. See HNY3555SP888

**Telecom Plates**

- Each power unit has 1 plate. All telecom connectors sold separately.
- RJ45 (1) - \$55, RJ45 (2) - \$110, RJ45 (3) - \$165, USB (1) - \$70, USB (2) - \$140, RJ45/USB - \$125, RJ45/HDMI - \$210, HDMI/USB - \$205

**Worksurface Height**

- THL-42: Modify worksurface height to bar height - N/C

# DARRAN

# Honey

## Inline Hexagon Workstation Typical Position 3 with Height Adjustable Worksurface

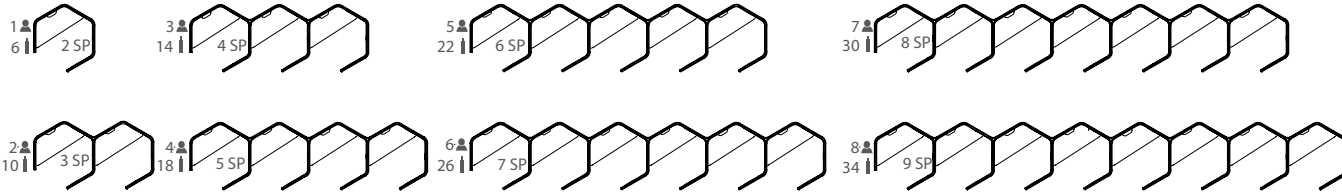

Number of Feet per Typical (MTL10 Option) "SP" Number of Starter Panels per Typical (RSP Option)

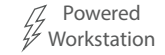
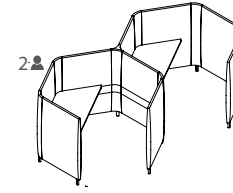

### 1 Select Model

w" x d" x h"	Weight	Standard Veneer Top Upholstered Panels - COM\$	Premium Veneer Top Upholstered Panels - COM\$
602 x 86 x 55	128	8 HNY60286HA578W 83185	"P" Option N/A
528 x 86 x 55	112	7 HNY52886HA578W 72980	"P" Option N/A
453 x 86 x 55	97	6 HNY45386HA578W 62775	"P" Option N/A
378 x 86 x 55	81	5 HNY37886HA578W 52570	"P" Option N/A
303 x 86 x 55	66	4 HNY30386HA578W 42365	"P" Option N/A
228 x 86 x 55	50	3 HNY22886HA578W 32160	"P" Option N/A
153 x 86 x 55	35	2 HNY15386HA578W 21955	"P" Option N/A
78 x 86 x 55	19	1 HNY7886HA578W 11750	"P" Option N/A

[Click Here for Graded in Pricing](#)

### 2 Select Finish

Click to view finishes

WWP	WOW
PO01	WNO
PO02	WSO
PO03	WNF(Natural Oak on Flat Cut)
PO07	WSF(Salted Oak on Flat Cut)
PO08	WSF(Salted Oak on Flat Cut)
PO09	WSF(Salted Oak on Flat Cut)
WBW	
WSW	
WEC	

### 3 Select Feet Finish

Click to view edges

WWP	WOW
PO01	WNO
PO02	WSO
PO03	
PO07	
PO08	
PO09	
WBW	
WSW	
WEC	

### 4 Select Edge

Click to view details



### High Pressure Laminate Top Upholstered Panels - COM\$

HNY60286HA578G	81577
HNY52886HA578G	71573
HNY45386HA578G	61569
HNY37886HA578G	51565
HNY30386HA578G	41561
HNY22886HA578G	31557
HNY15386HA578G	21553
HNY7886HA578G	11549

GEC	LW04
GNA +5%	LW05
GWL	LW06
LP01	
LF02	
LF03	
LN01	
LA02	
LW01	
LW02	

WWP	WOW
PO01	WNO
PO02	WSO
PO03	
PO07	
PO08	
PO09	
WBW	
WSW	
WEC	



### Thermally Fused Laminate Top Upholstered Panels - COM\$

HNY60286HA578M	78521
HNY52886HA578M	68899
HNY45386HA578M	59277
HNY37886HA578M	49655
HNY30386HA578M	40033
HNY22886HA578M	30411
HNY15386HA578M	20789
HNY7886HA578M	11167

MOC
MEC
MSW
MTW
MWL
MNA

WWP	WOW
PO01	WNO
PO02	WSO
PO03	
PO07	
PO08	
PO09	
WBW	
WSW	



[Click here to view statement of line](#)

### Product Features

- 5" Solid wood feet - oval shape, ships KD
- 4 Power outlets with 1 telecom plate, see options below for telecom plate
- Adjustable height from 27" to 47.5" with a maximum weight capacity of 275 lbs.
- Lift standard in MFW White, optional MFB Black
- HNY7125WT163 Height Adjustable worksurfaces are included
- Wire management tray attaches to worksurface top, standard in MFW White, see premium Metal Finish for options
- T75 worksurface wire cutout is standard on all worksurfaces.(T75D: Delete cutout is optional)

### Notes

- 1" Gap between worksurface and panels to drop wires below worksurface
- Metal parts include 5 year warranty
- Programmable height adjustable mechanism, motor includes 2 year warranty

### Options

#### Accessories

- K28: Articulating Keyboard w/ Mouse - \$390
- K31-SK: Center drawer w/ skirt - \$310
- K31: Center drawer w/o skirt - \$205

#### Concealed Floor Power Infeed Cover

- PCEB: White Metal Finish concealed floor power infeed cover - \$150

#### Delete Top and Wire Tray

- DHAT: Delete height adjustable top. Deduct \$3845 Veneer(W), \$3644 High Pressure Laminate(G), \$3262 Thermally Fused Laminate(M) per top

#### Metal Feet

- MTL10: Replace solid wood feet with metal feet, standard MFW White - \$55 ea

#### Premium Metal Finish

- Specify premium Metal Finish. MFMB: Matte Black, MFS: Silver, MFSS: Salmon Sienna, MFSA: Surfin Aquavert, MFPS: Pistachio, MFOS: Oyster, MFNA: Navy, MFOL: Olive, MFGB: Grey Beige MFGG: Graphite Gray, MFG: Gray, MFGM:Matte Gold
- Premium Metal Finish for WMT Wire Management Tray - \$75 ea
- Premium Metal Finish for MTL10 Metal Feet - \$20 ea
- Premium Metal Finish for PCEB Concealed Floor Power Infeed Cover - \$35

#### Starter Panel

- RSP: Substitute round starter panel in place of flat starter panel. Must substitute all starters, priced per starter panel - \$83 each. See HNY3555SP888

#### Telecom Plates

- Each power unit has 1 plate. All telecom connectors sold separately.
- RJ45 (1) - \$55, RJ45 (2) - \$110, RJ45 (3) - \$165, USB (1) - \$70, USB (2) - \$140, RJ45/USB - \$125, RJ45/HDMI - \$210, HDMI/USB - \$205

**DARRAN**

**Honey**

Inline Hexagon Workstation Typical  
Position 3 Desk with Fixed Worksurface

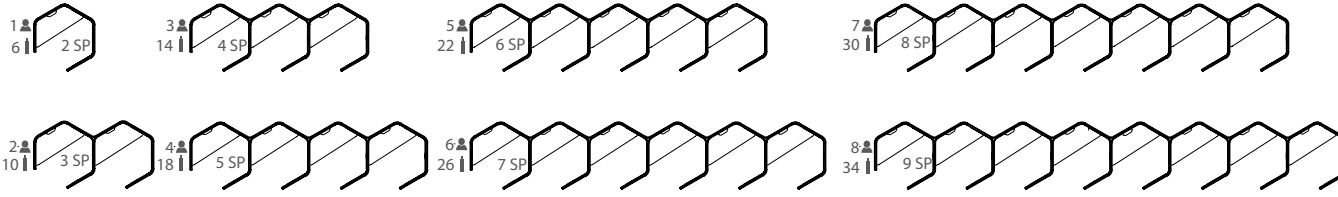

Number of Feet per Typical (MTL10 Option) "SP" Number of Starter Panels per Typical (RSP Option)

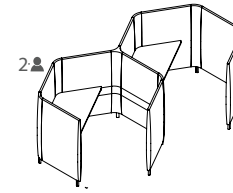

**1 Select Model**

w" x d" x h"	Weight	Standard Veneer Top Upholstered Panels - COM\$	Premium Veneer Top Upholstered Panels - COM\$
602 x 86 x 55	128	8 HNY60286FT578W 60482	"P" Option N/A
528 x 86 x 55	112	7 HNY52886FT578W 53098	"P" Option N/A
453 x 86 x 55	97	6 HNY45386FT578W 45714	"P" Option N/A
378 x 86 x 55	81	5 HNY37886FT578W 38330	"P" Option N/A
303 x 86 x 55	66	4 HNY30386FT578W 30946	"P" Option N/A
228 x 86 x 55	50	3 HNY22886FT578W 23562	"P" Option N/A
153 x 86 x 55	35	2 HNY15386FT578W 16178	"P" Option N/A
78 x 86 x 55	19	1 HNY7886FT578W 8794	"P" Option N/A

[Click Here for Graded in Pricing](#)

**2 Select Finish**

Click to view finishes

WWP	WOW
PO01	WNO
PO02	WSO
PO03	WNF(Natural Oak on Flat Cut)
PO07	WSF(Salted Oak on Flat Cut)
PO08	WSF(Salted Oak on Flat Cut)
PO09	WSF(Salted Oak on Flat Cut)
WBW	
WSW	
WEC	

**3 Select Feet Finish**

Click to view edges

WWP	WOW
PO01	WNO
PO02	WSO
PO03	
PO07	
PO08	
PO09	
WBW	
WSW	
WEC	

**4 Select Edge**

Click to view details

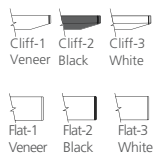

High Pressure Laminate Top Upholstered Panels - COM\$

HNY60286FT578G	58882
HNY52886FT578G	51698
HNY45386FT578G	44514
HNY37886FT578G	37330
HNY30386FT578G	30146
HNY22886FT578G	22962
HNY15386FT578G	15778
HNY7886FT578G	8594

GEC	LW04
GNA +5%	LW05
GWL	LW06
LP01	
LF02	
LF03	
LN01	
LA02	
LW01	
LW02	

WWP	WOW
PO01	WNO
PO02	WSO
PO03	
PO07	
PO08	
PO09	
WBW	
WSW	
WEC	

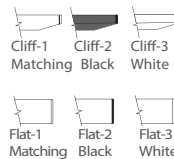

Thermally Fused Laminate Top Upholstered Panels - COM\$

HNY60286FT578M	55826
HNY52886FT578M	49024
HNY45386FT578M	42222
HNY37886FT578M	35420
HNY30386FT578M	28618
HNY22886FT578M	21816
HNY15386FT578M	15014
HNY7886FT578M	8212

MOC
MEC
MSW
MTW
MWL
MNA

WWP	WOW
PO01	WNO
PO02	WSO
PO03	
PO07	
PO08	
PO09	
WBW	
WSW	



[Click here to view statement of line](#)

**Product Features**

- 5" Solid wood feet - oval shape
- HNY7226WT162 Fixed Desk Height worksurfaces, 29" worksurface height
- Ships KD
- T75 worksurface wire cutout is standard on all worksurfaces.(T75D: Delete cutout is optional)

**Options**

**Accessories**

- K28: Articulating Keyboard w/ Mouse - \$390
- K31-SK: Center drawer w/ skirt - \$310
- K31: Center drawer w/o skirt - \$205

**Concealed Floor Power Infeed Cover**

- PCEB: White Metal Finish concealed floor power infeed cover - \$150

**Delete Top**

- DFT: Delete fixed top. Deduct \$1325 Veneer(W), \$1125 High Pressure Laminate (G), \$743 Thermally Fused Laminate (M) per top

**Metal Feet**

- MTL10: Replace solid wood feet with metal feet, standard MFW White - \$55 ea

**Premium Metal Finish**

- Specify premium Metal Finish. MFMB: Matte Black, MFS: Silver, MFSS: Salmon Sienna, MFSA: Surfing Aquavert, MFPS: Pistachio, MFOS: Oyster, MFNA: Navy, MFOL: Olive, MFGB: Grey Beige MFGG: Graphite Gray, MFG: Gray, MFGM:Matte Gold
- Premium Metal Finish for WMT Wire Management Tray - \$75 ea
- Premium Metal Finish for MTL10 Metal Feet - \$20 ea
- Premium Metal Finish for PCEB Concealed Floor Power Infeed Cover - \$35

**Starter Panel**

- RSP: Substitute round starter panel in place of flat starter panel. Must substitute all starters, priced per starter panel - \$83 each. See HNY3555SP888

**Worksurface Height**

- Modify worksurface height to bar height.
- THL-42: Position worksurface at bar height - N/C

**Wire Tray**

- WMT: Wire metal tray. Mounts under top and comes standard in MFW White - \$210

**DARRAN**

**Honey**

Inline Hexagon Workstation Typical  
Position 3 Desk with Power Fixed Worksurface

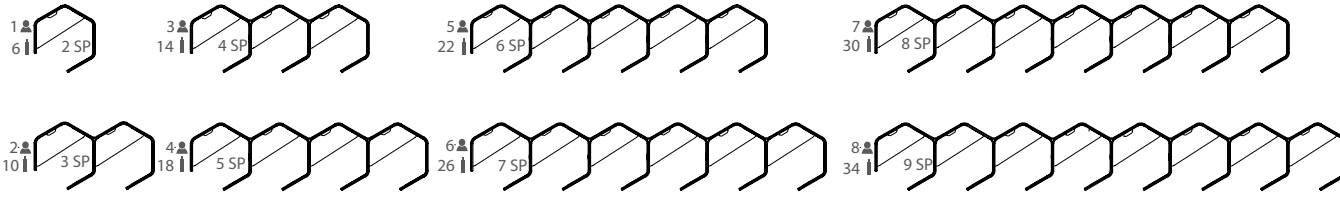

Number of Feet per Typical (MTL10 Option) "SP" Number of Starter Panels per Typical (RSP Option)

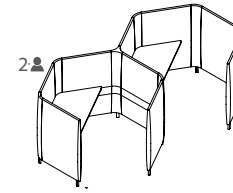

Fixed Top Workstation

Powered Workstation

**1 Select Model**

w" x d" x h"	Weight	Standard Veneer Top Upholstered Panels - COM\$	Premium Veneer Top Upholstered Panels - COM\$
602 x 86 x 55	128	8 HNY60286FP578W 64857	"P" Option N/A
528 x 86 x 55	112	7 HNY52886FP578W 56943	"P" Option N/A
453 x 86 x 55	97	6 HNY45386FP578W 49029	"P" Option N/A
378 x 86 x 55	81	5 HNY37886FP578W 41115	"P" Option N/A
303 x 86 x 55	66	4 HNY30386FP578W 33201	"P" Option N/A
228 x 86 x 55	50	3 HNY22886FP578W 25287	"P" Option N/A
153 x 86 x 55	35	2 HNY15386FP578W 17373	"P" Option N/A
78 x 86 x 55	19	1 HNY7886FP578W 9459	"P" Option N/A

[Click Here for Graded in Pricing](#)

**2 Select Finish**

Click to view finishes

WWP	WOW
PO01	WNO
PO02	WSO
PO03	WNF(Natural Oak on Flat Cut)
PO07	WSF(Salted Oak on Flat Cut)
PO08	WSF(Salted Oak on Flat Cut)
PO09	WSF(Salted Oak on Flat Cut)
WBW	
WSW	
WEC	

**3 Select Feet Finish**

Click to view edges

WWP	WOW
PO01	WNO
PO02	WSO
PO03	
PO07	
PO08	
PO09	
WBW	
WSW	
WEC	

**4 Select Edge**

Click to view details



High Pressure Laminate Top Upholstered Panels - COM\$

HNY60286FP578G	63257
HNY52886FP578G	55543
HNY45386FP578G	47829
HNY37886FP578G	40115
HNY30386FP578G	32401
HNY22886FP578G	24687
HNY15386FP578G	16973
HNY7886FP578G	9259

GEC	LW04
GNA +5%	LW05
GWL	LW06
LP01	
LF02	
LF03	
LN01	
LA02	
LW01	
LW02	

WWP	WOW
PO01	WNO
PO02	WSO
PO03	
PO07	
PO08	
PO09	
WBW	
WSW	
WEC	

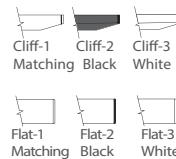

Thermally Fused Laminate Top Upholstered Panels - COM\$

HNY60286FP578M	60201
HNY52886FP578M	52869
HNY45386FP578M	45537
HNY37886FP578M	38205
HNY30386FP578M	30873
HNY22886FP578M	23541
HNY15386FP578M	16209
HNY7886FP578M	8877

MOC
MEC
MSW
MTW
MWL
MNA

WWP	WOW
PO01	WNO
PO02	WSO
PO03	
PO07	
PO08	
PO09	
WEC	
WBW	
WSW	



[Click here to view statement of line](#)

**Product Features**

- HNY7226WT162 Fixed Desk Height worksurfaces, 29" worksurface height
- 5" Solid wood feet - oval shape
- 4 Power outlets with 1 telecom plate, see options below for telecom plate
- Ships KD
- Wire management tray attaches to worksurface top, standard in MFW White, see premium Metal Finish for options
- Hardwire infeed and jumpers are included in workstations
- T75 worksurface wire cutout is standard on all worksurfaces.(T75D: Delete cutout is optional)

**Options**

**Accessories**

- K28: Articulating Keyboard w/ Mouse - \$390
- K31-SK: Center drawer w/ skirt - \$310
- K31: Center drawer w/o skirt - \$205

**Concealed Floor Power Infeed Cover**

- PCEB: White Metal Finish concealed floor power infeed cover - \$150

**Delete Top and Wire Tray**

- DFP: Delete fixed top. Deduct \$1535 Veneer (W), \$1335 High Pressure Laminate (G), \$953 Thermally Fused Laminate (M) per top

**Metal Feet**

- MTL10: Replace solid wood feet with metal feet, standard MFW White - \$55 ea

**Premium Metal Finish**

- Specify premium Metal Finish. MFMB: Matte Black, MFS: Silver, MFSS: Salmon Sienna, MFSA: Surfing Aquavert, MFPS: Pistachio, MFOS: Oyster, MFNA: Navy, MFOL: Olive, MFGB: Grey Beige MFGG: Graphite Gray, MFG: Gray, MFGM:Matte Gold
- Premium Metal Finish for WMT Wire Management Tray - \$75 ea
- Premium Metal Finish for MTL10 Metal Feet - \$20 ea
- Premium Metal Finish for PCEB Concealed Floor Power Infeed Cover - \$35

**Starter Panel**

- RSP: Substitute round starter panel in place of flat starter panel. Must substitute all starters, priced per starter panel - \$83 each. See HNY3555SP888

**Telecom Plates**

- Each power unit has 1 plate. All telecom connectors sold separately.
- RJ45 (1) - \$55, RJ45 (2) - \$110, RJ45 (3) - \$165, USB (1) - \$70, USB (2) - \$140, RJ45/USB - \$125, RJ45/HDMI - \$210, HDMI/USB - \$205

**Worksurface Height**

- THL-42: Modify worksurface height to bar height - N/C

**DARRAN**

**Honey**

Double Hexagon Workstation Typical  
Position 1 Desk with Height Adjustable Worksurface

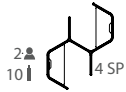

Number of Feet per Typical (MTL10 Option) "SP" Number of Starter Panels per Typical (RSP Option)

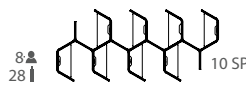
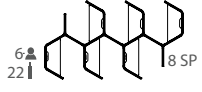
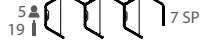
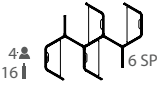
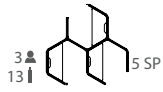

2

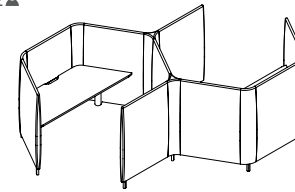

**1 Select Model**

w" x d" x h"	Weight	Standard Veneer Top Upholstered Panels - COM\$	Premium Veneer Top Upholstered Panels - COM\$	High Pressure Laminate Top Upholstered Panels - COM\$	Thermally Fused Laminate Top Upholstered Panels - COM\$
340 x 150 x 55	103	8 HNY340150HA579W 72932	"P" Option N/A	HNY340150HA579G 71324	HNY340150HA579M 68268
303 x 150 x 55	92	7 HNY303150HA579W 64293	"P" Option N/A	HNY303150HA579G 62886	HNY303150HA579M 60212
265 x 150 x 55	80	6 HNY265150HA579W 55804	"P" Option N/A	HNY265150HA579G 54598	HNY265150HA579M 52306
228 x 150 x 55	69	5 HNY228150HA579W 47240	"P" Option N/A	HNY228150HA579G 46235	HNY228150HA579M 44325
191 x 150 x 55	57	4 HNY191150HA579W 38676	"P" Option N/A	HNY191150HA579G 37872	HNY191150HA579M 36344
153 x 150 x 55	46	3 HNY153150HA579W 30037	"P" Option N/A	HNY153150HA579G 29434	HNY153150HA579M 28288
116 x 150 x 55	34	2 HNY116150HA579W 21533	"P" Option N/A	HNY116150HA579G 21131	HNY116150HA579M 20367

**2 Select Finish**

Click to view finishes

WWP	WOW
PO01	WNO
PO02	WSO
PO03	WNF(Natural Oak on Flat Cut)
PO07	WSF(Salted Oak on Flat Cut)
PO08	WSF(Salted Oak on Flat Cut)
PO09	WSF(Salted Oak on Flat Cut)
WBW	
WSW	
WEC	

**3 Select Feet Finish**

Click to view edges

WWP	WOW
PO01	WNO
PO02	WSO
PO03	
PO07	
PO08	
PO09	
WBW	
WSW	
WEC	

**4 Select Edge**

Click to view details



GEC	LW04
GNA +5%	LW05
GWL	LW06
LP01	
LF02	
LF03	
LN01	
LA02	
LW01	
LW02	

WWP	WOW
PO01	WNO
PO02	WSO
PO03	
PO07	
PO08	
PO09	
WBW	
WSW	
WEC	



MOC
MEC
MSW
MTW
MWL
MNA

WWP	WOW
PO01	WNO
PO02	WSO
PO03	
PO07	
PO08	
PO09	
WEC	
WBW	
WSW	



Click here to view statement of line

**Product Features**

- 5" Solid wood feet - oval shape, ships KD
- 4 Power outlets with 1 telecom plate, see options below for telecom plate
- Adjustable height from 27" to 47.5" with a maximum weight capacity of 275 lbs. Lift standard in MFW White, optional MFB Black
- HNY7125WT163 Height Adjustable worksurfaces are included
- Wire management tray attaches to worksurface top, standard in MFW White, see premium Metal Finish for options
- T75 worksurface wire cutout is standard on all worksurfaces.(T75D: Delete cutout is optional)

**Notes**

- 1" Gap between worksurface and panels to drop wires below worksurface
- Metal parts include 5 year warranty
- Programmable height adjustable mechanism, motor includes 2 year warranty

**Options**

**Accessories**

- K28: Articulating Keyboard w/ Mouse - \$390
- K31-SK: Center drawer w/ skirt - \$310
- K31: Center drawer w/o skirt - \$205

**Concealed Floor Power Infeed Cover**

- PCEB: White Metal Finish concealed floor power infeed cover - \$150

**Delete Top and Wire Tray**

- DHAT: Delete height adjustable top. Deduct \$3845 Veneer(W), \$3644 High Pressure Laminate(G), \$3262 Thermally Fused Laminate(M) per top

**Metal Feet**

- MTL10: Replace solid wood feet with metal feet, standard MFW White - \$55 ea

**Premium Metal Finish**

- Specify premium Metal Finish. MFMB: Matte Black, MFS: Silver, MFSS: Salmon Sienna, MFSA: Surfin Aquavert, MFPS: Pistachio, MFOS: Oyster, MFNA: Navy, MFOL: Olive, MFGB: Grey Beige MFGG: Graphite Gray, MFG: Gray, MFGM:Matte Gold
- Premium Metal Finish for WMT Wire Management Tray - \$75 ea
- Premium Metal Finish for MTL10 Metal Feet - \$20 ea
- Premium Metal Finish for PCEB Concealed Floor Power Infeed Cover - \$35

**Starter Panel**

- RSP: Substitute round starter panel in place of flat starter panel. Must substitute all starters, priced per starter panel - \$83 each. See HNY3555SP888

**Telecom Plates**

- Each power unit has 1 plate. All telecom connectors sold separately.
- RJ45 (1) - \$55, RJ45 (2) - \$110, RJ45 (3) - \$165, USB (1) - \$70, USB (2) - \$140, RJ45/USB - \$125, RJ45/HDMI - \$210, HDMI/USB - \$205

Double Hexagon Workstation Typical  
Position 1 Desk with Fixed Worksurface

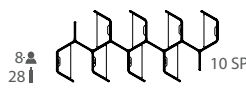
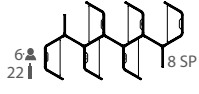
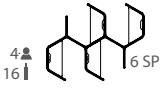
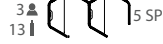
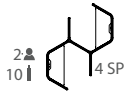

Number of Feet per Typical (MTL10 Option) "SP" Number of Starter Panels per Typical (RSP Option)

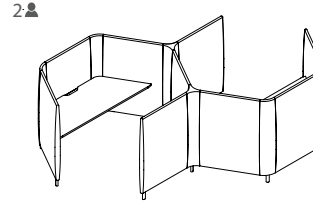

1 Select Model

w" x d" x h"	Weight	Standard Veneer Top Upholstered Panels - COM\$	Premium Veneer Top Upholstered Panels - COM\$
340 x 150 x 55	103	8 HNY340150FT579W 50492	"P" Option N/A
303 x 150 x 55	92	7 HNY303150FT579W 44690	"P" Option N/A
265 x 150 x 55	80	6 HNY265150FT579W 38888	"P" Option N/A
228 x 150 x 55	69	5 HNY228150FT579W 33086	"P" Option N/A
191 x 150 x 55	57	4 HNY191150FT579W 27284	"P" Option N/A
153 x 150 x 55	46	3 HNY153150FT579W 21482	"P" Option N/A
116 x 150 x 55	34	2 HNY116150FT579W 15680	"P" Option N/A

[Click Here for Graded in Pricing](#)

2 Select Finish

Click to view finishes

WWP	WOW
PO01	WNO
PO02	WSO
PO03	WNF(Natural Oak on Flat Cut)
PO07	WSF(Salted Oak on Flat Cut)
PO08	WSF(Salted Oak on Flat Cut)
PO09	WSF(Salted Oak on Flat Cut)
WBW	
WSW	
WEC	

3 Select Feet Finish

Click to view edges

WWP	WOW
PO01	WNO
PO02	WSO
PO03	
PO07	
PO08	
PO09	
WBW	
WSW	
WEC	

4 Select Edge

Click to view details



GEC	LW04
GNA +5%	LW05
GWL	LW06
LP01	
LF02	
LF03	
LN01	
LA02	
LW01	
LW02	

WWP	WOW
PO01	WNO
PO02	WSO
PO03	
PO07	
PO08	
PO09	
WBW	
WSW	
WEC	



MOC
MEC
MSW
MTW
MWL
MNA

WWP	WOW
PO01	WNO
PO02	WSO
PO03	
PO07	
PO08	
PO09	
WBW	
WSW	



High Pressure Laminate Top Upholstered Panels - COM\$

HNY340150FT579G	48892
HNY303150FT579G	43290
HNY265150FT579G	37688
HNY228150FT579G	32086
HNY191150FT579G	26484
HNY153150FT579G	20882
HNY116150FT579G	15280

Thermally Fused Laminate Top Upholstered Panels - COM\$

HNY340150FT579M	45836
HNY303150FT579M	40616
HNY265150FT579M	35396
HNY228150FT579M	30176
HNY191150FT579M	24956
HNY153150FT579M	19736
HNY116150FT579M	14516

[Click here to view statement of line](#)

Product Features

- 5" Solid wood feet - oval shape
- HNY7226WT162 Fixed Desk Height worksurfaces, 29" worksurface height
- Ships KD
- T75 worksurface wire cutout is standard on all worksurfaces.(T75D: Delete cutout is optional)

Options

Accessories

- K28: Articulating Keyboard w/ Mouse - \$390
- K31-SK: Center drawer w/ skirt - \$310
- K31: Center drawer w/o skirt - \$205

Concealed Floor Power Infeed Cover

- PCEB: White Metal Finish concealed floor power infeed cover - \$150

Delete Top

- DFT: Delete fixed top. Deduct \$1325 Veneer(W), \$1125 High Pressure Laminate (G), \$743 Thermally Fused Laminate (M) per top

Metal Feet

- MTL10: Replace solid wood feet with metal feet, standard MFW White - \$55 ea

Premium Metal Finish

- Specify premium Metal Finish. MFMB: Matte Black, MFS: Silver, MFSS: Salmon Sienna, MFSA: Surfing Aquavert, MFPS: Pistachio, MFOS: Oyster, MFNA: Navy, MFOL: Olive, MFGB: Grey Beige MFGG: Graphite Gray, MFG: Gray, MFGM:Matte Gold
- Premium Metal Finish for WMT Wire Management Tray - \$75 ea
- Premium Metal Finish for MTL10 Metal Feet - \$20 ea
- Premium Metal Finish for PCEB Concealed Floor Power Infeed Cover - \$35

Starter Panel

- RSP: Substitute round starter panel in place of flat starter panel. Must substitute all starters, priced per starter panel - \$83 each. See HNY3555SP888

Worksurface Height

- Modify worksurface height to bar height.
- THL-42: Position worksurface at bar height - N/C

Wire Tray

- WMT: Wire metal tray. Mounts under top and comes standard in MFW White - \$210

Double Hexagon Workstation Typical  
Position 1 Desk with Power Fixed Worksurface

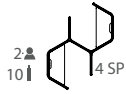

2 people 10' | Number of Feet per Typical (MTL10 Option) "SP" Number of Starter Panels per Typical (RSP Option)

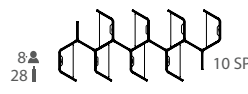
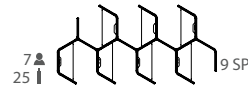
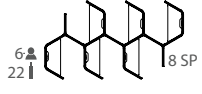
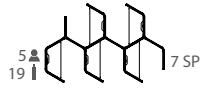
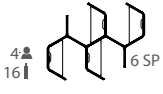
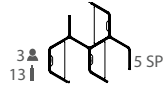

2 people

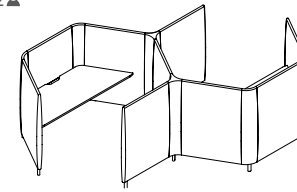

Fixed Top Workstation

Powered Workstation

1 Select Model

w" x d" x h"	Weight	Standard Veneer Top Upholstered Panels - COM\$	Premium Veneer Top Upholstered Panels - COM\$	High Pressure Laminate Top Upholstered Panels - COM\$	Thermally Fused Laminate Top Upholstered Panels - COM\$
340 x 150 x 55	103	8 HNY340150FP579W 54604	"P" Option N/A	HNY340150FP579G 53004	HNY340150FP579M 49948
303 x 150 x 55	92	7 HNY303150FP579W 48256	"P" Option N/A	HNY303150FP579G 46856	HNY303150FP579M 44182
265 x 150 x 55	80	6 HNY265150FP579W 42058	"P" Option N/A	HNY265150FP579G 40858	HNY265150FP579M 38566
228 x 150 x 55	69	5 HNY228150FP579W 35785	"P" Option N/A	HNY228150FP579G 34785	HNY228150FP579M 32875
191 x 150 x 55	57	4 HNY191150FP579W 29512	"P" Option N/A	HNY191150FP579G 28712	HNY191150FP579M 27184
153 x 150 x 55	46	3 HNY153150FP579W 23164	"P" Option N/A	HNY153150FP579G 22564	HNY153150FP579M 21418
116 x 150 x 55	34	2 HNY116150FP579W 16951	"P" Option N/A	HNY116150FP579G 16551	HNY116150FP579M 15787

2 Select Finish

Click to view finishes	WWP	WOW
	PO01	WNO
	PO02	WSO
	PO03	WNF(Natural Oak on Flat Cut)
	PO07	WSF(Salted Oak on Flat Cut)
	PO08	WSF(Salted Oak on Flat Cut)
	PO09	WSF(Salted Oak on Flat Cut)
	WBW	
	WSW	
	WEC	

3 Select Feet Finish

Click to view edges	WWP	WOW
	PO01	WNO
	PO02	WSO
	PO03	
	PO07	
	PO08	
	PO09	
	WBW	
	WSW	
	WEC	

4 Select Edge

Click to view details

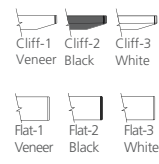

GEC	LW04
GNA +5%	LW05
GWL	LW06
LP01	
LF02	
LF03	
LN01	
LA02	
LW01	
LW02	

WWP	WOW
PO01	WNO
PO02	WSO
PO03	
PO07	
PO08	
PO09	
WBW	
WSW	
WEC	

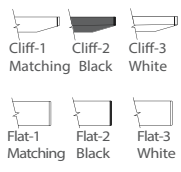

MOC
MEC
MSW
MTW
MWL
MNA

WWP	WOW
PO01	WNO
PO02	WSO
PO03	
PO07	
PO08	
PO09	
WEC	
WBW	
WSW	



[Click here to view statement of line](#)

Product Features

- HNY7226WT162 Fixed Desk Height worksurfaces, 29" worksurface height
- 5" Solid wood feet - oval shape
- 4 Power outlets with 1 telecom plate, see options below for telecom plate
- Ships KD
- Wire management tray attaches to worksurface top, standard in MFW White, see premium Metal Finish for options
- Hardwire infeed and jumpers are included in workstations
- T75 worksurface wire cutout is standard on all worksurfaces.(T75D: Delete cutout is optional)

Options

Accessories

- K28: Articulating Keyboard w/ Mouse - \$390
- K31-SK: Center drawer w/ skirt - \$310
- K31: Center drawer w/o skirt - \$205

Concealed Floor Power Infeed Cover

- PCEB: White Metal Finish concealed floor power infeed cover - \$150

Delete Top and Wire Tray

- DFP: Delete fixed top. Deduct \$1535 Veneer (W), \$1335 High Pressure Laminate (G), \$953 Thermally Fused Laminate (M) per top

Metal Feet

- MTL10: Replace solid wood feet with metal feet, standard MFW White - \$55 ea

Premium Metal Finish

- Specify premium Metal Finish. MFMB: Matte Black, MFS: Silver, MFSS: Salmon Sienna, MFSA: Surfing Aquavert, MFPS: Pistachio, MFOS: Oyster, MFNA: Navy, MFOL: Olive, MFGB: Grey Beige MFGG: Graphite Gray, MFG: Gray, MFGM:Matte Gold
- Premium Metal Finish for WMT Wire Management Tray - \$75 ea
- Premium Metal Finish for MTL10 Metal Feet - \$20 ea
- Premium Metal Finish for PCEB Concealed Floor Power Infeed Cover - \$35

Starter Panel

- RSP: Substitute round starter panel in place of flat starter panel. Must substitute all starters, priced per starter panel - \$83 each. See HNY3555SP888

Telecom Plates

- Each power unit has 1 plate. All telecom connectors sold separately.
- RJ45 (1) - \$55, RJ45 (2) - \$110, RJ45 (3) - \$165, USB (1) - \$70, USB (2) - \$140, RJ45/USB - \$125, RJ45/HDMI - \$210, HDMI/USB - \$205

Worksurface Height

- THL-42: Modify worksurface height to bar height - N/C

**DARRAN**

**Honey**

Double Hexagon Workstation Typical  
Position 2 Desk with Height Adjustable Worksurface

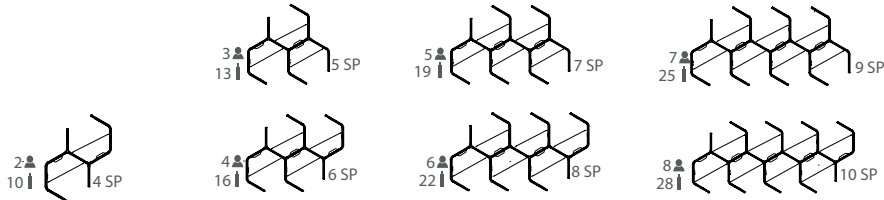

Number of Feet per Typical (MTL10 Option) "SP" Number of Starter Panels per Typical (RSP Option)

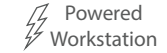
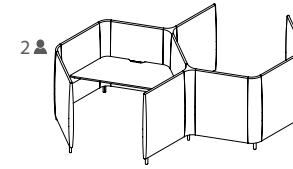

**1 Select Model**

w" x d" x h"	Weight	Standard Veneer Top Upholstered Panels - COM\$	Premium Veneer Top Upholstered Panels - COM\$	High Pressure Laminate Top Upholstered Panels - COM\$	Thermally Fused Laminate Top Upholstered Panels - COM\$
340 x 150 x 55	103	8 HNY340150HA580W 71969	"P" Option N/A	HNY340150HA580G 70361	HNY340150HA580M 67305
303 x 150 x 55	92	7 HNY303150HA580W 63405	"P" Option N/A	HNY303150HA580G 61998	HNY303150HA580M 59324
265 x 150 x 55	80	6 HNY265150HA580W 55112	"P" Option N/A	HNY265150HA580G 53906	HNY265150HA580M 51614
228 x 150 x 55	69	5 HNY228150HA580W 46548	"P" Option N/A	HNY228150HA580G 45543	HNY228150HA580M 43633
191 x 150 x 55	57	4 HNY191150HA580W 38255	"P" Option N/A	HNY191150HA580G 37451	HNY191150HA580M 35923
153 x 150 x 55	46	3 HNY153150HA580W 29691	"P" Option N/A	HNY153150HA580G 29088	HNY153150HA580M 27942
116 x 150 x 55	34	2 HNY116150HA580W 21398	"P" Option N/A	HNY116150HA580G 20996	HNY116150HA580M 20232

[Click Here for Graded in Pricing](#)

**2 Select Finish**

Click to view finishes

WWP	WOW
PO01	WNO
PO02	WSO
PO03	WNF(Natural Oak on Flat Cut)
PO07	WSF(Salted Oak on Flat Cut)
PO08	WSF(Salted Oak on Flat Cut)
PO09	WSF(Salted Oak on Flat Cut)
WBW	
WSW	
WEC	

**3 Select Feet Finish**

Click to view edges

WWP	WOW
PO01	WNO
PO02	WSO
PO03	
PO07	
PO08	
PO09	
WBW	
WSW	
WEC	

**4 Select Edge**

Click to view details



[Click here to view statement of line](#)

**Product Features**

- 5" Solid wood feet - oval shape, ships KD
- 4 Power outlets with 1 telecom plate, see options below for telecom plate
- Adjustable height from 27" to 47.5" with a maximum weight capacity of 275 lbs. Lift standard in MFW White, optional MFB Black
- HNY7125WT163 Height Adjustable worksurfaces are included
- Wire management tray attaches to worksurface top, standard in MFW White, see premium Metal Finish for options
- T75 worksurface wire cutout is standard on all worksurfaces.(T75D: Delete cutout is optional)

**Notes**

- 1" Gap between worksurface and panels to drop wires below worksurface
- Metal parts include 5 year warranty
- Programmable height adjustable mechanism, motor includes 2 year warranty

**Options**

**Accessories**

- K28: Articulating Keyboard w/ Mouse - \$390
- K31-SK: Center drawer w/ skirt - \$310
- K31: Center drawer w/o skirt - \$205

**Concealed Floor Power Infeed Cover**

- PCEB: White Metal Finish concealed floor power infeed cover - \$150

**Delete Top and Wire Tray**

- DHAT: Delete height adjustable top. Deduct \$3845 Veneer(W), \$3644 High Pressure Laminate(G), \$3262 Thermally Fused Laminate(M) per top

**Metal Feet**

- MTL10: Replace solid wood feet with metal feet, standard MFW White - \$55 ea

**Premium Metal Finish**

- Specify premium Metal Finish. MFMB: Matte Black, MFS: Silver, MFSS: Salmon Sienna, MFSA: Surfing Aquavert, MFPS: Pistachio, MFOS: Oyster, MFNA: Navy, MFOL: Olive, MFGB: Grey Beige MFGG: Graphite Gray, MFG: Gray, MFGM:Matte Gold
- Premium Metal Finish for WMT Wire Management Tray - \$75 ea
- Premium Metal Finish for MTL10 Metal Feet - \$20 ea
- Premium Metal Finish for PCEB Concealed Floor Power Infeed Cover - \$35

**Starter Panel**

- RSP: Substitute round starter panel in place of flat starter panel. Must substitute all starters, priced per starter panel - \$83 each. See HNY3555SP888

**Telecom Plates**

- Each power unit has 1 plate. All telecom connectors sold separately.
- RJ45 (1) - \$55, RJ45 (2) - \$110, RJ45 (3) - \$165, USB (1) - \$70, USB (2) - \$140, RJ45/USB - \$125, RJ45/HDMI - \$210, HDMI/USB - \$205



**DARRAN**

**Honey**

Double Hexagon Workstation Typical  
Position 2 Desk with Fixed Worksurface

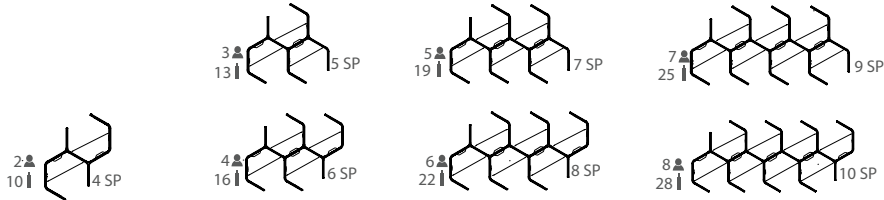

Number of Feet per Typical (MTL10 Option) "SP" Number of Starter Panels per Typical (RSP Option)

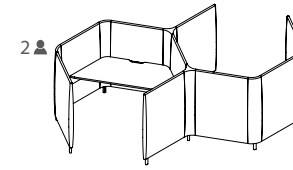

  
Fixed Top  
Workstation

  
Non-Powered  
Workstation

**1 Select Model**

w" x d" x h"	Weight	Standard Veneer Top Upholstered Panels - COM\$	Premium Veneer Top Upholstered Panels - COM\$	High Pressure Laminate Top Upholstered Panels - COM\$	Thermally Fused Laminate Top Upholstered Panels - COM\$
340 x 150 x 55	103	8  HNY340150FT580W 50492	"P" Option N/A	HNY340150FT580G 48892	HNY340150FT580M 45836
303 x 150 x 55	92	7  HNY303150FT580W 44690	"P" Option N/A	HNY303150FT580G 43290	HNY303150FT580M 40616
265 x 150 x 55	80	6  HNY265150FT580W 38888	"P" Option N/A	HNY265150FT580G 37688	HNY265150FT580M 35396
228 x 150 x 55	69	5  HNY228150FT580W 33086	"P" Option N/A	HNY228150FT580G 32086	HNY228150FT580M 30176
191 x 150 x 55	57	4  HNY191150FT580W 27284	"P" Option N/A	HNY191150FT580G 26484	HNY191150FT580M 24956
153 x 150 x 55	46	3  HNY153150FT580W 21482	"P" Option N/A	HNY153150FT580G 20882	HNY153150FT580M 19736
116 x 150 x 55	34	2  HNY116150FT580W 15680	"P" Option N/A	HNY116150FT580G 15280	HNY116150FT580M 14516

[Click Here for Graded in Pricing](#)

**2 Select Finish**

Click to view finishes

WWP	WOW
PO01	WNO
PO02	WSO
PO03	WNF(Natural Oak on Flat Cut)
PO07	WSF(Salted Oak on Flat Cut)
PO08	WSF(Salted Oak on Flat Cut)
PO09	WSF(Salted Oak on Flat Cut)
WBW	
WSW	
WEC	

**3 Select Feet Finish**

Click to view edges

WWP	WOW
PO01	WNO
PO02	WSO
PO03	
PO07	
PO08	
PO09	
WBW	
WSW	
WEC	

**4 Select Edge**

Click to view details



GEC	LW04
GNA +5%	LW05
GWL	LW06
LP01	
LF02	
LF03	
LN01	
LA02	
LW01	
LW02	

WWP	WOW
PO01	WNO
PO02	WSO
PO03	
PO07	
PO08	
PO09	
WBW	
WSW	
WEC	

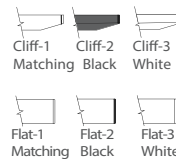

MOC
MEC
MSW
MTW
MWL
MNA

WWP	WOW
PO01	WNO
PO02	WSO
PO03	
PO07	
PO08	
PO09	
WBW	
WSW	



[Click here to view statement of line](#)

**Product Features**

- 5" Solid wood feet - oval shape
- HNY7226WT162 Fixed Desk Height worksurfaces, 29" worksurface height
- Ships KD
- T75 worksurface wire cutout is standard on all worksurfaces.(T75D: Delete cutout is optional)

**Options**

**Accessories**

- K28: Articulating Keyboard w/ Mouse - \$390
- K31-SK: Center drawer w/ skirt - \$310
- K31: Center drawer w/o skirt - \$205

**Concealed Floor Power Infeed Cover**

- PCEB: White Metal Finish concealed floor power infeed cover - \$150

**Delete Top**

- DFT: Delete fixed top. Deduct \$1325 Veneer(W), \$1125 High Pressure Laminate (G), \$743 Thermally Fused Laminate (M) per top

**Metal Feet**

- MTL10: Replace solid wood feet with metal feet, standard MFW White - \$55 ea

**Premium Metal Finish**

- Specify premium Metal Finish. MFMB: Matte Black, MFS: Silver, MFSS: Salmon Sienna, MFSA: Surfing Aquavert, MFPS: Pistachio, MFOS: Oyster, MFNA: Navy, MFOL: Olive, MFGB: Grey Beige MFGG: Graphite Gray, MFG: Gray, MFGM:Matte Gold
- Premium Metal Finish for WMT Wire Management Tray - \$75 ea
- Premium Metal Finish for MTL10 Metal Feet - \$20 ea
- Premium Metal Finish for PCEB Concealed Floor Power Infeed Cover - \$35

**Starter Panel**

- RSP: Substitute round starter panel in place of flat starter panel. Must substitute all starters, priced per starter panel - \$83 each. See HNY3555SP888

**Worksurface Height**

- Modify worksurface height to bar height.
- THL-42: Position worksurface at bar height - N/C

**Wire Tray**

- WMT: Wire metal tray. Mounts under top and comes standard in MFW White - \$210

**DARRAN**

**Honey**

Double Hexagon Workstation Typical  
Position 2 Desk with Power Fixed Worksurface

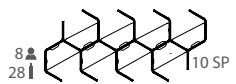
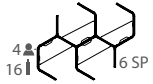
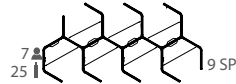
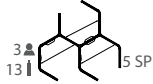
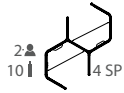

Number of Feet per Typical (MTL10 Option) "SP" Number of Starter Panels per Typical (RSP Option)

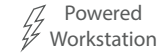
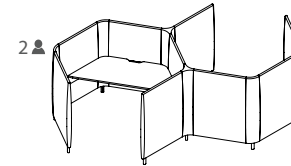

**1 Select Model**

w" x d" x h"	Weight	Standard Veneer Top Upholstered Panels - COM\$	Premium Veneer Top Upholstered Panels - COM\$	High Pressure Laminate Top Upholstered Panels - COM\$	Thermally Fused Laminate Top Upholstered Panels - COM\$
340 x 150 x 55	103	8 HNY340150FP580W 53641	"P" Option N/A	HNY340150FP580G 52041	HNY340150FP580M 48985
303 x 150 x 55	92	7 HNY303150FP580W 47368	"P" Option N/A	HNY303150FP580G 45968	HNY303150FP580M 43294
265 x 150 x 55	80	6 HNY265150FP580W 41366	"P" Option N/A	HNY265150FP580G 40166	HNY265150FP580M 37874
228 x 150 x 55	69	5 HNY228150FP580W 35093	"P" Option N/A	HNY228150FP580G 34093	HNY228150FP580M 32183
191 x 150 x 55	57	4 HNY191150FP580W 29091	"P" Option N/A	HNY191150FP580G 28291	HNY191150FP580M 26763
153 x 150 x 55	46	3 HNY153150FP580W 22818	"P" Option N/A	HNY153150FP580G 22218	HNY153150FP580M 21072
116 x 150 x 55	34	2 HNY116150FP580W 16816	"P" Option N/A	HNY116150FP580G 16416	HNY116150FP580M 15652

[Click Here for Graded in Pricing](#)

**2 Select Finish**

Click to view finishes

WWP	WOW
PO01	WNO
PO02	WSO
PO03	WNF(Natural Oak on Flat Cut)
PO07	WSF(Salted Oak on Flat Cut)
PO08	WSF(Salted Oak on Flat Cut)
PO09	WSF(Salted Oak on Flat Cut)
WBW	
WSW	
WEC	

**3 Select Feet Finish**

Click to view edges

WWP	WOW
PO01	WNO
PO02	WSO
PO03	
PO07	
PO08	
PO09	
WBW	
WSW	
WEC	

**4 Select Edge**

Click to view details

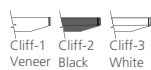

GEC	LW04
GNA +5%	LW05
GWL	LW06
LP01	
LF02	
LF03	
LN01	
LA02	
LW01	
LW02	

WWP	WOW
PO01	WNO
PO02	WSO
PO03	
PO07	
PO08	
PO09	
WBW	
WSW	
WEC	



MOC
MEC
MSW
MTW
MWL
MNA

WWP	WOW
PO01	WNO
PO02	WSO
PO03	
PO07	
PO08	
PO09	
WEC	
WBW	
WSW	



[Click here to view statement of line](#)

**Product Features**

- HNY7226WT162 Fixed Desk Height worksurfaces, 29" worksurface height
- 5" Solid wood feet - oval shape
- 4 Power outlets with 1 telecom plate, see options below for telecom plate
- Ships KD
- Wire management tray attaches to worksurface top, standard in MFW White, see premium Metal Finish for options
- Hardwire infeed and jumpers are included in workstations
- T75 worksurface wire cutout is standard on all worksurfaces.(T75D: Delete cutout is optional)

**Options**

**Accessories**

- K28: Articulating Keyboard w/ Mouse - \$390
- K31-SK: Center drawer w/ skirt - \$310
- K31: Center drawer w/o skirt - \$205

**Concealed Floor Power Infeed Cover**

- PCEB: White Metal Finish concealed floor power infeed cover - \$150

**Delete Top and Wire Tray**

- DFP: Delete fixed top. Deduct \$1535 Veneer (W), \$1335 High Pressure Laminate (G), \$953 Thermally Fused Laminate (M) per top

**Metal Feet**

- MTL10: Replace solid wood feet with metal feet, standard MFW White - \$55 ea

**Premium Metal Finish**

- Specify premium Metal Finish. MFMB: Matte Black, MFS: Silver, MFSS: Salmon Sienna, MFSA: Surfing Aquavert, MFPS: Pistachio, MFOS: Oyster, MFNA: Navy, MFOL: Olive, MFGB: Grey Beige MFGG: Graphite Gray, MFG: Gray, MFGM:Matte Gold
- Premium Metal Finish for WMT Wire Management Tray - \$75 ea
- Premium Metal Finish for MTL10 Metal Feet - \$20 ea
- Premium Metal Finish for PCEB Concealed Floor Power Infeed Cover - \$35

**Starter Panel**

- RSP: Substitute round starter panel in place of flat starter panel. Must substitute all starters, priced per starter panel - \$83 each. See HNY3555SP888

**Telecom Plates**

- Each power unit has 1 plate. All telecom connectors sold separately.
- RJ45 (1) - \$55, RJ45 (2) - \$110, RJ45 (3) - \$165, USB (1) - \$70, USB (2) - \$140, RJ45/USB - \$125, RJ45/HDMI - \$210, HDMI/USB - \$205

**Worksurface Height**

- THL-42: Modify worksurface height to bar height - N/C

# DARRAN

# Honey

## Double Hexagon Workstation Typical Position 3 Desk with Height Adjustable Worksurface

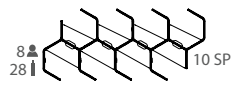
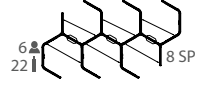
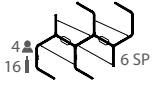
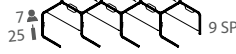
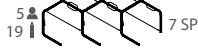
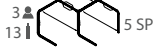
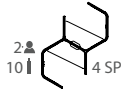

Number of Feet per Typical (MTL10 Option) "SP" Number of Starter Panels per Typical (RSP Option)

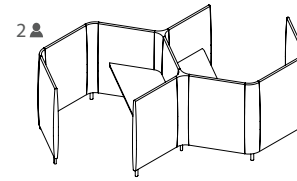

Height Adjustable Workstation

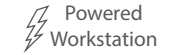

Powered Workstation

### 1 Select Model

w" x d" x h"	Weight	Standard Veneer Top Upholstered Panels - COM\$	Premium Veneer Top Upholstered Panels - COM\$	High Pressure Laminate Top Upholstered Panels - COM\$	Thermally Fused Laminate Top Upholstered Panels - COM\$
340 x 150 x 55	103	8 HNY340150HA581W 71698	"P" Option N/A	HNY340150HA581G 70090	HNY340150HA581M 67034
303 x 150 x 55	92	7 HNY303150HA581W 63405	"P" Option N/A	HNY303150HA581G 61998	HNY303150HA581M 59324
265 x 150 x 55	80	6 HNY265150HA581W 54841	"P" Option N/A	HNY265150HA581G 53635	HNY265150HA581M 51343
228 x 150 x 55	69	5 HNY228150HA581W 46548	"P" Option N/A	HNY228150HA581G 45543	HNY228150HA581M 43633
191 x 150 x 55	57	4 HNY191150HA581W 37984	"P" Option N/A	HNY191150HA581G 37180	HNY191150HA581M 35652
153 x 150 x 55	46	3 HNY153150HA581W 29691	"P" Option N/A	HNY153150HA581G 29088	HNY153150HA581M 27942
116 x 150 x 55	34	2 HNY116150HA581W 21127	"P" Option N/A	HNY116150HA581G 20725	HNY116150HA581M 19961

[Click Here for Graded in Pricing](#)

### 2 Select Finish

Click to view finishes

WWP	WOW
PO01	WNO
PO02	WSO
PO03	WNF(Natural Oak on Flat Cut)
PO07	WSF(Salted Oak on Flat Cut)
PO08	WSF(Salted Oak on Flat Cut)
PO09	WSF(Salted Oak on Flat Cut)
WBW	
WSW	
WEC	

### 3 Select Feet Finish

Click to view edges

WWP	WOW
PO01	WNO
PO02	WSO
PO03	
PO07	
PO08	
PO09	
WBW	
WSW	
WEC	

### 4 Select Edge

Click to view details

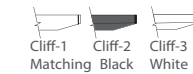

[Click here to view statement of line](#)

### Product Features

- 5" Solid wood feet - oval shape, ships KD
- 4 Power outlets with 1 telecom plate, see options below for telecom plate
- Adjustable height from 27" to 47.5" with a maximum weight capacity of 275 lbs.
- Lift standard in MFW White, optional MFB Black
- HNY7125WT163 Height Adjustable worksurfaces are included
- Wire management tray attaches to worksurface top, standard in MFW White, see premium Metal Finish for options
- T75 worksurface wire cutout is standard on all worksurfaces.(T75D: Delete cutout is optional)

### Notes

- 1" Gap between worksurface and panels to drop wires below worksurface
- Metal parts include 5 year warranty
- Programmable height adjustable mechanism, motor includes 2 year warranty

### Options

#### Accessories

- K28: Articulating Keyboard w/ Mouse - \$390
- K31-SK: Center drawer w/ skirt - \$310
- K31: Center drawer w/o skirt - \$205

#### Concealed Floor Power Infeed Cover

- PCEB: White Metal Finish concealed floor power infeed cover - \$150

#### Delete Top and Wire Tray

- DHAT: Delete height adjustable top. Deduct \$3845 Veneer(W), \$3644 High Pressure Laminate(G), \$3262 Thermally Fused Laminate(M) per top

#### Metal Feet

- MTL10: Replace solid wood feet with metal feet, standard MFW White - \$55 ea

#### Premium Metal Finish

- Specify premium Metal Finish. MFMB: Matte Black, MFS: Silver, MFSS: Salmon Sienna, MFSA: Surfin Aquavert, MFPS: Pistachio, MFOS: Oyster, MFNA: Navy, MFOL: Olive, MFGB: Grey Beige MFGG: Graphite Gray, MFG: Gray, MFGM:Matte Gold
- Premium Metal Finish for WMT Wire Management Tray - \$75 ea
- Premium Metal Finish for MTL10 Metal Feet - \$20 ea
- Premium Metal Finish for PCEB Concealed Floor Power Infeed Cover - \$35

#### Starter Panel

- RSP: Substitute round starter panel in place of flat starter panel. Must substitute all starters, priced per starter panel - \$83 each. See HNY3555SP888

#### Telecom Plates

- Each power unit has 1 plate. All telecom connectors sold separately.
- RJ45 (1) - \$55, RJ45 (2) - \$110, RJ45 (3) - \$165, USB (1) - \$70, USB (2) - \$140, RJ45/USB - \$125, RJ45/HDMI - \$210, HDMI/USB - \$205

**DARRAN**

**Honey** Double Hexagon Workstation Typical  
Position 3 Desk with Fixed Worksurface

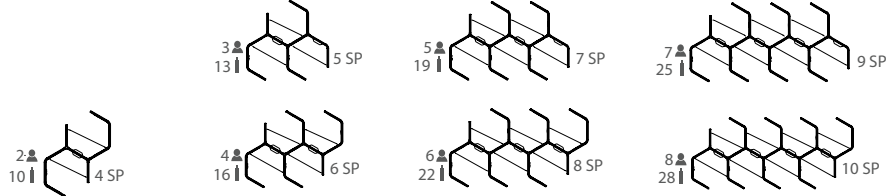

Number of Feet per Typical (MTL10 Option) "SP" Number of Starter Panels per Typical (RSP Option)

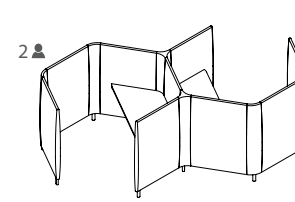

Fixed Top Workstation

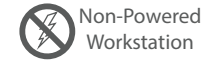

Non-Powered Workstation

**1 Select Model**

w" x d" x h"	Weight	Standard Veneer Top Upholstered Panels - COM\$	Premium Veneer Top Upholstered Panels - COM\$
340 x 150 x 55	103	8 HNY340150FT581W 50492	"P" Option N/A
303 x 150 x 55	92	7 HNY303150FT581W 44690	"P" Option N/A
265 x 150 x 55	80	6 HNY265150FT581W 38888	"P" Option N/A
228 x 150 x 55	69	5 HNY228150FT581W 33086	"P" Option N/A
191 x 150 x 55	57	4 HNY191150FT581W 27284	"P" Option N/A
153 x 150 x 55	46	3 HNY153150FT581W 21482	"P" Option N/A
116 x 150 x 55	34	2 HNY116150FT581W 15680	"P" Option N/A

[Click Here for Graded in Pricing](#)

**2 Select Finish**

Click to view finishes

WWP	WOW
PO01	WNO
PO02	WSO
PO03	WNF(Natural Oak on Flat Cut)
PO07	WSF(Salted Oak on Flat Cut)
PO08	WSF(Salted Oak on Flat Cut)
PO09	WSF(Salted Oak on Flat Cut)
WBW	
WSW	
WEC	

**3 Select Feet Finish**

Click to view edges

WWP	WOW
PO01	WNO
PO02	WSO
PO03	
PO07	
PO08	
PO09	
WBW	
WSW	
WEC	

**4 Select Edge**

Click to view details



GEC	LW04
GNA +5%	LW05
GWL	LW06
LP01	
LF02	
LF03	
LN01	
LA02	
LW01	
LW02	

WWP	WOW
PO01	WNO
PO02	WSO
PO03	
PO07	
PO08	
PO09	
WBW	
WSW	
WEC	



**Thermally Fused Laminate Top Upholstered Panels - COM\$**

HNY340150FT581M	45836
HNY303150FT581M	40616
HNY265150FT581M	35396
HNY228150FT581M	30176
HNY191150FT581M	24956
HNY153150FT581M	19736
HNY116150FT581M	14516

MOC
MEC
MSW
MTW
MWL
MNA

WWP	WOW
PO01	WNO
PO02	WSO
PO03	
PO07	
PO08	
PO09	
WBW	
WSW	



[Click here to view statement of line](#)

**Product Features**

- 5" Solid wood feet - oval shape
- HNY7226WT162 Fixed Desk Height worksurfaces, 29" worksurface height
- Ships KD
- T75 worksurface wire cutout is standard on all worksurfaces.(T75D: Delete cutout is optional)

**Options**

**Accessories**

- K28: Articulating Keyboard w/ Mouse - \$390
- K31-SK: Center drawer w/ skirt - \$310
- K31: Center drawer w/o skirt - \$205

**Concealed Floor Power Infeed Cover**

- PCEB: White Metal Finish concealed floor power infeed cover - \$150

**Delete Top**

- DFT: Delete fixed top. Deduct \$1325 Veneer(W), \$1125 High Pressure Laminate (G), \$743 Thermally Fused Laminate (M) per top

**Metal Feet**

- MTL10: Replace solid wood feet with metal feet, standard MFW White - \$55 ea

**Premium Metal Finish**

- Specify premium Metal Finish. MFMB: Matte Black, MFS: Silver, MFSS: Salmon Sienna, MFSA: Surfing Aquavert, MFPS: Pistachio, MFOS: Oyster, MFNA: Navy, MFOL: Olive, MFGB: Grey Beige MFGG: Graphite Gray, MFG: Gray, MFGM:Matte Gold
- Premium Metal Finish for WMT Wire Management Tray - \$75 ea
- Premium Metal Finish for MTL10 Metal Feet - \$20 ea
- Premium Metal Finish for PCEB Concealed Floor Power Infeed Cover - \$35

**Starter Panel**

- RSP: Substitute round starter panel in place of flat starter panel. Must substitute all starters, priced per starter panel - \$83 each. See HNY3555SP888

**Worksurface Height**

- Modify worksurface height to bar height.
- THL-42: Position worksurface at bar height - N/C

**Wire Tray**

- WMT: Wire metal tray. Mounts under top and comes standard in MFW White - \$210

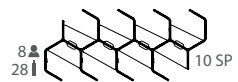
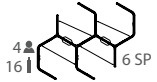
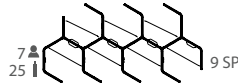
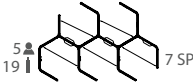
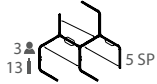
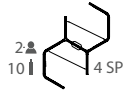

Number of Feet per Typical (MTL10 Option) "SP" Number of Starter Panels per Typical (RSP Option)

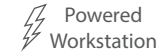
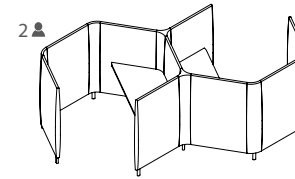

1 Select Model

w" x d" x h"	Weight	Standard Veneer Top Upholstered Panels - COM\$	Premium Veneer Top Upholstered Panels - COM\$	High Pressure Laminate Top Upholstered Panels - COM\$	Thermally Fused Laminate Top Upholstered Panels - COM\$
340 x 150 x 55	103	8 HNY340150FP581W 53370	"P" Option N/A	HNY340150FP581G 51770	HNY340150FP581M 48714
303 x 150 x 55	92	7 HNY303150FP581W 47368	"P" Option N/A	HNY303150FP581G 45968	HNY303150FP581M 43294
265 x 150 x 55	80	6 HNY265150FP581W 41095	"P" Option N/A	HNY265150FP581G 39895	HNY265150FP581M 37603
228 x 150 x 55	69	5 HNY228150FP581W 35093	"P" Option N/A	HNY228150FP581G 34093	HNY228150FP581M 32183
191 x 150 x 55	57	4 HNY191150FP581W 28820	"P" Option N/A	HNY191150FP581G 28020	HNY191150FP581M 26492
153 x 150 x 55	46	3 HNY153150FP581W 22818	"P" Option N/A	HNY153150FP581G 22218	HNY153150FP581M 21072
116 x 150 x 55	34	2 HNY116150FP581W 16545	"P" Option N/A	HNY116150FP581G 16145	HNY116150FP581M 15381

[Click Here for Graded in Pricing](#)

2 Select Finish

Click to view finishes

WWP	WOW
PO01	WNO
PO02	WSO
PO03	WNF(Natural Oak on Flat Cut)
PO07	WSF(Salted Oak on Flat Cut)
PO08	WSF(Salted Oak on Flat Cut)
PO09	WSF(Salted Oak on Flat Cut)
WBW	
WSW	
WEC	

3 Select Feet Finish

Click to view edges

WWP	WOW
PO01	WNO
PO02	WSO
PO03	
PO07	
PO08	
PO09	
WBW	
WSW	
WEC	

4 Select Edge

Click to view details

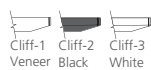

GEC	LW04
GNA +5%	LW05
GWL	LW06
LP01	
LF02	
LF03	
LN01	
LA02	
LW01	
LW02	

WWP	WOW
PO01	WNO
PO02	WSO
PO03	
PO07	
PO08	
PO09	
WBW	
WSW	
WEC	



MOC
MEC
MSW
MTW
MWL
MNA

WWP	WOW
PO01	WNO
PO02	WSO
PO03	
PO07	
PO08	
PO09	
WEC	
WBW	
WSW	



[Click here to view statement of line](#)

Product Features

- HNY7226WT162 Fixed Desk Height worksurfaces, 29" worksurface height
- 5" Solid wood feet - oval shape
- 4 Power outlets with 1 telecom plate, see options below for telecom plate
- Ships KD
- Wire management tray attaches to worksurface top, standard in MFW White, see premium Metal Finish for options
- Hardwire infeed and jumpers are included in workstations
- T75 worksurface wire cutout is standard on all worksurfaces.(T75D: Delete cutout is optional)

Options

Accessories

- K28: Articulating Keyboard w/ Mouse - \$390
- K31-SK: Center drawer w/ skirt - \$310
- K31: Center drawer w/o skirt - \$205

Concealed Floor Power Infeed Cover

- PCEB: White Metal Finish concealed floor power infeed cover - \$150

Delete Top and Wire Tray

- DFP: Delete fixed top. Deduct \$1535 Veneer (W), \$1335 High Pressure Laminate (G), \$953 Thermally Fused Laminate (M) per top

Metal Feet

- MTL10: Replace solid wood feet with metal feet, standard MFW White - \$55 ea

Premium Metal Finish

- Specify premium Metal Finish. MFMB: Matte Black, MFS: Silver, MFSS: Salmon Sienna, MFSA: Surfing Aquavert, MFPS: Pistachio, MFOS: Oyster, MFNA: Navy, MFOL: Olive, MFGB: Grey Beige MFGG: Graphite Gray, MFG: Gray, MFGM:Matte Gold
- Premium Metal Finish for WMT Wire Management Tray - \$75 ea
- Premium Metal Finish for MTL10 Metal Feet - \$20 ea
- Premium Metal Finish for PCEB Concealed Floor Power Infeed Cover - \$35

Starter Panel

- RSP: Substitute round starter panel in place of flat starter panel. Must substitute all starters, priced per starter panel - \$83 each. See HNY3555SP888

Telecom Plates

- Each power unit has 1 plate. All telecom connectors sold separately.
- RJ45 (1) - \$55, RJ45 (2) - \$110, RJ45 (3) - \$165, USB (1) - \$70, USB (2) - \$140, RJ45/USB - \$125, RJ45/HDMI - \$210, HDMI/USB - \$205

Worksurface Height

- THL-42: Modify worksurface height to bar height - N/C

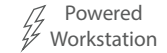
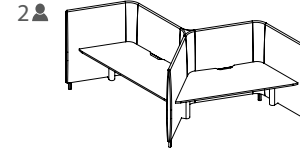
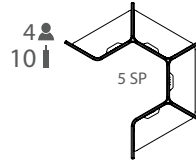
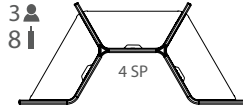
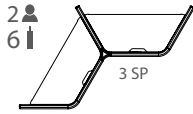
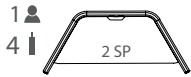

Number of Feet per Typical (MTL10 Option) "SP" Number of Starter Panels per Typical (RSP Option)

1 Select Model

w" x d" x h"	Weight	Standard Veneer Top Upholstered Panels - COM\$	Premium Veneer Top Upholstered Panels - COM\$	High Pressure Laminate Top Upholstered Panels - COM\$	Thermally Fused Laminate Top Upholstered Panels - COM\$
166 x 145 x 55	34	4 HNY166145HA582W 29027	"P" Option N/A	HNY166145HA582G 28223	HNY166145HA582M 26695
166 x 74 x 55	26	3 HNY16674HA582W 22174	"P" Option N/A	HNY16674HA582G 21571	HNY16674HA582M 20425
125 x 74 x 55	19	2 HNY12574HA582W 15321	"P" Option N/A	HNY12574HA582G 14919	HNY12574HA582M 14155
85 x 37 x 55	11	1 HNY8537HA582W 8468	"P" Option N/A	HNY8537HA582G 8267	HNY8537HA582M 7885

[Click Here for Graded in Pricing](#)

2 Select Finish

Click to view finishes

WWP	WOW
PO01	WNO
PO02	WSO
PO03	WNF(Natural Oak on Flat Cut)
PO07	WSF(Salted Oak on Flat Cut)
PO08	
PO09	
WBW	
WSW	
WEC	

3 Select Feet Finish

Click to view edges

WWP	WOW
PO01	WNO
PO02	WSO
PO03	
PO07	
PO08	
PO09	
WBW	
WSW	
WEC	

4 Select Edge

Click to view details



GEC	LW04
GNA +5%	LW05
GWL	LW06
LP01	
LF02	
LF03	
LN01	
LA02	
LW01	
LW02	

WWP	WOW
PO01	WNO
PO02	WSO
PO03	
PO07	
PO08	
PO09	
WBW	
WSW	
WEC	



MOC
MEC
MSW
MTW
MWL
MNA

WWP	WOW
PO01	WNO
PO02	WSO
PO03	
PO07	
PO08	
PO09	
WEC	
WBW	
WSW	



[Click here to view statement of line](#)

Product Features

- 5" Solid wood feet - oval shape, ships KD
- 4 Power outlets with 1 telecom plate, see options below for telecom plate
- Adjustable height from 27" to 47.5" with a maximum weight capacity of 275 lbs.
- Lift standard in MFW White, optional MFB Black
- HNY7125WT163 Height Adjustable worksurfaces are included
- Wire management tray attaches to worksurface top, standard in MFW White, see premium Metal Finish for options
- T75 worksurface wire cutout is standard on all worksurfaces.(T75D: Delete cutout is optional)

Notes

- 1" Gap between worksurface and panels to drop wires below worksurface
- Metal parts include 5 year warranty
- Programmable height adjustable mechanism, motor includes 2 year warranty

Options

Accessories

- K28: Articulating Keyboard w/ Mouse - \$390
- K31-SK: Center drawer w/ skirt - \$310
- K31: Center drawer w/o skirt - \$205

Concealed Floor Power Infeed Cover

- PCEB: White Metal Finish concealed floor power infeed cover - \$150

Delete Top and Wire Tray

- DHAT: Delete height adjustable top. Deduct \$3845 Veneer(W), \$3644 High Pressure Laminate(G), \$3262 Thermally Fused Laminate(M) per top

Metal Feet

- MTL10: Replace solid wood feet with metal feet, standard MFW White - \$55 ea

Premium Metal Finish

- Specify premium Metal Finish. MFMB: Matte Black, MFS: Silver, MFSS: Salmon Sienna, MFSA: Surfin Aquavert, MFPS: Pistachio, MFOS: Oyster, MFNA: Navy, MFOL: Olive, MFGB: Grey Beige MFGG: Graphite Gray, MFG: Gray, MFGM:Matte Gold
- Premium Metal Finish for WMT Wire Management Tray - \$75 ea
- Premium Metal Finish for MTL10 Metal Feet - \$20 ea
- Premium Metal Finish for PCEB Concealed Floor Power Infeed Cover - \$35

Starter Panel

- RSP: Substitute round starter panel in place of flat starter panel. Must substitute all starters, priced per starter panel - \$83 each. See HNY3555SP888

Telecom Plates

- Each power unit has 1 plate. All telecom connectors sold separately.
- RJ45 (1) - \$55, RJ45 (2) - \$110, RJ45 (3) - \$165, USB (1) - \$70, USB (2) - \$140, RJ45/USB - \$125, RJ45/HDMI - \$210, HDMI/USB - \$205

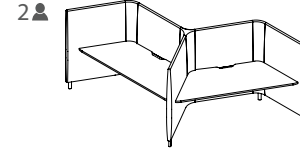
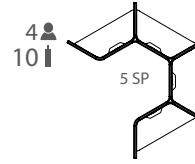
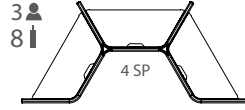
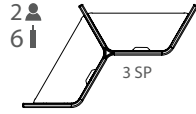

Number of Feet per Typical (MTL10 Option) "SP" Number of Starter Panels per Typical (RSP Option)

1 Select Model

w" x d" x h"	Weight	Standard Veneer Top Upholstered Panels - COM\$	Premium Veneer Top Upholstered Panels - COM\$
166 x 145 x 55	34	4 HNY166145FT582W 18290	"P" Option N/A
166 x 74 x 55	26	3 HNY16674FT582W 14070	"P" Option N/A
125 x 74 x 55	19	2 HNY12574FT582W 9850	"P" Option N/A
85 x 37 x 55	11	1 HNY8537FT582W 5630	"P" Option N/A

[Click Here for Graded in Pricing](#)

2 Select Finish

Click to view finishes

WWP	WOW
PO01	WNO
PO02	WSO
PO03	WNF(Natural Oak on Flat Cut)
PO07	WSF(Salted Oak on Flat Cut)
PO08	
PO09	
WBW	
WSW	
WEC	

3 Select Feet Finish

Click to view edges

WWP	WOW
PO01	WNO
PO02	WSO
PO03	
PO07	
PO08	
PO09	
WBW	
WSW	
WEC	

4 Select Edge

Click to view details

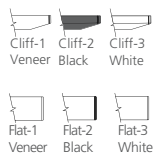

High Pressure Laminate Top Veneer CFTssis

HNY166145FT582G	17490
HNY16674FT582G	13470
HNY12574FT582G	9450
HNY8537FT582G	5430

GEC	LW04
GNA +5%	LW05
GWL	LW06
LP01	
LF02	
LF03	
LN01	
LA02	
LW01	
LW02	

WWP	WOW
PO01	WNO
PO02	WSO
PO03	
PO07	
PO08	
PO09	
WBW	
WSW	
WEC	

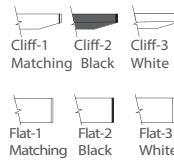

Thermally Fused Laminate Top Upholstered Panels - COM\$

HNY166145FT582M	15962
HNY16674FT582M	12324
HNY12574FT582M	8686
HNY8537FT582M	5048

MOC
MEC
MSW
MTW
MWL
MNA

WWP	WOW
PO01	WNO
PO02	WSO
PO03	
PO07	
PO08	
PO09	
WBW	
WSW	



[Click here to view statement of line](#)

Product Features

- 5" Solid wood feet - oval shape
- HNY7226WT162 Fixed Desk Height worksurfaces, 29" worksurface height
- Ships KD
- T75 worksurface wire cutout is standard on all worksurfaces.(T75D: Delete cutout is optional)

Options

Accessories

- K28: Articulating Keyboard w/ Mouse - \$390
- K31-SK: Center drawer w/ skirt - \$310
- K31: Center drawer w/o skirt - \$205

Concealed Floor Power Infeed Cover

- PCEB: White Metal Finish concealed floor power infeed cover - \$150

Delete Top

- DFT: Delete fixed top. Deduct \$1325 Veneer(W), \$1125 High Pressure Laminate (G), \$743 Thermally Fused Laminate (M) per top

Metal Feet

- MTL10: Replace solid wood feet with metal feet, standard MFW White - \$55 ea

Premium Metal Finish

- Specify premium Metal Finish. MFMB: Matte Black, MFS: Silver, MFSS: Salmon Sienna, MFSA: Surfing Aquavert, MFPS: Pistachio, MFOS: Oyster, MFNA: Navy, MFOL: Olive, MFGB: Grey Beige MFGG: Graphite Gray, MFG: Gray, MFGM:Matte Gold
- Premium Metal Finish for WMT Wire Management Tray - \$75 ea
- Premium Metal Finish for MTL10 Metal Feet - \$20 ea
- Premium Metal Finish for PCEB Concealed Floor Power Infeed Cover - \$35

Starter Panel

- RSP: Substitute round starter panel in place of flat starter panel. Must substitute all starters, priced per starter panel - \$83 each. See HNY3555SP888

Worksurface Height

- Modify worksurface height to bar height.
- THL-42: Position worksurface at bar height - N/C

Wire Tray

- WMT: Wire metal tray. Mounts under top and comes standard in MFW White - \$210

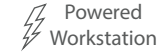
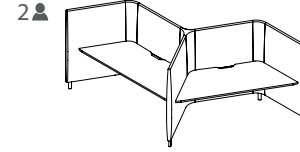
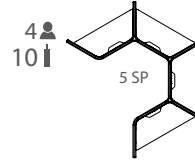
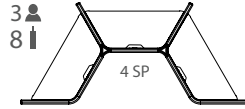
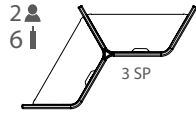

Number of Feet per Typical (MTL10 Option) "SP" Number of Starter Panels per Typical (RSP Option)

1 Select Model

w" x d" x h"	Weight	Standard Veneer Top Upholstered Panels - COM\$	Premium Veneer Top Upholstered Panels - COM\$
166 x 145 x 55	34	4 HNY166145FP582W 19863	"P" Option N/A
166 x 74 x 55	26	3 HNY16674FP582W 15301	"P" Option N/A
125 x 74 x 55	19	2 HNY12574FP582W 10739	"P" Option N/A
85 x 37 x 55	11	1 HNY8537FP582W 6177	"P" Option N/A

[Click Here for Graded in Pricing](#)

2 Select Finish

Click to view finishes

WWP	WOW
PO01	WNO
PO02	WSO
PO03	WNF(Natural Oak on Flat Cut)
PO07	WSF(Salted Oak on Flat Cut)
PO08	WSF(Salted Oak on Flat Cut)
PO09	WSF(Salted Oak on Flat Cut)
WBW	
WSW	
WEC	

3 Select Feet Finish

Click to view edges

WWP	WOW
PO01	WNO
PO02	WSO
PO03	
PO07	
PO08	
PO09	
WBW	
WSW	
WEC	

4 Select Edge

Click to view details

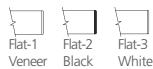

High Pressure Laminate Top Upholstered Panels - COM\$

HNY166145FP582G	19063
HNY16674FP582G	14701
HNY12574FP582G	10339
HNY8537FP582G	5977

GEC	LW04
GNA +5%	LW05
GWL	LW06
LP01	
LF02	
LF03	
LN01	
LA02	
LW01	
LW02	

WWP	WOW
PO01	WNO
PO02	WSO
PO03	
PO07	
PO08	
PO09	
WBW	
WSW	
WEC	



Thermally Fused Laminate Top Upholstered Panels - COM\$

HNY166145FP582M	17535
HNY16674FP582M	13555
HNY12574FP582M	9575
HNY8537FP582M	5595

MOC
MEC
MSW
MTW
MWL
MNA

WWP	WOW
PO01	WNO
PO02	WSO
PO03	
PO07	
PO08	
PO09	
WEC	
WBW	
WSW	



[Click here to view statement of line](#)

Product Features

- HNY7226WT162 Fixed Desk Height worksurfaces, 29" worksurface height
- 5" Solid wood feet - oval shape
- 4 Power outlets with 1 telecom plate, see options below for telecom plate
- Ships KD
- Wire management tray attaches to worksurface top, standard in MFW White, see premium Metal Finish for options
- Hardwire infeed and jumpers are included in workstations
- T75 worksurface wire cutout is standard on all worksurfaces.(T75D: Delete cutout is optional)

Options

Accessories

- K28: Articulating Keyboard w/ Mouse - \$390
- K31-SK: Center drawer w/ skirt - \$310
- K31: Center drawer w/o skirt - \$205

Concealed Floor Power Infeed Cover

- PCEB: White Metal Finish concealed floor power infeed cover - \$150

Delete Top and Wire Tray

- DFP: Delete fixed top. Deduct \$1535 Veneer (W), \$1335 High Pressure Laminate (G), \$953 Thermally Fused Laminate (M) per top

Metal Feet

- MTL10: Replace solid wood feet with metal feet, standard MFW White - \$55 ea

Premium Metal Finish

- Specify premium Metal Finish. MFMB: Matte Black, MFS: Silver, MFSS: Salmon Sienna, MFSA: Surfing Aquavert, MFPS: Pistachio, MFOS: Oyster, MFNA: Navy, MFOL: Olive, MFGB: Grey Beige MFGG: Graphite Gray, MFG: Gray, MFGM:Matte Gold
- Premium Metal Finish for WMT Wire Management Tray - \$75 ea
- Premium Metal Finish for MTL10 Metal Feet - \$20 ea
- Premium Metal Finish for PCEB Concealed Floor Power Infeed Cover - \$35

Starter Panel

- RSP: Substitute round starter panel in place of flat starter panel. Must substitute all starters, priced per starter panel - \$83 each. See HNY3555SP888

Telecom Plates

- Each power unit has 1 plate. All telecom connectors sold separately.
- RJ45 (1) - \$55, RJ45 (2) - \$110, RJ45 (3) - \$165, USB (1) - \$70, USB (2) - \$140, RJ45/USB - \$125, RJ45/HDMI - \$210, HDMI/USB - \$205

Worksurface Height

- THL-42: Modify worksurface height to bar height - N/C



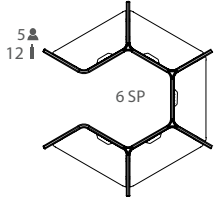

Number of Feet per Typical (MTL10 Option) "SP" Number of Starter Panels per Typical (RSP Option)

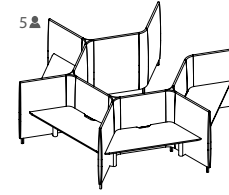

1 Select Model

w" x d" x h"	Weight	Standard Veneer Top Upholstered Panels - COM\$	Premium Veneer Top Upholstered Panels - COM\$
166 x 145 x 55	41	5 HNY166145HA583W 35880	"P" Option N/A

2 Select Finish

Click to view finishes

WWP	WOW
PO01	WNO
PO02	WSO
PO03	WNF(Natural Oak on Flat Cut)
PO07	WSF(Salted Oak on Flat Cut)
PO08	
PO09	
WBW	
WSW	
WEC	

3 Select Feet Finish

Click to view edges

WWP	WOW
PO01	WNO
PO02	WSO
PO03	
PO07	
PO08	
PO09	
WBW	
WSW	
WEC	

4 Select Edge

Click to view details

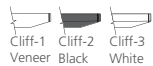

High Pressure Laminate Top Upholstered Panels - COM\$

HNY166145HA583G 34875

GEC	LW04
GNA +5%	LW05
GWL	LW06
LP01	
LF02	
LF03	
LN01	
LA02	
LW01	
LW02	

WWP	WOW
PO01	WNO
PO02	WSO
PO03	
PO07	
PO08	
PO09	
WBW	
WSW	
WEC	



Thermally Fused Laminate Top Upholstered Panels - COM\$

HNY166145HA583M 32965

MOC
MEC
MSW
MTW
MWL
MNA

WWP	WOW
PO01	WNO
PO02	WSO
PO03	
PO07	
PO08	
PO09	
WBW	
WSW	



Click here to view statement of line

Product Features

- 5" Solid wood feet - oval shape, ships KD
- 4 Power outlets with 1 telecom plate, see options below for telecom plate
- Adjustable height from 27" to 47.5" with a maximum weight capacity of 275 lbs. Lift standard in MFW White, optional MFB Black
- HNY7125WT163 Height Adjustable worksurfaces are included
- Wire management tray attaches to worksurface top, standard in MFW White, see premium Metal Finish for options
- T75 worksurface wire cutout is standard on all worksurfaces.(T75D: Delete cutout is optional)

Notes

- 1" Gap between worksurface and panels to drop wires below worksurface
- Metal parts include 5 year warranty
- Programmable height adjustable mechanism, motor includes 2 year warranty

Options

Accessories

- K28: Articulating Keyboard w/ Mouse - \$390
- K31-SK: Center drawer w/ skirt - \$310
- K31: Center drawer w/o skirt - \$205

Concealed Floor Power Infeed Cover

- PCEB: White Metal Finish concealed floor power infeed cover - \$150

Delete Top and Wire Tray

- DHAT: Delete height adjustable top. Deduct \$3845 Veneer(W), \$3644 High Pressure Laminate(G), \$3262 Thermally Fused Laminate(M) per top

Metal Feet

- MTL10: Replace solid wood feet with metal feet, standard MFW White - \$55 ea

Premium Metal Finish

- Specify premium Metal Finish. MFMB: Matte Black, MFS: Silver, MFSS: Salmon Sienna, MFSA: Surfing Aquavert, MFPS: Pistachio, MFOS: Oyster, MFNA: Navy, MFOL: Olive, MFGB: Grey Beige MFGG: Graphite Gray, MFG: Gray, MFGM:Matte Gold
- Premium Metal Finish for WMT Wire Management Tray - \$75 ea
- Premium Metal Finish for MTL10 Metal Feet - \$20 ea
- Premium Metal Finish for PCEB Concealed Floor Power Infeed Cover - \$35

Starter Panel

- RSP: Substitute round starter panel in place of flat starter panel. Must substitute all starters, priced per starter panel - \$83 each. See HNY3555SP888

Telecom Plates

- Each power unit has 1 plate. All telecom connectors sold separately.
- RJ45 (1) - \$55, RJ45 (2) - \$110, RJ45 (3) - \$165, USB (1) - \$70, USB (2) - \$140, RJ45/USB - \$125, RJ45/HDMI - \$210, HDMI/USB - \$205

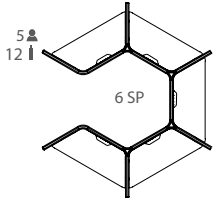

Number of Feet per Typical (MTL10 Option) "SP" Number of Starter Panels per Typical (RSP Option)

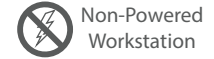
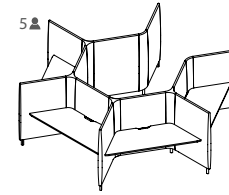

1 Select Model

w" x d" x h"  
166 x 145 x 55

Weight

41

Standard Veneer Top Upholstered Panels - COM\$  
5 HNY166145FT583W 22510

Premium Veneer Top Upholstered Panels - COM\$  
"P" Option N/A

High Pressure Laminate Top Upholstered Panels - COM\$  
HNY166145FT583G 21510

Thermally Fused Laminate Top Upholstered Panels - COM\$  
HNY166145FT583M 19600

[Click here to view statement of line](#)

Product Features

- 5" Solid wood feet - oval shape
- HNY7226WT162 Fixed Desk Height worksurfaces, 29" worksurface height
- Ships KD
- T75 worksurface wire cutout is standard on all worksurfaces.(T75D: Delete cutout is optional)

Options

Accessories

- K28: Articulating Keyboard w/ Mouse - \$390
- K31-SK: Center drawer w/ skirt - \$310
- K31: Center drawer w/o skirt - \$205

Concealed Floor Power Infeed Cover

- PCEB: White Metal Finish concealed floor power infeed cover - \$150

Delete Top

- DFT: Delete fixed top. Deduct \$1325 Veneer(W), \$1125 High Pressure Laminate (G), \$743 Thermally Fused Laminate (M) per top

Metal Feet

- MTL10: Replace solid wood feet with metal feet, standard MFW White - \$55 ea

Premium Metal Finish

- Specify premium Metal Finish. MFMB: Matte Black, MFS: Silver, MFSS: Salmon Sienna, MFSA: Surfing Aquavert, MFPS: Pistachio, MFOS: Oyster, MFNA: Navy, MFOL: Olive, MFGB: Grey Beige MFGG: Graphite Gray, MFG: Gray, MFGM:Matte Gold
- Premium Metal Finish for WMT Wire Management Tray - \$75 ea
- Premium Metal Finish for MTL10 Metal Feet - \$20 ea
- Premium Metal Finish for PCEB Concealed Floor Power Infeed Cover - \$35

Starter Panel

- RSP: Substitute round starter panel in place of flat starter panel. Must substitute all starters, priced per starter panel - \$83 each. See HNY3555SP888

Worksurface Height

- Modify worksurface height to bar height.
- THL-42: Position worksurface at bar height - N/C

Wire Tray

- WMT: Wire metal tray. Mounts under top and comes standard in MFW White - \$210

[Click Here for Graded in Pricing](#)

2 Select Finish

Click to view finishes

WWP	WOW
PO01	WNO
PO02	WSO
PO03	WNF(Natural Oak on Flat Cut)
PO07	WSF(Salted Oak on Flat Cut)
PO08	
PO09	
WBW	
WSW	
WEC	

3 Select Feet Finish

Click to view edges

WWP	WOW
PO01	WNO
PO02	WSO
PO03	
PO07	
PO08	
PO09	
WBW	
WSW	
WEC	

4 Select Edge

Click to view details



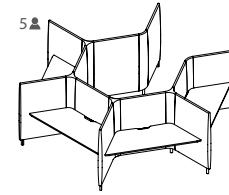
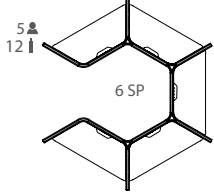

Fixed Top Workstation

Powered Workstation

Number of Feet per Typical (MTL10 Option) "SP" Number of Starter Panels per Typical (RSP Option)

1 Select Model

Weight	Standard Veneer Top Upholstered Panels - COM\$	Premium Veneer Top Upholstered Panels - COM\$	High Pressure Laminate Top Upholstered Panels - COM\$	Thermally Fused Laminate Top Upholstered Panels - COM\$
w" x d" x h"				
166 x 145 x 55	41	5 HNY166145FP583W 24425	"P" Option N/A	HNY166145FP583M 21515

[Click Here for Graded in Pricing](#)

2 Select Finish

Click to view finishes

WWP	WOW
PO01	WNO
PO02	WSO
PO03	WNF(Natural Oak on Flat Cut)
PO07	WSF(Salted Oak on Flat Cut)
PO08	
PO09	
WBW	
WSW	
WEC	

3 Select Feet Finish

Click to view edges

WWP	WOW
PO01	WNO
PO02	WSO
PO03	
PO07	
PO08	
PO09	
WBW	
WSW	
WEC	

4 Select Edge

Click to view details

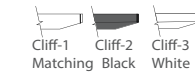
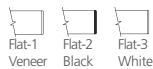

[Click here to view statement of line](#)

Product Features

- HNY7226WT162 Fixed Desk Height worksurfaces, 29" worksurface height
- 5" Solid wood feet - oval shape
- 4 Power outlets with 1 telecom plate, see options below for telecom plate
- Ships KD
- Wire management tray attaches to worksurface top, standard in MFW White, see premium Metal Finish for options
- Hardwire infeed and jumpers are included in workstations
- T75 worksurface wire cutout is standard on all worksurfaces.(T75D: Delete cutout is optional)

Options

Accessories

- K28: Articulating Keyboard w/ Mouse - \$390
- K31-SK: Center drawer w/ skirt - \$310
- K31: Center drawer w/o skirt - \$205

Concealed Floor Power Infeed Cover

- PCEB: White Metal Finish concealed floor power infeed cover - \$150

Delete Top and Wire Tray

- DFP: Delete fixed top. Deduct \$1535 Veneer (W), \$1335 High Pressure Laminate (G), \$953 Thermally Fused Laminate (M) per top

Metal Feet

- MTL10: Replace solid wood feet with metal feet, standard MFW White - \$55 ea

Premium Metal Finish

- Specify premium Metal Finish. MFMB: Matte Black, MFS: Silver, MFSS: Salmon Sienna, MFSA: Surfing Aquavert, MFPS: Pistachio, MFOS: Oyster, MFNA: Navy, MFOL: Olive, MFGB: Grey Beige MFGG: Graphite Gray, MFG: Gray, MFGM:Matte Gold
- Premium Metal Finish for WMT Wire Management Tray - \$75 ea
- Premium Metal Finish for MTL10 Metal Feet - \$20 ea
- Premium Metal Finish for PCEB Concealed Floor Power Infeed Cover - \$35

Starter Panel

- RSP: Substitute round starter panel in place of flat starter panel. Must substitute all starters, priced per starter panel - \$83 each. See HNY3555SP888

Telecom Plates

- Each power unit has 1 plate. All telecom connectors sold separately.
- RJ45 (1) - \$55, RJ45 (2) - \$110, RJ45 (3) - \$165, USB (1) - \$70, USB (2) - \$140, RJ45/USB - \$125, RJ45/HDMI - \$210, HDMI/USB - \$205

Worksurface Height

- THL-42: Modify worksurface height to bar height - N/C

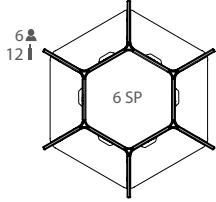

Number of Feet per Typical (MTL10 Option) "SP" Number of Starter Panels per Typical (RSP Option)

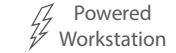
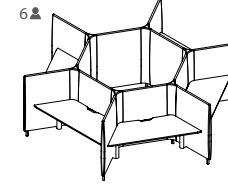

1 Select Model

Weight	Standard Veneer Top Upholstered Panels - COM\$
166 x 145 x 55	45 6 HNY166145HA584W 41323

Premium Veneer Top Upholstered Panels - COM\$
"P" Option N/A

High Pressure Laminate Top Upholstered Panels - COM\$
HNY166145HA584G 40117

Thermally Fused Laminate Top Upholstered Panels - COM\$
HNY166145HA584M 37825

[Click here to view statement of line](#)

Product Features

- 5" Solid wood feet - oval shape, ships KD
- 4 Power outlets with 1 telecom plate, see options below for telecom plate
- Adjustable height from 27" to 47.5" with a maximum weight capacity of 275 lbs. Lift standard in MFW White, optional MFB Black
- HNY7125WT163 Height Adjustable worksurfaces are included
- Wire management tray attaches to worksurface top, standard in MFW White, see premium Metal Finish for options
- T75 worksurface wire cutout is standard on all worksurfaces.(T75D: Delete cutout is optional)

Notes

- 1" Gap between worksurface and panels to drop wires below worksurface
- Metal parts include 5 year warranty
- Programmable height adjustable mechanism, motor includes 2 year warranty

Options

Accessories

- K28: Articulating Keyboard w/ Mouse - \$390
- K31-SK: Center drawer w/ skirt - \$310
- K31: Center drawer w/o skirt - \$205

Concealed Floor Power Infeed Cover

- PCEB: White Metal Finish concealed floor power infeed cover - \$150

Delete Top and Wire Tray

- DHAT: Delete height adjustable top. Deduct \$3845 Veneer(W), \$3644 High Pressure Laminate(G), \$3262 Thermally Fused Laminate(M) per top

Metal Feet

- MTL10: Replace solid wood feet with metal feet, standard MFW White - \$55 ea

Premium Metal Finish

- Specify premium Metal Finish. MFMB: Matte Black, MFS: Silver, MFSS: Salmon Sienna, MFSA: Surfing Aquavert, MFPS: Pistachio, MFOS: Oyster, MFNA: Navy, MFOL: Olive, MFGB: Grey Beige MFGG: Graphite Gray, MFG: Gray, MFGM:Matte Gold
- Premium Metal Finish for WMT Wire Management Tray - \$75 ea
- Premium Metal Finish for MTL10 Metal Feet - \$20 ea
- Premium Metal Finish for PCEB Concealed Floor Power Infeed Cover - \$35

Starter Panel

- RSP: Substitute round starter panel in place of flat starter panel. Must substitute all starters, priced per starter panel - \$83 each. See HNY3555SP888

Telecom Plates

- Each power unit has 1 plate. All telecom connectors sold separately.
- RJ45 (1) - \$55, RJ45 (2) - \$110, RJ45 (3) - \$165, USB (1) - \$70, USB (2) - \$140, RJ45/USB - \$125, RJ45/HDMI - \$210, HDMI/USB - \$205

[Click Here for Graded in Pricing](#)

2 Select Finish

Click to view finishes

WWP	WOW
PO01	WNO
PO02	WSO
PO03	WNF(Natural Oak on Flat Cut)
PO07	WSF(Salted Oak on Flat Cut)
PO08	
PO09	
WBW	
WSW	
WEC	

3 Select Feet Finish

Click to view edges

WWP	WOW
PO01	WNO
PO02	WSO
PO03	
PO07	
PO08	
PO09	
WBW	
WSW	
WEC	

4 Select Edge

Click to view details

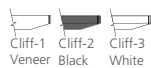

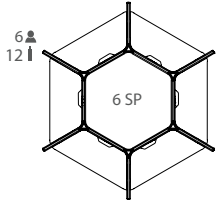

Number of Feet per Typical (MTL10 Option) "SP" Number of Starter Panels per Typical (RSP Option)

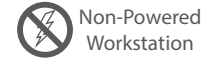
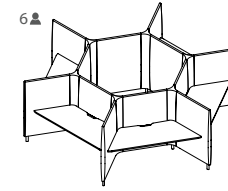

1 Select Model

Weight	Standard Veneer Top Upholstered Panels - COM\$
w" x d" x h"	6 SP
166 x 145 x 55	45 6 HNY166145FT584W 25320

2 Select Finish

Click to view finishes

WWP	WOW
PO01	WNO
PO02	WSO
PO03	WNF(Natural Oak on Flat Cut)
PO07	WSF(Salted Oak on Flat Cut)
PO08	
PO09	
WBW	
WSW	
WEC	

3 Select Feet Finish

Click to view edges

WWP	WOW
PO01	WNO
PO02	WSO
PO03	
PO07	
PO08	
PO09	
WBW	
WSW	
WEC	

4 Select Edge

Click to view details



Premium Veneer Top Upholstered Panels - COM\$

"P" Option N/A

High Pressure Laminate Top Upholstered Panels - COM\$

HNY166145FT584G 24120

GEC	LW04
GNA +5%	LW05
GWL	LW06
LP01	
LF02	
LF03	
LN01	
LA02	
LW01	
LW02	

WWP	WOW
PO01	WNO
PO02	WSO
PO03	
PO07	
PO08	
PO09	
WBW	
WSW	
WEC	



Thermally Fused Laminate Top Upholstered Panels - COM\$

HNY166145FT584M 21828

MOC
MEC
MSW
MTW
MWL
MNA

WWP	WOW
PO01	WNO
PO02	WSO
PO03	
PO07	
PO08	
PO09	
WBW	
WSW	



Click here to view statement of line

Product Features

- 5" Solid wood feet - oval shape
- HNY7226WT162 Fixed Desk Height worksurfaces, 29" worksurface height
- Ships KD
- T75 worksurface wire cutout is standard on all worksurfaces.(T75D: Delete cutout is optional)

Options

Accessories

- K28: Articulating Keyboard w/ Mouse - \$390
- K31-SK: Center drawer w/ skirt - \$310
- K31: Center drawer w/o skirt - \$205

Concealed Floor Power Infeed Cover

- PCEB: White Metal Finish concealed floor power infeed cover - \$150

Delete Top

- DFT: Delete fixed top. Deduct \$1325 Veneer(W), \$1125 High Pressure Laminate (G), \$743 Thermally Fused Laminate (M) per top

Metal Feet

- MTL10: Replace solid wood feet with metal feet, standard MFW White - \$55 ea

Premium Metal Finish

- Specify premium Metal Finish. MFMB: Matte Black, MFS: Silver, MFSS: Salmon Sienna, MFSA: Surfin Aquavert, MFPS: Pistachio, MFOS: Oyster, MFNA: Navy, MFOL: Olive, MFGB: Grey Beige MFGG: Graphite Gray, MFG: Gray, MFGM:Matte Gold
- Premium Metal Finish for WMT Wire Management Tray - \$75 ea
- Premium Metal Finish for MTL10 Metal Feet - \$20 ea
- Premium Metal Finish for PCEB Concealed Floor Power Infeed Cover - \$35

Starter Panel

- RSP: Substitute round starter panel in place of flat starter panel. Must substitute all starters, priced per starter panel - \$83 each. See HNY3555SP888

Worksurface Height

- Modify worksurface height to bar height.
- THL-42: Position worksurface at bar height - N/C

Wire Tray

- WMT: Wire metal tray. Mounts under top and comes standard in MFW White - \$210

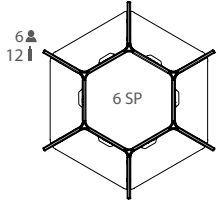

Number of Feet per Typical (MTL10 Option) "SP" Number of Starter Panels per Typical (RSP Option)

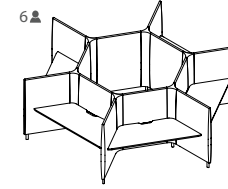

Fixed Top Workstation

Powered Workstation

1 Select Model

Weight	Standard Veneer Top Upholstered Panels - COM\$
w" x d" x h"	6 HNY166145FP584W 27577
166 x 145 x 55	45

Premium Veneer Top Upholstered Panels - COM\$

"P" Option N/A

High Pressure Laminate Top Upholstered Panels - COM\$

HNY166145FP584G 26377

Thermally Fused Laminate Top Upholstered Panels - COM\$

HNY166145FP584M 24085

[Click here to view statement of line](#)

Product Features

- HNY7226WT162 Fixed Desk Height worksurfaces, 29" worksurface height
- 5" Solid wood feet - oval shape
- 4 Power outlets with 1 telecom plate, see options below for telecom plate
- Ships KD
- Wire management tray attaches to worksurface top, standard in MFW White, see premium Metal Finish for options
- Hardwire infeed and jumpers are included in workstations
- T75 worksurface wire cutout is standard on all worksurfaces.(T75D: Delete cutout is optional)

[Click Here for Graded in Pricing](#)

2 Select Finish

Click to view finishes

WWP	WOW
PO01	WNO
PO02	WSO
PO03	WNF(Natural Oak on Flat Cut)
PO07	WSF(Salted Oak on Flat Cut)
PO08	
PO09	
WBW	
WSW	
WEC	

GEC	LW04
GNA +5%	LW05
GWL	LW06
LP01	
LF02	
LF03	
LN01	
LA02	
LW01	
LW02	

MOC
MEC
MSW
MTW
MWL
MNA

3 Select Feet Finish

Click to view edges

WWP	WOW
PO01	WNO
PO02	WSO
PO03	
PO07	
PO08	
PO09	
WBW	
WSW	
WEC	

WWP	WOW
PO01	WNO
PO02	WSO
PO03	
PO07	
PO08	
PO09	
WBW	
WSW	
WEC	

WWP	WOW
PO01	WNO
PO02	WSO
PO03	
PO07	
PO08	
PO09	
WEC	
WBW	
WSW	

4 Select Edge

Click to view details



Options

Accessories

- K28: Articulating Keyboard w/ Mouse - \$390
- K31-SK: Center drawer w/ skirt - \$310
- K31: Center drawer w/o skirt - \$205

Concealed Floor Power Infeed Cover

- PCEB: White Metal Finish concealed floor power infeed cover - \$150

Delete Top and Wire Tray

- DFP: Delete fixed top. Deduct \$1535 Veneer (W), \$1335 High Pressure Laminate (G), \$953 Thermally Fused Laminate (M) per top

Metal Feet

- MTL10: Replace solid wood feet with metal feet, standard MFW White - \$55 ea

Premium Metal Finish

- Specify premium Metal Finish. MFMB: Matte Black, MFS: Silver, MFSS: Salmon Sienna, MFSA: Surfing Aquavert, MFPS: Pistachio, MFOS: Oyster, MFNA: Navy, MFOL: Olive, MFGB: Grey Beige MFGG: Graphite Gray, MFG: Gray, MFGM:Matte Gold

- Premium Metal Finish for WMT Wire Management Tray - \$75 ea
- Premium Metal Finish for MTL10 Metal Feet - \$20 ea
- Premium Metal Finish for PCEB Concealed Floor Power Infeed Cover - \$35

Starter Panel

- RSP: Substitute round starter panel in place of flat starter panel. Must substitute all starters, priced per starter panel - \$83 each. See HNY3555SP888

Telecom Plates

- Each power unit has 1 plate. All telecom connectors sold separately.
- RJ45 (1) - \$55, RJ45 (2) - \$110, RJ45 (3) - \$165, USB (1) - \$70, USB (2) - \$140, RJ45/USB - \$125, RJ45/HDMI - \$210, HDMI/USB - \$205

Worksurface Height

- THL-42: Modify worksurface height to bar height - N/C

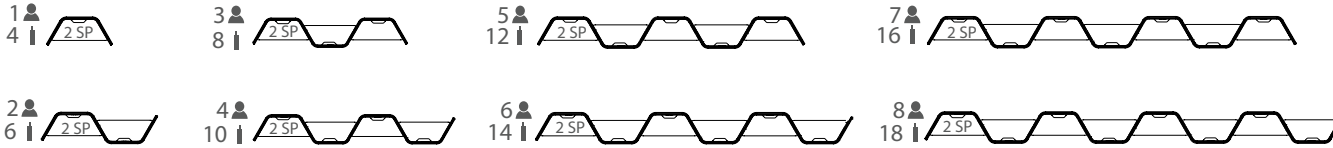

Number of Feet per Typical (MTL10 Option) "SP" Number of Starter Panels per Typical (RSP Option)

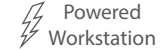
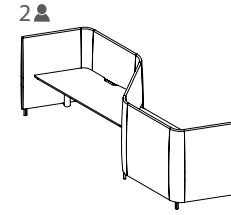

1 Select Model

w" x d" x h"	Weight	Standard Veneer Top Upholstered Panels - COM\$	Premium Veneer Top Upholstered Panels - COM\$	High Pressure Laminate Top Upholstered Panels - COM\$	Thermally Fused Laminate Top Upholstered Panels - COM\$
539 x 41 x 55	67	8 HNY53941HA585W 60828	"P" Option N/A	HNY53941HA585G 59220	HNY53941HA585M 56164
474 x 41 x 55	59	7 HNY47441HA585W 53348	"P" Option N/A	HNY47441HA585G 51941	HNY47441HA585M 49267
409 x 41 x 55	51	6 HNY40941HA585W 45868	"P" Option N/A	HNY40941HA585G 44662	HNY40941HA585M 42370
345 x 41 x 55	43	5 HNY34541HA585W 38388	"P" Option N/A	HNY34541HA585G 37383	HNY34541HA585M 35473
280 x 41 x 55	35	4 HNY28041HA585W 30908	"P" Option N/A	HNY28041HA585G 30104	HNY28041HA585M 28576
215 x 41 x 55	27	3 HNY21541HA585W 23428	"P" Option N/A	HNY21541HA585G 22825	HNY21541HA585M 21679
150 x 41 x 55	19	2 HNY15041HA585W 15948	"P" Option N/A	HNY15041HA585G 15546	HNY15041HA585M 14782
85 x 37 x 55	11	1 HNY8537HA585W 8468	"P" Option N/A	HNY8537HA585G 8267	HNY8537HA585M 7885

[Click Here for Graded in Pricing](#)

2 Select Finish

Click to view finishes

WWP	WOW
PO01	WNO
PO02	WSO
PO03	WNF(Natural Oak on Flat Cut)
PO07	WSF(Salted Oak on Flat Cut)
PO08	WSF(Salted Oak on Flat Cut)
PO09	WSF(Salted Oak on Flat Cut)
WBW	
WSW	
WEC	

3 Select Feet Finish

Click to view edges

WWP	WOW
PO01	WNO
PO02	WSO
PO03	
PO07	
PO08	
PO09	
WBW	
WSW	
WEC	

4 Select Edge

Click to view details



[Click here to view statement of line](#)

Product Features

- 5" Solid wood feet - oval shape, ships KD
- 4 Power outlets with 1 telecom plate, see options below for telecom plate
- Adjustable height from 27" to 47.5" with a maximum weight capacity of 275 lbs.
- Lift standard in MFW White, optional MFB Black
- HNY7125WT163 Height Adjustable worksurfaces are included
- Wire management tray attaches to worksurface top, standard in MFW White, see premium Metal Finish for options
- T75 worksurface wire cutout is standard on all worksurfaces.(T75D: Delete cutout is optional)

Notes

- 1" Gap between worksurface and panels to drop wires below worksurface
- Metal parts include 5 year warranty
- Programmable height adjustable mechanism, motor includes 2 year warranty

Options

Accessories

- K28: Articulating Keyboard w/ Mouse - \$390
- K31-SK: Center drawer w/ skirt - \$310
- K31: Center drawer w/o skirt - \$205

Concealed Floor Power Infeed Cover

- PCEB: White Metal Finish concealed floor power infeed cover - \$150

Delete Top and Wire Tray

- DHAT: Delete height adjustable top. Deduct \$3845 Veneer(W), \$3644 High Pressure Laminate(G), \$3262 Thermally Fused Laminate(M) per top

Metal Feet

- MTL10: Replace solid wood feet with metal feet, standard MFW White - \$55 ea

Premium Metal Finish

- Specify premium Metal Finish. MFMB: Matte Black, MFS: Silver, MFSS: Salmon Sienna, MFSA: Surfin Aquavert, MFPS: Pistachio, MFOS: Oyster, MFNA: Navy, MFOL: Olive, MFGB: Grey Beige MFGG: Graphite Gray, MFG: Gray, MFGM:Matte Gold
- Premium Metal Finish for WMT Wire Management Tray - \$75 ea
- Premium Metal Finish for MTL10 Metal Feet - \$20 ea
- Premium Metal Finish for PCEB Concealed Floor Power Infeed Cover - \$35

Starter Panel

- RSP: Substitute round starter panel in place of flat starter panel. Must substitute all starters, priced per starter panel - \$83 each. See HNY3555SP888

Telecom Plates

- Each power unit has 1 plate. All telecom connectors sold separately.
- RJ45 (1) - \$55, RJ45 (2) - \$110, RJ45 (3) - \$165, USB (1) - \$70, USB (2) - \$140, RJ45/USB - \$125, RJ45/HDMI - \$210, HDMI/USB - \$205

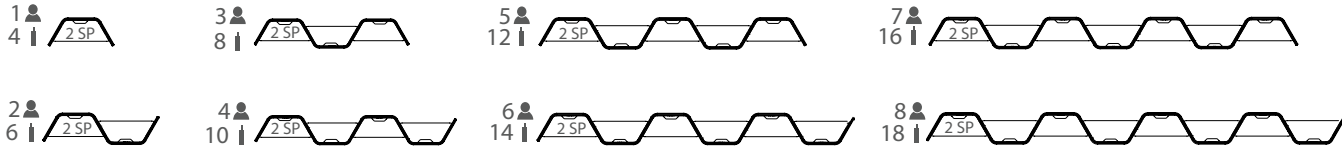

Number of Feet per Typical (MTL10 Option) "SP" Number of Starter Panels per Typical (RSP Option)

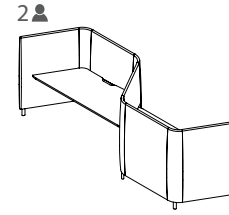

1 Select Model

w" x d" x h"	Weight	Standard Veneer Top Upholstered Panels - COM\$	Premium Veneer Top Upholstered Panels - COM\$	High Pressure Laminate Top Upholstered Panels - COM\$	Thermally Fused Laminate Top Upholstered Panels - COM\$
539 x 41 x 55	67	8 HNY53941FT585W 38656	"P" Option N/A	HNY53941FT585G 37056	HNY53941FT585M 34000
474 x 41 x 55	59	7 HNY47441FT585W 33938	"P" Option N/A	HNY47441FT585G 32538	HNY47441FT585M 29864
409 x 41 x 55	51	6 HNY40941FT585W 29220	"P" Option N/A	HNY40941FT585G 28020	HNY40941FT585M 25728
345 x 41 x 55	43	5 HNY34541FT585W 24502	"P" Option N/A	HNY34541FT585G 23502	HNY34541FT585M 21592
280 x 41 x 55	35	4 HNY28041FT585W 19784	"P" Option N/A	HNY28041FT585G 18984	HNY28041FT585M 17456
215 x 41 x 55	27	3 HNY21541FT585W 15066	"P" Option N/A	HNY21541FT585G 14466	HNY21541FT585M 13320
150 x 41 x 55	19	2 HNY15041FT585W 10348	"P" Option N/A	HNY15041FT585G 9948	HNY15041FT585M 9184
85 x 37 x 55	11	1 HNY8537FT585W 5630	"P" Option N/A	HNY8537FT585G 5430	HNY8537FT585M 5048

[Click Here for Graded in Pricing](#)

2 Select Finish

Click to view finishes

WWP	WOW
PO01	WNO
PO02	WSO
PO03	WNF(Natural Oak on Flat Cut)
PO07	WSF(Salted Oak on Flat Cut)
PO08	WSF(Salted Oak on Flat Cut)
PO09	WSF(Salted Oak on Flat Cut)
WBW	
WSW	
WEC	

3 Select Feet Finish

Click to view edges

WWP	WOW
PO01	WNO
PO02	WSO
PO03	
PO07	
PO08	
PO09	
WBW	
WSW	
WEC	

4 Select Edge

Click to view details



GEC	LW04
GNA +5%	LW05
GWL	LW06
LP01	
LF02	
LF03	
LN01	
LA02	
LW01	
LW02	

WWP	WOW
PO01	WNO
PO02	WSO
PO03	
PO07	
PO08	
PO09	
WBW	
WSW	
WEC	

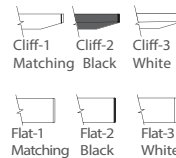

MOC
MEC
MSW
MTW
MWL
MNA

WWP	WOW
PO01	WNO
PO02	WSO
PO03	
PO07	
PO08	
PO09	
WBW	
WSW	



[Click here to view statement of line](#)

Product Features

- 5" Solid wood feet - oval shape
- HNY7226WT162 Fixed Desk Height worksurfaces, 29" worksurface height
- Ships KD
- T75 worksurface wire cutout is standard on all worksurfaces.(T75D: Delete cutout is optional)

Options

Accessories

- K28: Articulating Keyboard w/ Mouse - \$390
- K31-SK: Center drawer w/ skirt - \$310
- K31: Center drawer w/o skirt - \$205

Concealed Floor Power Infeed Cover

- PCEB: White Metal Finish concealed floor power infeed cover - \$150

Delete Top

- DFT: Delete fixed top. Deduct \$1325 Veneer(W), \$1125 High Pressure Laminate (G), \$743 Thermally Fused Laminate (M) per top

Metal Feet

- MTL10: Replace solid wood feet with metal feet, standard MFW White - \$55 ea

Premium Metal Finish

- Specify premium Metal Finish. MFMB: Matte Black, MFS: Silver, MFSS: Salmon Sienna, MFSA: Surfing Aquavert, MFPS: Pistachio, MFOS: Oyster, MFNA: Navy, MFOL: Olive, MFGB: Grey Beige MFGG: Graphite Gray, MFG: Gray, MFGM:Matte Gold
- Premium Metal Finish for WMT Wire Management Tray - \$75 ea
- Premium Metal Finish for MTL10 Metal Feet - \$20 ea
- Premium Metal Finish for PCEB Concealed Floor Power Infeed Cover - \$35

Starter Panel

- RSP: Substitute round starter panel in place of flat starter panel. Must substitute all starters, priced per starter panel - \$83 each. See HNY3555SP888

Worksurface Height

- Modify worksurface height to bar height.
- THL-42: Position worksurface at bar height - N/C

Wire Tray

- WMT: Wire metal tray. Mounts under top and comes standard in MFW White - \$210



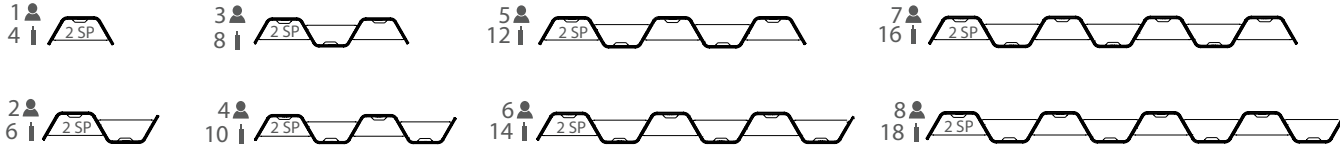

Number of Feet per Typical (MTL10 Option) "SP" Number of Starter Panels per Typical (RSP Option)

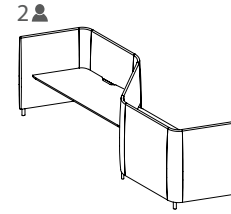

Fixed Top Workstation

Powered Workstation

1 Select Model

w" x d" x h"	Weight	Standard Veneer Top Upholstered Panels - COM\$	Premium Veneer Top Upholstered Panels - COM\$	High Pressure Laminate Top Upholstered Panels - COM\$	Thermally Fused Laminate Top Upholstered Panels - COM\$
539 x 41 x 55	67	8 HNY53941FP585W 42500	"P" Option N/A	HNY53941FP585G 40900	HNY53941FP585M 37844
474 x 41 x 55	59	7 HNY47441FP585W 37311	"P" Option N/A	HNY47441FP585G 35911	HNY47441FP585M 33237
409 x 41 x 55	51	6 HNY40941FP585W 32122	"P" Option N/A	HNY40941FP585G 30922	HNY40941FP585M 28630
345 x 41 x 55	43	5 HNY34541FP585W 26933	"P" Option N/A	HNY34541FP585G 25933	HNY34541FP585M 24023
280 x 41 x 55	35	4 HNY28041FP585W 21744	"P" Option N/A	HNY28041FP585G 20944	HNY28041FP585M 19416
215 x 41 x 55	27	3 HNY21541FP585W 16555	"P" Option N/A	HNY21541FP585G 15955	HNY21541FP585M 14809
150 x 41 x 55	19	2 HNY15041FP585W 11366	"P" Option N/A	HNY15041FP585G 10966	HNY15041FP585M 10202
85 x 37 x 55	11	1 HNY8537FP585W 6177	"P" Option N/A	HNY8537FP585G 5977	HNY8537FP585M 5595

[Click Here for Graded in Pricing](#)

2 Select Finish

Click to view finishes

WWP	WOW
PO01	WNO
PO02	WSO
PO03	WNF(Natural Oak on Flat Cut)
PO07	WSF(Salted Oak on Flat Cut)
PO08	WSF(Salted Oak on Flat Cut)
PO09	WSF(Salted Oak on Flat Cut)
WBW	
WSW	
WEC	

3 Select Feet Finish

Click to view edges

WWP	WOW
PO01	WNO
PO02	WSO
PO03	
PO07	
PO08	
PO09	
WBW	
WSW	
WEC	

4 Select Edge

Click to view details



GEC	LW04
GNA +5%	LW05
GWL	LW06
LP01	
LF02	
LF03	
LN01	
LA02	
LW01	
LW02	

WWP	WOW
PO01	WNO
PO02	WSO
PO03	
PO07	
PO08	
PO09	
WBW	
WSW	
WEC	



MOC
MEC
MSW
MTW
MWL
MNA

WWP	WOW
PO01	WNO
PO02	WSO
PO03	
PO07	
PO08	
PO09	
WEC	
WBW	
WSW	



[Click here to view statement of line](#)

Product Features

- HNY7226WT162 Fixed Desk Height worksurfaces, 29" worksurface height
- 5" Solid wood feet - oval shape
- 4 Power outlets with 1 telecom plate, see options below for telecom plate
- Ships KD
- Wire management tray attaches to worksurface top, standard in MFW White, see premium Metal Finish for options
- Hardwire infeed and jumpers are included in workstations
- T75 worksurface wire cutout is standard on all worksurfaces.(T75D: Delete cutout is optional)

Options

Accessories

- K28: Articulating Keyboard w/ Mouse - \$390
- K31-SK: Center drawer w/ skirt - \$310
- K31: Center drawer w/o skirt - \$205

Concealed Floor Power Infeed Cover

- PCEB: White Metal Finish concealed floor power infeed cover - \$150

Delete Top and Wire Tray

- DFP: Delete fixed top. Deduct \$1535 Veneer (W), \$1335 High Pressure Laminate (G), \$953 Thermally Fused Laminate (M) per top

Metal Feet

- MTL10: Replace solid wood feet with metal feet, standard MFW White - \$55 ea

Premium Metal Finish

- Specify premium Metal Finish. MFMB: Matte Black, MFS: Silver, MFSS: Salmon Sienna, MFSA: Surfing Aquavert, MFPS: Pistachio, MFOS: Oyster, MFNA: Navy, MFOL: Olive, MFGB: Grey Beige MFGG: Graphite Gray, MFG: Gray, MFGM:Matte Gold
- Premium Metal Finish for WMT Wire Management Tray - \$75 ea
- Premium Metal Finish for MTL10 Metal Feet - \$20 ea
- Premium Metal Finish for PCEB Concealed Floor Power Infeed Cover - \$35

Starter Panel

- RSP: Substitute round starter panel in place of flat starter panel. Must substitute all starters, priced per starter panel - \$83 each. See HNY3555SP888

Telecom Plates

- Each power unit has 1 plate. All telecom connectors sold separately.
- RJ45 (1) - \$55, RJ45 (2) - \$110, RJ45 (3) - \$165, USB (1) - \$70, USB (2) - \$140, RJ45/USB - \$125, RJ45/HDMI - \$210, HDMI/USB - \$205

Worksurface Height

- THL-42: Modify worksurface height to bar height - N/C

DARRAN

Honey

S-Shaped Workstation Typical  
Desk with Height Adjustable Worksurface

5  
12

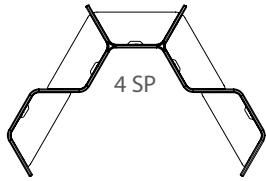

4 SP

8  
18



6 SP

8

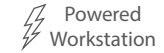
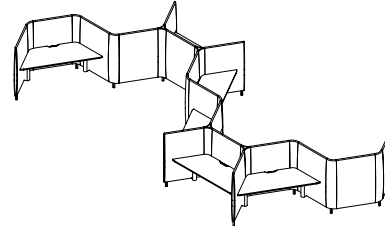

Number of Feet per Typical (MTL10 Option) "SP" Number of Starter Panels per Typical (RSP Option)

1 Select Model

Weight

Standard Veneer Top Upholstered Panels - COM\$

Premium Veneer Top Upholstered Panels - COM\$

High Pressure Laminate Top Upholstered Panels - COM\$

Thermally Fused Laminate Top Upholstered Panels - COM\$

w" x d" x h"	Weight	8	5
347 x 145 x 55	65	HNY347145HA586W 58320	HNY217145HA586W 37134
217 x 145 x 55	42		

"P" Option N/A  
"P" Option N/A

HNY347145HA586G	56712
HNY217145HA586G	36129

HNY347145HA586M	53656
HNY217145HA586M	34219

[Click here to view statement of line](#)

Product Features

- 5" Solid wood feet - oval shape, ships KD
- 4 Power outlets with 1 telecom plate, see options below for telecom plate
- Adjustable height from 27" to 47.5" with a maximum weight capacity of 275 lbs. Lift standard in MFW White, optional MFB Black
- HNY7125WT163 Height Adjustable worksurfaces are included
- Wire management tray attaches to worksurface top, standard in MFW White, see premium Metal Finish for options
- T75 worksurface wire cutout is standard on all worksurfaces.(T75D: Delete cutout is optional)

Notes

- 1" Gap between worksurface and panels to drop wires below worksurface
- Metal parts include 5 year warranty
- Programmable height adjustable mechanism, motor includes 2 year warranty

Options

Accessories

- K28: Articulating Keyboard w/ Mouse - \$390
- K31-SK: Center drawer w/ skirt - \$310
- K31: Center drawer w/o skirt - \$205

Concealed Floor Power Infeed Cover

- PCEB: White Metal Finish concealed floor power infeed cover - \$150

Delete Top and Wire Tray

- DHAT: Delete height adjustable top. Deduct \$3845 Veneer(W), \$3644 High Pressure Laminate(G), \$3262 Thermally Fused Laminate(M) per top

Metal Feet

- MTL10: Replace solid wood feet with metal feet, standard MFW White - \$55 ea

Premium Metal Finish

- Specify premium Metal Finish. MFMB: Matte Black, MFS: Silver, MFSS: Salmon Sienna, MFSA: Surfing Aquavert, MFPS: Pistachio, MFOS: Oyster, MFNA: Navy, MFOL: Olive, MFGB: Grey Beige MFGG: Graphite Gray, MFG: Gray, MFGM:Matte Gold
- Premium Metal Finish for WMT Wire Management Tray - \$75 ea
- Premium Metal Finish for MTL10 Metal Feet - \$20 ea
- Premium Metal Finish for PCEB Concealed Floor Power Infeed Cover - \$35

Starter Panel

- RSP: Substitute round starter panel in place of flat starter panel. Must substitute all starters, priced per starter panel - \$83 each. See HNY3555SP888

Telecom Plates

- Each power unit has 1 plate. All telecom connectors sold separately.
- RJ45 (1) - \$55, RJ45 (2) - \$110, RJ45 (3) - \$165, USB (1) - \$70, USB (2) - \$140, RJ45/USB - \$125, RJ45/HDMI - \$210, HDMI/USB - \$205

[Click Here for Graded in Pricing](#)

2 Select Finish

Click to view finishes

WWP	WOW
PO01	WNO
PO02	WSO
PO03	WNF(Natural Oak on Flat Cut)
PO07	WSF(Salted Oak on Flat Cut)
PO08	
PO09	
WBW	
WSW	
WEC	

3 Select Feet Finish

Click to view edges

WWP	WOW
PO01	WNO
PO02	WSO
PO03	
PO07	
PO08	
PO09	
WBW	
WSW	
WEC	

4 Select Edge

Click to view details

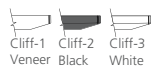

GEC	LW04
GNA +5%	LW05
GWL	LW06
LP01	
LF02	
LF03	
LN01	
LA02	
LW01	
LW02	

WWP	WOW
PO01	WNO
PO02	WSO
PO03	
PO07	
PO08	
PO09	
WBW	
WSW	
WEC	



MOC
MEC
MSW
MTW
MWL
MNA

WWP	WOW
PO01	WNO
PO02	WSO
PO03	
PO07	
PO08	
PO09	
WEC	
WBW	
WSW	



**DARRAN**

**Honey**

S-Shaped Workstation Typical  
Desk with Fixed Worksurface

5  
12

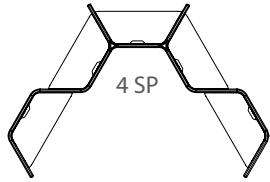

4 SP

8  
18



6 SP

8

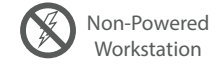
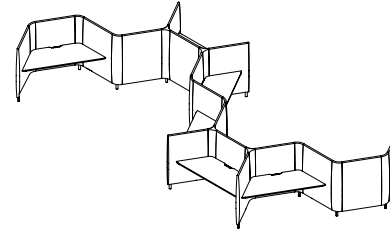

Number of Feet per Typical (MTL10 Option) "SP" Number of Starter Panels per Typical (RSP Option)

**1 Select Model**

Weight

Standard Veneer Top  
Upholstered Panels - COM\$

Premium Veneer Top  
Upholstered Panels - COM\$

High Pressure Laminate Top  
Upholstered Panels - COM\$

Thermally Fused Laminate Top  
Upholstered Panels - COM\$

w" x d" x h"	Weight	8	5
347 x 145 x 55	65	8 HNY347145FT586W 36664	5 HNY217145FT586W 23506
217 x 145 x 55	42		

"P" Option N/A  
"P" Option N/A

HNY347145FT586G 35064  
HNY217145FT586G 22506

HNY347145FT586M 32008  
HNY217145FT586M 20596

**Product Features**

- 5" Solid wood feet - oval shape
- HNY7226WT162 Fixed Desk Height worksurfaces, 29" worksurface height
- Ships KD
- T75 worksurface wire cutout is standard on all worksurfaces.(T75D: Delete cutout is optional)

**Options**

**Accessories**

- K28: Articulating Keyboard w/ Mouse - \$390
- K31-SK: Center drawer w/ skirt - \$310
- K31: Center drawer w/o skirt - \$205

**Concealed Floor Power Infeed Cover**

- PCEB: White Metal Finish concealed floor power infeed cover - \$150

**Delete Top**

- DFT: Delete fixed top. Deduct \$1325 Veneer(W), \$1125 High Pressure Laminate (G), \$743 Thermally Fused Laminate (M) per top

**Metal Feet**

- MTL10: Replace solid wood feet with metal feet, standard MFW White - \$55 ea

**Premium Metal Finish**

- Specify premium Metal Finish. MFMB: Matte Black, MFS: Silver, MFSS: Salmon Sienna, MFSA: Surfing Aquavert, MFPS: Pistachio, MFOS: Oyster, MFNA: Navy, MFOL: Olive, MFGB: Grey Beige MFGG: Graphite Gray, MFG: Gray, MFGM:Matte Gold
- Premium Metal Finish for WMT Wire Management Tray - \$75 ea
- Premium Metal Finish for MTL10 Metal Feet - \$20 ea
- Premium Metal Finish for PCEB Concealed Floor Power Infeed Cover - \$35

**Starter Panel**

- RSP: Substitute round starter panel in place of flat starter panel. Must substitute all starters, priced per starter panel - \$83 each. See HNY3555SP888

**Worksurface Height**

- Modify worksurface height to bar height.
- THL-42: Position worksurface at bar height - N/C

**Wire Tray**

- WMT: Wire metal tray. Mounts under top and comes standard in MFW White - \$210

[Click Here for Graded in Pricing](#)

**2 Select Finish**

Click to view finishes

WWP	WOW
PO01	WNO
PO02	WSO
PO03	WNF(Natural Oak on Flat Cut)
PO07	WSF(Salted Oak on Flat Cut)
PO08	
PO09	
WBW	
WSW	
WEC	

**3 Select Feet Finish**

Click to view edges

WWP	WOW
PO01	WNO
PO02	WSO
PO03	
PO07	
PO08	
PO09	
WBW	
WSW	
WEC	

**4 Select Edge**

Click to view details



**DARRAN**

**Honey**

S-Shaped Workstation Typical  
Desk with Power Fixed Worksurface

5  
12

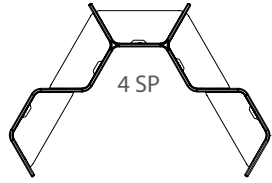

4 SP

8  
18



6 SP

8

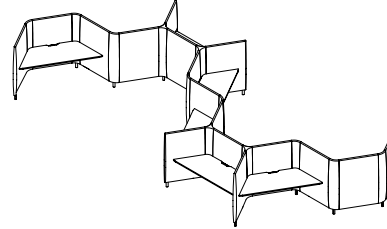

Number of Feet per Typical (MTL10 Option) "SP" Number of Starter Panels per Typical (RSP Option)

**1 Select Model**

w" x d" x h"	Weight	Standard Veneer Top Upholstered Panels - COM\$
347 x 145 x 55	65	8 HNY347145FP586W 39992
217 x 145 x 55	42	5 HNY217145FP586W 25679

Premium Veneer Top Upholstered Panels - COM\$

"P" Option N/A  
"P" Option N/A

High Pressure Laminate Top Upholstered Panels - COM\$

HNY347145FP586G 38392  
HNY217145FP586G 24679

Thermally Fused Laminate Top Upholstered Panels - COM\$

HNY347145FP586M 35336  
HNY217145FP586M 22769

[Click here to view statement of line](#)

**Product Features**

- HNY7226WT162 Fixed Desk Height worksurfaces, 29" worksurface height
- 5" Solid wood feet - oval shape
- 4 Power outlets with 1 telecom plate, see options below for telecom plate
- Ships KD
- Wire management tray attaches to worksurface top, standard in MFW White, see premium Metal Finish for options
- Hardwire infeed and jumpers are included in workstations
- T75 worksurface wire cutout is standard on all worksurfaces.(T75D: Delete cutout is optional)

[Click Here for Graded in Pricing](#)

**2 Select Finish**

Click to view finishes

WWP	WOW
PO01	WNO
PO02	WSO
PO03	WNF(Natural Oak on Flat Cut)
PO07	WSF(Salted Oak on Flat Cut)
PO08	WSF(Salted Oak on Flat Cut)
PO09	WSF(Salted Oak on Flat Cut)
WBW	
WSW	
WEC	

GEC	LW04
GNA +5%	LW05
GWL	LW06
LP01	
LF02	
LF03	
LN01	
LA02	
LW01	
LW02	

MOC
MEC
MSW
MTW
MWL
MNA

**3 Select Feet Finish**

Click to view edges

WWP	WOW
PO01	WNO
PO02	WSO
PO03	
PO07	
PO08	
PO09	
WBW	
WSW	
WEC	

WWP	WOW
PO01	WNO
PO02	WSO
PO03	
PO07	
PO08	
PO09	
WBW	
WSW	
WEC	

WWP	WOW
PO01	WNO
PO02	WSO
PO03	
PO07	
PO08	
PO09	
WEC	
WBW	
WSW	

**4 Select Edge**

Click to view details



**Options**

**Accessories**

- K28: Articulating Keyboard w/ Mouse - \$390
- K31-SK: Center drawer w/ skirt - \$310
- K31: Center drawer w/o skirt - \$205

**Concealed Floor Power Infeed Cover**

- PCEB: White Metal Finish concealed floor power infeed cover - \$150

**Delete Top and Wire Tray**

- DFP: Delete fixed top. Deduct \$1535 Veneer (W), \$1335 High Pressure Laminate (G), \$953 Thermally Fused Laminate (M) per top

**Metal Feet**

- MTL10: Replace solid wood feet with metal feet, standard MFW White - \$55 ea

**Premium Metal Finish**

- Specify premium Metal Finish. MFMB: Matte Black, MFS: Silver, MFSS: Salmon Sienna, MFSA: Surfing Aquavert, MFPS: Pistachio, MFOS: Oyster, MFNA: Navy, MFOL: Olive, MFGB: Grey Beige MFGG: Graphite Gray, MFG: Gray, MFGM:Matte Gold
- Premium Metal Finish for WMT Wire Management Tray - \$75 ea
- Premium Metal Finish for MTL10 Metal Feet - \$20 ea
- Premium Metal Finish for PCEB Concealed Floor Power Infeed Cover - \$35

**Starter Panel**

- RSP: Substitute round starter panel in place of flat starter panel. Must substitute all starters, priced per starter panel - \$83 each. See HNY3555SP888

**Telecom Plates**

- Each power unit has 1 plate. All telecom connectors sold separately.
- RJ45 (1) - \$55, RJ45 (2) - \$110, RJ45 (3) - \$165, USB (1) - \$70, USB (2) - \$140, RJ45/USB - \$125, RJ45/HDMI - \$210, HDMI/USB - \$205

**Worksurface Height**

- THL-42: Modify worksurface height to bar height - N/C

# Honey

120° Lounge  
Lounge with Seat and Back Cushions

[Click here to view statement of line](#)

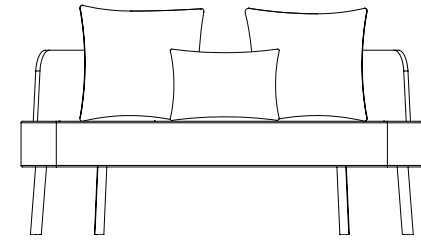

## 1 Model HNY0170HPB48

w" x d" x h"  
60 x 26.5 x 27

COM	COL	1	2	3	4	5	6	7	8	9	10	11/L1	12	13/L2
3563	N/A	3748	3839	3930	4021	4112	4203	4294	4385	4476	4567	4658	4749	4931

Upholstery Requirements  
Fabric yds: 5 Leather Sq. Ft.:90  
Carton Weight:100

## 2 Select Finish

[Click to view finishes](#)

- WWP Designer White
- PO01 Olive on Oak
- PO02 Aquavert on Oak
- PO03 Mushroom on Oak
- PO07 Pebble on Oak
- PO08 Vapour on Oak
- PO09 Verde on Oak
- WEC Ebony
- WNO Natural Oak on Oak
- WSO Salted Oak on Oak
- WBW Henna Walnut on Walnut
- WSW Smokey Walnut on Walnut
- WOW Clear Walnut on Walnut

## 3 Combination Fabrics

[Click to view finishes](#)

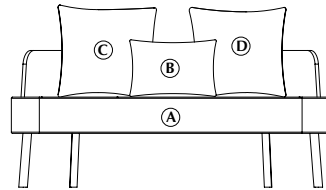

DARRAN is pleased to offer customers the design freedom of combination fabrics. When using fabric, vinyl or leather combinations, pricing/yardage requirements will be as follows:

- A Lounge Seat 2.5 yd. (s)
- B Lounge Pillow 1 yd.
- C Lounge Pillow 1 yd.
- D Lounge Pillow 1 yd.

- When combining two materials of the same grade, pricing will be specified grade + 5%
- If combining two materials of different grades or leather/fabric combination, use the highest grade/price + 5%
- If using COM or COL, pricing will be COM or COL + 5%.
- If both COM + COL are used in combination, use COL + 5%.

## Product Features

- 10.5" Solid wood feet - oval shape
- 4" high resiliency foam seat
- 3/4" Bent plywood back with rift cut oak or walnut veneer
- (2) 20" pillows, (1) 16" pillow
- Solid wood base to maximize strength and longevity

## Options

### Premium Metal Finish

- Specify premium Metal Finish. MFMB: Matte Black, MFS: Silver, MFSS: Salmon Sienna, MFSA: Surfing Aquavert, MFPS: Pistachio, MFOS: Oyster, MFNA: Navy, MFOL: Olive, MFGB: Grey Beige MFGG: Graphite Gray, MFG: Gray, MFGM: Matte Gold
- Premium Metal Finish for MTL12 metal legs: \$20 ea

### Metal Feet

- MTL12: Replace solid wood legs with metal legs, standard in MFW White - \$75 ea

# Honey

120° Starter Panel  
Round End

[Click here to view statement of line](#)

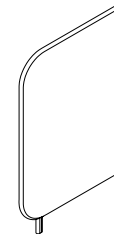

## 1 Model HNY3555SP888

w" x d" x h"  
35 x 3 x 55

COM	COL	1	2	3	4	5	6	7	8	9	10	11/L1	12	13/L2
1041	N/A	1152	1207	1262	1317	1372	1427	1482	1537	1592	1647	1702	1757	1867

Upholstery Requirements  
Fabric yds: 3 Leather Sq. Ft.:N/A  
Carton Weight:20

## Product Features

- 5" Solid wood feet - oval shape

## Notes

- To configure workstations, customer is required to send drawing

## Options

### Metal Feet

- MTL10: Replace solid wood feet with metal feet, standard in MFW White - \$55 ea

### Premium Metal Finish

- Specify premium Metal Finish. MFMB: Matte Black, MFS: Silver, MFSS: Salmon Sienna, MFSA: Surf in Aquavert, MFPS: Pistachio, MFOS: Oyster, MFNA: Navy, MFOL: Olive, MFGB: Grey Beige MFGG: Graphite Gray, MFG: Gray, MFGM: Matte Gold  
- Premium Metal Finish for MTL10: Metal feet \$20 per foot

## 2 Select Finish

[Click to view finishes](#)

- WWP Designer White
- PO01 Olive on Oak
- PO02 Aquavert on Oak
- PO03 Mushroom on Oak
- PO07 Pebble on Oak
- PO08 Vapour on Oak
- PO09 Verde on Oak
- WEC Ebony
- WNO Natural Oak on Oak
- WSO Salted Oak on Oak
- WBW Henna Walnut on Walnut
- WSW Smokey Walnut on Walnut
- WOW Clear Walnut on Walnut

## 3 Combination Fabrics

[Click to view finishes](#)

Combination  
Fabric Option  
Not Available

# Honey

120° Starter Panel  
Flat End

[Click here to view statement of line](#)

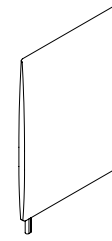

## 1 Model

**HNY3555SP889**

w" x d" x h"  
35 x 3 x 55

COM	COL	1	2	3	4	5	6	7	8	9	10	11/L1	12	13/L2
942	N/A	1053	1108	1163	1218	1273	1328	1383	1438	1493	1548	1603	1658	1768

Upholstery Requirements  
Fabric yds: 3 Leather Sq. Ft.:N/A  
Carton Weight:20

## Product Features

- 5" Solid wood feet - oval shape

## Notes

- To configure workstations, customer is required to send drawing

## Options

### Metal Feet

- MTL10: Replace solid wood feet with metal feet, standard in MFW White - \$55 ea

### Premium Metal Finish

- Specify premium Metal Finish. MFMB: Matte Black, MFS: Silver, MFSS: Salmon Sienna, MFSA: Surfing Aquavert, MFPS: Pistachio, MFOS: Oyster, MFNA: Navy, MFOL: Olive, MFGB: Grey Beige MFGG: Graphite Gray, MFG: Gray, MFGM: Matte Gold  
- Premium Metal Finish for MTL10: Metal feet \$20 per foot

## 2 Select Finish

[Click to view finishes](#)

- WWP Designer White
- PO01 Olive on Oak
- PO02 Aquavert on Oak
- PO03 Mushroom on Oak
- PO07 Pebble on Oak
- PO08 Vapour on Oak
- PO09 Verde on Oak
- WEC Ebony
- WNO Natural Oak on Oak
- WSO Salted Oak on Oak
- WBW Henna Walnut on Walnut
- WSW Smokey Walnut on Walnut
- WOW Clear Walnut on Walnut

## 3 Combination Fabrics

[Click to view finishes](#)

Combination  
Fabric Option  
Not Available

# Honey

120° Corner Panel Connector  
Two Corner Panel

[Click here to view statement of line](#)



## 1 Model

**HNY0955CP890**

w" x d" x h"  
9 x 9 x 55

COM	COL	1	2	3	4	5	6	7	8	9	10	11/L1	12	13/L2
610	N/A	647	665	683	701	719	737	755	773	791	809	827	845	881

Upholstery Requirements  
Fabric yds: 1 Leather Sq. Ft.:N/A  
Carton Weight:10

## Product Features

- 5" Solid wood feet - oval shape

## Notes

- To configure workstations, customer is required to send drawing

## Options

### Metal Feet

- MTL10: Replace solid wood feet with metal feet, standard in MFW White - \$55 ea

### Premium Metal Finish

- Specify premium Metal Finish. MFMB: Matte Black, MFS: Silver, MFSS: Salmon Sienna, MFSA: Surfing Aquavert, MFPS: Pistachio, MFOS: Oyster, MFNA: Navy, MFOL: Olive, MFGB: Grey Beige MFGG: Graphite Gray, MFG: Gray, MFGM: Matte Gold  
- Premium Metal Finish for MTL10: Metal feet \$20 per foot

## 2 Select Finish

[Click to view finishes](#)

- WWP Designer White
- PO01 Olive on Oak
- PO02 Aquavert on Oak
- PO03 Mushroom on Oak
- PO07 Pebble on Oak
- PO08 Vapour on Oak
- PO09 Verde on Oak
- WEC Ebony
- WNO Natural Oak on Oak
- WSO Salted Oak on Oak
- WBW Henna Walnut on Walnut
- WSW Smokey Walnut on Walnut
- WOW Clear Walnut on Walnut

## 3 Combination Fabrics

[Click to view finishes](#)

Combination  
Fabric Option  
Not Available



# Honey

120° Corner Panel Connector  
Three Corner Panel

[Click here to view statement of line](#)

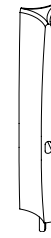

## 1 Model

**HNY0855CP891**

w" x d" x h"  
8 x 8 x 55

COM	COL	1	2	3	4	5	6	7	8	9	10	11/L1	12	13/L2
752	N/A	808	835	862	889	916	943	970	997	1024	1051	1078	1105	1159

Upholstery Requirements  
Fabric yds: 1.5 Leather Sq. Ft.:N/A  
Carton Weight:10

## Product Features

- 5" Solid wood feet - oval shape

## Notes

- To configure workstations, customer is required to send drawing

## Options

### Metal Feet

- MTL10: Replace solid wood feet with metal feet, standard in MFW White - \$55 ea

### Premium Metal Finish

- Specify premium Metal Finish. MFMB: Matte Black, MFS: Silver, MFSS: Salmon Sienna, MFSA: Surf in Aquavert, MFPS: Pistachio, MFOS: Oyster, MFNA: Navy, MFOL: Olive, MFGB: Grey Beige MFGG: Graphite Gray, MFG: Gray, MFGM: Matte Gold  
- Premium Metal Finish for MTL10: Metal feet \$20 per foot

## 2 Select Finish

[Click to view finishes](#)

- WWP Designer White
- PO01 Olive on Oak
- PO02 Aquavert on Oak
- PO03 Mushroom on Oak
- PO07 Pebble on Oak
- PO08 Vapour on Oak
- PO09 Verde on Oak
- WEC Ebony
- WNO Natural Oak on Oak
- WSO Salted Oak on Oak
- WBW Henna Walnut on Walnut
- WSW Smokey Walnut on Walnut
- WOW Clear Walnut on Walnut

## 3 Combination Fabrics

[Click to view finishes](#)

Combination  
Fabric Option  
Not Available

# Honey

In-Line Panel Connector  
 Straight Run Connector

[Click here to view statement of line](#)



## 1 Model HNY1655CP886

w" x d" x h"  
 16 x 3 x 55

COM	COL	1	2	3	4	5	6	7	8	9	10	11/L1	12	13/L2
532	N/A	569	587	605	623	641	659	677	695	713	731	749	767	803

Upholstery Requirements  
 Fabric yds: 1 Leather Sq. Ft.:N/A  
 Carton Weight:20

## Product Features

- 5" Solid wood feet - oval shape

## Notes

- To configure workstations, customer is required to send drawing

## Options

### Metal Feet

- MTL10: Replace solid wood feet with metal feet, standard in MFW White - \$55 ea

### Premium Metal Finish

- Specify premium Metal Finish. MFMB: Matte Black, MFS: Silver, MFSS: Salmon Sienna, MFSA: Surfing Aquavert, MFPS: Pistachio, MFOS: Oyster, MFNA: Navy, MFOL: Olive, MFGB: Grey Beige MFGG: Graphite Gray, MFG: Gray, MFGM: Matte Gold  
 - Premium Metal Finish for MTL10: Metal feet \$20 per foot

## 2 Select Finish

[Click to view finishes](#)

- WWP Designer White
- PO01 Olive on Oak
- PO02 Aquavert on Oak
- PO03 Mushroom on Oak
- PO07 Pebble on Oak
- PO08 Vapour on Oak
- PO09 Verde on Oak
- WEC Ebony
- WNO Natural Oak on Oak
- WSO Salted Oak on Oak
- WBW Henna Walnut on Walnut
- WSW Smokey Walnut on Walnut
- WOW Clear Walnut on Walnut

## 3 Combination Fabrics

[Click to view finishes](#)

Combination  
 Fabric Option  
 Not Available

# Honey

120° Adder Panel  
No Power Access

[Click here to view statement of line](#)

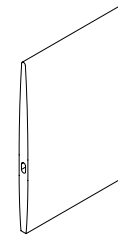

## 1 Model HNY3450AP894

w" x d" x h"  
34 x 3 x 50

COM	COL	1	2	3	4	5	6	7	8	9	10	11/L1	12	13/L2
972	N/A	1083	1138	1193	1248	1303	1358	1413	1468	1523	1578	1633	1688	1798

Upholstery Requirements  
Fabric yds: 3 Leather Sq. Ft.:N/A  
Carton Weight:20

## Product Features

- Adder panel

## Notes

- To configure workstations, customer is required to send drawing  
- Panel overall height is 55" with feet. Panel overall height without feet is 50"

## 2 Select Finish

[Click to view finishes](#)

Finish N/A

## 3 Combination Fabrics

[Click to view finishes](#)

Combination  
Fabric Option  
Not Available

# Honey

120° Adder Access Panel  
Single Sided Access

[Click here to view statement of line](#)

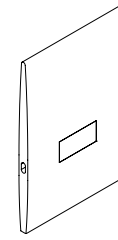

**1 Model**  
**HNY3450AP895**

w" x d" x h"  
34 x 3 x 50

COM	COL	1	2	3	4	5	6	7	8	9	10	11/L1	12	13/L2
1031	N/A	1142	1197	1252	1307	1362	1417	1472	1527	1582	1637	1692	1747	1857

Upholstery Requirements  
Fabric yds: 3 Leather Sq. Ft.:N/A  
Carton Weight:20

**Product Features**

- Panel features access panel for wire management

**Notes**

- To configure workstations, customer is required to send drawing
- Panel overall height is 55" with feet. Panel overall height without feet is 50"
- Removable panel allows wire access for cable management

**2 Select Finish**

[Click to view finishes](#)

Finish N/A

**3 Combination Fabrics**

[Click to view finishes](#)

Combination  
Fabric Option  
Not Available

# Honey

120° Single Sided Power Panel  
Power Panel

[Click here to view statement of line](#)

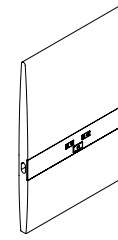

**1 Model**  
**HNY3450PP892**

w" x d" x h"  
34 x 3 x 50

COM	COL	1	2	3	4	5	6	7	8	9	10	11/L1	12	13/L2
1169	N/A	1280	1335	1390	1445	1500	1555	1610	1665	1720	1775	1830	1885	1995

Upholstery Requirements  
Fabric yds: 3 Leather Sq. Ft.:N/A  
Carton Weight:20

**2 Select Finish**

[Click to view finishes](#)

Finish N/A

**3 Combination Fabrics**

[Click to view finishes](#)

Combination  
Fabric Option  
Not Available

**Product Features**

- 4 power outlets with 1 telecom plate, see options below for telecom plate

**Notes**

- To configure workstations, customer is required to send drawing
- Panel overall height is 55" with feet. Panel overall height without feet is 50"
- Jumper(s) or hardwired infeed must be selected to power workstations. See options below.

**Options**

**Jumper(s) and Infeed**

- Specify Jumper or Infeed to power workstations
- JC42: 42" Length jumper, passes through corner post connecting panel to panel - \$145.
- JC96: 96" Length jumper, passes through 1 adder panel connecting 3 panels - \$215
- JC150: 150" Length jumper passes through 2 adder panels connecting 4 panels - \$290
- JC204: 204" Length jumper passes through corner post connecting 3 panels - \$350
- HPPF192: 192" hardwired power feed -\$350
- CPF72: 72" corded power feed -\$275

**Telecom Plates**

- Each power unit has 1 plate. All telecom connectors sold separately.
- RJ45 (1) - \$55, RJ45 (2) - \$110, RJ45 (3) - \$165, USB (1) - \$70, USB (2) - \$140, RJ45/USB - \$125, RJ45/HDMI - \$210, HDMI/USB - \$205

# Honey

120° Double Sided Power Panel  
Power Panel

[Click here to view statement of line](#)

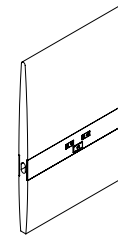

**1 Model**  
**HNY3450PP893**

w" x d" x h"  
34 x 3 x 50

COM	COL	1	2	3	4	5	6	7	8	9	10	11/L1	12	13/L2
1251	N/A	1362	1417	1472	1527	1582	1637	1692	1747	1802	1857	1912	1967	2077

Upholstery Requirements  
Fabric yds: 3 Leather Sq. Ft.:N/A  
Carton Weight:20

**2 Select Finish**

[Click to view finishes](#)

Finish N/A

**3 Combination Fabrics**

[Click to view finishes](#)

Combination  
Fabric Option  
Not Available

**Product Features**

- Double sided power panel, each panel side features 4 power outlets with 1 telecom plate. See options below for telecom plate

**Notes**

- To configure workstations, customer is required to send drawing
- Panel overall height is 55" with feet. Panel overall height without feet is 50"
- Jumper(s) or hardwired infeed must be selected to power workstations. See options below.

**Options**

**Jumper(s) and Infeed**

- Specify Jumper or Infeed to power workstations
- JC42: 42" Length jumped, passes through corner post connecting panel to panel - \$145.
- JC96: 96" Length jumper, passes through 1 adder panel connecting 3 panels - \$215
- JC150: 150" Length jumper passes through 2 adder panels connecting 4 panels - \$290
- JC204: 204" Length jumper passes through corner post connecting 3 panels - \$350
- HPF192: 192" hardwired power feed -\$350
- CPF72: 72" corded power feed -\$275

**Telecom Plates**

- Each power unit has 1 plate. All telecom connectors sold separately.
- RJ45 (1) - \$55, RJ45 (2) - \$110, RJ45 (3) - \$165, USB (1) - \$70, USB (2) - \$140, RJ45/USB - \$125, RJ45/HDMI - \$210, HDMI/USB - \$205

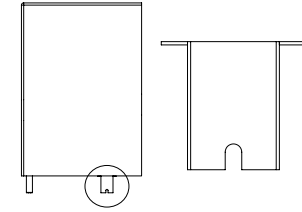

Shown on  
HNY3555SP88  
Panel not incl

1 Select Model

Weight

Power Infeed Cover

w" x d" x h"

5 x 2 x 6

PCEB

164

2 Select Finish

Click to view finishes

MFW

3 Select Feet Finish

Click to view edges

4 Select Edge

Click to view details

Edge  
N/A

[Click here to view statement of line](#)

**Product Features**

- Conceals wire infeed from the floor and mounts to the bottom of honey panels
- White Metal Finish standard

**Notes**

- PANEL NOT INCLUDED

**Options**

**Premium Metal Finish - Power Box**

- Specify Metal Finish upcharge. MFB Black, MFMB: Matte Black, MFS: Silver, MFSS: Salmon Sienna, MFSA: Surfin Aquavert, MFPS: Pistachio, MFOS: Oyster, MFNA: Navy, MFOL: Olive, MFGB: Grey Beige MFGG: Graphite Gray, MFG: Gray - \$35

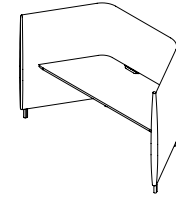

Panels  
not included

[Click here to view statement of line](#)

**1 Select Model**

Weight

Standard Veneer Top

Premium Veneer Top

High Pressure Laminate Top

Thermally Fused Laminate Top

w" x d" x h"	Weight	Standard Veneer Top	Premium Veneer Top
72 x 26 x 1	60	HNY7226WT260W 1325	"P" Option N/A
63.5 x 19 x 1	50	HNY6319WT160W 1113	"P" Option N/A
Desk Height 29"			
72 x 26 x 1	60	HNY7226WT162W 1325	"P" Option N/A
63.5 x 19 x 1	50	HNY6319WT162W 1113	"P" Option N/A

**2 Select Finish**

[Click to view finishes](#)

WWP	WOW
PO01	WNO
PO02	WSO
PO03	
PO07	
PO08	
PO09	
WBW	
WSW	
WEC	

**3 Select Feet Finish**

[Click to view edges](#)

**4 Select Edge**

[Click to view details](#)

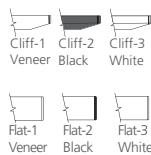

**Product Features**

- 1" Thick top
- Bar height 42", desk height 29"
- Ships KD
- T75 worksurface wire cutout is standard on all worksurfaces.(T75D: Delete cutout is optional)

**Notes**

- PANELS NOT INCLUDED

**Options**

**Wire Tray / Premium Metal Finish**

- WMT: Wire metal tray. Mounts under top and comes standard in MFW White - \$210

**Premium Metal Finish**

- Specify premium Metal Finish. MFMB: Matte Black, MFS: Silver, MFSS: Salmon Sienna, MFSA: Surfin Aquavert, MFPS: Pistachio, MFOS: Oyster, MFNA: Navy, MFOL: Olive, MFGB: Grey Beige MFGG: Graphite Gray, MFG: Gray
- Premium Metal Finish for WMT wire management tray - \$75 ea





Height Adjustable Worksurface

Panels not included

[Click here to view statement of line](#)

1 Select Model

Weight

Standard Veneer Top

Premium Veneer Top

High Pressure Laminate Top

Thermally Fused Laminate Top

w" x d" x h"	Weight	Standard Veneer Top	Premium Veneer Top
71 x 25.5 x 1	120	HNY7125WT163W 3845	"P" Option N/A
62.5 x 18 x 1	90	HNY6218WT163W 3632	"P" Option N/A

2 Select Finish

[Click to view finishes](#)

WWP	WOW
PO01	WNO
PO02	WSO
PO03	
PO07	
PO08	
PO09	
WBW	
WSW	
WEC	

3 Select Feet Finish

[Click to view edges](#)

4 Select Edge

[Click to view details](#)

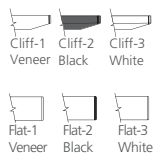

Product Features

- "W/G" worksurfaces are 1" thick, "M" worksurfaces are 1-1/8" thick
- Lift standard in MFW White, optional MFB Black
- Ships KD
- Wire management tray attaches to worksurface top, standard in MFW White, see premium Metal Finish for options
- T75 worksurface wire cutout is standard on all worksurfaces.(T75D: Delete cutout is optional)

Notes

- 1" Gap between worksurface and panels to drop wires below worksurface
- Metal parts include 5 year warranty
- Programmable height adjustable mechanism, motor includes 2 year warranty
- Height adjustable top with mechanism and wire tray only, panels not included

Options

Premium Metal Finish

- Specify premium Metal Finish. MFMB: Matte Black, MFS: Silver, MFSS: Salmon Sienna, MFSA: Surfin Aquavert, MFPS: Pistachio, MFOS: Oyster, MFNA: Navy, MFOL: Olive, MFGB: Grey Beige MFGG: Graphite Gray, MFG: Gray
- Premium Metal Finish for WMT wire management tray - \$75 ea



1 Select Model

Weight

w" x d" x h"	Weight	Standard Veneer Top Metal Base	Premium Veneer Top Metal Base	High Pressure Laminate Top Metal Base	Thermally Fused Laminate Top Metal Base
30 x 30 x 29	50	HNY3029TR379W 1137	"P" Option N/A	HNY3029TR379G 1137	HNY3029TR379M 910
25 x 24 x 24	45	HNY2425TR379W 1072	"P" Option N/A	HNY2425TR379G 1072	HNY2425TR379M 861
18 x 18 x 17	30	HNY1817TR379W 854	"P" Option N/A	HNY1817TR379G 854	HNY1817TR379M 657

Product Features

- 1" Thick top
- Standard white metal base

2 Select Finish

Click to view finishes

WWP	PO07
PM01	PO08
PM02	PO09
PM03	
PM07	
PM08	
PM10	
PO01	
PO02	
PO03	

GEC	LW05
GWL	LW06
LP01	
LF02	
LF03	
LN01	
LA02	
LW01	
LW02	
LW04	

MOC
MEC
MSW
MTW
MWL
MNA

Options

Premium Metal Finish - Table Base

- Specify Metal Finish for table base
- MFMB: Matte Black, MFS: Silver, MFSS: Salmon Sienna, MFSA: Surfin Aquavert, MFPS: Pistachio, MFOS: Oyster, MFNA: Navy, MFOL: Olive, MFGB: Grey Beige, MFGG: Graphite Gray, MFG: Gray - \$175

3 Select Feet Finish

Click to view edges

4 Select Edge

Click to view details

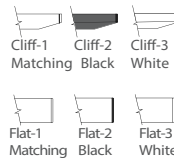
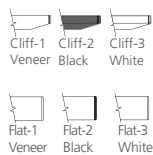

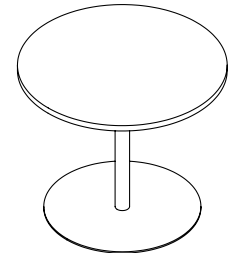

1 Select Model

Weight

w" x d" x h"

Standard Veneer Top  
Metal Base

30 DIA x 29	50	HNY3029RD379W	1112
25 DIA x 24	45	HNY2425RD379W	1072
18 DIA x 17	30	HNY1817RD379W	889

Premium Veneer Top  
Metal Base

"P" Option N/A  
"P" Option N/A  
"P" Option N/A

High Pressure Laminate Top  
Metal Base

HNY3029RD379G	1112
HNY2425RD379G	1072
HNY1817RD379G	878

Thermally Fused Laminate Top  
Metal Base

HNY3029RD379M	868
HNY2425RD379M	861
HNY1817RD379M	698

[Click here to view statement of line](#)

Product Features

- 1" Thick top
- Standard white metal base

Options

Premium Metal Finish - Table Base

- Specify Metal Finish for table base
- MFMB: Matte Black, MFS: Silver, MFSS: Salmon Sienna, MFSA: Surfin Aquavert, MFPS: Pistachio, MFOS: Oyster, MFNA: Navy, MFOL: Olive, MFGB: Grey Beige, MFGG: Graphite Gray, MFG: Gray - \$175

2 Select Finish

[Click to view finishes](#)

WWP	PO07
PM01	PO08
PM02	PO09
PM03	WEC
PM07	WBW
PM08	WSW
PM10	WOW
PO01	WNO
PO02	WSO
PO03	

GEC	LW05
GWL	LW06
LP01	
LF02	
LF03	
LN01	
LA02	
LW01	
LW02	
LW04	

MOC
MEC
MSW
MTW
MWL
MNA

3 Select Feet Finish

[Click to view edges](#)

4 Select Edge

[Click to view details](#)

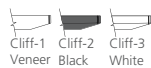

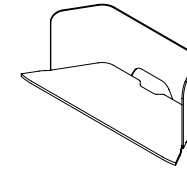

Top  
not included

**1 Select Model**

Weight

Worksurface Screen  
PET

w" x d" x h"

10

PS60

814

60 x 17 x 24

**2 Select Finish**

Click to view finishes

Finish N/A

**3 Select Feet Finish**

Click to view edges

**4 Select acoustic color**

Click to view details

- Light Gray 3
- Deep Blue 9
- Dark Gray 17
- Pure Gray 34
- Berry Red 36
- Ivory 44
- Emerald 47
- Smoky Beige 53
- Heathered Granite 71
- Heathered Oatmeal 75

[Click here to view statement of line](#)

**Product Features**

- Screen attaches to worksurface top
- PET Screen 1/2" thick with rounded corners
- Composed of 100% polyester fiber
- 50% post-consumer recycled content
- Adds additional acoustical absorption

**Notes**

- Available on both 63" and 72" worksurfaces
- Only available on Height Adjustable Worksurfaces

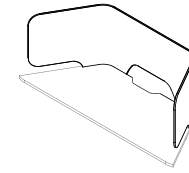

Top  
not included

**1 Select Model**

Weight

Worksurface Screen  
 Veneer Privacy Screen

w" x d" x h"

30

VS64W

2102

**2 Select Finish**

Click to view finishes

- PO01
- PO02
- PO03
- PO07
- PO08
- PO09
- WBW
- WSW
- WEC
- WOW

- WNO
- WSO

**3 Select Feet Finish**

Click to view edges

**4 Select Edge**

Click to view details



Flat

[Click here to view statement of line](#)

**Product Features**

- Screens feature veneer on both sides with rounded corners
- 1/2" Thick screen
- Screen attaches to worksurface top

**Notes**

- Available on both 63" and 72" worksurfaces
- Only available on Height Adjustable Worksurfaces

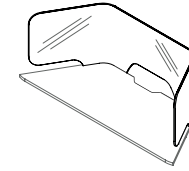

Top  
not included

1 Select Model

w" x d" x h"  
69 x 24 x 24

Weight

20

Worksurface Screen  
Frosted Acrylic

AS64AF

1480

Worksurface Screen  
Matte White Acrylic

AS64AW

1545

Worksurface Screen  
Matte Black Acrylic

AS64AB

1545

2 Select Finish

Click to view finishes

AF

AW

AB

3 Select Feet Finish

Click to view edges

4 Select Edge

Click to view details



Flat



Flat



Flat

[Click here to view statement of line](#)

Product Features

- Acrylic screens with rounded corners
- 1/4" Thick screen
- Screen attaches to worksurface top

Notes

- Matte acrylic is not a writable surface
- Available on both 63" and 72" worksurfaces
- Only available on Height Adjustable Worksurfaces

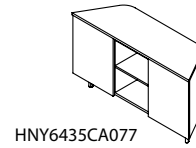

HNY6435CA077

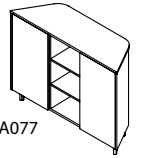

HNY6448CA077

1 Select Model

Weight

Standard Veneer Case  
Solid Wood Feet

Premium Veneer Case  
Solid Wood Feet

High Pressure Laminate Case  
Solid Wood Feet

Thermally Fused Laminate Case  
Solid Wood Feet

w" x d" x h"	Weight	Standard Veneer Case	Premium Veneer Case
64 x 20 x 48	180	HNY6448CA077W 4734	"P" Option N/A
64 x 20 x 35	140	HNY6435CA077W 4213	"P" Option N/A

"P" Option N/A  
"P" Option N/A

HNY6448CA077G	4304
HNY6435CA077G	3831

HNY6448CA077M	3391
HNY6435CA077M	2921

[Click here to view statement of line](#)

Product Features

- 5" Solid wood feet - oval shape
- Dividers and shelves are finished to match case
- Sliding doors

Notes

- Not to be used as freestanding in open plan must slide into 120° panels

Options

Grommets (Vertical Surface)

- Standard location - \$50 each
- Black Plastic Vertical Surface: TM50-C (Bottom Center)
- Non-Standard Location - \$95 each
- Black Plastic Vertical Surface: TM50-NS

Premium Metal Finish

- Specify premium Metal Finish. MFMB: Matte Black, MFS: Silver, MFSS: Salmon, Sienna, MFSA: Surfing Aquavert, MFPS: Pistachio, MFOS: Oyster, MFNA: Navy, MFOL: Olive, MFGB: Grey Beige MFGG: Graphite Gray, MFG: Gray
- Premium Metal Finish for MTL11 Metal Feet: \$20 ea

Metal Feet

- MTL11: Replace solid wood feet with metal feet, standard in MFW White - \$300 per wardrobe

2 Select Finish

Click to view finishes

Case Finishes

Leg Finishes

WWP	PO07	Oak on Flat
PM01	PO08	Cut)
PM02	PO09	WSF(Salted
PM03	WEC	Oak on Flat
PM07	WBW	Cut)
PM08	WSW	
PM10	WOW	
PO01	WNO	
PO02	WSO	
PO03	WNF(Natural	

Case Finishes

Feet Finishes

GEC	LW05
GWL	LW06
LP01	
LF02	
LF03	
LN01	
LA02	
LW01	
LW02	
LW04	

Case Finishes

Feet Finishes

MOC
MEC
MSW
MTW
MWL
MNA

3 Select Feet Finish

Click to view edges

WWP	WOW
PO01	WNO
PO02	WSO
PO03	
PO07	
PO08	
PO09	
WBW	
WSW	
WEC	

WWP	WOW
PO01	WNO
PO02	WSO
PO03	
PO07	
PO08	
PO09	
WBW	
WSW	
WEC	

WWP	WOW
PO01	WNO
PO02	WSO
PO03	
PO07	
PO08	
PO09	
WEC	
WBW	
WSW	

4 Select Edge

Click to view details



Flat



Flat



Flat



HNY6435CA074W



HNY6448CA074W

1 Select Model

w" x d" x h"	Weight
64 x 20 x 48	150
64 x 20 x 35	120

Standard Veneer Case  
Solid Wood Feet

HNY6448CA074W	3530
HNY6435CA074W	3140

Premium Veneer Case  
Solid Wood Feet

"P" Option N/A  
"P" Option N/A

High Pressure Laminate Case  
Solid Wood Feet

HNY6448CA074G	3208
HNY6435CA074G	2854

Thermally Fused Laminate Case  
Solid Wood Feet

HNY6448CA074M	2031
HNY6435CA074M	1678

[Click here to view statement of line](#)

Product Features

- 5" Solid wood feet - oval shape
- Dividers and shelves are finished to match case

Notes

- Not to be used as freestanding in open plan must slide into 120° panels

Options

Grommets (Vertical Surface)

- Standard location - \$50 each
- Black Plastic Vertical Surface: TM50-C (Bottom Center)
- Non-Standard Location - \$95 each
- Black Plastic Vertical Surface: TM50-NS

Premium Metal Finish

- Specify premium Metal Finish. MFMB: Matte Black, MFS: Silver, MFSS: Salmon Sienna, MFSA: Surfing Aquavert, MFPS: Pistachio, MFOS: Oyster, MFNA: Navy, MFOL: Olive, MFGB: Grey Beige MFGG: Graphite Gray, MFG: Gray
- Premium Metal Finish for MTL11 Metal Feet: \$20 ea

Metal Feet

- MTL11: Replace solid wood feet with metal feet, standard in MFW White - \$300 per wardrobe

2 Select Finish

[Click to view finishes](#)

Case Finishes	Leg Finishes
WWP	PO07 ral Oak on
PM01	PO08 Flat Cut)
PM02	PO09 WSF(Salted
PM03	WEC Oak on Flat
PM07	WBW Cut)
PM08	WSW
PM10	WOW
PO01	WNO
PO02	WSO
PO03	WNF(Natu-

Case Finishes	Feet Finishes	Case Finishes	Feet Finishes
GEC	LW05	MOC	
GWL	LW06	MEC	
LP01		MSW	
LF02		MTW	
LF03		MWL	
LN01		MNA	
LA02			
LW01			
LW02			
LW04			

3 Select Feet Finish

[Click to view edges](#)

WWP	WOW
PO01	WNO
PO02	WSO
PO03	
PO07	
PO08	
PO09	
WBW	
WSW	
WEC	

WWP	WOW	WWP	WOW
PO01	WNO	PO01	WNO
PO02	WSO	PO02	WSO
PO03		PO03	
PO07		PO07	
PO08		PO08	
PO09		PO09	
WBW		WEC	
WSW		WBW	
WEC		WSW	

4 Select Edge

[Click to view details](#)



Flat



Flat



Flat



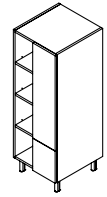

1 Select Model

w" x d" x h"  
20 x 20 x 55

Weight  
200

Standard Veneer Case  
Solid Wood Feet  
HNY2055TW300W 3228

Premium Veneer Case  
Solid Wood Feet  
"P" Option N/A

High Pressure Laminate Case  
Solid Wood Feet  
HNY2055TW300G 2935

Thermally Fused Laminate Case  
Solid Wood Feet  
HNY2055TW300M 2005

[Click here to view statement of line](#)

Product Features

- 5" Solid wood feet - oval shape
- Three fixed open shelves, pull out drawer and wardrobe
- Dividers and shelves are finished to match case
- Full extension drawers
- Finished tops
- Soft close suspensions
- Touch latch doors

2 Select Finish

[Click to view finishes](#)

Case Finishes	Leg Finishes
WWP	PO07 ral Oak on
PM01	PO08 Flat Cut)
PM02	PO09 WSF(Salted
PM03	WEC Oak on Flat
PM07	WBW Cut)
PM08	WSW
PM10	WOW
PO01	WNO
PO02	WSO
PO03	WNF(Natu-

Case Finishes	Feet Finishes	Case Finishes	Feet Finishes
GEC	LW05	MOC	
GWL	LW06	MEC	
LP01		MSW	
LF02		MTW	
LF03		MWL	
LN01		MNA	
LA02			
LW01			
LW02			
LW04			

Options

Door

- D2: Door Lock - \$100 per door set
- D6: Delete doors - n/c
- D9SC: Soft Close Door Hinges - \$20 per door

Drawer

- P33: Wood Drawer Upgrade - \$45 per drawer
- D2: Door Lock - \$100 per door set

Premium Metal Finish

- Specify premium Metal Finish. MFMB: Matte Black, MFS: Silver, MFSS: Salmon Sienna, MFSA: Surfing Aquavert, MFPS: Pistachio, MFOS: Oyster, MFNA: Navy, MFOL: Olive, MFGB: Grey Beige MFGG: Graphite Gray, MFG: Gray
- Premium Metal Finish for MTL11 Metal Feet: \$80 per wardrobe

Metal Feet

- MTL11: Replace solid wood feet with metal feet, standard in MFW White - \$300 per wardrobe

3 Select Feet Finish

[Click to view edges](#)

WWP	WOW
PO01	WNO
PO02	WSO
PO03	
PO07	
PO08	
PO09	
WBW	
WSW	
WEC	

WWP	WOW	WWP	WOW
PO01	WNO	PO01	WNO
PO02	WSO	PO02	WSO
PO03		PO03	
PO07		PO07	
PO08		PO08	
PO09		PO09	
WBW		WEC	
WSW		WBW	
WEC		WSW	

4 Select Edge

[Click to view details](#)



Flat



Flat



Flat

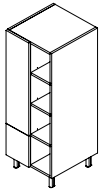

**1 Select Model**

w" x d" x h"  
20 x 20 x 55

Weight  
200

Standard Veneer Case  
Solid Wood Feet  
HNY2055TW301W 3228

Premium Veneer Case  
Solid Wood Feet  
"P" Option N/A

High Pressure Laminate Case  
Solid Wood Feet  
HNY2055TW301G 2935

Thermally Fused Laminate Case  
Solid Wood Feet  
HNY2055TW301M 2005

[Click here to view statement of line](#)

**Product Features**

- 5" Solid wood feet - oval shape
- Three fixed open shelves, pull out drawer and wardrobe
- Dividers and shelves are finished to match case
- Full extension drawers
- Finished tops
- Soft close suspensions
- Touch latch doors

**2 Select Finish**

[Click to view finishes](#)

Case Finishes	Leg Finishes
WWP	PO07 ral Oak on
PM01	PO08 Flat Cut)
PM02	PO09 WSF(Salted
PM03	WEC Oak on Flat
PM07	WBW Cut)
PM08	WSW
PM10	WOW
PO01	WNO
PO02	WSO
PO03	WNF(Natu-

Case Finishes	Feet Finishes	Case Finishes	Feet Finishes
GEC	LW05	MOC	
GWL	LW06	MEC	
LP01		MSW	
LF02		MTW	
LF03		MWL	
LN01		MNA	
LA02			
LW01			
LW02			
LW04			

**Options**

**Door**

- D2: Door Lock - \$100 per door set
- D6: Delete doors - n/c
- D9SC: Soft Close Door Hinges - \$20 per door

**Drawer**

- P33: Wood Drawer Upgrade - \$45 per drawer
- D2: Door Lock - \$100 per door set

**Premium Metal Finish**

- Specify premium Metal Finish. MFMB: Matte Black, MFS: Silver, MFSS: Salmon Sienna, MFSA: Surfing Aquavert, MFPS: Pistachio, MFOS: Oyster, MFNA: Navy, MFOL: Olive, MFGB: Grey Beige MFGG: Graphite Gray, MFG: Gray
- Premium Metal Finish for MTL11 Metal Feet: \$80 per wardrobe

**Metal Feet**

- MTL11: Replace solid wood feet with metal feet, standard in MFW White - \$300 per wardrobe

**3 Select Feet Finish**

[Click to view edges](#)

WWP	WOW
PO01	WNO
PO02	WSO
PO03	
PO07	
PO08	
PO09	
WBW	
WSW	
WEC	

WWP	WOW	WWP	WOW
PO01	WNO	PO01	WNO
PO02	WSO	PO02	WSO
PO03		PO03	
PO07		PO07	
PO08		PO08	
PO09		PO09	
WBW		WEC	
WSW		WBW	
WEC		WSW	

**4 Select Edge**

[Click to view details](#)



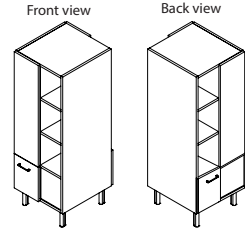

1 Select Model

w" x d" x h"  
20 x 20 x 55

Weight

200

2 HNY2055TW299W 3717

Standard Veneer  
Solid Wood Case

Premium Veneer  
Solid Wood Case

"P" Option N/A

High Pressure Laminate  
Solid Wood Case

HNY2055TW299G 3379

Thermally Fused Laminate  
Solid Wood Case

HNY2055TW299M 2308

[Click here to view statement of line](#)

Product Features

- 5" Solid wood feet - oval shape
- Comes with three fixed shelves and pull out drawer on each side
- Full extension drawers
- Soft close suspensions
- Finished tops
- Touch latch doors

Notes

- Unit is designed for open plan use
- Sold as one unit

Options

Door

- D2: Door Lock - \$100 per door set
- D6: Delete doors - n/c
- D9SC: Soft Close Door Hinges - \$20 per door

Drawer

- P33: Wood Drawer Upgrade - \$45 per drawer
- D2: Door Lock - \$100 per door set

Premium Metal Finish

- Specify premium Metal Finish. MFMB: Matte Black, MFS: Silver, MFSS: Salmon Sienna, MFSA: Surfin Aquavert, MFPS: Pistachio, MFOS: Oyster, MFNA: Navy, MFOL: Olive, MFGB: Grey Beige MFGG: Graphite Gray, MFG: Gray
- Premium Metal Finish for MTL11 Metal Feet: \$80

Metal Feet

- MTL11: Replace solid wood feet with metal feet, standard in MFW White - \$300 per wardrobe

2 Select Finish

[Click to view finishes](#)

Case Finishes	Leg Finishes
WWP	PO07 ral Oak on
PM01	PO08 Flat Cut)
PM02	PO09 WSF(Salted
PM03	WEC Oak on Flat
PM07	WBW Cut)
PM08	WSW
PM10	WOW
PO01	WNO
PO02	WSO
PO03	WNF(Natu-

3 Select Feet Finish

[Click to view edges](#)

WWP	WOW
PO01	WNO
PO02	WSO
PO03	
PO07	
PO08	
PO09	
WBW	
WSW	
WEC	

4 Select Edge

[Click to view details](#)



Flat

Case Finishes	Feet Finishes	Case Finishes	Feet Finishes
GEC	LW05	MOC	
GWL	LW06	MEC	
LP01		MSW	
LF02		MTW	
LF03		MWL	
LN01		MNA	
LA02			
LW01			
LW02			
LW04			

WWP	WOW	WWP	WOW
PO01	WNO	PO01	WNO
PO02	WSO	PO02	WSO
PO03		PO03	
PO07		PO07	
PO08		PO08	
PO09		PO09	
WBW		WEC	
WSW		WBW	
WEC		WSW	



Flat



Flat

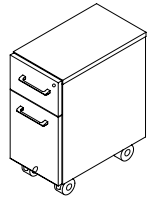

1 Select Model

w" x d" x h"  
10 x 18 x 23

Weight  
40

Standard Veneer Pedestal

HNY1018PD423W 1413

Premium Veneer Pedestal

"P" Option N/A

High Pressure Laminate Pedestal

HNY1018PD423G 1219

Thermally Fused Laminate Pedestal

HNY1018PD423M 1077

[Click here to view statement of line](#)

Product Features

- Product features.
- 3" Hollow white wheel caster, black caster available
  - Anti-tilt safety feature
  - Finished all sides and top - open plan
  - Full extension drawers
  - Drawer lock

2 Select Finish

[Click to view finishes](#)

WWP	PO07	ral Oak on
PM01	PO08	Flat Cut)
PM02	PO09	WSF(Salted
PM03	WEC	Oak on Flat
PM07	WBW	Cut)
PM08	WSW	
PM10	WOW	
PO01	WNO	
PO02	WSO	
PO03	WNF(Natu-	

GEC	LW05
GWL	LW06
LP01	
LF02	
LF03	
LN01	
LA02	
LW01	
LW02	
LW04	

MOC
MEC
MSW
MTW
MWL
MNA

Options

Cushion

- BC10: Bench Cushion
- Specify fabric grade (.5 yd. required)

Drawer

- P33: Wood Drawer Upgrade - \$45 per drawer

BC10 CUSHION FABRIC GRADES.

COM	COL	1	2	3
223	242	260	278	296
4	5	6	7	8
314	332	350	368	386
9	10	11	12	13
404	422	440	458	494

3 Select Feet Finish

[Click to view edges](#)

4 Select Edge

[Click to view details](#)



Flat



Flat



Flat

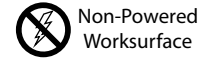
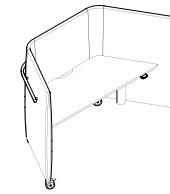

**1 Select Model**

Weight	Standard Veneer Top Upholstered Panels - COM\$	Premium Veneer Top Upholstered Panels - COM\$	High Pressure Laminate Top Upholstered Panels - COM\$	Thermally Fused Laminate Top Upholstered Panels - COM\$
w" x d" x h"				
85 x 37 x 55	11.5	1 HNY8537HA569W 8758	"P" Option N/A	HNY8537HA569M 8176

[Click Here for Graded in Pricing](#)

**2 Select Finish**

Click to view finishes

**Case Finishes**

WWP	WNO
PO01	WSO
PO02	WEC
PO03	WNF(Natural Oak on Flat Cut)
PO07	WSF(Salted Oak on Flat Cut)
PO08	WSF(Salted Oak on Flat Cut)
PO09	WSF(Salted Oak on Flat Cut)
WBW	
WSW	
WOW	

**3 Select Feet Finish**

Click to view edges

WWP	WOW
PO01	WNO
PO02	WSO
PO03	
PO07	
PO08	
PO09	
WBW	
WSW	
WEC	

**4 Select Edge**

Click to view details



**Case Finishes**

GEC	LW05
GWL	LW06
LP01	
LF02	
LF03	
LN01	
LA02	
LW01	
LW02	
LW04	

WWP	WOW
PO01	WNO
PO02	WSO
PO03	
PO07	
PO08	
PO09	
WBW	
WSW	
WEC	



**Case Finishes**

MOC
MEC
MSW
MTW
MWL
MNA

WWP	WOW
PO01	WNO
PO02	WSO
PO03	
PO07	
PO08	
PO09	
WEC	
WBW	
WSW	



[Click here to view statement of line](#)

**Product Features**

- 1" Gap between worksurface and panels to drop wires below worksurface
- Programmable height adjustable mechanism, motor includes 2 year warranty
- Wood hand rails around outside mounted on wood standoffs
- 2 locking and 2 non-locking casters. Available in BK: Black (standard) or GR: Grey (optional)
- Adjustable height from 27" to 47.5" with a maximum weight capacity of 275 lbs. Lift standard in MFW White, optional MFB Black
- HNY7125WT163 Height Adjustable worksurfaces is included
- Wire management tray attaches to worksurface top, standard in MFW White, see premium Metal Finish for options
- T75 worksurface wire cutout is standard on all worksurfaces.(T75D: Delete cutout is optional)

**Options**

**Accessories**

- K28: Articulating Keyboard w/ Mouse - \$390
- K31-SK: Center drawer w/ skirt - \$310
- K31: Center drawer w/o skirt - \$205

**Casters**

- 2 locking and 2 non-locking casters. Available in BK: Black (standard) or GR: Grey (optional)

**Premium Metal Finish**

- Specify premium Metal Finish. MFMB: Matte Black, MFS: Silver, MFSS: Salmon Sienna, MFSA: Surfing Aquavert, MFPS: Pistachio, MFOS: Oyster, MFNA: Navy, MFOL: Olive, MFGB: Grey Beige, MFGG: Graphite Gray, MFG: Gray
- Premium Metal Finish for WMT Wire Management Tray - \$75 ea
- Premium Metal Finish for PCEB Concealed Floor Power Infeed Cover - \$35

**Tully Inline Power**

- PD-TULLY-IN-72: 2 power/dual USB up, 4 power down, 72" power cord - \$605
- PD-TULLY-IN-120: 2 power/dual USB up, 4 power down, 120" power cord - \$625

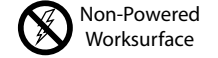
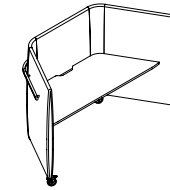

**1 Select Model**

Weight

Standard Veneer Top  
Upholstered Panels - COM\$

Premium Veneer Top  
Upholstered Panels - COM\$

High Pressure Laminate Top  
Upholstered Panels - COM\$

Thermally Fused Laminate Top  
Upholstered Panels - COM\$

w" x d" x h"  
85 x 37 x 55      10.5      1 HNY8537FT569W      6239

"P" Option N/A

HNY8537FT569G      6039

HNY8537FT569M      5656

[Click here to view statement of line](#)

**Product Features**

- T75 worksurface wire cutout is standard on all worksurfaces.(T75D: Delete cutout is optional)
- Wood hand rails around outside mounted on wood standoffs
- 2 locking and 2 non-locking casters. Available in BK: Black (standard) or GR: Grey (optional)
- HNY7226WT162 Fixed Desk Height worksurfaces, 29" worksurface height
- Ships KD

**Options**

**Accessories**

- K28: Articulating Keyboard w/ Mouse - \$390
- K31-SK: Center drawer w/ skirt - \$310
- K31: Center drawer w/o skirt - \$205

**Casters**

- 2 locking and 2 non-locking casters. Available in BK: Black (standard) or GR: Grey (optional)

**Wire Tray**

- WMT: Wire metal tray. Mounts under top and comes standard in MFW White - \$210

**Premium Metal Finish**

- Specify premium Metal Finish. MFMB: Matte Black, MFS: Silver, MFSS: Salmon Sienna, MFSA: Surfin Aquavert, MFPS: Pistachio, MFOS: Oyster, MFNA: Navy, MFOL: Olive, MFGB: Grey Beige MFGG: Graphite Gray, MFG: Gray
- Premium Metal Finish for WMT Wire Management Tray - \$75 ea

**Tully Inline Power**

- PD-TULLY-IN-72: 2 power/dual USB up, 4 power down, 72" power cord - \$605
- PD-TULLY-IN-120: 2 power/dual USB up, 4 power down, 120" power cord - \$625

[Click Here for Graded in Pricing](#)

**2 Select Finish**

[Click to view finishes](#)

**Case Finishes**

WWP	WNO
PO01	WSO
PO02	WEC
PO03	WNF(Natural Oak on Flat Cut)
PO07	WSF(Salted Oak on Flat Cut)
PO08	
PO09	
WBW	
WSW	
WOW	

**Case Finishes**

GEC	LW05
GWL	LW06
LP01	
LF02	
LF03	
LN01	
LA02	
LW01	
LW02	
LW04	

**Leg Finishes**

WWP	WOW
PO01	WNO
PO02	WSO
PO03	
PO07	
PO08	
PO09	
WBW	
WSW	
WEC	

**Case Finishes Leg Finishes**

MOC	
MEC	
MSW	
MTW	
MWL	
MNA	
WWP	WOW
PO01	WNO
PO02	WSO
PO03	
PO07	
PO08	
PO09	
WEC	
WBW	
WSW	

**3 Select Feet Finish**

[Click to view edges](#)

WWP	WOW
PO01	WNO
PO02	WSO
PO03	
PO07	
PO08	
PO09	
WBW	
WSW	
WEC	

**4 Select Edge**

[Click to view details](#)

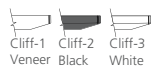



Desk and Panels  
not included

Return shown in black



Non-Powered  
Worksurface

Pricing for return top only

[Click here to view statement of line](#)

**1 Select Model**

Weight

Standard Veneer Top

Premium Veneer Top

High Pressure Laminate Top

Thermally Fused Laminate Top

w" x d" x h"  
Left Return Desk Height  
42 x 24 x 1

25

HNY4224WT167W 954

"P" Option N/A

HNY4224WT167G 755

HNY4224WT167M 490

Left Return Bar Height  
42 x 24 x 1

25

HNY4224WT169W 954

"P" Option N/A

HNY4224WT169G 755

HNY4224WT169M 490

**Product Features**

- "W/G" worksurfaces are 1" thick, "M" worksurfaces are 1-1/8" thick
- Ships KD
- Includes mounting hardware
- Bar height 42"
- Desk Height 29"
- Cannot be sold freestanding, must hook to fixed worksurface desk

**Notes**

- PANELS NOT INCLUDED
- Desk sold separately

**Options**

**Grommet (Standard Location)**

Specify Color and Location Right/Left - \$50 ea.

- Black: TM30-R (Right), TM30-L (Left)
- Silver: TM31-R (Right), TM31-L (Left)
- White: TM34-R (Right), TM34-L (Left)

**2 Select Finish**

[Click to view finishes](#)

WWP	WNO
PO01	WSO
PO02	WEC
PO03	WNF(Natural Oak on Flat Cut)
PO07	WSF(Salted Oak on Flat Cut)
PO08	
PO09	
WBW	
WSW	
WOW	

GEC	LW05
GWL	LW06
LP01	
LF02	
LF03	
LN01	
LA02	
LW01	
LW02	
LW04	

MOC
MEC
MSW
MTW
MWL
MNA

**3 Select Feet Finish**

[Click to view edges](#)

**4 Select Edge**

[Click to view details](#)

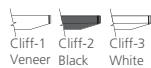

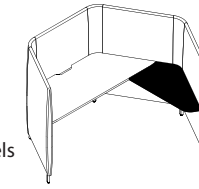

Desk and Panels  
not included

Return shown in black  
Pricing for return top only

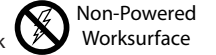

**1 Select Model**

Weight

Standard Veneer Top

Premium Veneer Top

High Pressure Laminate Top

Thermally Fused Laminate Top

w" x d" x h"  
Right Return Desk Height  
42 x 24 x 1      25

HNY4224WT168W    954

"P" Option N/A

HNY4224WT168G    755

HNY4224WT168M    490

Right Return Bar Height  
42 x 24 x 1      25

HNY4224WT170W    954

"P" Option N/A

HNY4224WT170G    755

HNY4224WT170M    490

**2 Select Finish**

Click to view finishes

- |      |                                 |
|------|---------------------------------|
| WWP  | WNO                             |
| PO01 | WSO                             |
| PO02 | WEC                             |
| PO03 | WNF(Natural Oak<br>on Flat Cut) |
| PO07 | WSF(Salted Oak<br>on Flat Cut)  |
| PO08 |                                 |
| PO09 |                                 |
| WBW  |                                 |
| WSW  |                                 |
| WOW  |                                 |

- GEC LW05  
GWL LW06  
LP01  
LF02  
LF03  
LN01  
LA02  
LW01  
LW02  
LW04

- MOC  
MEC  
MSW  
MTW  
MWL  
MNA

**3 Select Feet Finish**

Click to view edges

**4 Select Edge**

Click to view details

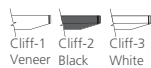

[Click here to view statement of line](#)

**Product Features**

- "W/G" worksurfaces are 1" thick, "M" worksurfaces are 1-1/8" thick
- Ships KD
- Includes mounting hardware
- Bar height 42"
- Desk Height 29"
- Cannot be sold freestanding, must hook to fixed worksurface desk

**Notes**

- PANELS NOT INCLUDED
- Desk sold separately

**Options**

**Grommet (Standard Location)**

Specify Color and Location Right/Left - \$50 ea.

- Black: TM30-R (Right), TM30-L (Left)
- Silver: TM31-R (Right), TM31-L (Left)
- White: TM34-R (Right), TM34-L (Left)



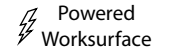
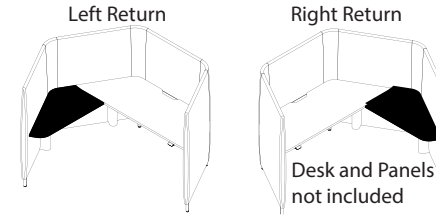

Return shown in black. Pricing for return top with lift only

[Click here to view statement of line](#)

**1 Select Model**

Weight	Standard Veneer Top		Premium Veneer Top		High Pressure Laminate Top		Thermally Fused Laminate Top	
w" x d" x h"								
Left Return 42 x 24 x 1	25	HNY4224WT165W 1913	"P" Option N/A	HNY4224WT165G 1673	HNY4224WT165M 1525			
Right Return 42 x 24 x 1	25	HNY4224WT166W 1913	"P" Option N/A	HNY4224WT166G 1673	HNY4224WT166M 1525			

**Product Features**

- "W/G" worksurfaces are 1" thick, "M" worksurfaces are 1-1/8" thick
- Lift standard in MFW White, optional MFB Black
- Ships KD
- Includes mounting hardware
- Cannot be sold freestanding, must hook to lift desk

**2 Select Finish**

[Click to view finishes](#)

WWP	WNO
PO01	WSO
PO02	WEC
PO03	WNF(Natural Oak on Flat Cut)
PO07	WSF(Salted Oak on Flat Cut)
PO08	
PO09	
WBW	
WSW	
WOW	

GEC	LW05
GWL	LW06
LP01	
LF02	
LF03	
LN01	
LA02	
LW01	
LW02	
LW04	

MOC
MEC
MSW
MTW
MWL
MNA

**Notes**

- 1" Gap between worksurface and panels to drop wires below worksurface
- Programmable height adjustable mechanism, motor includes 2 year warranty
- Height adjustable top with mechanism and wire tray only, panels not included
- Lift desk sold separately

**Options**

**Grommet (Standard Location)**

Specify Color and Location Right/Left - \$50 ea.

- Black: TM30-R (Right), TM30-L (Left)
- Silver: TM31-R (Right), TM31-L (Left)
- White: TM34-R (Right), TM34-L (Left)

**3 Select Feet Finish**

[Click to view edges](#)

**4 Select Edge**

[Click to view details](#)

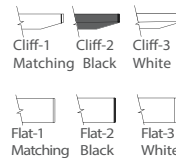
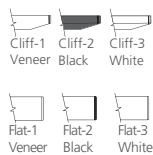



## Honey 90 Degree

Effective June 2022

Designed By Mark Müller and Chris Wright

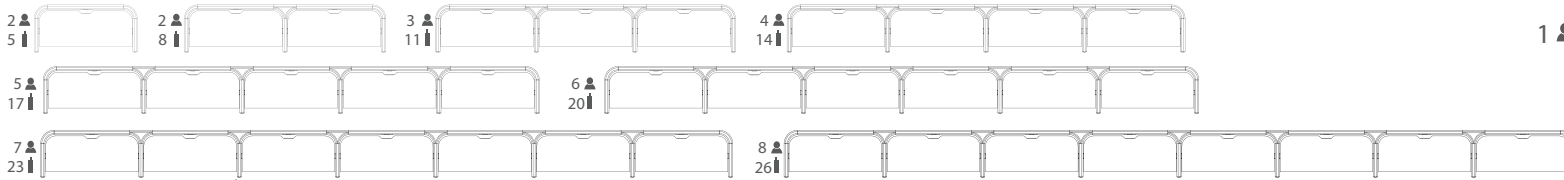

Number of Feet per Typical (MTL10 Option)

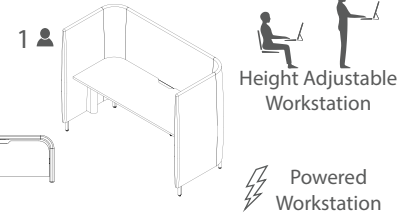

1 Select Model

Weight	Standard Veneer Top Upholstered Panels - COM\$
563 x 34 x 55	8 HNY56334HA553W 61022
490 x 34 x 55	7 HNY49034HA553W 53584
421 x 34 x 55	6 HNY42134HA553W 46146
351 x 34 x 55	5 HNY35134HA553W 38708
282 x 34 x 55	4 HNY28234HA553W 31270
212 x 34 x 55	3 HNY21234HA553W 23832
143 x 34 x 55	2 HNY14334HA553W 16394
73 x 34 x 55	1 HNY7334HA553W 8956

Premium Veneer Top Upholstered Panels - COM\$
"P" Option N/A
"P" Option N/A
"P" Option N/A
"P" Option N/A
"P" Option N/A
"P" Option N/A
"P" Option N/A
"P" Option N/A

High Pressure Laminate Top Upholstered Panels - COM\$
HNY56334HA553G 59414
HNY49034HA553G 52177
HNY42134HA553G 44940
HNY35134HA553G 37703
HNY28234HA553G 30466
HNY21234HA553G 23229
HNY14334HA553G 15992
HNY7334HA553G 8755

Thermally Fused Laminate Top Upholstered Panels - COM\$
HNY56334HA553M 56358
HNY49034HA553M 49503
HNY42134HA553M 42648
HNY35134HA553M 35793
HNY28234HA553M 28938
HNY21234HA553M 22083
HNY14334HA553M 15228
HNY7334HA553M 8373

[Click here to view statement of line](#)

Product Features

- HNY6625WT163 Height Adjustable worksurfaces are included
- 5" Solid wood feet - oval shape
- 4 Power outlets with 1 telecom plate, see options below for telecom plate
- Ships KD
- Wire management tray attaches to worksurface top, standard in MFW White, see premium Metal Finish for options
- Hardwire infeed and jumpers are included in workstations
- T75 worksurface wire cutout is standard on all worksurfaces.(T75D: Delete cutout is optional)

[Click Here for Graded in Pricing](#)

2 Select Finish

Click to view finishes	WWP	WOW
	PO01	WNO
	PO02	WSO
	PO03	WNF(Natural Oak on Flat Cut)
	PO07	WSF(Salted Oak on Flat Cut)
	PO08	WSF(Salted Oak on Flat Cut)
	PO09	WSF(Salted Oak on Flat Cut)
	WBW	
	WSW	
	WEC	

GEC	LW04
GNA +5%	LW05
GWL	LW06
LP01	
LF02	
LF03	
LN01	
LA02	
LW01	
LW02	

MOC	
MEC	
MSW	
MTW	
MWL	
MNA	

3 Select Feet Finish

Click to view edges	WWP	WOW
	PO01	WNO
	PO02	WSO
	PO03	
	PO07	
	PO08	
	PO09	
	WBW	
	WSW	
	WEC	

WWP	WOW
PO01	WNO
PO02	WSO
PO03	
PO07	
PO08	
PO09	
WBW	
WSW	
WEC	

WWP	WOW
PO01	WNO
PO02	WSO
PO03	
PO07	
PO08	
PO09	
WEC	
WBW	
WSW	

4 Select Edge

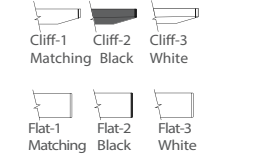
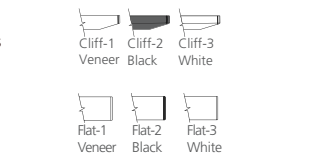

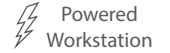
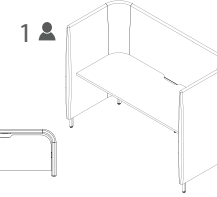
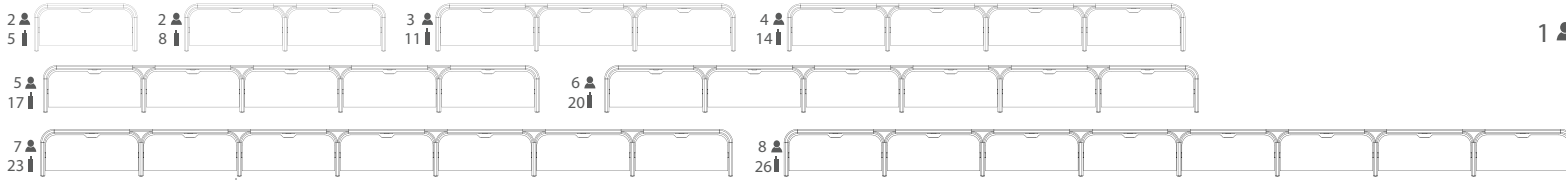

Number of Feet per Typical (MTL10 Option)

1 Select Model

Weight

Standard Veneer Top Upholstered Panels - COM\$

Premium Veneer Top Upholstered Panels - COM\$

High Pressure Laminate Top Upholstered Panels - COM\$

Thermally Fused Laminate Top Upholstered Panels - COM\$

w" x d" x h"	Weight	Standard Veneer Top Upholstered Panels - COM\$
563 x 34 x 55	8	42542
490 x 34 x 55	7	37414
421 x 34 x 55	6	32286
351 x 34 x 55	5	27158
282 x 34 x 55	4	22030
212 x 34 x 55	3	16902
143 x 34 x 55	2	11774
73 x 34 x 55	1	6646

"P" Option N/A
"P" Option N/A
"P" Option N/A
"P" Option N/A
"P" Option N/A
"P" Option N/A
"P" Option N/A
"P" Option N/A
"P" Option N/A

HNY56334FP553G 40942
HNY49034FP553G 36014
HNY42134FP553G 31086
HNY35134FP553G 26158
HNY28234FP553G 21230
HNY21234FP553G 16302
HNY14334FP553G 11374
HNY7334FP553G 6446

HNY56334FP553M 37886
HNY49034FP553M 33340
HNY42134FP553M 28794
HNY35134FP553M 24248
HNY28234FP553M 19702
HNY21234FP553M 15156
HNY14334FP553M 10610
HNY7334FP553M 6064

[Click here to view statement of line](#)

Product Features

- HNY6625WT162 Fixed Desk Height Worksurfaces are included
- 5" Solid wood feet - oval shape
- 4 Power outlets with 1 telecom plate, see options below for telecom plate
- Ships KD
- Wire management tray attaches to worksurface top, standard in MFW White, see premium Metal Finish for options
- Hardwire infeed and jumpers are included in workstations
- T75 worksurface wire cutout is standard on all worksurfaces.(T75D: Delete cutout is optional)

[Click Here for Graded in Pricing](#)

2 Select Finish

Click to view finishes

WWP	WOW
PO01	WNO
PO02	WSO
PO03	WNF(Natural Oak on Flat Cut)
PO07	WSF(Salted Oak on Flat Cut)
PO08	WSF(Salted Oak on Flat Cut)
PO09	WSF(Salted Oak on Flat Cut)
WBW	
WSW	
WEC	

3 Select Feet Finish

Click to view edges

WWP	WOW
PO01	WNO
PO02	WSO
PO03	
PO07	
PO08	
PO09	
WBW	
WSW	
WEC	

GEC LW04
GNA +5% LW05
GWL LW06
LP01
LF02
LF03
LN01
LA02
LW01
LW02

MOC
MEC
MSW
MTW
MWL
MNA

4 Select Edge

Click to view details

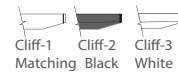

Options

Accessories

- K28: Articulating Keyboard w/ Mouse - \$390
- K31-SK: Center drawer w/ skirt - \$310
- K31: Center drawer w/o skirt - \$205

Concealed Floor Power Infeed Cover

- PCEB: White Metal Finish concealed floor power infeed cover - \$150

Delete Top and Wire Tray

- DFP: Delete fixed top. Deduct \$1535 Veneer (W), \$1335 High Pressure Laminate (G), \$953 Thermally Fused Laminate (M) per top

Metal Feet

- MTL10: Replace solid wood feet with metal feet, standard MFW White - \$55 ea

Premium Metal Finish

- Specify premium Metal Finish. MFMB: Matte Black, MFS: Silver, MFSS: Salmon Sienna, MFSA: Surfing Aquavert, MFPS: Pistachio, MFOS: Oyster, MFNA: Navy, MFOL: Olive, MFGB: Grey Beige MFGG: Graphite Gray, MFG: Gray, MFGM: Matte Gold
- Premium Metal Finish for WMT Wire Management Tray - \$75 ea
- Premium Metal Finish for MTL10 Metal Feet - \$20 ea
- Premium Metal Finish for PCEB Concealed Floor Power Infeed Cover - \$35

Telecom Plates

- Each power unit has 1 plate. All telecom connectors sold separately.
- RJ45 (1) - \$55, RJ45 (2) - \$110, RJ45 (3) - \$165, USB (1) - \$70, USB (2) - \$140, RJ45/USB - \$125, RJ45/HDMI - \$210, HDMI/USB - \$205

Worksurface Height

- THL-42: Modify worksurface height to bar height - N/C

**DARRAN**

**Honey**

Inline 90° Workstation Typical  
Position 1 Desk with Fixed Worksurface

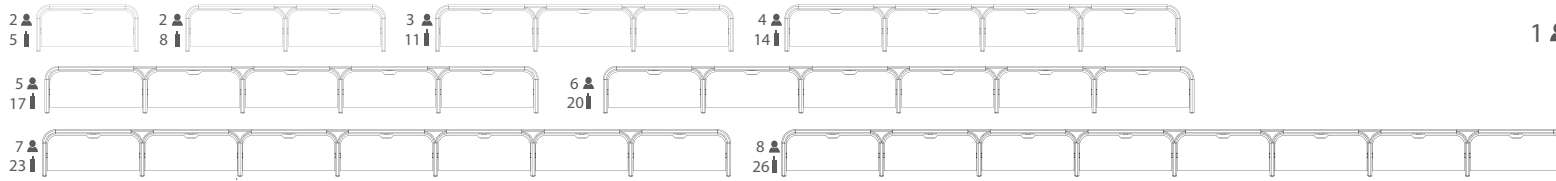

Number of Feet per Typical (MTL10 Option)



**1 Select Model**

Weight

Standard Veneer Top Upholstered Panels - COM\$

Premium Veneer Top Upholstered Panels - COM\$

High Pressure Laminate Top Upholstered Panels - COM\$

Thermally Fused Laminate Top Upholstered Panels - COM\$

**Product Features**

- HNY6625WT162 Fixed Desk Height Worksurfaces are included
- 5" Solid wood feet - oval shape
- Ships KD
- T75 worksurface wire cutout is standard on all worksurfaces.(T75D: Delete cutout is optional)

w" x d" x h"	Weight	Standard Veneer Top Upholstered Panels - COM\$
563 x 34 x 55	8	HNY56334FT553W 36928
490 x 34 x 55	7	HNY49034FT553W 32478
421 x 34 x 55	6	HNY42134FT553W 28028
351 x 34 x 55	5	HNY35134FT553W 23578
282 x 34 x 55	4	HNY28234FT553W 19128
212 x 34 x 55	3	HNY21234FT553W 14678
143 x 34 x 55	2	HNY14334FT553W 10228
73 x 34 x 55	1	HNY7334FT553W 5778

"P" Option N/A
"P" Option N/A
"P" Option N/A
"P" Option N/A
"P" Option N/A
"P" Option N/A
"P" Option N/A
"P" Option N/A

HNY56334FT553G 35328
HNY49034FT553G 31078
HNY42134FT553G 26828
HNY35134FT553G 22578
HNY28234FT553G 18328
HNY21234FT553G 14078
HNY14334FT553G 9828
HNY7334FT553G 5578

HNY56334FT553M 32272
HNY49034FT553M 28404
HNY42134FT553M 24536
HNY35134FT553M 20668
HNY28234FT553M 16800
HNY21234FT553M 12932
HNY14334FT553M 9064
HNY7334FT553M 5196

**Options**

**Accessories**

- K28: Articulating Keyboard w/ Mouse - \$390
- K31-SK: Center drawer w/ skirt - \$310
- K31: Center drawer w/o skirt - \$205

**Delete Top**

- DFT: Delete fixed top. Deduct \$1325 Veneer(W), \$1125 High Pressure Laminate (G), \$743 Thermally Fused Laminate (M) per top

**Metal Feet**

- MTL10: Replace solid wood feet with metal feet, standard MFW White - \$55 ea

**Premium Metal Finish**

- Specify premium Metal Finish. MFMB: Matte Black, MFS: Silver, MFSS: Salmon Sienna, MFSA: Surfing Aquavert, MFPS: Pistachio, MFOS: Oyster, MFNA: Navy, MFOL: Olive, MFGB: Grey Beige MFGG: Graphite Gray, MFG: Gray, MFGM: Matte Gold
- Premium Metal Finish for WMT Wire Management Tray - \$75 ea
- Premium Metal Finish for MTL10 Metal Feet - \$20 ea
- Premium Metal Finish for PCEB Concealed Floor Power Infeed Cover - \$35=

**Worksurface Height**

- THL-42: Modify worksurface height to bar height - N/C

**Wire Tray**

- WMT: Wire metal tray. Mounts under top and comes standard in MFW White - \$210

[Click Here for Graded in Pricing](#)

**2 Select Finish**

Click to view finishes

WWP	WOW
PO01	WNO
PO02	WSO
PO03	WNF(Natural Oak on Flat Cut)
PO07	WSF(Salted Oak on Flat Cut)
PO08	WSF(Salted Oak on Flat Cut)
PO09	WSF(Salted Oak on Flat Cut)
WBW	
WSW	
WEC	

GEC	LW04
GNA +5%	LW05
GWL	LW06
LP01	
LF02	
LF03	
LN01	
LA02	
LW01	
LW02	

MOC
MEC
MSW
MTW
MWL
MNA

**3 Select Feet Finish**

Click to view edges

WWP	WOW
PO01	WNO
PO02	WSO
PO03	
PO07	
PO08	
PO09	
WBW	
WSW	
WEC	

WWP	WOW
PO01	WNO
PO02	WSO
PO03	
PO07	
PO08	
PO09	
WBW	
WSW	
WEC	

WWP	WOW
PO01	WNO
PO02	WSO
PO03	
PO07	
PO08	
PO09	
WEC	
WBW	
WSW	

**4 Select Edge**

Click to view details

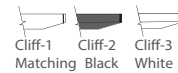
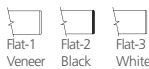

DARRAN<sup>®</sup>

Honey

Inline 90° Workstation Typical  
Position 2 Desk with Height Adjustable Worksurface

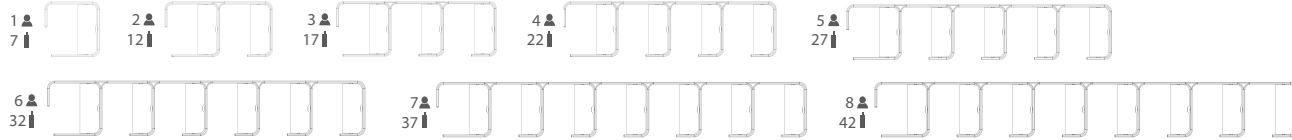

Number of Feet per Typical (MTL10 Option)

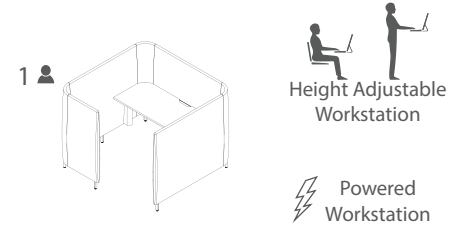

1 Select Model

w" x d" x h"  
560 x 73 x 55  
491 x 73 x 55  
421 x 73 x 55  
352 x 73 x 55  
282 x 73 x 55  
212 x 73 x 55  
143 x 73 x 55  
73 x 73 x 55

Weight

Standard Veneer Top  
Upholstered Panels - COM\$

8	HNY56073HA554W	78135
7	HNY49173HA554W	68598
6	HNY42173HA554W	59061
5	HNY35273HA554W	49524
4	HNY28273HA554W	39987
3	HNY21273HA554W	30450
2	HNY14373HA554W	20913
1	HNY7373HA554W	11376

Premium Veneer Top  
Upholstered Panels - COM\$

"P"	Option N/A
"P"	Option N/A
"P"	Option N/A
"P"	Option N/A
"P"	Option N/A
"P"	Option N/A
"P"	Option N/A
"P"	Option N/A
"P"	Option N/A

High Pressure Laminate Top  
Upholstered Panels - COM\$

HNY56073HA554G	76527
HNY49173HA554G	67191
HNY42173HA554G	57855
HNY35273HA554G	48519
HNY28273HA554G	39183
HNY21273HA554G	29847
HNY14373HA554G	20511
HNY7373HA554G	11175

Thermally Fused Laminate Top  
Upholstered Panels - COM\$

HNY56073HA554M	73471
HNY49173HA554M	64517
HNY42173HA554M	55563
HNY35273HA554M	46609
HNY28273HA554M	37655
HNY21273HA554M	28701
HNY14373HA554M	19747
HNY7373HA554M	10793

[Click here to view statement of line](#)

Product Features

- HNY6625WT163 Height Adjustable worksurfaces are included
- 5" Solid wood feet - oval shape
- 4 Power outlets with 1 telecom plate, see options below for telecom plate
- Ships KD
- Wire management tray attaches to worksurface top, standard in MFW White, see premium Metal Finish for options
- Hardwire infeed and jumpers are included in workstations
- T75 worksurface wire cutout is standard on all worksurfaces.(T75D: Delete cutout is optional)

[Click Here for Graded in Pricing](#)

2 Select Finish

Click to view finishes

WWP	WOW
PO01	WNO
PO02	WSO
PO03	WNF(Natural Oak on Flat Cut)
PO07	WSF(Salted Oak on Flat Cut)
PO08	WSF(Salted Oak on Flat Cut)
PO09	WSF(Salted Oak on Flat Cut)
WBW	
WSW	
WEC	

3 Select Feet Finish

Click to view edges

WWP	WOW
PO01	WNO
PO02	WSO
PO03	
PO07	
PO08	
PO09	
WBW	
WSW	
WEC	

4 Select Edge

Click to view details

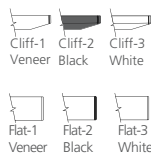

GEC	LW04
GNA +5%	LW05
GWL	LW06
LP01	
LF02	
LF03	
LN01	
LA02	
LW01	
LW02	

WWP	WOW
PO01	WNO
PO02	WSO
PO03	
PO07	
PO08	
PO09	
WBW	
WSW	
WEC	

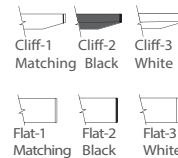

MOC
MEC
MSW
MTW
MWL
MNA

WWP	WOW
PO01	WNO
PO02	WSO
PO03	
PO07	
PO08	
PO09	
WEC	
WBW	
WSW	



Options

Accessories

- K28: Articulating Keyboard w/ Mouse - \$390
- K31-SK: Center drawer w/ skirt - \$310
- K31: Center drawer w/o skirt - \$205

Concealed Floor Power Infeed Cover

- PCEB: White Metal Finish concealed floor power infeed cover - \$150

Delete Top and Wire Tray

- DHAT: Delete height adjustable top. Deduct \$3845 Veneer(W), \$3644 High Pressure Laminate(G), \$3262 Thermally Fused Laminate(M) per top

Metal Feet

- MTL10: Replace solid wood feet with metal feet, standard MFW White - \$55 ea

Premium Metal Finish

- Specify premium Metal Finish. MFMB: Matte Black, MFS: Silver, MFSS: Salmon Sienna, MFSA: SurfIn Aquavert, MFPS: Pistachio, MFOS: Oyster, MFNA: Navy, MFOL: Olive, MFGB: Grey Beige MFGG: Graphite Gray, MFG: Gray, MFGM: Matte Gold
- Premium Metal Finish for WMT Wire Management Tray - \$75 ea
- Premium Metal Finish for MTL10 Metal Feet - \$20 ea
- Premium Metal Finish for PCEB Concealed Floor Power Infeed Cover - \$35

Telecom Plates

- Each power unit has 1 plate. All telecom connectors sold separately.
- RJ45 (1) - \$55, RJ45 (2) - \$110, RJ45 (3) - \$165, USB (1) - \$70, USB (2) - \$140, RJ45/USB - \$125, RJ45/HDMI - \$210, HDMI/USB - \$205

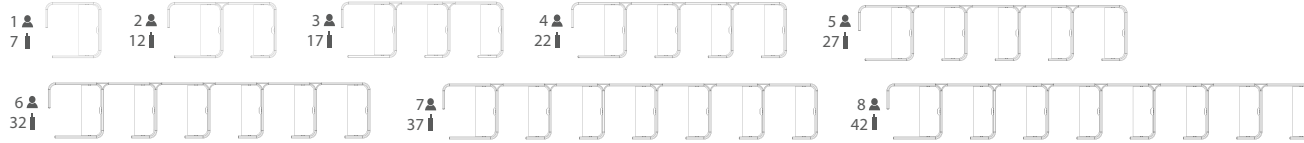

Number of Feet per Typical (MTL10 Option)

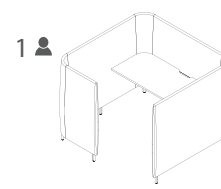

Fixed Top Workstation

Powered Workstation

1 Select Model

w" x d" x h"	Weight	Standard Veneer Top Upholstered Panels - COM\$
560 x 73 x 55	8	HNY56073FP554W 59655
491 x 73 x 55	7	HNY49173FP554W 52428
421 x 73 x 55	6	HNY42173FP554W 45201
351 x 73 x 55	5	HNY35273FP554W 37974
282 x 73 x 55	4	HNY28273FP554W 30747
212 x 73 x 55	3	HNY21273FP554W 23520
143 x 73 x 55	2	HNY14373FP554W 16293
73 x 73 x 55	1	HNY7373FP554W 9066

[Click Here for Graded in Pricing](#)

2 Select Finish

Click to view finishes	WWP	WOW
PO01	WNO	
PO02	WSO	
PO03	WNF(Natural Oak on Flat Cut)	
PO07	WSF(Salted Oak on Flat Cut)	
PO08	WSF(Salted Oak on Flat Cut)	
PO09	WSF(Salted Oak on Flat Cut)	
WBW		
WSW		
WEC		

3 Select Feet Finish

Click to view edges	WWP	WOW
PO01	WNO	
PO02	WSO	
PO03		
PO07		
PO08		
PO09		
WBW		
WSW		
WEC		

4 Select Edge

Click to view details

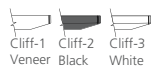

Premium Veneer Top Upholstered Panels - COM\$

"P" Option N/A
"P" Option N/A
"P" Option N/A
"P" Option N/A
"P" Option N/A
"P" Option N/A
"P" Option N/A
"P" Option N/A
"P" Option N/A
"P" Option N/A

High Pressure Laminate Top Upholstered Panels - COM\$

HNY56073FP554G 58055
HNY49173FP554G 51028
HNY42173FP554G 44001
HNY35273FP554G 36974
HNY28273FP554G 29947
HNY21273FP554G 22920
HNY14373FP554G 15893
HNY7373FP554G 8866

GEC LW04
GNA +5% LW05
GWL LW06
LP01
LF02
LF03
LN01
LA02
LW01
LW02

WWP WOW
PO01 WNO
PO02 WSO
PO03
PO07
PO08
PO09
WBW
WSW
WEC



Thermally Fused Laminate Top Upholstered Panels - COM\$

HNY56073FP554M 54999
HNY49173FP554M 48354
HNY42173FP554M 41709
HNY35273FP554M 35064
HNY28273FP554M 28419
HNY21273FP554M 21774
HNY14373FP554M 15129
HNY7373FP554M 8484

MOC
MEC
MSW
MTW
MWL
MNA

WWP WOW
PO01 WNO
PO02 WSO
PO03
PO07
PO08
PO09
WEC
WBW
WSW



[Click here to view statement of line](#)

Product Features

- HNY6625WT162 Fixed Desk Height Worksurfaces are included
- 5" Solid wood feet - oval shape
- 4 Power outlets with 1 telecom plate, see options below for telecom plate
- Ships KD
- Wire management tray attaches to worksurface top, standard in MFW White, see premium Metal Finish for options
- Hardwire infeed and jumpers are included in workstations
- T75 worksurface wire cutout is standard on all worksurfaces.(T75D: Delete cutout is optional)

Options

Accessories

- K28: Articulating Keyboard w/ Mouse - \$390
- K31-SK: Center drawer w/ skirt - \$310
- K31: Center drawer w/o skirt - \$205

Concealed Floor Power Infeed Cover

- PCEB: White Metal Finish concealed floor power infeed cover - \$150

Delete Top and Wire Tray

- DFP: Delete fixed top. Deduct \$1535 Veneer (W), \$1335 High Pressure Laminate (G), \$953 Thermally Fused Laminate (M) per top

Metal Feet

- MTL10: Replace solid wood feet with metal feet, standard MFW White - \$55 ea

Premium Metal Finish

- Specify premium Metal Finish. MFMB: Matte Black, MFS: Silver, MFSS: Salmon Sienna, MFSA: SurfIn Aquavert, MFPS: Pistachio, MFOS: Oyster, MFNA: Navy, MFOL: Olive, MFGB: Grey Beige MFGG: Graphite Gray, MFG: Gray, MFGM: Matte Gold
- Premium Metal Finish for WMT Wire Management Tray - \$75 ea
- Premium Metal Finish for MTL10 Metal Feet - \$20 ea
- Premium Metal Finish for PCEB Concealed Floor Power Infeed Cover - \$35

Telecom Plates

- Each power unit has 1 plate. All telecom connectors sold separately.
- RJ45 (1) - \$55, RJ45 (2) - \$110, RJ45 (3) - \$165, USB (1) - \$70, USB (2) - \$140, RJ45/USB - \$125, RJ45/HDMI - \$210, HDMI/USB - \$205

Worksurface Height

- THL-42: Modify worksurface height to bar height - N/C

DARRAN

Honey

Inline 90° Workstation Typical  
Position 2 Desk with Fixed Worksurface

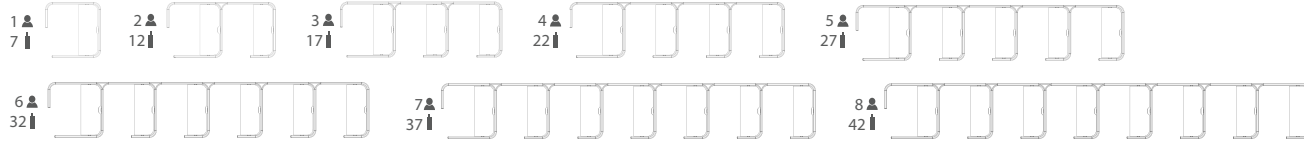

Number of Feet per Typical (MTL10 Option)

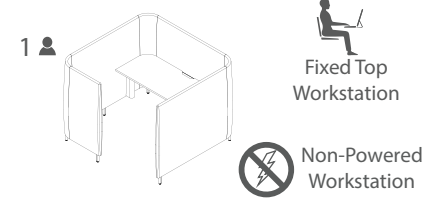

1 Select Model

Weight

Standard Veneer Top Upholstered Panels - COM\$

Premium Veneer Top Upholstered Panels - COM\$

High Pressure Laminate Top Upholstered Panels - COM\$

Thermally Fused Laminate Top Upholstered Panels - COM\$

560 x 73 x 55	8	HNY56073FT554W	52887
491 x 73 x 55	7	HNY49173FT554W	46496
421 x 73 x 55	6	HNY42173FT554W	40105
352 x 73 x 55	5	HNY35273FT554W	33714
282 x 73 x 55	4	HNY28273FT554W	27323
212 x 73 x 55	3	HNY21273FT554W	20932
143 x 73 x 55	2	HNY14373FT554W	14541
73 x 73 x 55	1	HNY7373FT554W	8150

"P" Option N/A  
 "P" Option N/A  
 "P" Option N/A  
 "P" Option N/A  
 "P" Option N/A  
 "P" Option N/A  
 "P" Option N/A  
 "P" Option N/A

HNY56073FT554G	51287
HNY49173FT554G	45096
HNY42173FT554G	38905
HNY35273FT554G	32714
HNY28273FT554G	26523
HNY21273FT554G	20332
HNY14373FT554G	14141
HNY7373FT554G	7950

HNY56073FT554M	48231
HNY49173FT554M	42422
HNY42173FT554M	36613
HNY35273FT554M	30804
HNY28273FT554M	24995
HNY21273FT554M	19186
HNY14373FT554M	13377
HNY7373FT554M	7568

[Click here to view statement of line](#)

Product Features

- HNY6625WT162 Fixed Desk Height Worksurfaces are included
- 5" Solid wood feet - oval shape
- Ships KD
- T75 worksurface wire cutout is standard on all worksurfaces.(T75D: Delete cutout is optional)

Options

Accessories

- K28: Articulating Keyboard w/ Mouse - \$390
- K31-SK: Center drawer w/ skirt - \$310
- K31: Center drawer w/o skirt - \$205

Delete Top

- DFT: Delete fixed top. Deduct \$1325 Veneer(W), \$1125 High Pressure Laminate (G), \$743 Thermally Fused Laminate (M) per top

Metal Feet

- MTL10: Replace solid wood feet with metal feet, standard MFW White - \$55 ea

Premium Metal Finish

- Specify premium Metal Finish. MFMB: Matte Black, MFS: Silver, MFSS: Salmon Sienna, MFSA: Surfing Aquavert, MFPS: Pistachio, MFOS: Oyster, MFNA: Navy, MFOL: Olive, MFGB: Grey Beige MFGG: Graphite Gray, MFG: Gray, MFGM: Matte Gold
- Premium Metal Finish for WMT Wire Management Tray - \$75 ea
- Premium Metal Finish for MTL10 Metal Feet - \$20 ea
- Premium Metal Finish for PCEB Concealed Floor Power Infeed Cover - \$35

Worksurface Height

- THL-42: Modify worksurface height to bar height - N/C

Wire Tray

- WMT: Wire metal tray. Mounts under top and comes standard in MFW White - \$210

[Click Here for Graded in Pricing](#)

2 Select Finish

Click to view finishes

WWP	WOW
PO01	WNO
PO02	WSO
PO03	WNF(Natural Oak on Flat Cut)
PO07	WSF(Salted Oak on Flat Cut)
PO08	WSF(Salted Oak on Flat Cut)
PO09	WSF(Salted Oak on Flat Cut)
WBW	
WSW	
WEC	

GEC	LW04
GNA +5%	LW05
GWL	LW06
LP01	
LF02	
LF03	
LN01	
LA02	
LW01	
LW02	

MOC
MEC
MSW
MTW
MWL
MNA

3 Select Feet Finish

Click to view edges

WWP	WOW
PO01	WNO
PO02	WSO
PO03	
PO07	
PO08	
PO09	
WBW	
WSW	
WEC	

WWP	WOW
PO01	WNO
PO02	WSO
PO03	
PO07	
PO08	
PO09	
WBW	
WSW	
WEC	

WWP	WOW
PO01	WNO
PO02	WSO
PO03	
PO07	
PO08	
PO09	
WEC	
WBW	
WSW	

4 Select Edge

Click to view details

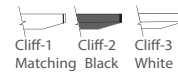
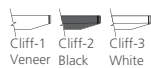



DARRAN

Honey

Inline 90° Workstation Typical  
Position 3 Desk with Height Adjustable Worksurface

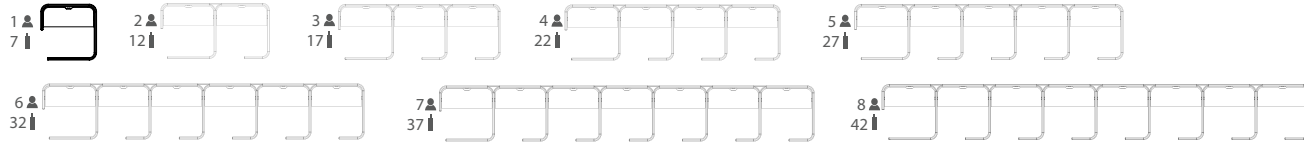

Number of Feet per Typical (MTL10 Option)

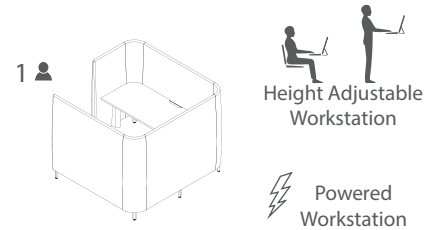

1 Select Model

Weight

Standard Veneer Top Upholstered Panels - COM\$

Premium Veneer Top Upholstered Panels - COM\$

High Pressure Laminate Top Upholstered Panels - COM\$

Thermally Fused Laminate Top Upholstered Panels - COM\$

w" x d" x h"	Standard Veneer Top Upholstered Panels - COM\$	Premium Veneer Top Upholstered Panels - COM\$
560 x 73 x 55	8 HNY56073HA555W 77365	"P" Option N/A
491 x 73 x 55	7 HNY49173HA555W 67938	"P" Option N/A
421 x 73 x 55	6 HNY42173HA555W 58511	"P" Option N/A
352 X 73 X 55	5 HNY35273HA555W 49084	"P" Option N/A
282 x 73 x 55	4 HNY28273HA555W 39657	"P" Option N/A
212 x 73 x 55	3 HNY21273HA555W 30230	"P" Option N/A
143 x 73 x 55	2 HNY14373HA555W 20803	"P" Option N/A
73 x 73 x 55	1 HNY7373HA555W 11376	"P" Option N/A

[Click Here for Graded in Pricing](#)

2 Select Finish

Click to view finishes

WWP	WOW
PO01	WNO
PO02	WSO
PO03	WNF(Natural Oak on Flat Cut)
PO07	WSF(Salted Oak on Flat Cut)
PO08	WSF(Salted Oak on Flat Cut)
PO09	WSF(Salted Oak on Flat Cut)
WBW	
WSW	
WEC	

3 Select Feet Finish

Click to view edges

WWP	WOW
PO01	WNO
PO02	WSO
PO03	
PO07	
PO08	
PO09	
WBW	
WSW	
WEC	

4 Select Edge

Click to view details

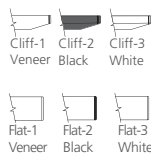

GEC	LW04
GNA +5%	LW05
GWL	LW06
LP01	
LF02	
LF03	
LN01	
LA02	
LW01	
LW02	

WWP	WOW
PO01	WNO
PO02	WSO
PO03	
PO07	
PO08	
PO09	
WBW	
WSW	
WEC	

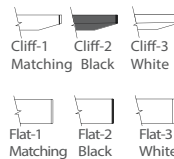

MOC
MEC
MSW
MTW
MWL
MNA

WWP	WOW
PO01	WNO
PO02	WSO
PO03	
PO07	
PO08	
PO09	
WEC	
WBW	
WSW	



[Click here to view statement of line](#)

Product Features

- HNY6625WT163 Height Adjustable worksurfaces are included
- 5" Solid wood feet - oval shape
- 4 Power outlets with 1 telecom plate, see options below for telecom plate
- Ships KD
- Wire management tray attaches to worksurface top, standard in MFW White, see premium Metal Finish for options
- Hardwire infeed and jumpers are included in workstations
- T75 worksurface wire cutout is standard on all worksurfaces.(T75D: Delete cutout is optional)

Options

Accessories

- K28: Articulating Keyboard w/ Mouse - \$390
- K31-SK: Center drawer w/ skirt - \$310
- K31: Center drawer w/o skirt - \$205

Concealed Floor Power Infeed Cover

- PCEB: White Metal Finish concealed floor power infeed cover - \$150

Delete Top and Wire Tray

- DHAT: Delete height adjustable top. Deduct \$3845 Veneer(W), \$3644 High Pressure Laminate(G), \$3262 Thermally Fused Laminate(M) per top

Metal Feet

- MTL10: Replace solid wood feet with metal feet, standard MFW White - \$55 ea

Premium Metal Finish

- Specify premium Metal Finish. MFMB: Matte Black, MFS: Silver, MFSS: Salmon Sienna, MFSA: SurfIn Aquavert, MFPS: Pistachio, MFOS: Oyster, MFNA: Navy, MFOL: Olive, MFGB: Grey Beige MFGG: Graphite Gray, MFG: Gray, MFGM: Matte Gold
- Premium Metal Finish for WMT Wire Management Tray - \$75 ea
- Premium Metal Finish for MTL10 Metal Feet - \$20 ea
- Premium Metal Finish for PCEB Concealed Floor Power Infeed Cover - \$35

Telecom Plates

- Each power unit has 1 plate. All telecom connectors sold separately.
- RJ45 (1) - \$55, RJ45 (2) - \$110, RJ45 (3) - \$165, USB (1) - \$70, USB (2) - \$140, RJ45/USB - \$125, RJ45/HDMI - \$210, HDMI/USB - \$205

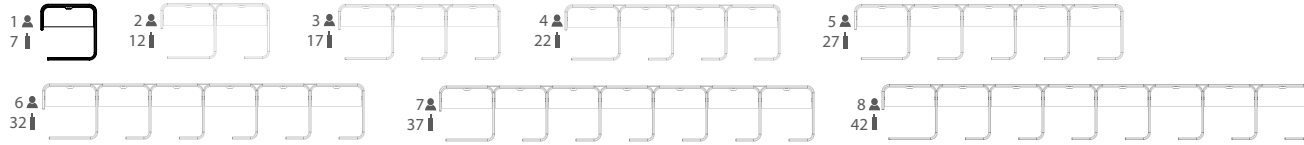

Number of Feet per Typical (MTL10 Option)

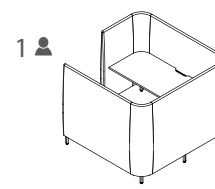

Fixed Top Workstation

Powered Workstation

1 Select Model

Weight

Standard Veneer Top Upholstered Panels - COM\$

Premium Veneer Top Upholstered Panels - COM\$

High Pressure Laminate Top Upholstered Panels - COM\$

Thermally Fused Laminate Top Upholstered Panels - COM\$

560 x 73 x 55	8	HNY56073FP555W	58885
491 x 73 x 55	7	HNY49173FP555W	51768
421 x 73 x 55	6	HNY42173FP555W	44651
352 x 73 x 55	5	HNY35273FP555W	37534
282 x 73 x 55	4	HNY28273FP555W	30417
212 x 73 x 55	3	HNY21273FP555W	23300
143 x 73 x 55	2	HNY14373FP555W	16183
73 x 73 x 55	1	HNY7373FP555W	9066

"P" Option N/A  
"P" Option N/A  
"P" Option N/A  
"P" Option N/A  
"P" Option N/A  
"P" Option N/A  
"P" Option N/A  
"P" Option N/A

HNY56073FP555G	57285
HNY49173FP555G	50368
HNY42173FP555G	43451
HNY35273FP555G	36534
HNY28273FP555G	29617
HNY21273FP555G	22700
HNY14373FP555G	15783
HNY7373FP555G	8866

HNY56073FP555M	54229
HNY49173FP555M	43660
HNY42173FP555M	41159
HNY35273FP555M	34624
HNY28273FP555M	28089
HNY21273FP555M	21554
HNY14373FP555M	15019
HNY7373FP555M	8484

[Click here to view statement of line](#)

Product Features

- HNY6625WT162 Fixed Desk Height Worksurfaces are included
- 5" Solid wood feet - oval shape
- 4 Power outlets with 1 telecom plate, see options below for telecom plate
- Ships KD
- Wire management tray attaches to worksurface top, standard in MFW White, see premium Metal Finish for options
- Hardwire infeed and jumpers are included in workstations
- T75 worksurface wire cutout is standard on all worksurfaces.(T75D: Delete cutout is optional)

[Click Here for Graded in Pricing](#)

2 Select Finish

Click to view finishes

WWP	WOW
PO01	WNO
PO02	WSO
PO03	WNF(Natural Oak on Flat Cut)
PO07	WSF(Salted Oak on Flat Cut)
PO08	WSF(Salted Oak on Flat Cut)
PO09	WSF(Salted Oak on Flat Cut)
WBW	
WSW	
WEC	

GEC	LW04
GNA +5%	LW05
GWL	LW06
LP01	
LF02	
LF03	
LN01	
LA02	
LW01	
LW02	

MOC
MEC
MSW
MTW
MWL
MNA

3 Select Feet Finish

Click to view edges

WWP	WOW
PO01	WNO
PO02	WSO
PO03	
PO07	
PO08	
PO09	
WBW	
WSW	
WEC	

WWP	WOW
PO01	WNO
PO02	WSO
PO03	
PO07	
PO08	
PO09	
WBW	
WSW	
WEC	

WWP	WOW
PO01	WNO
PO02	WSO
PO03	
PO07	
PO08	
PO09	
WEC	
WBW	
WSW	

4 Select Edge

Click to view details

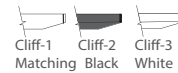
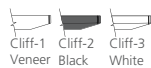

Options

Accessories

- K28: Articulating Keyboard w/ Mouse - \$390
- K31-SK: Center drawer w/ skirt - \$310
- K31: Center drawer w/o skirt - \$205

Concealed Floor Power Infeed Cover

- PCEB: White Metal Finish concealed floor power infeed cover - \$150

Delete Top and Wire Tray

- DFP: Delete fixed top. Deduct \$1535 Veneer (W), \$1335 High Pressure Laminate (G), \$953 Thermally Fused Laminate (M) per top

Metal Feet

- MTL10: Replace solid wood feet with metal feet, standard MFW White - \$55 ea

Premium Metal Finish

- Specify premium Metal Finish. MFMB: Matte Black, MFS: Silver, MFSS: Salmon Sienna, MFSA: SurfIn Aquavert, MFPS: Pistachio, MFOS: Oyster, MFNA: Navy, MFOL: Olive, MFGB: Grey Beige MFGG: Graphite Gray, MFG: Gray, MFGM: Matte Gold
- Premium Metal Finish for WMT Wire Management Tray - \$75 ea
- Premium Metal Finish for MTL10 Metal Feet - \$20 ea
- Premium Metal Finish for PCEB Concealed Floor Power Infeed Cover - \$35

Telecom Plates

- Each power unit has 1 plate. All telecom connectors sold separately.
- RJ45 (1) - \$55, RJ45 (2) - \$110, RJ45 (3) - \$165, USB (1) - \$70, USB (2) - \$140, RJ45/USB - \$125, RJ45/HDMI - \$210, HDMI/USB - \$205

Worksurface Height

- THL-42: Modify worksurface height to bar height - N/C

DARRAN

Honey

Inline 90° Workstation Typical  
Position 3 Desk with Fixed Worksurface

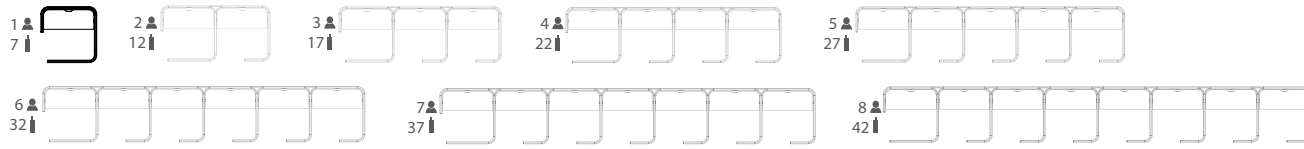

Number of Feet per Typical (MTL10 Option)

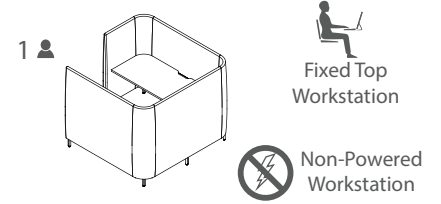

1 Select Model

Weight

Standard Veneer Top Upholstered Panels - COM\$

Premium Veneer Top Upholstered Panels - COM\$

High Pressure Laminate Top Upholstered Panels - COM\$

Thermally Fused Laminate Top Upholstered Panels - COM\$

560 x 73 x 55	8	HNYS6073FT555W	52887
491 x 73 x 55	7	HNYS49173FT555W	46496
421 x 73 x 55	6	HNYS42173FT555W	40105
352 x 73 x 55	5	HNYS35273FT555W	33714
282 x 73 x 55	4	HNYS28273FT555W	27323
212 x 73 x 55	3	HNYS21273FT555W	20932
143 x 73 x 55	2	HNYS14373FT555W	14541
73 x 73 x 55	1	HNYS7373FT555W	8150

"P" Option N/A  
 "P" Option N/A  
 "P" Option N/A  
 "P" Option N/A  
 "P" Option N/A  
 "P" Option N/A  
 "P" Option N/A  
 "P" Option N/A

HNYS6073FT555G	51287
HNYS49173FT555G	45096
HNYS42173FT555G	38905
HNYS35273FT555G	32714
HNYS28273FT555G	26523
HNYS21273FT555G	20332
HNYS14373FT555G	14141
HNYS7373FT555G	7950

HNYS6073FT555M	48231
HNYS49173FP555M	47694
HNYS42173FT555M	36613
HNYS35273FT555M	30804
HNYS28273FT555M	24995
HNYS21273FT555M	19186
HNYS14373FT555M	13377
HNYS7373FT555M	7568

Click here to view statement of line

Product Features

- HNY6625WT162 Fixed Desk Height Worksurfaces are included
- 5" Solid wood feet - oval shape
- Ships KD
- T75 worksurface wire cutout is standard on all worksurfaces.(T75D: Delete cutout is optional)

Options

Accessories

- K28: Articulating Keyboard w/ Mouse - \$390
- K31-SK: Center drawer w/ skirt - \$310
- K31: Center drawer w/o skirt - \$205

Delete Top

- DFT: Delete fixed top. Deduct \$1325 Veneer(W), \$1125 High Pressure Laminate (G), \$743 Thermally Fused Laminate (M) per top

Metal Feet

- MTL10: Replace solid wood feet with metal feet, standard MFW White - \$55 ea

Premium Metal Finish

- Specify premium Metal Finish. MFMB: Matte Black, MFS: Silver, MFSS: Salmon Sienna, MFSA: Surfing Aquavert, MFPS: Pistachio, MFOS: Oyster, MFNA: Navy, MFOL: Olive, MFGB: Grey Beige MFGG: Graphite Gray, MFG: Gray, MFGM: Matte Gold
- Premium Metal Finish for WMT Wire Management Tray - \$75 ea
- Premium Metal Finish for MTL10 Metal Feet - \$20 ea
- Premium Metal Finish for PCEB Concealed Floor Power Infeed Cover - \$35

Worksurface Height

- THL-42: Modify worksurface height to bar height - N/C

Wire Tray

- WMT: Wire metal tray. Mounts under top and comes standard in MFW White - \$210

Click Here for Graded in Pricing

2 Select Finish

Click to view finishes

WWP	WOW
PO01	WNO
PO02	WSO
PO03	WNF(Natural Oak on Flat Cut)
PO07	WSF(Salted Oak on Flat Cut)
PO08	WSF(Salted Oak on Flat Cut)
PO09	WSF(Salted Oak on Flat Cut)
WBW	
WSW	
WEC	

GEC	LW04
GNA +5%	LW05
GWL	LW06
LP01	
LF02	
LF03	
LN01	
LA02	
LW01	
LW02	

MOC
MEC
MSW
MTW
MWL
MNA

3 Select Feet Finish

Click to view edges

WWP	WOW
PO01	WNO
PO02	WSO
PO03	
PO07	
PO08	
PO09	
WBW	
WSW	
WEC	

WWP	WOW
PO01	WNO
PO02	WSO
PO03	
PO07	
PO08	
PO09	
WBW	
WSW	
WEC	

WWP	WOW
PO01	WNO
PO02	WSO
PO03	
PO07	
PO08	
PO09	
WEC	
WBW	
WSW	

4 Select Edge

Click to view details

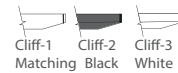
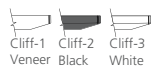

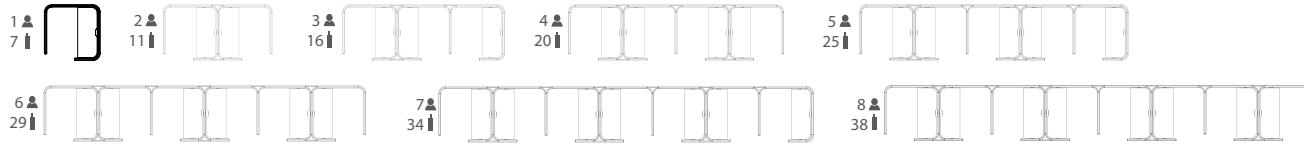

Number of Feet per Typical (MTL10 Option)

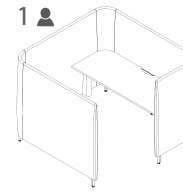

Height Adjustable Workstation

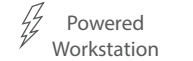

Powered Workstation

1 Select Model

Weight

Standard Veneer Top Upholstered Panels - COM\$

Premium Veneer Top Upholstered Panels - COM\$

High Pressure Laminate Top Upholstered Panels - COM\$

Thermally Fused Laminate Top Upholstered Panels - COM\$

1 person 71"	2 people 111"	3 people 161"	4 people 201"	5 people 251"	6 people 291"	7 people 341"	8 people 381"
560 x 73 x 55	491 x 73 x 55	421 x 73 x 55	352 X 73 x 55	282 x 73 x 55	212 x 73 x 55	143 x 73 x 55	73 x 73 x 55
8 people HNY56073HA556W	7 people HNY49173HA556W	6 people HNY42173HA556W	5 people HNY35273HA556W	4 people HNY28273HA556W	3 people HNY21273HA556W	2 people HNY14373HA556W	1 person HNY7373HA555W
74025	65583	55956	47514	37887	29445	19818	11376

"P" Option N/A  
"P" Option N/A  
"P" Option N/A  
"P" Option N/A  
"P" Option N/A  
"P" Option N/A  
"P" Option N/A  
"P" Option N/A

HNY56073HA556G	72417
HNY49173HA556G	64176
HNY42173HA556G	54750
HNY35273HA556G	46509
HNY28273HA556G	37083
HNY21273HA556G	28842
HNY14373HA556G	19416
HNY7373HA556G	11175

HNY56073HA556M	69361
HNY49173HA556M	61502
HNY42173HA556M	52458
HNY35273HA556M	44599
HNY28273HA556M	35555
HNY21273HA556M	27696
HNY14373HA556M	18652
HNY7373HA556M	10793

[Click here to view statement of line](#)

Product Features

- HNY6625WT163 Height Adjustable worksurfaces are included
- 5" Solid wood feet - oval shape
- 4 Power outlets with 1 telecom plate, see options below for telecom plate
- Ships KD
- Wire management tray attaches to worksurface top, standard in MFW White, see premium Metal Finish for options
- Hardwire infeed and jumpers are included in workstations
- T75 worksurface wire cutout is standard on all worksurfaces.(T75D: Delete cutout is optional)

[Click Here for Graded in Pricing](#)

2 Select Finish

Click to view finishes

WWP	WOW
PO01	WNO
PO02	WSO
PO03	WNF(Natural Oak on Flat Cut)
PO07	WSF(Salted Oak on Flat Cut)
PO08	WSF(Salted Oak on Flat Cut)
PO09	
WBW	
WSW	
WEC	

GEC	LW04
GNA +5%	LW05
GWL	LW06
LP01	
LF02	
LF03	
LN01	
LA02	
LW01	
LW02	

MOC
MEC
MSW
MTW
MWL
MNA

3 Select Feet Finish

Click to view edges

WWP	WOW
PO01	WNO
PO02	WSO
PO03	
PO07	
PO08	
PO09	
WBW	
WSW	
WEC	

WWP	WOW
PO01	WNO
PO02	WSO
PO03	
PO07	
PO08	
PO09	
WBW	
WSW	
WEC	

WWP	WOW
PO01	WNO
PO02	WSO
PO03	
PO07	
PO08	
PO09	
WEC	
WBW	
WSW	

4 Select Edge

Click to view details

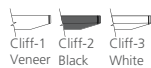

Options

Accessories

- K28: Articulating Keyboard w/ Mouse - \$390
- K31-SK: Center drawer w/ skirt - \$310
- K31: Center drawer w/o skirt - \$205

Concealed Floor Power Infeed Cover

- PCEB: White Metal Finish concealed floor power infeed cover - \$150

Delete Top and Wire Tray

- DHAT: Delete height adjustable top. Deduct \$3845 Veneer(W), \$3644 High Pressure Laminate(G), \$3262 Thermally Fused Laminate(M) per top

Metal Feet

- MTL10: Replace solid wood feet with metal feet, standard MFW White - \$55 ea

Premium Metal Finish

- Specify premium Metal Finish. MFMB: Matte Black, MFS: Silver, MFSS: Salmon Sienna, MFSA: SurfIn Aquavert, MFPS: Pistachio, MFOS: Oyster, MFNA: Navy, MFOL: Olive, MFGB: Grey Beige MFGG: Graphite Gray, MFG: Gray, MFGM: Matte Gold
- Premium Metal Finish for WMT Wire Management Tray - \$75 ea
- Premium Metal Finish for MTL10 Metal Feet - \$20 ea
- Premium Metal Finish for PCEB Concealed Floor Power Infeed Cover - \$35

Telecom Plates

- Each power unit has 1 plate. All telecom connectors sold separately.
- RJ45 (1) - \$55, RJ45 (2) - \$110, RJ45 (3) - \$165, USB (1) - \$70, USB (2) - \$140, RJ45/USB - \$125, RJ45/HDMI - \$210, HDMI/USB - \$205

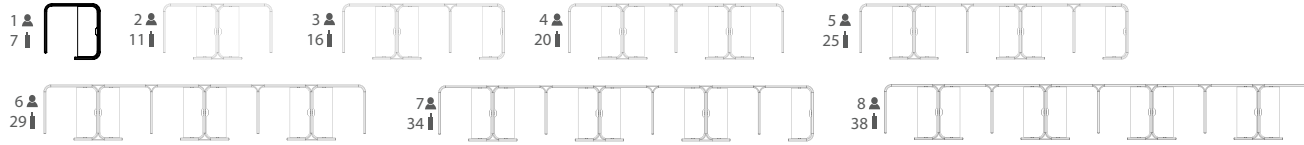

Number of Feet per Typical (MTL10 Option)

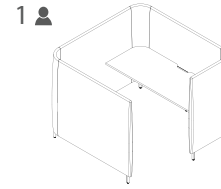

Fixed Top Workstation

Powered Workstation

1 Select Model

Weight

w" x d" x h"
560 x 73 x 55
491 x 73 x 55
421 x 73 x 55
352 x 73 x 55
282 x 73 x 55
212 x 73 x 55
143 x 73 x 55
73 x 73 x 55

Standard Veneer Top Upholstered Panels - COM\$
8 HNY56073FP556W 55545
7 HNY49173FP556W 49413
6 HNY42173FP556W 42096
5 HNY35273FP556W 35964
4 HNY28273FP556W 28647
3 HNY21273FP556W 22515
2 HNY14373FP556W 15198
1 HNY7373FP556W 9066

Premium Veneer Top Upholstered Panels - COM\$
"P" Option N/A
"P" Option N/A
"P" Option N/A
"P" Option N/A
"P" Option N/A
"P" Option N/A
"P" Option N/A
"P" Option N/A
"P" Option N/A

High Pressure Laminate Top Upholstered Panels - COM\$
HNY56073FP556G 53945
HNY49173FP556G 48013
HNY42173FP556G 40896
HNY35273FP556G 34964
HNY28273FP556G 27847
HNY21273FP556G 21915
HNY14373FP556G 14798
HNY7373FP556G 8866

Thermally Fused Laminate Top Upholstered Panels - COM\$
HNY56073FP556M 50889
HNY49173FP556M 45339
HNY42173FP556M 38604
HNY35273FP556M 33054
HNY28273FP556M 26319
HNY21273FP556M 20769
HNY14373FP556M 14034
HNY7373FP556M 8484

[Click here to view statement of line](#)

Product Features

- HNY6625WT162 Fixed Desk Height Worksurfaces are included
- 5" Solid wood feet - oval shape
- 4 Power outlets with 1 telecom plate, see options below for telecom plate
- Ships KD
- Wire management tray attaches to worksurface top, standard in MFW White, see premium Metal Finish for options
- Hardwire infeed and jumpers are included in workstations
- T75 worksurface wire cutout is standard on all worksurfaces.(T75D: Delete cutout is optional)

[Click Here for Graded in Pricing](#)

2 Select Finish

Click to view finishes

WWP	WOW
PO01	WNO
PO02	WSO
PO03	WNF(Natural Oak on Flat Cut)
PO07	WSF(Salted Oak on Flat Cut)
PO08	WSF(Salted Oak on Flat Cut)
PO09	WSF(Salted Oak on Flat Cut)
WBW	
WSW	
WEC	

3 Select Feet Finish

Click to view edges

WWP	WOW
PO01	WNO
PO02	WSO
PO03	
PO07	
PO08	
PO09	
WBW	
WSW	
WEC	

4 Select Edge

Click to view details

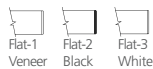

Options

Accessories

- K28: Articulating Keyboard w/ Mouse - \$390
- K31-SK: Center drawer w/ skirt - \$310
- K31: Center drawer w/o skirt - \$205

Concealed Floor Power Infeed Cover

- PCEB: White Metal Finish concealed floor power infeed cover - \$150

Delete Top and Wire Tray

- DFP: Delete fixed top. Deduct \$1535 Veneer (W), \$1335 High Pressure Laminate (G), \$953 Thermally Fused Laminate (M) per top

Metal Feet

- MTL10: Replace solid wood feet with metal feet, standard MFW White - \$55 ea

Premium Metal Finish

- Specify premium Metal Finish. MFMB: Matte Black, MFS: Silver, MFSS: Salmon Sienna, MFSA: SurfIn Aquavert, MFPS: Pistachio, MFOS: Oyster, MFNA: Navy, MFOL: Olive, MFGB: Grey Beige MFGG: Graphite Gray, MFG: Gray, MFGM: Matte Gold
- Premium Metal Finish for WMT Wire Management Tray - \$75 ea
- Premium Metal Finish for MTL10 Metal Feet - \$20 ea
- Premium Metal Finish for PCEB Concealed Floor Power Infeed Cover - \$35

Telecom Plates

- Each power unit has 1 plate. All telecom connectors sold separately.
- RJ45 (1) - \$55, RJ45 (2) - \$110, RJ45 (3) - \$165, USB (1) - \$70, USB (2) - \$140, RJ45/USB - \$125, RJ45/HDMI - \$210, HDMI/USB - \$205

Worksurface Height

- THL-42: Modify worksurface height to bar height - N/C

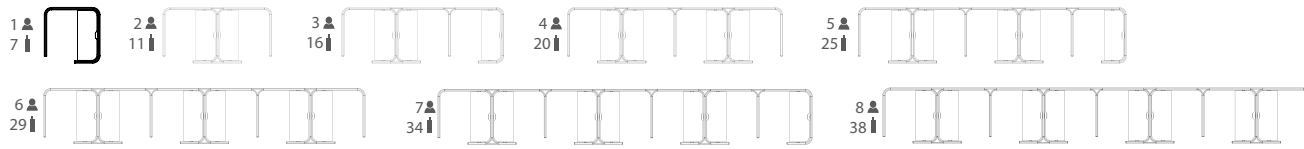

Number of Feet per Typical (MTL10 Option)



1 Select Model

w" x d" x h"	Weight	Standard Veneer Top Upholstered Panels - COM\$
560 x 73 x 55	8	HNY56073FT556W 51583
491 x 73 x 55	7	HNY49173FT556W 45518
421 x 73 x 55	6	HNY42173FT556W 39127
352 x 73 x 55	5	HNY35273FT556W 33062
282 x 73 x 55	4	HNY28273FT556W 26671
212 x 73 x 55	3	HNY21273FT556W 20606
143 x 73 x 55	2	HNY14373FT556W 14215
73 x 73 x 55	1	HNY7373FT556W 8150

2 Select Finish

Click to view finishes	WWP	WOW
	PO01	WNO
	PO02	WSO
	PO03	WNF(Natural Oak on Flat Cut)
	PO08	WSF(Salted Oak on Flat Cut)
	PO09	
	WBW	
	WSW	
	WEC	

3 Select Feet Finish

Click to view edges	WWP	WOW
	PO01	WNO
	PO02	WSO
	PO03	
	PO07	
	PO08	
	PO09	
	WBW	
	WSW	
	WEC	

4 Select Edge

Click to view details



Premium Veneer Top Upholstered Panels - COM\$

"P" Option N/A
"P" Option N/A
"P" Option N/A
"P" Option N/A
"P" Option N/A
"P" Option N/A
"P" Option N/A
"P" Option N/A

High Pressure Laminate Top Upholstered Panels - COM\$

HNY56073FT556G 49983
HNY49173FT556G 44118
HNY42173FT556G 37927
HNY35273FT556G 32062
HNY28273FT556G 25871
HNY21273FT556G 20006
HNY14373FT556G 13815
HNY7373FT556G 7950

GEC	LW04
GNA +5%	LW05
GWL	LW06
LP01	
LF02	
LF03	
LN01	
LA02	
LW01	
LW02	

WWP	WOW
PO01	WNO
PO02	WSO
PO03	
PO07	
PO08	
PO09	
WBW	
WSW	
WEC	

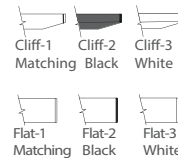

Thermally Fused Laminate Top Upholstered Panels - COM\$

HNY56073FT556M 46927
HNY49173FT556M 41444
HNY42173FT556M 35635
HNY35273FT556M 30152
HNY28273FT556M 24343
HNY21273FT556M 18860
HNY14373FT556M 13051
HNY7373FT556M 7568

MOC
MEC
MSW
MTW
MWL
MNA

WWP	WOW
PO01	WNO
PO02	WSO
PO03	
PO07	
PO08	
PO09	
WBW	
WSW	



Click here to view statement of line

Product Features

- HNY6625WT162 Fixed Desk Height Worksurfaces are included
- 5" Solid wood feet - oval shape
- Ships KD
- T75 worksurface wire cutout is standard on all worksurfaces.(T75D: Delete cutout is optional)

Options

Accessories

- K28: Articulating Keyboard w/ Mouse - \$390
- K31-SK: Center drawer w/ skirt - \$310
- K31: Center drawer w/o skirt - \$205

Delete Top

- DFT: Delete fixed top. Deduct \$1325 Veneer(W), \$1125 High Pressure Laminate (G), \$743 Thermally Fused Laminate (M) per top

Metal Feet

- MTL10: Replace solid wood feet with metal feet, standard MFW White - \$55 ea

Premium Metal Finish

- Specify premium Metal Finish. MFMB: Matte Black, MFS: Silver, MFSS: Salmon Sienna, MFSA: Surfing Aquavert, MFPS: Pistachio, MFOS: Oyster, MFNA: Navy, MFOL: Olive, MFGB: Grey Beige MFGG: Graphite Gray, MFG: Gray, MFGM: Matte Gold
- Premium Metal Finish for WMT Wire Management Tray - \$75 ea
- Premium Metal Finish for MTL10 Metal Feet - \$20 ea
- Premium Metal Finish for PCEB Concealed Floor Power Infeed Cover - \$35

Worksurface Height

- THL-42: Modify worksurface height to bar height - N/C

Wire Tray

- WMT: Wire metal tray. Mounts under top and comes standard in MFW White - \$210

**DARRAN**

**Honey**

Inline 90° Workstation Typical  
Position 5 Desk with Height Adjustable Worksurface

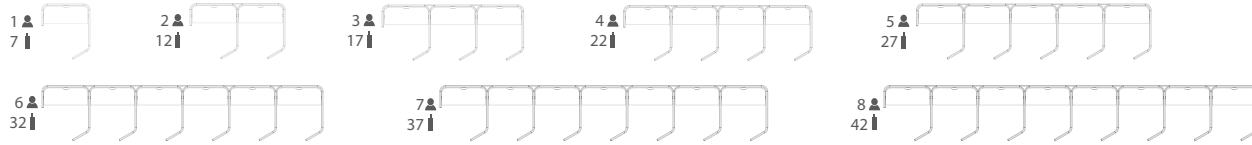

Number of Feet per Typical (MTL10 Option)

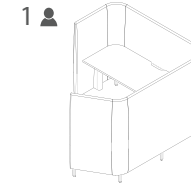

**1 Select Model**

Weight

Standard Veneer Top Upholstered Panels - COM\$

Premium Veneer Top Upholstered Panels - COM\$

High Pressure Laminate Top Upholstered Panels - COM\$

Thermally Fused Laminate Top Upholstered Panels - COM\$

w" x d" x h"	Standard Veneer Top Upholstered Panels - COM\$	Premium Veneer Top Upholstered Panels - COM\$
560 x 83 x 55	8 HNY56083HA557W 77062	"P" Option N/A
491 x 83 x 55	7 HNY49183HA557W 67619	"P" Option N/A
421 x 83 x 55	6 HNY42183HA557W 58176	"P" Option N/A
352 X 83 X 55	5 HNY35283HA557W 48733	"P" Option N/A
282 x 83 x 55	4 HNY28283HA557W 39290	"P" Option N/A
212 x 83 x 55	3 HNY21283HA557W 29847	"P" Option N/A
143 x 83 x 55	2 HNY14383HA557W 20404	"P" Option N/A
73 x 83 x 55	1 HNY7383HA557W 10961	"P" Option N/A

[Click Here for Graded in Pricing](#)

**2 Select Finish**

Click to view finishes

WWP	WOW
PO01	WNO
PO02	WSO
PO03	WNF(Natural Oak on Flat Cut)
PO07	WSF(Salted Oak on Flat Cut)
PO08	WSF(Salted Oak on Flat Cut)
PO09	WSF(Salted Oak on Flat Cut)
WBW	
WSW	
WEC	

**3 Select Feet Finish**

Click to view edges

WWP	WOW
PO01	WNO
PO02	WSO
PO03	
PO07	
PO08	
PO09	
WBW	
WSW	
WEC	

**4 Select Edge**

Click to view details



GEC	LW04
GNA +5%	LW05
GWL	LW06
LP01	
LF02	
LF03	
LN01	
LA02	
LW01	
LW02	

WWP	WOW
PO01	WNO
PO02	WSO
PO03	
PO07	
PO08	
PO09	
WBW	
WSW	
WEC	



MOC
MEC
MSW
MTW
MWL
MNA

WWP	WOW
PO01	WNO
PO02	WSO
PO03	
PO07	
PO08	
PO09	
WEC	
WBW	
WSW	



[Click here to view statement of line](#)

**Product Features**

- HNY6625WT163 Height Adjustable worksurfaces are included
- 5" Solid wood feet - oval shape
- 4 Power outlets with 1 telecom plate, see options below for telecom plate
- Ships KD
- Wire management tray attaches to worksurface top, standard in MFW White, see premium Metal Finish for options
- Hardwire infeed and jumpers are included in workstations
- T75 worksurface wire cutout is standard on all worksurfaces.(T75D: Delete cutout is optional)

**Options**

**Accessories**

- K28: Articulating Keyboard w/ Mouse - \$390
- K31-SK: Center drawer w/ skirt - \$310
- K31: Center drawer w/o skirt - \$205

**Concealed Floor Power Infeed Cover**

- PCEB: White Metal Finish concealed floor power infeed cover - \$150

**Delete Top and Wire Tray**

- DHAT: Delete height adjustable top. Deduct \$3845 Veneer(W), \$3644 High Pressure Laminate(G), \$3262 Thermally Fused Laminate(M) per top

**Metal Feet**

- MTL10: Replace solid wood feet with metal feet, standard MFW White - \$55 ea

**Premium Metal Finish**

- Specify premium Metal Finish. MFMB: Matte Black, MFS: Silver, MFSS: Salmon Sienna, MFSA: SurfIn Aquavert, MFPS: Pistachio, MFOS: Oyster, MFNA: Navy, MFOL: Olive, MFGB: Grey Beige MFGG: Graphite Gray, MFG: Gray, MFGM: Matte Gold
- Premium Metal Finish for WMT Wire Management Tray - \$75 ea
- Premium Metal Finish for MTL10 Metal Feet - \$20 ea
- Premium Metal Finish for PCEB Concealed Floor Power Infeed Cover - \$35

**Telecom Plates**

- Each power unit has 1 plate. All telecom connectors sold separately.
- RJ45 (1) - \$55, RJ45 (2) - \$110, RJ45 (3) - \$165, USB (1) - \$70, USB (2) - \$140, RJ45/USB - \$125, RJ45/HDMI - \$210, HDMI/USB - \$205

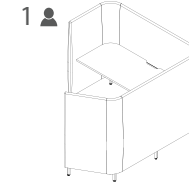
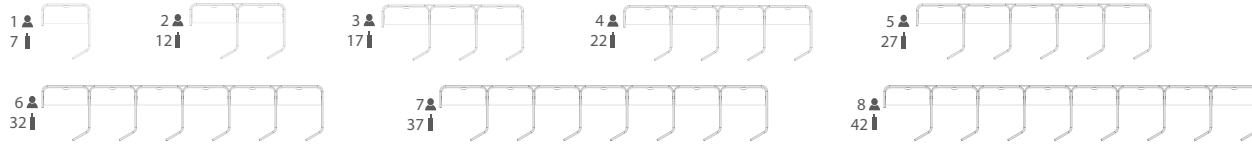

Number of Feet per Typical (MTL10 Option) "SP" Number of Starter Panels per Typical (RSP Option)

1 Select Model

Weight

Standard Veneer Top Upholstered Panels - COM\$

Premium Veneer Top Upholstered Panels - COM\$

High Pressure Laminate Top Upholstered Panels - COM\$

Thermally Fused Laminate Top Upholstered Panels - COM\$

560 x 83 x 55	8	HNY56083FP557W	58582
491 x 83 x 55	7	HNY49183FP557W	51449
421 x 83 x 55	6	HNY42183FP557W	44316
352 x 83 x 55	5	HNY35283FP557W	37183
282 x 83 x 55	4	HNY28283FP557W	30050
212 x 83 x 55	3	HNY21283FP557W	22917
143 x 83 x 55	2	HNY14383FP557W	15784
73 x 83 x 55	1	HNY7383FP557W	8651

"P" Option N/A  
"P" Option N/A  
"P" Option N/A  
"P" Option N/A  
"P" Option N/A  
"P" Option N/A  
"P" Option N/A  
"P" Option N/A

HNY56083FP557G	56982
HNY49183FP557G	50049
HNY42183FP557G	43116
HNY35283FP557G	36183
HNY28283FP557G	29250
HNY21283FP557G	22317
HNY14383FP557G	15384
HNY7383FP557G	8451

HNY56083FP557M	53926
HNY49183FP557M	47375
HNY42183FP557M	40824
HNY35283FP557M	34273
HNY28283FP557M	27722
HNY21283FP557M	21171
HNY14383FP557M	14620
HNY7383FP557M	8069

Click here to view statement of line

Product Features

- HNY6625WT162 Fixed Desk Height Worksurfaces are included
- 5" Solid wood feet - oval shape
- 4 Power outlets with 1 telecom plate, see options below for telecom plate
- Ships KD
- Wire management tray attaches to worksurface top, standard in MFW White, see premium Metal Finish for options
- Hardwire infeed and jumpers are included in workstations
- T75 worksurface wire cutout is standard on all worksurfaces.(T75D: Delete cutout is optional)

Click Here for Graded in Pricing

2 Select Finish

Click to view finishes

WWP	WOW
PO01	WNO
PO02	WSO
PO03	WNF(Natural Oak on Flat Cut)
PO07	WSF(Salted Oak on Flat Cut)
PO08	WSF(Salted Oak on Flat Cut)
PO09	WSF(Salted Oak on Flat Cut)
WBW	
WSW	
WEC	

GEC	LW04
GNA +5%	LW05
GWL	LW06
LP01	
LF02	
LF03	
LN01	
LA02	
LW01	
LW02	

MOC
MEC
MSW
MTW
MWL
MNA

3 Select Feet Finish

Click to view edges

WWP	WOW
PO01	WNO
PO02	WSO
PO03	
PO07	
PO08	
PO09	
WBW	
WSW	
WEC	

WWP	WOW
PO01	WNO
PO02	WSO
PO03	
PO07	
PO08	
PO09	
WBW	
WSW	
WEC	

WWP	WOW
PO01	WNO
PO02	WSO
PO03	
PO07	
PO08	
PO09	
WEC	
WBW	
WSW	

4 Select Edge

Click to view details

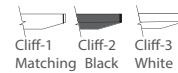
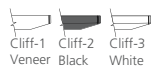

Options

Accessories

- K28: Articulating Keyboard w/ Mouse - \$390
- K31-SK: Center drawer w/ skirt - \$310
- K31: Center drawer w/o skirt - \$205

Concealed Floor Power Infeed Cover

- PCEB: White Metal Finish concealed floor power infeed cover - \$150

Delete Top and Wire Tray

- DFP: Delete fixed top. Deduct \$1535 Veneer (W), \$1335 High Pressure Laminate (G), \$953 Thermally Fused Laminate (M) per top

Metal Feet

- MTL10: Replace solid wood feet with metal feet, standard MFW White - \$55 ea

Premium Metal Finish

- Specify premium Metal Finish. MFMB: Matte Black, MFS: Silver, MFSS: Salmon Sienna, MFSA: Surfing Aquavert, MFPS: Pistachio, MFOS: Oyster, MFNA: Navy, MFOL: Olive, MFGB: Grey Beige MFGG: Graphite Gray, MFG: Gray, MFGM: Matte Gold
- Premium Metal Finish for WMT Wire Management Tray - \$75 ea
- Premium Metal Finish for MTL10 Metal Feet - \$20 ea
- Premium Metal Finish for PCEB Concealed Floor Power Infeed Cover - \$35

Telecom Plates

- Each power unit has 1 plate. All telecom connectors sold separately.
- RJ45 (1) - \$55, RJ45 (2) - \$110, RJ45 (3) - \$165, USB (1) - \$70, USB (2) - \$140, RJ45/USB - \$125, RJ45/HDMI - \$210, HDMI/USB - \$205

Worksurface Height

- THL-42: Modify worksurface height to bar height - N/C



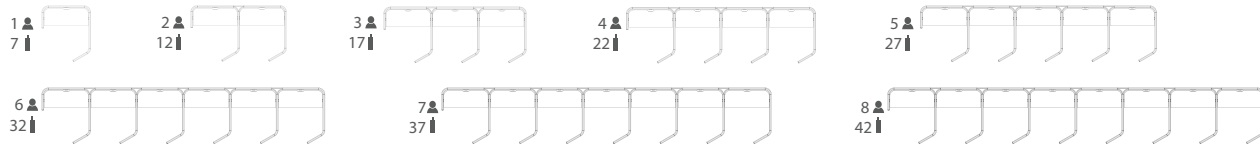

Number of Feet per Typical (MTL10 Option)

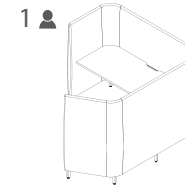

Fixed Top Workstation

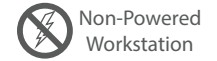

Non-Powered Workstation

1 Select Model

Weight

Standard Veneer Top Upholstered Panels - COM\$

Premium Veneer Top Upholstered Panels - COM\$

High Pressure Laminate Top Upholstered Panels - COM\$

Thermally Fused Laminate Top Upholstered Panels - COM\$

560 x 83 x 55	8	HNY56083FT557W	52584
491 x 83 x 55	7	HNY49183FT557W	46177
421 x 83 x 55	6	HNY42183FT557W	39770
352 x 83 x 55	5	HNY35283FT557W	33363
282 x 83 x 55	4	HNY28283FT557W	26956
212 x 83 x 55	3	HNY21283FT557W	20549
143 x 83 x 55	2	HNY14383FT557W	14142
73 x 83 x 55	1	HNY7383FT557W	7735

"P" Option N/A  
"P" Option N/A  
"P" Option N/A  
"P" Option N/A  
"P" Option N/A  
"P" Option N/A  
"P" Option N/A  
"P" Option N/A

HNY56083FT557G	50984
HNY49183FT557G	44777
HNY42183FT557G	38570
HNY35283FT557G	32363
HNY28283FT557G	26156
HNY21283FT557G	19949
HNY14383FT557G	13742
HNY7383FT557G	7535

HNY56083FT557M	47928
HNY49183FT557M	42103
HNY42183FT557M	36278
HNY35283FT557M	30453
HNY28283FT557M	24628
HNY21283FT557M	18803
HNY14383FT557M	12978
HNY7383FT557M	7153

Click here to view statement of line

Product Features

- HNY6625WT162 Fixed Desk Height Worksurfaces are included
- 5" Solid wood feet - oval shape
- Ships KD
- T75 worksurface wire cutout is standard on all worksurfaces.(T75D: Delete cutout is optional)

Options

Accessories

- K28: Articulating Keyboard w/ Mouse - \$390
- K31-SK: Center drawer w/ skirt - \$310
- K31: Center drawer w/o skirt - \$205

Delete Top

- DFT: Delete fixed top. Deduct \$1325 Veneer(W), \$1125 High Pressure Laminate (G), \$743 Thermally Fused Laminate (M) per top

Metal Feet

- MTL10: Replace solid wood feet with metal feet, standard MFW White - \$55 ea

Premium Metal Finish

- Specify premium Metal Finish. MFMB: Matte Black, MFS: Silver, MFSS: Salmon Sienna, MFSA: Surfing Aquavert, MFPS: Pistachio, MFOS: Oyster, MFNA: Navy, MFOL: Olive, MFGB: Grey Beige MFGG: Graphite Gray, MFG: Gray, MFGM: Matte Gold
- Premium Metal Finish for WMT Wire Management Tray - \$75 ea
- Premium Metal Finish for MTL10 Metal Feet - \$20 ea
- Premium Metal Finish for PCEB Concealed Floor Power Infeed Cover - \$35

Worksurface Height

- THL-42: Modify worksurface height to bar height - N/C

Wire Tray

- WMT: Wire metal tray. Mounts under top and comes standard in MFW White - \$210

Click Here for Graded in Pricing

2 Select Finish

Click to view finishes

WWP	WOW
PO01	WNO
PO02	WSO
PO03	WNF(Natural Oak on Flat Cut)
PO07	WSF(Salted Oak on Flat Cut)
PO08	WSF(Salted Oak on Flat Cut)
PO09	WSF(Salted Oak on Flat Cut)
WBW	
WSW	
WEC	

3 Select Feet Finish

Click to view edges

WWP	WOW
PO01	WNO
PO02	WSO
PO03	
PO07	
PO08	
PO09	
WBW	
WSW	
WEC	

4 Select Edge

Click to view details



**DARRAN**

**Honey**

Inline 90° Workstation Typical  
Position 6 Desk with Height Adjustable Worksurface

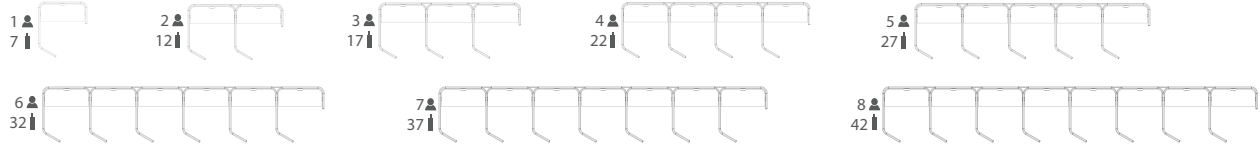

Number of Feet per Typical (MTL10 Option)

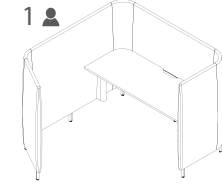

Height Adjustable Workstation

Powered Workstation

**1 Select Model**

Weight

Standard Veneer Top Upholstered Panels - COM\$

Premium Veneer Top Upholstered Panels - COM\$

High Pressure Laminate Top Upholstered Panels - COM\$

Thermally Fused Laminate Top Upholstered Panels - COM\$

560 x 83 x 55	8	HNY56083HA558W	77062
491 x 83 x 55	7	HNY49183HA558W	67619
421 x 83 x 55	6	HNY42183HA558W	58176
352 X 83 X 55	5	HNY35283HA558W	48733
282 x 83 x 55	4	HNY28283HA558W	39290
212 x 83 x 55	3	HNY21283HA558W	29847
143 x 83 x 55	2	HNY14383HA558W	20404
73 x 83 x 55	1	HNY7383HA558W	10961

"P" Option N/A  
"P" Option N/A  
"P" Option N/A  
"P" Option N/A  
"P" Option N/A  
"P" Option N/A  
"P" Option N/A  
"P" Option N/A

HNY56083HA558G	75454
HNY49183HA558G	66212
HNY42183HA558G	56970
HNY35283HA558G	47728
HNY28283HA558G	38486
HNY21283HA558G	29244
HNY14383HA558G	20002
HNY7383HA558G	10760

HNY56083HA558M	72398
HNY49183HA558M	63538
HNY42183HA558M	54678
HNY35283HA558M	45818
HNY28283HA558M	36958
HNY21283HA558M	28098
HNY14383HA558M	19238
HNY7383HA558M	10378

[Click here to view statement of line](#)

**Product Features**

- HNY6625WT163 Height Adjustable worksurfaces are included
- 5" Solid wood feet - oval shape
- 4 Power outlets with 1 telecom plate, see options below for telecom plate
- Ships KD
- Wire management tray attaches to worksurface top, standard in MFW White, see premium Metal Finish for options
- Hardwire infeed and jumpers are included in workstations
- T75 worksurface wire cutout is standard on all worksurfaces.(T75D: Delete cutout is optional)

[Click Here for Graded in Pricing](#)

**2 Select Finish**

Click to view finishes

WWP	WOW
PO01	WNO
PO02	WSO
PO03	WNF(Natural Oak on Flat Cut)
PO07	WSF(Salted Oak on Flat Cut)
PO08	WSF(Salted Oak on Flat Cut)
PO09	WSF(Salted Oak on Flat Cut)
WBW	
WSW	
WEC	

GEC	LW04
GNA +5%	LW05
GWL	LW06
LP01	
LF02	
LF03	
LN01	
LA02	
LW01	
LW02	

MOC
MEC
MSW
MTW
MWL
MNA

**3 Select Feet Finish**

Click to view edges

WWP	WOW
PO01	WNO
PO02	WSO
PO03	
PO07	
PO08	
PO09	
WBW	
WSW	
WEC	

WWP	WOW
PO01	WNO
PO02	WSO
PO03	
PO07	
PO08	
PO09	
WBW	
WSW	
WEC	

WWP	WOW
PO01	WNO
PO02	WSO
PO03	
PO07	
PO08	
PO09	
WEC	
WBW	
WSW	

**4 Select Edge**

Click to view details

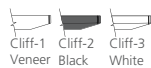

**Options**

**Accessories**

- K28: Articulating Keyboard w/ Mouse - \$390
- K31-SK: Center drawer w/ skirt - \$310
- K31: Center drawer w/o skirt - \$205

**Concealed Floor Power Infeed Cover**

- PCEB: White Metal Finish concealed floor power infeed cover - \$150

**Delete Top and Wire Tray**

- DHAT: Delete height adjustable top. Deduct \$3845 Veneer(W), \$3644 High Pressure Laminate(G), \$3262 Thermally Fused Laminate(M) per top

**Metal Feet**

- MTL10: Replace solid wood feet with metal feet, standard MFW White - \$55 ea

**Premium Metal Finish**

- Specify premium Metal Finish. MFMB: Matte Black, MFS: Silver, MFSS: Salmon Sienna, MFSA: SurfIn Aquavert, MFPS: Pistachio, MFOS: Oyster, MFNA: Navy, MFOL: Olive, MFGB: Grey Beige MFGG: Graphite Gray, MFG: Gray, MFGM: Matte Gold
- Premium Metal Finish for WMT Wire Management Tray - \$75 ea
- Premium Metal Finish for MTL10 Metal Feet - \$20 ea
- Premium Metal Finish for PCEB Concealed Floor Power Infeed Cover - \$35

**Telecom Plates**

- Each power unit has 1 plate. All telecom connectors sold separately.
- RJ45 (1) - \$55, RJ45 (2) - \$110, RJ45 (3) - \$165, USB (1) - \$70, USB (2) - \$140, RJ45/USB - \$125, RJ45/HDMI - \$210, HDMI/USB - \$205

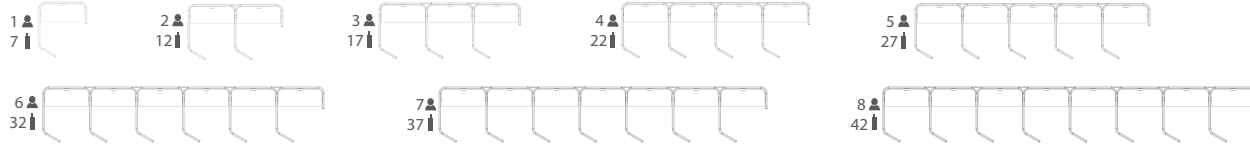

Number of Feet per Typical (MTL10 Option)

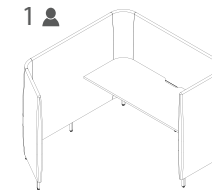

Fixed Top Workstation

Powered Workstation

1 Select Model

Weight

Standard Veneer Top Upholstered Panels - COM\$

Premium Veneer Top Upholstered Panels - COM\$

High Pressure Laminate Top Upholstered Panels - COM\$

Thermally Fused Laminate Top Upholstered Panels - COM\$

560 x 83 x 55	8	HNY56083FP558W	58582
491 x 83 x 55	7	HNY49183FP558W	51449
421 x 83 x 55	6	HNY42183FP558W	44316
352 x 83 x 55	5	HNY35283FP558W	37183
282 x 83 x 55	4	HNY28283FP558W	30050
212 x 83 x 55	3	HNY21283FP558W	22917
143 x 83 x 55	2	HNY14383FP558W	15784
73 x 83 x 55	1	HNY7383FP558W	8651

"P" Option N/A  
"P" Option N/A  
"P" Option N/A  
"P" Option N/A  
"P" Option N/A  
"P" Option N/A  
"P" Option N/A  
"P" Option N/A

HNY56083FP558G	56982
HNY49183FP558G	50049
HNY42183FP558G	43116
HNY35283FP558G	36183
HNY28283FP558G	29250
HNY21283FP558G	22317
HNY14383FP558G	15384
HNY7383FP558G	8451

HNY56083FP558M	53926
HNY49183FP558M	47375
HNY42183FP558M	40824
HNY35283FP558M	34273
HNY28283FP558M	27722
HNY21283FP558M	21171
HNY14383FP558M	14620
HNY7383FP558M	8069

[Click here to view statement of line](#)

Product Features

- HNY6625WT162 Fixed Desk Height Worksurfaces are included
- 5" Solid wood feet - oval shape
- 4 Power outlets with 1 telecom plate, see options below for telecom plate
- Ships KD
- Wire management tray attaches to worksurface top, standard in MFW White, see premium Metal Finish for options
- Hardwire infeed and jumpers are included in workstations
- T75 worksurface wire cutout is standard on all worksurfaces.(T75D: Delete cutout is optional)

[Click Here for Graded in Pricing](#)

2 Select Finish

Click to view finishes

WWP	WOW
PO01	WNO
PO02	WSO
PO03	WNF(Natural Oak on Flat Cut)
PO07	WSF(Salted Oak on Flat Cut)
PO08	WSF(Salted Oak on Flat Cut)
PO09	WSF(Salted Oak on Flat Cut)
WBW	
WSW	
WEC	

GEC	LW04
GNA +5%	LW05
GWL	LW06
LP01	
LF02	
LF03	
LN01	
LA02	
LW01	
LW02	

MOC
MEC
MSW
MTW
MWL
MNA

3 Select Feet Finish

Click to view edges

WWP	WOW
PO01	WNO
PO02	WSO
PO03	
PO07	
PO08	
PO09	
WBW	
WSW	
WEC	

WWP	WOW
PO01	WNO
PO02	WSO
PO03	
PO07	
PO08	
PO09	
WBW	
WSW	
WEC	

WWP	WOW
PO01	WNO
PO02	WSO
PO03	
PO07	
PO08	
PO09	
WEC	
WBW	
WSW	

4 Select Edge

Click to view details



Options

Accessories

- K28: Articulating Keyboard w/ Mouse - \$390
- K31-SK: Center drawer w/ skirt - \$310
- K31: Center drawer w/o skirt - \$205

Concealed Floor Power Infeed Cover

- PCEB: White Metal Finish concealed floor power infeed cover - \$150

Delete Top and Wire Tray

- DFP: Delete fixed top. Deduct \$1535 Veneer (W), \$1335 High Pressure Laminate (G), \$953 Thermally Fused Laminate (M) per top

Metal Feet

- MTL10: Replace solid wood feet with metal feet, standard MFW White - \$55 ea

Premium Metal Finish

- Specify premium Metal Finish. MFMB: Matte Black, MFS: Silver, MFSS: Salmon Sienna, MFSA: Surfing Aquavert, MFPS: Pistachio, MFOS: Oyster, MFNA: Navy, MFOL: Olive, MFGB: Grey Beige MFGG: Graphite Gray, MFG: Gray, MFGM: Matte Gold
- Premium Metal Finish for WMT Wire Management Tray - \$75 ea
- Premium Metal Finish for MTL10 Metal Feet - \$20 ea
- Premium Metal Finish for PCEB Concealed Floor Power Infeed Cover - \$35

Telecom Plates

- Each power unit has 1 plate. All telecom connectors sold separately.
- RJ45 (1) - \$55, RJ45 (2) - \$110, RJ45 (3) - \$165, USB (1) - \$70, USB (2) - \$140, RJ45/USB - \$125, RJ45/HDMI - \$210, HDMI/USB - \$205

Worksurface Height

- THL-42: Modify worksurface height to bar height - N/C

**DARRAN**

**Honey**

Inline 90° Workstation Typical  
Position 6 Desk with Fixed Worksurface

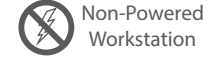
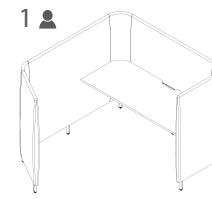
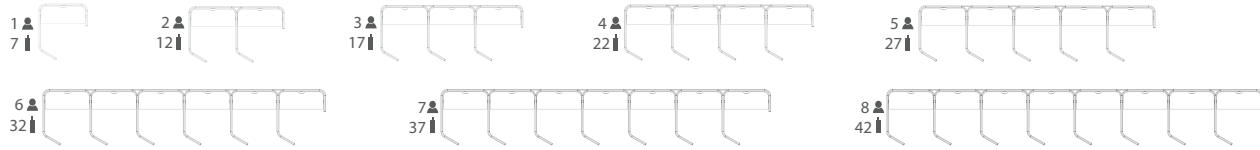

Number of Feet per Typical (MTL10 Option)

**1 Select Model**

Weight

Standard Veneer Top Upholstered Panels - COM\$

Premium Veneer Top Upholstered Panels - COM\$

High Pressure Laminate Top Upholstered Panels - COM\$

Thermally Fused Laminate Top Upholstered Panels - COM\$

w" x d" x h"	Standard Veneer Top Upholstered Panels - COM\$	Premium Veneer Top Upholstered Panels - COM\$
560 x 83 x 55	8 HNY56083FT558W 52584	"P" Option N/A
491 x 83 x 55	7 HNY49183FT558W 46177	"P" Option N/A
421 x 83 x 55	6 HNY42183FT558W 39770	"P" Option N/A
352 x 83 x 55	5 HNY35283FT558W 33363	"P" Option N/A
282 x 83 x 55	4 HNY28283FT558W 26956	"P" Option N/A
212 x 83 x 55	3 HNY21283FT558W 20549	"P" Option N/A
143 x 83 x 55	2 HNY14383FT558W 14142	"P" Option N/A
73 x 83 x 55	1 HNY7383FT558W 7735	"P" Option N/A

"P" Option N/A  
"P" Option N/A  
"P" Option N/A  
"P" Option N/A  
"P" Option N/A  
"P" Option N/A  
"P" Option N/A  
"P" Option N/A

HNY56083FT558G	50984
HNY49183FT558G	44777
HNY42183FT558G	38570
HNY35283FT558G	32363
HNY28283FT558G	26156
HNY21283FT558G	19949
HNY14383FT558G	13742
HNY7383FT558G	7535

HNY56083FT558M	47928
HNY49183FT558M	42103
HNY42183FT558M	36278
HNY35283FT558M	30453
HNY28283FT558M	24628
HNY21283FT558M	18803
HNY14383FT558M	12978
HNY7383FT558M	7153

[Click here to view statement of line](#)

**Product Features**

- HNY6625WT162 Fixed Desk Height Worksurfaces are included
- 5" Solid wood feet - oval shape
- Ships KD
- T75 worksurface wire cutout is standard on all worksurfaces.(T75D: Delete cutout is optional)

**Options**

**Accessories**

- K28: Articulating Keyboard w/ Mouse - \$390
- K31-SK: Center drawer w/ skirt - \$310
- K31: Center drawer w/o skirt - \$205

**Delete Top**

- DFT: Delete fixed top. Deduct \$1325 Veneer(W), \$1125 High Pressure Laminate (G), \$743 Thermally Fused Laminate (M) per top

**Metal Feet**

- MTL10: Replace solid wood feet with metal feet, standard MFW White - \$55 ea

**Premium Metal Finish**

- Specify premium Metal Finish. MFMB: Matte Black, MFS: Silver, MFSS: Salmon Sienna, MFSA: Surfing Aquavert, MFPS: Pistachio, MFOS: Oyster, MFNA: Navy, MFOL: Olive, MFGB: Grey Beige MFGG: Graphite Gray, MFG: Gray, MFGM: Matte Gold
- Premium Metal Finish for WMT Wire Management Tray - \$75 ea
- Premium Metal Finish for MTL10 Metal Feet - \$20 ea
- Premium Metal Finish for PCEB Concealed Floor Power Infeed Cover - \$35

**Worksurface Height**

- THL-42: Modify worksurface height to bar height - N/C

**Wire Tray**

- WMT: Wire metal tray. Mounts under top and comes standard in MFW White - \$210

[Click Here for Graded in Pricing](#)

**2 Select Finish**

Click to view finishes

WWP	WOW
PO01	WNO
PO02	WSO
PO03	WNF(Natural Oak on Flat Cut)
PO07	WSF(Salted Oak on Flat Cut)
PO08	WSF(Salted Oak on Flat Cut)
PO09	WSF(Salted Oak on Flat Cut)
WBW	
WSW	
WEC	

**3 Select Feet Finish**

Click to view edges

WWP	WOW
PO01	WNO
PO02	WSO
PO03	
PO07	
PO08	
PO09	
WBW	
WSW	
WEC	

**4 Select Edge**

Click to view details

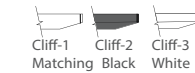
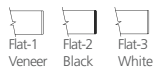

**DARRAN**

**Honey**

Linear 90° Workstation Typical  
Height Adjustable Worksurface

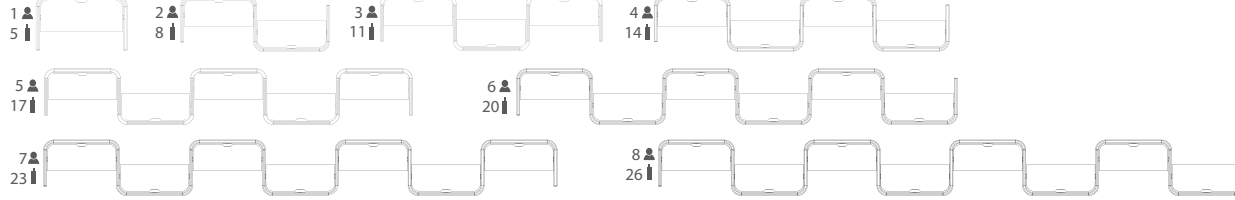

Number of Feet per Typical (MTL10 Option)

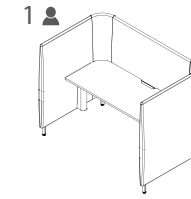

**1 Select Model**

Weight

Standard Veneer Top Upholstered Panels - COM\$

Premium Veneer Top Upholstered Panels - COM\$

High Pressure Laminate Top Upholstered Panels - COM\$

Thermally Fused Laminate Top Upholstered Panels - COM\$

w" x d" x h"		
560 x 53 x 55	8 HNY56053HA559W	64635
491 x 53 x 55	7 HNY49153HA559W	56676
421 x 53 x 55	6 HNY42153HA559W	48717
352 x 53 x 55	5 HNY35253HA559W	40758
282 x 53 x 55	4 HNY28253HA559W	32799
212 x 53 x 55	3 HNY21253HA559W	24840
143 x 53 x 55	2 HNY14353HA559W	16881
73 x 45 x 55	1 HNY7345HA559W	8922

"P" Option N/A  
"P" Option N/A  
"P" Option N/A  
"P" Option N/A  
"P" Option N/A  
"P" Option N/A  
"P" Option N/A  
"P" Option N/A  
"P" Option N/A

HNY56053HA559G	63027
HNY49153HA559G	55269
HNY42153HA559G	47511
HNY35253HA559G	39753
HNY28253HA559G	31995
HNY21253HA559G	24237
HNY14353HA559G	16479
HNY7345HA559G	8721

HNY56053HA559M	59971
HNY49153HA559M	52595
HNY42153HA559M	45219
HNY35253HA559M	37843
HNY28253HA559M	30467
HNY21253HA559M	23091
HNY14353HA559M	15715
HNY7345HA559M	8339

[Click here to view statement of line](#)

**Product Features**

- HNY6625WT163 Height Adjustable worksurfaces are included
- 5" Solid wood feet - oval shape
- 4 Power outlets with 1 telecom plate, see options below for telecom plate
- Ships KD
- Wire management tray attaches to worksurface top, standard in MFW White, see premium Metal Finish for options
- Hardwire infeed and jumpers are included in workstations
- T75 worksurface wire cutout is standard on all worksurfaces.(T75D: Delete cutout is optional)

[Click Here for Graded in Pricing](#)

**2 Select Finish**

Click to view finishes

WWP	WOW
PO01	WNO
PO02	WSO
PO03	WNF(Natural Oak on Flat Cut)
PO07	WSF(Salted Oak on Flat Cut)
PO08	WSF(Salted Oak on Flat Cut)
PO09	
WBW	
WSW	
WEC	

GEC	LW04
GNA +5%	LW05
GWL	LW06
LP01	
LF02	
LF03	
LN01	
LA02	
LW01	
LW02	

MOC
MEC
MSW
MTW
MWL
MNA

**3 Select Feet Finish**

Click to view edges

WWP	WOW
PO01	WNO
PO02	WSO
PO03	
PO07	
PO08	
PO09	
WBW	
WSW	
WEC	

WWP	WOW
PO01	WNO
PO02	WSO
PO03	
PO07	
PO08	
PO09	
WBW	
WSW	
WEC	

WWP	WOW
PO01	WNO
PO02	WSO
PO03	
PO07	
PO08	
PO09	
WEC	
WBW	
WSW	

**4 Select Edge**

Click to view details



**Options**

**Accessories**

- K28: Articulating Keyboard w/ Mouse - \$390
- K31-SK: Center drawer w/ skirt - \$310
- K31: Center drawer w/o skirt - \$205

**Concealed Floor Power Infeed Cover**

- PCEB: White Metal Finish concealed floor power infeed cover - \$150

**Delete Top and Wire Tray**

- DHAT: Delete height adjustable top. Deduct \$3845 Veneer(W), \$3644 High Pressure Laminate(G), \$3262 Thermally Fused Laminate(M) per top

**Metal Feet**

- MTL10: Replace solid wood feet with metal feet, standard MFW White - \$55 ea

**Premium Metal Finish**

- Specify premium Metal Finish. MFMB: Matte Black, MFS: Silver, MFSS: Salmon Sienna, MFSA: SurfIn Aquavert, MFPS: Pistachio, MFOS: Oyster, MFNA: Navy, MFOL: Olive, MFGB: Grey Beige MFGG: Graphite Gray, MFG: Gray, MFGM: Matte Gold
- Premium Metal Finish for WMT Wire Management Tray - \$75 ea
- Premium Metal Finish for MTL10 Metal Feet - \$20 ea
- Premium Metal Finish for PCEB Concealed Floor Power Infeed Cover - \$35

**Telecom Plates**

- Each power unit has 1 plate. All telecom connectors sold separately.
- RJ45 (1) - \$55, RJ45 (2) - \$110, RJ45 (3) - \$165, USB (1) - \$70, USB (2) - \$140, RJ45/USB - \$125, RJ45/HDMI - \$210, HDMI/USB - \$205

**DARRAN**

**Honey**

Linear 90° Workstation Typical

Fixed Power Worksurface

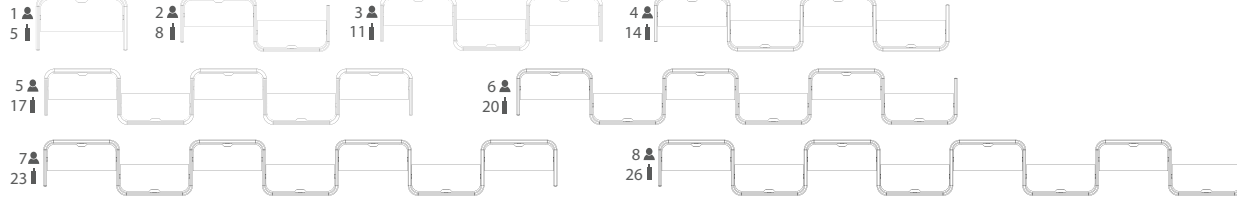

Number of Feet per Typical (MTL10 Option)

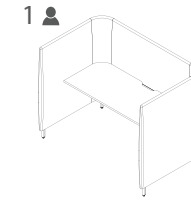

Fixed Top Workstation

Powered Workstation

**1 Select Model**

Weight

Standard Veneer Top Upholstered Panels - COM\$

Premium Veneer Top Upholstered Panels - COM\$

High Pressure Laminate Top Upholstered Panels - COM\$

Thermally Fused Laminate Top Upholstered Panels - COM\$

w" x d" x h"	Standard Veneer Top Upholstered Panels - COM\$	Premium Veneer Top Upholstered Panels - COM\$
560 x 53 x 55	8 HNY56053FP559W 46155	"P" Option N/A
491 x 53 x 55	7 HNY49153FP559W 40506	"P" Option N/A
421 x 53 x 55	6 HNY42153FP559W 34857	"P" Option N/A
352 x 53 x 55	5 HNY35253FP559W 29208	"P" Option N/A
282 x 53 x 55	4 HNY28253FP559W 23559	"P" Option N/A
212 x 53 x 55	3 HNY21253FP559W 17910	"P" Option N/A
143 x 53 x 55	2 HNY14353FP559W 12261	"P" Option N/A
73 x 45 x 55	1 HNY7345FP559W 6612	"P" Option N/A

"P" Option N/A	HNY56053FP559G 44555
"P" Option N/A	HNY49153FP559G 39106
"P" Option N/A	HNY42153FP559G 33657
"P" Option N/A	HNY35253FP559G 28208
"P" Option N/A	HNY28253FP559G 22759
"P" Option N/A	HNY21253FP559G 17310
"P" Option N/A	HNY14353FP559G 11861
"P" Option N/A	HNY7345FP559G 6412

HNY56053FP559M 41499	HNY49153FP559M 36432
HNY42153FP559M 31365	HNY35253FP559M 26298
HNY28253FP559M 21231	HNY21253FP559M 16164
HNY14353FP559M 11097	HNY7345FP559M 6030

[Click here to view statement of line](#)

**Product Features**

- HNY6625WT162 Fixed Desk Height Worksurfaces are included
- 5" Solid wood feet - oval shape
- 4 Power outlets with 1 telecom plate, see options below for telecom plate
- Ships KD
- Wire management tray attaches to worksurface top, standard in MFW White, see premium Metal Finish for options
- Hardwire infeed and jumpers are included in workstations
- T75 worksurface wire cutout is standard on all worksurfaces.(T75D: Delete cutout is optional)

[Click Here for Graded in Pricing](#)

**2 Select Finish**

Click to view finishes

WWP	WOW
PO01	WNO
PO02	WSO
PO03	WNF(Natural Oak on Flat Cut)
PO07	WSF(Salted Oak on Flat Cut)
PO08	WSF(Salted Oak on Flat Cut)
PO09	WSF(Salted Oak on Flat Cut)
WBW	
WSW	
WEC	

GEC	LW04
GNA +5%	LW05
GWL	LW06
LP01	
LF02	
LF03	
LN01	
LA02	
LW01	
LW02	

MOC
MEC
MSW
MTW
MWL
MNA

**3 Select Feet Finish**

Click to view edges

WWP	WOW
PO01	WNO
PO02	WSO
PO03	
PO07	
PO08	
PO09	
WBW	
WSW	
WEC	

WWP	WOW
PO01	WNO
PO02	WSO
PO03	
PO07	
PO08	
PO09	
WBW	
WSW	
WEC	

WWP	WOW
PO01	WNO
PO02	WSO
PO03	
PO07	
PO08	
PO09	
WEC	
WBW	
WSW	

**4 Select Edge**

Click to view details



**Options**

**Accessories**

- K28: Articulating Keyboard w/ Mouse - \$390
- K31-SK: Center drawer w/ skirt - \$310
- K31: Center drawer w/o skirt - \$205

**Concealed Floor Power Infeed Cover**

- PCEB: White Metal Finish concealed floor power infeed cover - \$150

**Delete Top and Wire Tray**

- DFP: Delete fixed top. Deduct \$1535 Veneer (W), \$1335 High Pressure Laminate (G), \$953 Thermally Fused Laminate (M) per top

**Metal Feet**

- MTL10: Replace solid wood feet with metal feet, standard MFW White - \$55 ea

**Premium Metal Finish**

- Specify premium Metal Finish. MFMB: Matte Black, MFS: Silver, MFSS: Salmon Sienna, MFSA: Surfing Aquavert, MFPS: Pistachio, MFOS: Oyster, MFNA: Navy, MFOL: Olive, MFGB: Grey Beige MFGG: Graphite Gray, MFG: Gray, MFGM: Matte Gold
- Premium Metal Finish for WMT Wire Management Tray - \$75 ea
- Premium Metal Finish for MTL10 Metal Feet - \$20 ea
- Premium Metal Finish for PCEB Concealed Floor Power Infeed Cover - \$35

**Telecom Plates**

- Each power unit has 1 plate. All telecom connectors sold separately.
- RJ45 (1) - \$55, RJ45 (2) - \$110, RJ45 (3) - \$165, USB (1) - \$70, USB (2) - \$140, RJ45/USB - \$125, RJ45/HDMI - \$210, HDMI/USB - \$205
- THL-42: Modify worksurface height to bar height - N/C

**DARRAN**

**Honey**

Linear 90° Workstation Typical

Fixed Worksurface

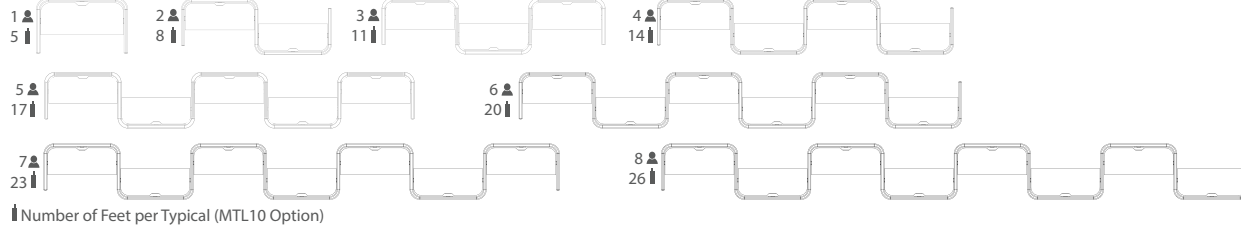

Number of Feet per Typical (MTL10 Option)

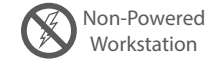
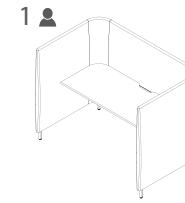

**1 Select Model**

Weight

Standard Veneer Top Upholstered Panels - COM\$

Premium Veneer Top Upholstered Panels - COM\$

High Pressure Laminate Top Upholstered Panels - COM\$

Thermally Fused Laminate Top Upholstered Panels - COM\$

w" x d" x h"	8	39568
560 x 53 x 55	HNY56053FT559W	39568
491 x 53 x 55	HNY49153FT559W	34736
421 x 53 x 55	HNY42153FT559W	29904
352 x 53 x 55	HNY35253FT559W	25072
282 x 53 x 55	HNY28253FT559W	20240
212 x 53 x 55	HNY21253FT559W	15408
143 x 53 x 55	HNY14353FT559W	10576
73 x 45 x 55	HNY7345FT559W	5744

"P" Option N/A  
"P" Option N/A  
"P" Option N/A  
"P" Option N/A  
"P" Option N/A  
"P" Option N/A  
"P" Option N/A  
"P" Option N/A  
"P" Option N/A

HNY56053FT559G	37968
HNY49153FT559G	33336
HNY42153FT559G	28704
HNY35253FT559G	24072
HNY28253FT559G	19440
HNY21253FT559G	14808
HNY14353FT559G	10176
HNY7345FT559G	5544

HNY56053FT559M	34912
HNY49153FT559M	30662
HNY42153FT559M	26412
HNY35253FT559M	22162
HNY28253FT559M	17912
HNY21253FT559M	13662
HNY14353FT559M	9381
HNY7345FT559M	5162

[Click here to view statement of line](#)

**Product Features**

- HNY6625WT162 Fixed Desk Height Worksurfaces are included
- 5" Solid wood feet - oval shape
- Ships KD
- T75 worksurface wire cutout is standard on all worksurfaces.(T75D: Delete cutout is optional)

**Options**

**Accessories**

- K28: Articulating Keyboard w/ Mouse - \$390
- K31-SK: Center drawer w/ skirt - \$310
- K31: Center drawer w/o skirt - \$205

**Delete Top**

- DFT: Delete fixed top. Deduct \$1325 Veneer(W), \$1125 High Pressure Laminate (G), \$743 Thermally Fused Laminate (M) per top

**Metal Feet**

- MTL10: Replace solid wood feet with metal feet, standard MFW White - \$55 ea

**Premium Metal Finish**

- Specify premium Metal Finish. MFMB: Matte Black, MFS: Silver, MFSS: Salmon Sienna, MFSA: Surfing Aquavert, MFPS: Pistachio, MFOS: Oyster, MFNA: Navy, MFOL: Olive, MFGB: Grey Beige MFGG: Graphite Gray, MFG: Gray, MFGM: Matte Gold
- Premium Metal Finish for WMT Wire Management Tray - \$75 ea
- Premium Metal Finish for MTL10 Metal Feet - \$20 ea
- Premium Metal Finish for PCEB Concealed Floor Power Infeed Cover - \$35

**Worksurface Height**

- THL-42: Modify worksurface height to bar height - N/C

**Wire Tray**

- WMT: Wire metal tray. Mounts under top and comes standard in MFW White - \$210

[Click Here for Graded in Pricing](#)

**2 Select Finish**

Click to view finishes

WWP	WOW
PO01	WNO
PO02	WSO
PO03	WNF(Natural Oak on Flat Cut)
PO07	WSF(Salted Oak on Flat Cut)
PO08	WSF(Salted Oak on Flat Cut)
PO09	WSF(Salted Oak on Flat Cut)
WBW	
WSW	
WEC	

**3 Select Feet Finish**

Click to view edges

WWP	WOW
PO01	WNO
PO02	WSO
PO03	
PO07	
PO08	
PO09	
WBW	
WSW	
WEC	

**4 Select Edge**

Click to view details

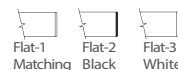



Height Adjustable Workstation



Powered Workstation

Number of Feet per Typical (MTL10 Option)

1 Select Model

Weight

w" x d" x h"	Standard Veneer Top Upholstered Panels - COM\$	Premium Veneer Top Upholstered Panels - COM\$	High Pressure Laminate Top Upholstered Panels - COM\$	Thermally Fused Laminate Top Upholstered Panels - COM\$
282 x 64 x 55	8 HNY28264HA560W 51938	"P" Option N/A	HNY28264HA560G 50330	HNY28264HA560M 47274
212 x 64 x 55	6 HNY21264HA560W 39618	"P" Option N/A	HNY21264HA560G 38412	HNY21264HA560M 36120
143 x 64 x 55	4 HNY14364HA560W 27298	"P" Option N/A	HNY14364HA560G 26494	HNY14364HA560M 24966
73 x 64 x 55	2 HNY7364HA560W 14978	"P" Option N/A	HNY7364HA560G 14576	HNY7364HA560M 13812

[Click Here for Graded in Pricing](#)

2 Select Finish

Click to view finishes

WWP	WOW
PO01	WNO
PO02	WSO
PO03	WNF(Natural Oak on Flat Cut)
PO07	WSF(Salted Oak on Flat Cut)
PO08	WSF(Salted Oak on Flat Cut)
PO09	WSF(Salted Oak on Flat Cut)
WBW	
WSW	
WEC	

3 Select Feet Finish

Click to view edges

WWP	WOW
PO01	WNO
PO02	WSO
PO03	
PO07	
PO08	
PO09	
WBW	
WSW	
WEC	

4 Select Edge

Click to view details

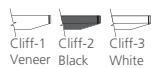

GEC	LW04
GNA +5%	LW05
GWL	LW06
LP01	
LF02	
LF03	
LN01	
LA02	
LW01	
LW02	

WWP	WOW
PO01	WNO
PO02	WSO
PO03	
PO07	
PO08	
PO09	
WBW	
WSW	
WEC	



MOC
MEC
MSW
MTW
MWL
MNA

WWP	WOW
PO01	WNO
PO02	WSO
PO03	
PO07	
PO08	
PO09	
WEC	
WBW	
WSW	



[Click here to view statement of line](#)

Product Features

- HNY6625WT163 Height Adjustable worksurfaces are included
- 5" Solid wood feet - oval shape
- 4 Power outlets with 1 telecom plate, see options below for telecom plate
- Ships KD
- Wire management tray attaches to worksurface top, standard in MFW White, see premium Metal Finish for options
- Hardwire infeed and jumpers are included in workstations
- T75 worksurface wire cutout is standard on all worksurfaces.(T75D: Delete cutout is optional)

Options

Accessories

- K28: Articulating Keyboard w/ Mouse - \$390
- K31-SK: Center drawer w/ skirt - \$310
- K31: Center drawer w/o skirt - \$205

Concealed Floor Power Infeed Cover

- PCEB: White Metal Finish concealed floor power infeed cover - \$150

Delete Top and Wire Tray

- DHAT: Delete height adjustable top. Deduct \$3845 Veneer(W), \$3644 High Pressure Laminate(G), \$3262 Thermally Fused Laminate(M) per top

Metal Feet

- MTL10: Replace solid wood feet with metal feet, standard MFW White - \$55 ea

Premium Metal Finish

- Specify premium Metal Finish. MFMB: Matte Black, MFS: Silver, MFSS: Salmon Sienna, MFSA: Surfing Aquavert, MFPS: Pistachio, MFOS: Oyster, MFNA: Navy, MFOL: Olive, MFGB: Grey Beige MFGG: Graphite Gray, MFG: Gray, MFGM: Matte Gold
- Premium Metal Finish for WMT Wire Management Tray - \$75 ea
- Premium Metal Finish for MTL10 Metal Feet - \$20 ea
- Premium Metal Finish for PCEB Concealed Floor Power Infeed Cover - \$35

Telecom Plates

- Each power unit has 1 plate. All telecom connectors sold separately.
- RJ45 (1) - \$55, RJ45 (2) - \$110, RJ45 (3) - \$165, USB (1) - \$70, USB (2) - \$140, RJ45/USB - \$125, RJ45/HDMI - \$210, HDMI/USB - \$205



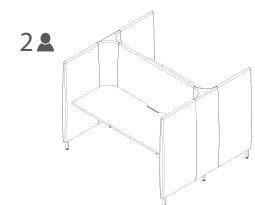

Number of Feet per Typical (MTL10 Option)

1 Select Model

Weight	Standard Veneer Top Upholstered Panels - COM\$
282 x 64 x 55	8 HNY28264FP560W 33458
212 x 64 x 55	6 HNY21264FP560W 25758
143 x 64 x 55	4 HNY14364FP560W 18058
73 x 64 x 55	2 HNY7364FP560W 10358

Premium Veneer Top Upholstered Panels - COM\$

"P" Option N/A  
"P" Option N/A  
"P" Option N/A  
"P" Option N/A

High Pressure Laminate Top Upholstered Panels - COM\$

HNY28264FP560G	31858
HNY21264FP560G	24558
HNY14364FP560G	17258
HNY7364FP560G	9958

Thermally Fused Laminate Top Upholstered Panels - COM\$

HNY28264FP560M	28802
HNY21264FP560M	22266
HNY14364FP560M	15730
HNY7364FP560M	9194

Product Features

- HNY6625WT162 Fixed Desk Height Worksurfaces are included
- 5" Solid wood feet - oval shape
- 4 Power outlets with 1 telecom plate, see options below for telecom plate
- Ships KD
- Wire management tray attaches to worksurface top, standard in MFW White, see premium Metal Finish for options
- Hardwire infeed and jumpers are included in workstations
- T75 worksurface wire cutout is standard on all worksurfaces.(T75D: Delete cutout is optional)

Options

Accessories

- K28: Articulating Keyboard w/ Mouse - \$390
- K31-SK: Center drawer w/ skirt - \$310
- K31: Center drawer w/o skirt - \$205

Concealed Floor Power Infeed Cover

- PCEB: White Metal Finish concealed floor power infeed cover - \$150

Delete Top and Wire Tray

- DFP: Delete fixed top. Deduct \$1535 Veneer (W), \$1335 High Pressure Laminate (G), \$953 Thermally Fused Laminate (M) per top

Metal Feet

- MTL10: Replace solid wood feet with metal feet, standard MFW White - \$55 ea

Premium Metal Finish

- Specify premium Metal Finish. MFMB: Matte Black, MFS: Silver, MFSS: Salmon Sienna, MFSA: SurfIn Aquavert, MFPS: Pistachio, MFOS: Oyster, MFNA: Navy, MFOL: Olive, MFGB: Grey Beige MFGG: Graphite Gray, MFG: Gray, MFGM: Matte Gold
- Premium Metal Finish for WMT Wire Management Tray - \$75 ea
- Premium Metal Finish for MTL10 Metal Feet - \$20 ea
- Premium Metal Finish for PCEB Concealed Floor Power Infeed Cover - \$35

Telecom Plates

- Each power unit has 1 plate. All telecom connectors sold separately.
- RJ45 (1) - \$55, RJ45 (2) - \$110, RJ45 (3) - \$165, USB (1) - \$70, USB (2) - \$140, RJ45/USB - \$125, RJ45/HDMI - \$210, HDMI/USB - \$205
- THL-42: Modify worksurface height to bar height - N/C

[Click Here for Graded in Pricing](#)

2 Select Finish

Click to view finishes

WWP	WOW
PO01	WNO
PO02	WSO
PO03	WNF(Natural Oak on Flat Cut)
PO07	WSF(Salted Oak on Flat Cut)
PO08	WSF(Salted Oak on Flat Cut)
PO09	WSW
WBW	WEC
WSW	
WEC	

3 Select Feet Finish

Click to view edges

WWP	WOW
PO01	WNO
PO02	WSO
PO03	
PO07	
PO08	
PO09	
WBW	
WSW	
WEC	

4 Select Edge

Click to view details

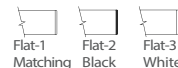
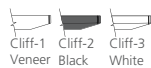

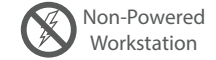
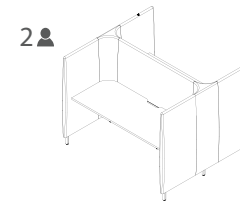

Number of Feet per Typical (MTL10 Option)

1 Select Model

w" x d" x h"	Weight	Standard Veneer Top Upholstered Panels - COM\$
282 x 64 x 55	8	HNY28264FT560W 30480
212 x 64 x 55	6	HNY21264FT560W 23477
143 x 64 x 55	4	HNY14364FT560W 16474
73 x 64 x 55	2	HNY7364FT560W 9471

Premium Veneer Top Upholstered Panels - COM\$

"P" Option N/A  
"P" Option N/A  
"P" Option N/A  
"P" Option N/A

High Pressure Laminate Top Upholstered Panels - COM\$

HNY28264FT560G	28880
HNY21264FT560G	22277
HNY14364FT560G	15674
HNY7364FT560G	9071

Thermally Fused Laminate Top Upholstered Panels - COM\$

HNY28264FT560M	25824
HNY21264FT560M	19985
HNY14364FT560M	14146
HNY7364FT560M	8307

Click here to view statement of line

Product Features

- HNY6625WT162 Fixed Desk Height Worksurfaces are included
- 5" Solid wood feet - oval shape
- Ships KD
- T75 worksurface wire cutout is standard on all worksurfaces.(T75D: Delete cutout is optional)

Options

Accessories

- K28: Articulating Keyboard w/ Mouse - \$390
- K31-SK: Center drawer w/ skirt - \$310
- K31: Center drawer w/o skirt - \$205

Delete Top

- DFT: Delete fixed top. Deduct \$1325 Veneer(W), \$1125 High Pressure Laminate (G), \$743 Thermally Fused Laminate (M) per top

Metal Feet

- MTL10: Replace solid wood feet with metal feet, standard MFW White - \$55 ea

Premium Metal Finish

- Specify premium Metal Finish. MFMB: Matte Black, MFS: Silver, MFSS: Salmon Sienna, MFSA: Surfing Aquavert, MFPS: Pistachio, MFOS: Oyster, MFNA: Navy, MFOL: Olive, MFGB: Grey Beige MFGG: Graphite Gray, MFG: Gray, MFGM: Matte Gold
- Premium Metal Finish for WMT Wire Management Tray - \$75 ea
- Premium Metal Finish for MTL10 Metal Feet - \$20 ea
- Premium Metal Finish for PCEB Concealed Floor Power Infeed Cover - \$35

Worksurface Height

- THL-42: Modify worksurface height to bar height - N/C

Wire Tray

- WMT: Wire metal tray. Mounts under top and comes standard in MFW White - \$210

[Click Here for Graded in Pricing](#)

2 Select Finish

Click to view finishes

WWP	WOW
PO01	WNO
PO02	WSO
PO03	WNF(Natural Oak on Flat Cut)
PO07	WSF(Salted Oak on Flat Cut)
PO08	WSF(Salted Oak on Flat Cut)
PO09	WSF(Salted Oak on Flat Cut)
WBW	
WSW	
WEC	

3 Select Feet Finish

Click to view edges

WWP	WOW
PO01	WNO
PO02	WSO
PO03	
PO07	
PO08	
PO09	
WBW	
WSW	
WEC	

4 Select Edge

Click to view details

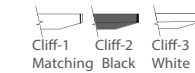
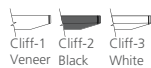

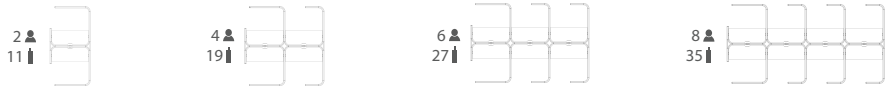

Number of Feet per Typical (MTL10 Option)

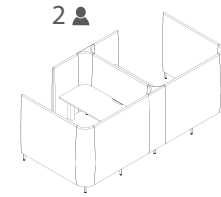

1 Select Model

Weight

w" x d" x h"	Standard Veneer Top Upholstered Panels - COM\$	Premium Veneer Top Upholstered Panels - COM\$	High Pressure Laminate Top Upholstered Panels - COM\$	Thermally Fused Laminate Top Upholstered Panels - COM\$
282 x 143 x 55	8 HNY282143HA561W 68712	"P" Option N/A	HNY282143HA561G 67104	HNY282143HA561M 64048
212 x 143 x 55	6 HNY212143HA561W 52414	"P" Option N/A	HNY212143HA561G 51208	HNY212143HA561M 48916
143 x 143 x 55	4 HNY143143HA561W 36116	"P" Option N/A	HNY143143HA561G 35312	HNY143143HA561M 33784
73 x 143 x 55	2 HNY73143HA561W 19818	"P" Option N/A	HNY73143HA561G 19416	HNY73143HA561M 18652

[Click Here for Graded in Pricing](#)

2 Select Finish

Click to view finishes

WWP	WOW
PO01	WNO
PO02	WSO
PO03	WNF(Natural Oak on Flat Cut)
PO07	WSF(Salted Oak on Flat Cut)
PO08	WSF(Salted Oak on Flat Cut)
PO09	WSF(Salted Oak on Flat Cut)
WBW	
WSW	
WEC	

3 Select Feet Finish

Click to view edges

WWP	WOW
PO01	WNO
PO02	WSO
PO03	
PO07	
PO08	
PO09	
WBW	
WSW	
WEC	

4 Select Edge

Click to view details



GEC	LW04
GNA +5%	LW05
GWL	LW06
LP01	
LF02	
LF03	
LN01	
LA02	
LW01	
LW02	

WWP	WOW
PO01	WNO
PO02	WSO
PO03	
PO07	
PO08	
PO09	
WBW	
WSW	
WEC	



MOC
MEC
MSW
MTW
MWL
MNA

WWP	WOW
PO01	WNO
PO02	WSO
PO03	
PO07	
PO08	
PO09	
WEC	
WBW	
WSW	



[Click here to view statement of line](#)

Product Features

- HNY6625WT163 Height Adjustable worksurfaces are included
- 5" Solid wood feet - oval shape
- 4 Power outlets with 1 telecom plate, see options below for telecom plate
- Ships KD
- Wire management tray attaches to worksurface top, standard in MFW White, see premium Metal Finish for options
- Hardwire infeed and jumpers are included in workstations
- T75 worksurface wire cutout is standard on all worksurfaces.(T75D: Delete cutout is optional)

Options

Accessories

- K28: Articulating Keyboard w/ Mouse - \$390
- K31-SK: Center drawer w/ skirt - \$310
- K31: Center drawer w/o skirt - \$205

Concealed Floor Power Infeed Cover

- PCEB: White Metal Finish concealed floor power infeed cover - \$150

Delete Top and Wire Tray

- DHAT: Delete height adjustable top. Deduct \$3845 Veneer(W), \$3644 High Pressure Laminate(G), \$3262 Thermally Fused Laminate(M) per top

Metal Feet

- MTL10: Replace solid wood feet with metal feet, standard MFW White - \$55 ea

Premium Metal Finish

- Specify premium Metal Finish. MFMB: Matte Black, MFS: Silver, MFSS: Salmon Sienna, MFSA: SurfIn Aquavert, MFPS: Pistachio, MFOS: Oyster, MFNA: Navy, MFOL: Olive, MFGB: Grey Beige MFGG: Graphite Gray, MFG: Gray, MFGM: Matte Gold
- Premium Metal Finish for WMT Wire Management Tray - \$75 ea
- Premium Metal Finish for MTL10 Metal Feet - \$20 ea
- Premium Metal Finish for PCEB Concealed Floor Power Infeed Cover - \$35

Telecom Plates

- Each power unit has 1 plate. All telecom connectors sold separately.
- RJ45 (1) - \$55, RJ45 (2) - \$110, RJ45 (3) - \$165, USB (1) - \$70, USB (2) - \$140, RJ45/USB - \$125, RJ45/HDMI - \$210, HDMI/USB - \$205

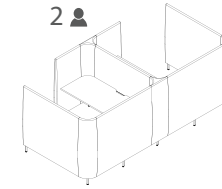
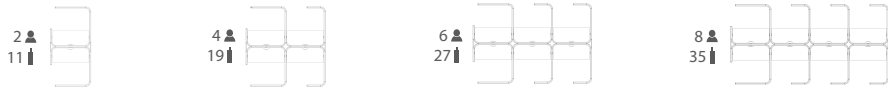

Fixed Top Workstation  
Powered Workstation

Number of Feet per Typical (MTL10 Option)

1 Select Model

Weight

Standard Veneer Top Upholstered Panels - COM\$

Premium Veneer Top Upholstered Panels - COM\$

High Pressure Laminate Top Upholstered Panels - COM\$

Thermally Fused Laminate Top Upholstered Panels - COM\$

w" x d" x h"	Weight	Standard Veneer Top Upholstered Panels - COM\$
282 x 143 x 55	8	HNY282143FP561W 50232
212 x 143 x 55	6	HNY212143FP561W 38554
143 x 143 x 55	4	HNY143143FP561W 26876
73 x 143 x 55	2	HNY73143FP561W 15198

"P" Option N/A  
"P" Option N/A  
"P" Option N/A  
"P" Option N/A

HNY282143FP561G	48632
HNY212143FP561G	37354
HNY143143FP561G	26076
HNY73143FP561G	14798

HNY282143FP561M	45576
HNY212143FP561M	35062
HNY143143FP561M	24548
HNY73143FP561M	14034

[Click here to view statement of line](#)

Product Features

- HNY6625WT162 Fixed Desk Height Worksurfaces are included
- 5" Solid wood feet - oval shape
- 4 Power outlets with 1 telecom plate, see options below for telecom plate
- Ships KD
- Wire management tray attaches to worksurface top, standard in MFW White, see premium Metal Finish for options
- Hardwire infeed and jumpers are included in workstations
- T75 worksurface wire cutout is standard on all worksurfaces.(T75D: Delete cutout is optional)

[Click Here for Graded in Pricing](#)

2 Select Finish

Click to view finishes

WWP	WOW
PO01	WNO
PO02	WSO
PO03	WNF(Natural Oak on Flat Cut)
PO07	WSF(Salted Oak on Flat Cut)
PO08	WSF(Salted Oak on Flat Cut)
PO09	WSF(Salted Oak on Flat Cut)
WBW	
WSW	
WEC	

GEC	LW04
GNA +5%	LW05
GWL	LW06
LP01	
LF02	
LF03	
LN01	
LA02	
LW01	
LW02	

MOC
MEC
MSW
MTW
MWL
MNA

Options

Accessories

- K28: Articulating Keyboard w/ Mouse - \$390
- K31-SK: Center drawer w/ skirt - \$310
- K31: Center drawer w/o skirt - \$205

Concealed Floor Power Infeed Cover

- PCEB: White Metal Finish concealed floor power infeed cover - \$150

Delete Top and Wire Tray

- DFP: Delete fixed top. Deduct \$1535 Veneer (W), \$1335 High Pressure Laminate (G), \$953 Thermally Fused Laminate (M) per top

Metal Feet

- MTL10: Replace solid wood feet with metal feet, standard MFW White - \$55 ea

Premium Metal Finish

- Specify premium Metal Finish. MFMB: Matte Black, MFS: Silver, MFSS: Salmon Sienna, MFSA: Surfing Aquavert, MFPS: Pistachio, MFOS: Oyster, MFNA: Navy, MFOL: Olive, MFGB: Grey Beige MFGG: Graphite Gray, MFG: Gray, MFGM: Matte Gold
- Premium Metal Finish for WMT Wire Management Tray - \$75 ea
- Premium Metal Finish for MTL10 Metal Feet - \$20 ea
- Premium Metal Finish for PCEB Concealed Floor Power Infeed Cover - \$35

Telecom Plates

- Each power unit has 1 plate. All telecom connectors sold separately.
- RJ45 (1) - \$55, RJ45 (2) - \$110, RJ45 (3) - \$165, USB (1) - \$70, USB (2) - \$140, RJ45/USB - \$125, RJ45/HDMI - \$210, HDMI/USB - \$205
- THL-42: Modify worksurface height to bar height - N/C

3 Select Feet Finish

Click to view edges

WWP	WOW
PO01	WNO
PO02	WSO
PO03	
PO07	
PO08	
PO09	
WBW	
WSW	
WEC	

WWP	WOW
PO01	WNO
PO02	WSO
PO03	
PO07	
PO08	
PO09	
WBW	
WSW	
WEC	

WWP	WOW
PO01	WNO
PO02	WSO
PO03	
PO07	
PO08	
PO09	
WEC	
WBW	
WSW	

4 Select Edge

Click to view details

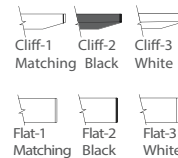
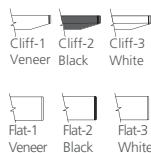

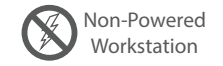
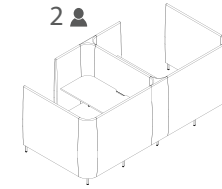
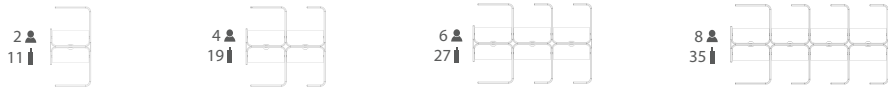

Number of Feet per Typical (MTL10 Option)

1 Select Model

Weight

Standard Veneer Top Upholstered Panels - COM\$

Premium Veneer Top Upholstered Panels - COM\$

High Pressure Laminate Top Upholstered Panels - COM\$

Thermally Fused Laminate Top Upholstered Panels - COM\$

w" x d" x h"	Weight	Standard Veneer Top Upholstered Panels - COM\$
282 x 143 x 55	8	HNY282143FT561W 46870
212 x 143 x 55	6	HNY212143FT561W 35985
143 x 143 x 55	4	HNY143143FT561W 25100
73 x 143 x 55	2	HNY73143FT561W 14215

"P" Option N/A  
"P" Option N/A  
"P" Option N/A  
"P" Option N/A

HNY282143FT561G	45270
HNY212143FT561G	34785
HNY143143FT561G	24300
HNY73143FT561G	13815

HNY282143FT561M	42214
HNY212143FT561M	32493
HNY143143FT561M	22772
HNY73143FT561M	13051

Product Features

- HNY6625WT162 Fixed Desk Height Worksurfaces are included
- 5" Solid wood feet - oval shape
- Ships KD
- T75 worksurface wire cutout is standard on all worksurfaces.(T75D: Delete cutout is optional)

Options

Accessories

- K28: Articulating Keyboard w/ Mouse - \$390
- K31-SK: Center drawer w/ skirt - \$310
- K31: Center drawer w/o skirt - \$205

Delete Top

- DFT: Delete fixed top. Deduct \$1325 Veneer(W), \$1125 High Pressure Laminate (G), \$743 Thermally Fused Laminate (M) per top

Metal Feet

- MTL10: Replace solid wood feet with metal feet, standard MFW White - \$55 ea

Premium Metal Finish

- Specify premium Metal Finish. MFMB: Matte Black, MFS: Silver, MFSS: Salmon Sienna, MFSA: Surfing Aquavert, MFPS: Pistachio, MFOS: Oyster, MFNA: Navy, MFOL: Olive, MFGB: Grey Beige MFGG: Graphite Gray, MFG: Gray, MFGM: Matte Gold
- Premium Metal Finish for WMT Wire Management Tray - \$75 ea
- Premium Metal Finish for MTL10 Metal Feet - \$20 ea
- Premium Metal Finish for PCEB Concealed Floor Power Infeed Cover - \$35

Worksurface Height

- THL-42: Modify worksurface height to bar height - N/C

Wire Tray

- WMT: Wire metal tray. Mounts under top and comes standard in MFW White - \$210

[Click Here for Graded in Pricing](#)

2 Select Finish

Click to view finishes

WWP	WOW
PO01	WNO
PO02	WSO
PO03	WNF(Natural Oak on Flat Cut)
PO07	WSF(Salted Oak on Flat Cut)
PO08	WSF(Salted Oak on Flat Cut)
PO09	WSF(Salted Oak on Flat Cut)
WBW	
WSW	
WEC	

3 Select Feet Finish

Click to view edges

WWP	WOW
PO01	WNO
PO02	WSO
PO03	
PO07	
PO08	
PO09	
WBW	
WSW	
WEC	

4 Select Edge

Click to view details

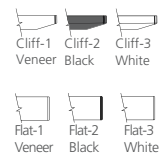



Number of Feet per Typical (MTL10 Option)

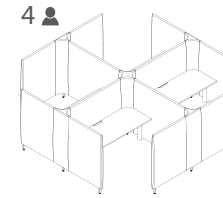

Height Adjustable Workstation



Powered Workstation

1 Select Model

Weight

w" x d" x h"  
282 x 143 x 55  
143 x 143 x 55

Standard Veneer Top Upholstered Panels - COM\$  
8 HNY282143HA563W 64592  
4 HNY143143HA563W 33508

Premium Veneer Top Upholstered Panels - COM\$  
"P" Option N/A  
"P" Option N/A

High Pressure Laminate Top Upholstered Panels - COM\$  
HNY282143HA563G 62984  
HNY143143HA563G 32704

Thermally Fused Laminate Top Upholstered Panels - COM\$  
HNY282143HA563M 59928  
HNY143143HA563M 31176

[Click here to view statement of line](#)

Product Features

- HNY6625WT163 Height Adjustable worksurfaces are included
- 5" Solid wood feet - oval shape
- 4 Power outlets with 1 telecom plate, see options below for telecom plate
- Ships KD
- Wire management tray attaches to worksurface top, standard in MFW White, see premium Metal Finish for options
- Hardwire infeed and jumpers are included in workstations
- T75 worksurface wire cutout is standard on all worksurfaces.(T75D: Delete cutout is optional)

[Click Here for Graded in Pricing](#)

2 Select Finish

Click to view finishes

WWP	WOW
PO01	WNO
PO02	WSO
PO03	WNF(Natural Oak on Flat Cut)
PO07	WSF(Salted Oak on Flat Cut)
PO08	
PO09	
WBW	
WSW	
WEC	

GEC	LW04
GNA +5%	LW05
GWL	LW06
LP01	
LF02	
LF03	
LN01	
LA02	
LW01	
LW02	

MOC
MEC
MSW
MTW
MWL
MNA

3 Select Feet Finish

Click to view edges

WWP	WOW
PO01	WNO
PO02	WSO
PO03	
PO07	
PO08	
PO09	
WBW	
WSW	
WEC	

WWP	WOW
PO01	WNO
PO02	WSO
PO03	
PO07	
PO08	
PO09	
WBW	
WSW	
WEC	

WWP	WOW
PO01	WNO
PO02	WSO
PO03	
PO07	
PO08	
PO09	
WEC	
WBW	
WSW	

4 Select Edge

Click to view details



Options

Accessories

- K28: Articulating Keyboard w/ Mouse - \$390
- K31-SK: Center drawer w/ skirt - \$310
- K31: Center drawer w/o skirt - \$205

Concealed Floor Power Infeed Cover

- PCEB: White Metal Finish concealed floor power infeed cover - \$150

Delete Top and Wire Tray

- DHAT: Delete height adjustable top. Deduct \$3845 Veneer(W), \$3644 High Pressure Laminate(G), \$3262 Thermally Fused Laminate(M) per top

Metal Feet

- MTL10: Replace solid wood feet with metal feet, standard MFW White - \$55 ea

Premium Metal Finish

- Specify premium Metal Finish. MFMB: Matte Black, MFS: Silver, MFSS: Salmon Sienna, MFSA: Surfing Aquavert, MFPS: Pistachio, MFOS: Oyster, MFNA: Navy, MFOL: Olive, MFGB: Grey Beige MFGG: Graphite Gray, MFG: Gray, MFGM: Matte Gold
- Premium Metal Finish for WMT Wire Management Tray - \$75 ea
- Premium Metal Finish for MTL10 Metal Feet - \$20 ea
- Premium Metal Finish for PCEB Concealed Floor Power Infeed Cover - \$35

Telecom Plates

- Each power unit has 1 plate. All telecom connectors sold separately.
- RJ45 (1) - \$55, RJ45 (2) - \$110, RJ45 (3) - \$165, USB (1) - \$70, USB (2) - \$140, RJ45/USB - \$125, RJ45/HDMI - \$210, HDMI/USB - \$205



Number of Feet per Typical (MTL10 Option)

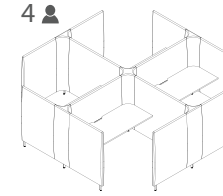

1 Select Model

Weight

w" x d" x h"  
282 x 143 x 55  
143 x 143 x 55

Standard Veneer Top  
Upholstered Panels - COM\$

8 HNY282143FP563W 46112  
4 HNY143143FP563W 24268

Premium Veneer Top  
Upholstered Panels - COM\$

"P" Option N/A  
"P" Option N/A

High Pressure Laminate Top  
Upholstered Panels - COM\$

HNY282143FP563G 44512  
HNY143143FP563G 23468

Thermally Fused Laminate Top  
Upholstered Panels - COM\$

HNY282143FP563M 41456  
HNY143143FP563M 21940

[Click here to view statement of line](#)

Product Features

- HNY6625WT162 Fixed Desk Height Worksurfaces are included
- 5" Solid wood feet - oval shape
- 4 Power outlets with 1 telecom plate, see options below for telecom plate
- Ships KD
- Wire management tray attaches to worksurface top, standard in MFW White, see premium Metal Finish for options
- Hardwire infeed and jumpers are included in workstations
- T75 worksurface wire cutout is standard on all worksurfaces.(T75D: Delete cutout is optional)

[Click Here for Graded in Pricing](#)

2 Select Finish

Click to view finishes

WWP	WOW
PO01	WNO
PO02	WSO
PO03	WNF(Natural Oak on Flat Cut)
PO07	WSF(Salted Oak on Flat Cut)
PO08	
PO09	
WBW	
WSW	
WEC	

GEC	LW04
GNA +5%	LW05
GWL	LW06
LP01	
LF02	
LF03	
LN01	
LA02	
LW01	
LW02	

MOC
MEC
MSW
MTW
MWL
MNA

3 Select Feet Finish

Click to view edges

WWP	WOW
PO01	WNO
PO02	WSO
PO03	
PO07	
PO08	
PO09	
WBW	
WSW	
WEC	

WWP	WOW
PO01	WNO
PO02	WSO
PO03	
PO07	
PO08	
PO09	
WBW	
WSW	
WEC	

WWP	WOW
PO01	WNO
PO02	WSO
PO03	
PO07	
PO08	
PO09	
WEC	
WBW	
WSW	

4 Select Edge

Click to view details



Options

Accessories

- K28: Articulating Keyboard w/ Mouse - \$390
- K31-SK: Center drawer w/ skirt - \$310
- K31: Center drawer w/o skirt - \$205

Concealed Floor Power Infeed Cover

- PCEB: White Metal Finish concealed floor power infeed cover - \$150

Delete Top and Wire Tray

- DFP: Delete fixed top. Deduct \$1535 Veneer (W), \$1335 High Pressure Laminate (G), \$953 Thermally Fused Laminate (M) per top

Metal Feet

- MTL10: Replace solid wood feet with metal feet, standard MFW White - \$55 ea

Premium Metal Finish

- Specify premium Metal Finish. MFMB: Matte Black, MFS: Silver, MFSS: Salmon Sienna, MFSA: Surfing Aquavert, MFPS: Pistachio, MFOS: Oyster, MFNA: Navy, MFOL: Olive, MFGB: Grey Beige MFGG: Graphite Gray, MFG: Gray, MFGM: Matte Gold
- Premium Metal Finish for WMT Wire Management Tray - \$75 ea
- Premium Metal Finish for MTL10 Metal Feet - \$20 ea
- Premium Metal Finish for PCEB Concealed Floor Power Infeed Cover - \$35

Telecom Plates

- Each power unit has 1 plate. All telecom connectors sold separately.
- RJ45 (1) - \$55, RJ45 (2) - \$110, RJ45 (3) - \$165, USB (1) - \$70, USB (2) - \$140, RJ45/USB - \$125, RJ45/HDMI - \$210, HDMI/USB - \$205
- THL-42: Modify worksurface height to bar height - N/C

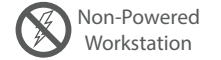
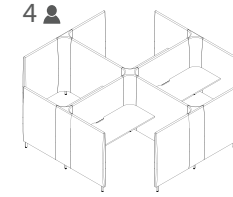
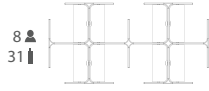

Number of Feet per Typical (MTL10 Option)

1 Select Model

Weight

w" x d" x h"  
282 x 143 x 55  
143 x 143 x 55

Standard Veneer Top Upholstered Panels - COM\$	
8 HNY282143FT563W	42742
4 HNY143143FT563W	22588

Premium Veneer Top Upholstered Panels - COM\$	
"P" Option N/A	
"P" Option N/A	

High Pressure Laminate Top Upholstered Panels - COM\$	
HNY282143FT563G	41142
HNY143143FT563G	21788

Thermally Fused Laminate Top Upholstered Panels - COM\$	
HNY282143FT563M	38086
HNY143143FT563M	20260

[Click here to view statement of line](#)

Product Features

- HNY6625WT162 Fixed Desk Height Worksurfaces are included
- 5" Solid wood feet - oval shape
- Ships KD
- T75 worksurface wire cutout is standard on all worksurfaces.(T75D: Delete cutout is optional)

Options

Accessories

- K28: Articulating Keyboard w/ Mouse - \$390
- K31-SK: Center drawer w/ skirt - \$310
- K31: Center drawer w/o skirt - \$205

Delete Top

- DFT: Delete fixed top. Deduct \$1325 Veneer(W), \$1125 High Pressure Laminate (G), \$743 Thermally Fused Laminate (M) per top

Metal Feet

- MTL10: Replace solid wood feet with metal feet, standard MFW White - \$55 ea

Premium Metal Finish

- Specify premium Metal Finish. MFMB: Matte Black, MFS: Silver, MFSS: Salmon Sienna, MFSA: Surfing Aquavert, MFPS: Pistachio, MFOS: Oyster, MFNA: Navy, MFOL: Olive, MFGB: Grey Beige MFGG: Graphite Gray, MFG: Gray, MFGM: Matte Gold
- Premium Metal Finish for WMT Wire Management Tray - \$75 ea
- Premium Metal Finish for MTL10 Metal Feet - \$20 ea
- Premium Metal Finish for PCEB Concealed Floor Power Infeed Cover - \$35

Worksurface Height

- THL-42: Modify worksurface height to bar height - N/C

Wire Tray

- WMT: Wire metal tray. Mounts under top and comes standard in MFW White - \$210

[Click Here for Graded in Pricing](#)

2 Select Finish

Click to view finishes

WWP	WOW
PO01	WNO
PO02	WSO
PO03	WNF(Natural Oak on Flat Cut)
PO07	WSF(Salted Oak on Flat Cut)
PO08	
PO09	
WBW	
WSW	
WEC	

3 Select Feet Finish

Click to view edges

WWP	WOW
PO01	WNO
PO02	WSO
PO03	
PO07	
PO08	
PO09	
WBW	
WSW	
WEC	

4 Select Edge

Click to view details

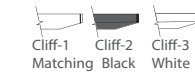
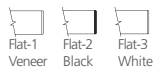



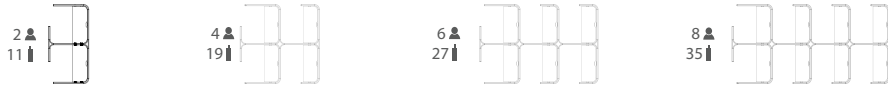

Number of Feet per Typical (MTL10 Option)

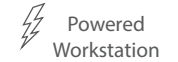
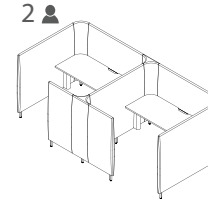

1 Select Model

Weight

w" x d" x h"  
282 x 143 x 55  
212 x 143 x 55  
143 x 143 x 55  
73 x 143 x 55

Standard Veneer Top  
Upholstered Panels - COM\$

8 HNY282143HA562W 71486  
6 HNY212143HA562W 54467  
4 HNY143143HA562W 37448  
2 HNY73143HA562W 20429

Premium Veneer Top  
Upholstered Panels - COM\$

"P" Option N/A  
"P" Option N/A  
"P" Option N/A  
"P" Option N/A

High Pressure Laminate Top  
Upholstered Panels - COM\$

HNY282143HA562G 69878  
HNY212143HA562G 53261  
HNY143143HA562G 36644  
HNY73143HA562G 20027

Thermally Fused Laminate Top  
Upholstered Panels - COM\$

HNY282143HA562M 66822  
HNY212143HA562M 50969  
HNY143143HA562M 35116  
HNY73143HA562M 19263

[Click here to view statement of line](#)

Product Features

- HNY6625WT163 Height Adjustable worksurfaces are included
- 5" Solid wood feet - oval shape
- 4 Power outlets with 1 telecom plate, see options below for telecom plate
- Ships KD
- Wire management tray attaches to worksurface top, standard in MFW White, see premium Metal Finish for options
- Hardwire infeed and jumpers are included in workstations
- T75 worksurface wire cutout is standard on all worksurfaces.(T75D: Delete cutout is optional)

[Click Here for Graded in Pricing](#)

2 Select Finish

Click to view finishes

WWP	WOW
PO01	WNO
PO02	WSO
PO03	WNF(Natural Oak on Flat Cut)
PO07	WSF(Salted Oak on Flat Cut)
PO08	
PO09	
WBW	
WSW	
WEC	

3 Select Feet Finish

Click to view edges

WWP	WOW
PO01	WNO
PO02	WSO
PO03	
PO07	
PO08	
PO09	
WBW	
WSW	
WEC	

4 Select Edge

Click to view details

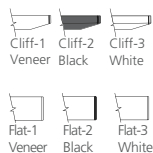

GEC	LW04
GNA +5%	LW05
GWL	LW06
LP01	
LF02	
LF03	
LN01	
LA02	
LW01	
LW02	

WWP	WOW
PO01	WNO
PO02	WSO
PO03	
PO07	
PO08	
PO09	
WBW	
WSW	
WEC	

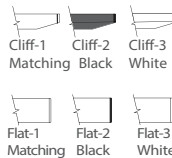

MOC
MEC
MSW
MTW
MWL
MNA

WWP	WOW
PO01	WNO
PO02	WSO
PO03	
PO07	
PO08	
PO09	
WEC	
WBW	
WSW	



Options

Accessories

- K28: Articulating Keyboard w/ Mouse - \$390
- K31-SK: Center drawer w/ skirt - \$310
- K31: Center drawer w/o skirt - \$205

Concealed Floor Power Infeed Cover

- PCEB: White Metal Finish concealed floor power infeed cover - \$150

Delete Top and Wire Tray

- DHAT: Delete height adjustable top. Deduct \$3845 Veneer(W), \$3644 High Pressure Laminate(G), \$3262 Thermally Fused Laminate(M) per top

Metal Feet

- MTL10: Replace solid wood feet with metal feet, standard MFW White - \$55 ea

Premium Metal Finish

- Specify premium Metal Finish. MFMB: Matte Black, MFS: Silver, MFSS: Salmon Sienna, MFSA: Surfin Aquavert, MFPS: Pistachio, MFOS: Oyster, MFNA: Navy, MFOL: Olive, MFGB: Grey Beige MFGG: Graphite Gray, MFG: Gray, MFGM: Matte Gold
- Premium Metal Finish for WMT Wire Management Tray - \$75 ea
- Premium Metal Finish for MTL10 Metal Feet - \$20 ea
- Premium Metal Finish for PCEB Concealed Floor Power Infeed Cover - \$35

Telecom Plates

- Each power unit has 1 plate. All telecom connectors sold separately.

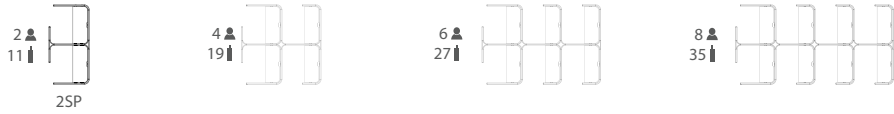

Number of Feet per Typical (MTL10 Option)

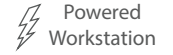

1 Select Model

Weight

w" x d" x h"  
282 x 143 x 55  
212 x 143 x 55  
143 x 143 x 55  
73 x 143 x 55

Standard Veneer Top Upholstered Panels - COM\$

8	HNY282143FP562W	53006
6	HNY212143FP562W	40607
4	HNY143143FP562W	28208
2	HNY73143FP562W	15809

Premium Veneer Top Upholstered Panels - COM\$

"P"	Option N/A
"P"	Option N/A
"P"	Option N/A
"P"	Option N/A

High Pressure Laminate Top Upholstered Panels - COM\$

HNY282143FP562G	51406
HNY212143FP562G	39407
HNY143143FP562G	27408
HNY73143FP562G	15409

Thermally Fused Laminate Top Upholstered Panels - COM\$

HNY282143FP562M	48350
HNY212143FP562M	37115
HNY143143FP562M	25880
HNY73143FP562M	14645

[Click here to view statement of line](#)

Product Features

- HNY6625WT162 Fixed Desk Height Worksurfaces are included
- 5" Solid wood feet - oval shape
- 4 Power outlets with 1 telecom plate, see options below for telecom plate
- Ships KD
- Wire management tray attaches to worksurface top, standard in MFW White, see premium Metal Finish for options
- Hardwire infeed and jumpers are included in workstations
- T75 worksurface wire cutout is standard on all worksurfaces.(T75D: Delete cutout is optional)

[Click Here for Graded in Pricing](#)

2 Select Finish

Click to view finishes

WWP	WOW
PO01	WNO
PO02	WSO
PO03	WNF(Natural Oak on Flat Cut)
PO07	WSF(Salted Oak on Flat Cut)
PO08	WSF(Salted Oak on Flat Cut)
PO09	WSF(Salted Oak on Flat Cut)
WBW	
WSW	
WEC	

GEC	LW04
GNA +5%	LW05
GWL	LW06
LP01	
LF02	
LF03	
LN01	
LA02	
LW01	
LW02	

MOC
MEC
MSW
MTW
MWL
MNA

3 Select Feet Finish

Click to view edges

WWP	WOW
PO01	WNO
PO02	WSO
PO03	
PO07	
PO08	
PO09	
WBW	
WSW	
WEC	

WWP	WOW
PO01	WNO
PO02	WSO
PO03	
PO07	
PO08	
PO09	
WBW	
WSW	
WEC	

WWP	WOW
PO01	WNO
PO02	WSO
PO03	
PO07	
PO08	
PO09	
WEC	
WBW	
WSW	

4 Select Edge

Click to view details



Options

Accessories

- K28: Articulating Keyboard w/ Mouse - \$390
- K31-SK: Center drawer w/ skirt - \$310
- K31: Center drawer w/o skirt - \$205

Concealed Floor Power Infeed Cover

- PCEB: White Metal Finish concealed floor power infeed cover - \$150

Delete Top and Wire Tray

- DFP: Delete fixed top. Deduct \$1535 Veneer (W), \$1335 High Pressure Laminate (G), \$953 Thermally Fused Laminate (M) per top

Metal Feet

- MTL10: Replace solid wood feet with metal feet, standard MFW White - \$55 ea

Premium Metal Finish

- Specify premium Metal Finish. MFMB: Matte Black, MFS: Silver, MFSS: Salmon Sienna, MFSA: Surfing Aquavert, MFPS: Pistachio, MFOS: Oyster, MFNA: Navy, MFOL: Olive, MFGB: Grey Beige MFGG: Graphite Gray, MFG: Gray, MFGM: Matte Gold
- Premium Metal Finish for WMT Wire Management Tray - \$75 ea
- Premium Metal Finish for MTL10 Metal Feet - \$20 ea
- Premium Metal Finish for PCEB Concealed Floor Power Infeed Cover - \$35

Telecom Plates

- Each power unit has 1 plate. All telecom connectors sold separately.
- RJ45 (1) - \$55, RJ45 (2) - \$110, RJ45 (3) - \$165, USB (1) - \$70, USB (2) - \$140, RJ45/USB - \$125, RJ45/HDMI - \$210, HDMI/USB - \$205
- THL-42: Modify worksurface height to bar height - N/C

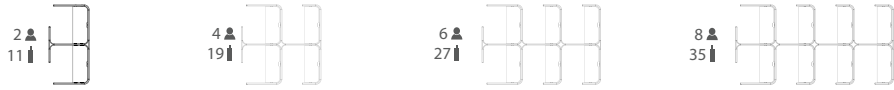

Number of Feet per Typical (MTL10 Option)

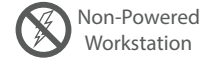

1 Select Model

Weight

w" x d" x h"	Standard Veneer Top Upholstered Panels - COM\$	Premium Veneer Top Upholstered Panels - COM\$	High Pressure Laminate Top Upholstered Panels - COM\$	Thermally Fused Laminate Top Upholstered Panels - COM\$
282 x 143 x 55	8 HNY282143FT562W 46870	"P" Option N/A	HNY282143FT562G 45270	HNY282143FT562M 42214
212 x 143 x 55	6 HNY212143FT562W 35985	"P" Option N/A	HNY212143FT562G 34785	HNY212143FT562M 32493
143 x 143 x 55	4 HNY143143FT562W 25100	"P" Option N/A	HNY143143FT562G 24300	HNY143143FT562M 22772
73 x 143 x 55	2 HNY73143FT562W 14215	"P" Option N/A	HNY73143FT562G 13815	HNY73143FT562M 13051

[Click Here for Graded in Pricing](#)

2 Select Finish

Click to view finishes

WWP	WOW
PO01	WNO
PO02	WSO
PO03	WNF(Natural Oak on Flat Cut)
PO07	WSF(Salted Oak on Flat Cut)
PO08	WSF(Salted Oak on Flat Cut)
PO09	WSF(Salted Oak on Flat Cut)
WBW	
WSW	
WEC	

3 Select Feet Finish

Click to view edges

WWP	WOW
PO01	WNO
PO02	WSO
PO03	
PO07	
PO08	
PO09	
WBW	
WSW	
WEC	

4 Select Edge

Click to view details



[Click here to view statement of line](#)

Product Features

- HNY6625WT162 Fixed Desk Height Worksurfaces are included
- 5" Solid wood feet - oval shape
- Ships KD
- T75 worksurface wire cutout is standard on all worksurfaces.(T75D: Delete cutout is optional)

Options

Accessories

- K28: Articulating Keyboard w/ Mouse - \$390
- K31-SK: Center drawer w/ skirt - \$310
- K31: Center drawer w/o skirt - \$205

Delete Top

- DFT: Delete fixed top. Deduct \$1325 Veneer(W), \$1125 High Pressure Laminate (G), \$743 Thermally Fused Laminate (M) per top

Metal Feet

- MTL10: Replace solid wood feet with metal feet, standard MFW White - \$55 ea

Premium Metal Finish

- Specify premium Metal Finish. MFMB: Matte Black, MFS: Silver, MFSS: Salmon Sienna, MFSA: Surfing Aquavert, MFPS: Pistachio, MFOS: Oyster, MFNA: Navy, MFOL: Olive, MFGB: Grey Beige MFGG: Graphite Gray, MFG: Gray, MFGM: Matte Gold
- Premium Metal Finish for WMT Wire Management Tray - \$75 ea
- Premium Metal Finish for MTL10 Metal Feet - \$20 ea
- Premium Metal Finish for PCEB Concealed Floor Power Infeed Cover - \$35

Worksurface Height

- THL-42: Modify worksurface height to bar height - N/C

Wire Tray

- WMT: Wire metal tray. Mounts under top and comes standard in MFW White - \$210



Number of Feet per Typical (MTL10 Option)

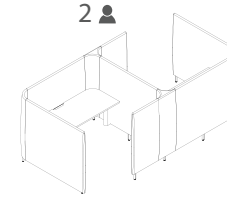

1 Select Model

Weight

w" x d" x h"  
143 x 143 x 55  
73 x 143 x 55

	Standard Veneer Top Upholstered Panels - COM\$
4	HNY143143HA564W 35732
2	HNY73143HA564W 20539

	Premium Veneer Top Upholstered Panels - COM\$
	"P" Option N/A
	"P" Option N/A

	High Pressure Laminate Top Upholstered Panels - COM\$
	HNY143143HA564G 34928
	HNY73143HA564G 20137

	Thermally Fused Laminate Top Upholstered Panels - COM\$
	HNY143143HA564M 33400
	HNY73143HA564M 19373

[Click here to view statement of line](#)

Product Features

- HNY6625WT163 Height Adjustable worksurfaces are included
- 5" Solid wood feet - oval shape
- 4 Power outlets with 1 telecom plate, see options below for telecom plate
- Ships KD
- Wire management tray attaches to worksurface top, standard in MFW White, see premium Metal Finish for options
- Hardwire infeed and jumpers are included in workstations
- T75 worksurface wire cutout is standard on all worksurfaces.(T75D: Delete cutout is optional)

[Click Here for Graded in Pricing](#)

2 Select Finish

Click to view finishes

WWP	WOW
PO01	WNO
PO02	WSO
PO03	WNF(Natural Oak on Flat Cut)
PO07	WSF(Salted Oak on Flat Cut)
PO08	
PO09	
WBW	
WSW	
WEC	

GEC	LW04
GNA +5%	LW05
GWL	LW06
LP01	
LF02	
LF03	
LN01	
LA02	
LW01	
LW02	

MOC
MEC
MSW
MTW
MWL
MNA

3 Select Feet Finish

Click to view edges

WWP	WOW
PO01	WNO
PO02	WSO
PO03	
PO07	
PO08	
PO09	
WBW	
WSW	
WEC	

WWP	WOW
PO01	WNO
PO02	WSO
PO03	
PO07	
PO08	
PO09	
WBW	
WSW	
WEC	

WWP	WOW
PO01	WNO
PO02	WSO
PO03	
PO07	
PO08	
PO09	
WEC	
WBW	
WSW	

4 Select Edge

Click to view details

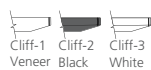

Options

Accessories

- K28: Articulating Keyboard w/ Mouse - \$390
- K31-SK: Center drawer w/ skirt - \$310
- K31: Center drawer w/o skirt - \$205

Concealed Floor Power Infeed Cover

- PCEB: White Metal Finish concealed floor power infeed cover - \$150

Delete Top and Wire Tray

- DHAT: Delete height adjustable top. Deduct \$3845 Veneer(W), \$3644 High Pressure Laminate(G), \$3262 Thermally Fused Laminate(M) per top

Metal Feet

- MTL10: Replace solid wood feet with metal feet, standard MFW White - \$55 ea

Premium Metal Finish

- Specify premium Metal Finish. MFMB: Matte Black, MFS: Silver, MFSS: Salmon Sienna, MFSA: Surfing Aquavert, MFPS: Pistachio, MFOS: Oyster, MFNA: Navy, MFOL: Olive, MFGB: Grey Beige MFGG: Graphite Gray, MFG: Gray, MFGM: Matte Gold
- Premium Metal Finish for WMT Wire Management Tray - \$75 ea
- Premium Metal Finish for MTL10 Metal Feet - \$20 ea
- Premium Metal Finish for PCEB Concealed Floor Power Infeed Cover - \$35

Telecom Plates

- Each power unit has 1 plate. All telecom connectors sold separately.

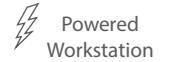
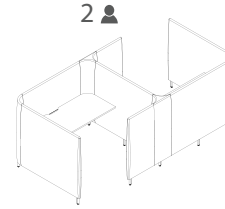

Number of Feet per Typical (MTL10 Option)

1 Select Model

Weight

w" x d" x h"	Standard Veneer Top Upholstered Panels - COM\$	Premium Veneer Top Upholstered Panels - COM\$	High Pressure Laminate Top Upholstered Panels - COM\$	Thermally Fused Laminate Top Upholstered Panels - COM\$
143 x 143 x 55	4 HNY143143FP564W 26492	"P" Option N/A	HNY143143FP564G 25692	HNY143143FP564M 24164
73 x 143 x 55	2 HNY73143FP564W 15919	"P" Option N/A	HNY73143FP564G 15519	HNY73143FP564M 14755

[Click Here for Graded in Pricing](#)

2 Select Finish

Click to view finishes

WWP	WOW
PO01	WNO
PO02	WSO
PO03	WNF(Natural Oak on Flat Cut)
PO07	WSF(Salted Oak on Flat Cut)
PO08	WSF(Salted Oak on Flat Cut)
PO09	WSF(Salted Oak on Flat Cut)
WBW	
WSW	
WEC	

3 Select Feet Finish

Click to view edges

WWP	WOW
PO01	WNO
PO02	WSO
PO03	
PO07	
PO08	
PO09	
WBW	
WSW	
WEC	

4 Select Edge

Click to view details

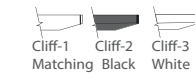
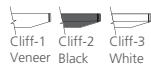

[Click here to view statement of line](#)

Product Features

- HNY6625WT162 Fixed Desk Height Worksurfaces are included
- 5" Solid wood feet - oval shape
- 4 Power outlets with 1 telecom plate, see options below for telecom plate
- Ships KD
- Wire management tray attaches to worksurface top, standard in MFW White, see premium Metal Finish for options
- Hardwire infeed and jumpers are included in workstations
- T75 worksurface wire cutout is standard on all worksurfaces.(T75D: Delete cutout is optional)

Options

Accessories

- K28: Articulating Keyboard w/ Mouse - \$390
- K31-SK: Center drawer w/ skirt - \$310
- K31: Center drawer w/o skirt - \$205

Concealed Floor Power Infeed Cover

- PCEB: White Metal Finish concealed floor power infeed cover - \$150

Delete Top and Wire Tray

- DFP: Delete fixed top. Deduct \$1535 Veneer (W), \$1335 High Pressure Laminate (G), \$953 Thermally Fused Laminate (M) per top

Metal Feet

- MTL10: Replace solid wood feet with metal feet, standard MFW White - \$55 ea

Premium Metal Finish

- Specify premium Metal Finish. MFMB: Matte Black, MFS: Silver, MFSS: Salmon Sienna, MFSA: Surfing Aquavert, MFPS: Pistachio, MFOS: Oyster, MFNA: Navy, MFOL: Olive, MFGB: Grey Beige MFGG: Graphite Gray, MFG: Gray, MFGM: Matte Gold
- Premium Metal Finish for WMT Wire Management Tray - \$75 ea
- Premium Metal Finish for MTL10 Metal Feet - \$20 ea
- Premium Metal Finish for PCEB Concealed Floor Power Infeed Cover - \$35

Telecom Plates

- Each power unit has 1 plate. All telecom connectors sold separately.
- RJ45 (1) - \$55, RJ45 (2) - \$110, RJ45 (3) - \$165, USB (1) - \$70, USB (2) - \$140, RJ45/USB - \$125, RJ45/HDMI - \$210, HDMI/USB - \$205
- THL-42: Modify worksurface height to bar height - N/C

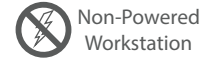
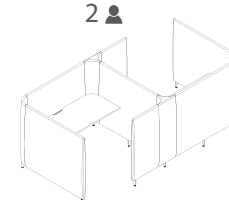

Number of Feet per Typical (MTL10 Option)

1 Select Model

Weight

w" x d" x h"	Standard Veneer Top Upholstered Panels - COM\$	Premium Veneer Top Upholstered Panels - COM\$
143 x 143 x 55	4 HNY143143FT564W 23322	"P" Option N/A
73 x 143 x 55	2 HNY73143FT564W 14215	"P" Option N/A

[Click Here for Graded in Pricing](#)

2 Select Finish

Click to view finishes

WWP	WOW
PO01	WNO
PO02	WSO
PO03	WNF(Natural Oak on Flat Cut)
PO07	WSF(Salted Oak on Flat Cut)
PO08	
PO09	
WBW	
WSW	
WEC	

3 Select Feet Finish

Click to view edges

WWP	WOW
PO01	WNO
PO02	WSO
PO03	
PO07	
PO08	
PO09	
WBW	
WSW	
WEC	

4 Select Edge

Click to view details

High Pressure Laminate Top Upholstered Panels - COM\$

HNY143143FT564G	22522
HNY73143FT564G	13815

GEC	LW04
GNA +5%	LW05
GWL	LW06
LP01	
LF02	
LF03	
LN01	
LA02	
LW01	
LW02	

WWP	WOW
PO01	WNO
PO02	WSO
PO03	
PO07	
PO08	
PO09	
WBW	
WSW	
WEC	



Thermally Fused Laminate Top Upholstered Panels - COM\$

HNY143143FT564M	20994
HNY73143FT564M	13051

MOC
MEC
MSW
MTW
MWL
MNA

WWP	WOW
PO01	WNO
PO02	WSO
PO03	
PO07	
PO08	
PO09	
WEC	
WBW	
WSW	



[Click here to view statement of line](#)

Product Features

- HNY6625WT162 Fixed Desk Height Worksurfaces are included
- 5" Solid wood feet - oval shape
- Ships KD
- T75 worksurface wire cutout is standard on all worksurfaces.(T75D: Delete cutout is optional)

Options

Accessories

- K28: Articulating Keyboard w/ Mouse - \$390
- K31-SK: Center drawer w/ skirt - \$310
- K31: Center drawer w/o skirt - \$205

Delete Top

- DFT: Delete fixed top. Deduct \$1325 Veneer(W), \$1125 High Pressure Laminate (G), \$743 Thermally Fused Laminate (M) per top

Metal Feet

- MTL10: Replace solid wood feet with metal feet, standard MFW White - \$55 ea

Premium Metal Finish

- Specify premium Metal Finish. MFMB: Matte Black, MFS: Silver, MFSS: Salmon Sienna, MFSA: Surfing Aquavert, MFPS: Pistachio, MFOS: Oyster, MFNA: Navy, MFOL: Olive, MFGB: Grey Beige MFGG: Graphite Gray, MFG: Gray, MFGM: Matte Gold
- Premium Metal Finish for WMT Wire Management Tray - \$75 ea
- Premium Metal Finish for MTL10 Metal Feet - \$20 ea
- Premium Metal Finish for PCEB Concealed Floor Power Infeed Cover - \$35

Worksurface Height

- THL-42: Modify worksurface height to bar height - N/C

Wire Tray

- WMT: Wire metal tray. Mounts under top and comes standard in MFW White - \$210

# Honey

90° Starter Panel  
Flat End

[Click here to view statement of line](#)

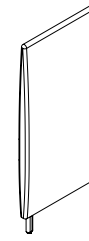

## 1 Model HNY2455SP908

w" x d" x h"  
24 x 3 x 55

COM	COL	1	2	3	4	5	6	7	8	9	10	11/L1	12	13/L2
959	N/A	1024	1056	1088	1120	1152	1184	1216	1248	1280	1312	1344	1376	1440

Upholstery Requirements  
Fabric yds: 1.75 Leather Sq. Ft.:N/A  
Carton Weight:15

## Product Features

- 5" Solid wood feet - oval shape

## Notes

- To configure workstations, customer is required to send drawing

## Options

### Metal Feet

- MTL10: Replace solid wood feet with metal feet, standard in MFW White - \$55 ea

### Premium Metal Finish

- Specify premium Metal Finish. MFMB: Matte Black, MFS: Silver, MFSS: Salmon Sienna, MFSA: Surfing Aquavert, MFPS: Pistachio, MFOS: Oyster, MFNA: Navy, MFOL: Olive, MFGB: Grey Beige MFGG: Graphite Gray, MFG: Gray, MFGM: Matte Gold  
- Premium Metal Finish for MTL10: Metal feet \$20 per foot

## 2 Select Finish

[Click to view finishes](#)

- WWP Designer White
- PO01 Olive on Oak
- PO02 Aquavert on Oak
- PO03 Mushroom on Oak
- PO07 Pebble on Oak
- PO08 Vapour on Oak
- PO09 Verde on Oak
- WEC Ebony
- WNO Natural Oak on Oak
- WSO Salted Oak on Oak
- WBW Henna Walnut on Walnut
- WSW Smokey Walnut on Walnut
- WOW Clear Walnut on Walnut

## 3 Combination Fabrics

[Click to view finishes](#)

Combination  
Fabric Option  
Not Available

# Honey

90° Starter Panel  
Flat End

[Click here to view statement of line](#)

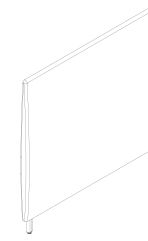

## 1 Model HNY5555SP909

w" x d" x h"  
54 x 3 x 55

COM	COL	1	2	3	4	5	6	7	8	9	10	11/L1	12	13/L2
1390	N/A	1520	1584	1648	1712	1776	1840	1904	1968	2032	2096	2160	2224	2352

Upholstery Requirements  
Fabric yds: 3.5 Leather Sq. Ft.:N/A  
Carton Weight:35

## Product Features

- 5" Solid wood feet - oval shape

## Notes

- To configure workstations, customer is required to send drawing

## Options

### Metal Feet

- MTL10: Replace solid wood feet with metal feet, standard in MFW White - \$55 ea

### Premium Metal Finish

- Specify premium Metal Finish. MFMB: Matte Black, MFS: Silver, MFSS: Salmon Sienna, MFSA: Surfing Aquavert, MFPS: Pistachio, MFOS: Oyster, MFNA: Navy, MFOL: Olive, MFGB: Grey Beige MFGG: Graphite Gray, MFG: Gray, MFGM: Matte Gold  
- Premium Metal Finish for MTL10: Metal feet \$20 per foot

## 2 Select Finish

[Click to view finishes](#)

- WWP Designer White
- PO01 Olive on Oak
- PO02 Aquavert on Oak
- PO03 Mushroom on Oak
- PO07 Pebble on Oak
- PO08 Vapour on Oak
- PO09 Verde on Oak
- WEC Ebony
- WNO Natural Oak on Oak
- WSO Salted Oak on Oak
- WBW Henna Walnut on Walnut
- WSW Smokey Walnut on Walnut
- WOW Clear Walnut on Walnut

## 3 Combination Fabrics

[Click to view finishes](#)

Combination  
Fabric Option  
Not Available



# Honey

90° Corner Panel Connector  
Two Way Corner Connector

[Click here to view statement of line](#)



## 1 Model HNY1055CP905

w" x d" x h"  
9.5 x 9.5 x 55

COM	COL	1	2	3	4	5	6	7	8	9	10	11/L1	12	13/L2
594	N/A	631	649	667	685	703	721	739	757	775	793	811	829	865

Upholstery Requirements  
Fabric yds: 1 Leather Sq. Ft.:N/A  
Carton Weight:10

## Product Features

- 5" Solid wood feet - oval shape

## Notes

- To configure workstations, customer is required to send drawing

## Options

### Metal Feet

- MTL10: Replace solid wood feet with metal feet, standard in MFW White - \$55 ea

### Premium Metal Finish

- Specify premium Metal Finish. MFMB: Matte Black, MFS: Silver, MFSS: Salmon Sienna, MFSA: Surfing Aquavert, MFPS: Pistachio, MFOS: Oyster, MFNA: Navy, MFOL: Olive, MFGB: Grey Beige MFGG: Graphite Gray, MFG: Gray, MFGM: Matte Gold  
- Premium Metal Finish for MTL10: Metal feet \$20 per foot

## 2 Select Finish

[Click to view finishes](#)

- WWP Designer White
- PO01 Olive on Oak
- PO02 Aquavert on Oak
- PO03 Mushroom on Oak
- PO07 Pebble on Oak
- PO08 Vapour on Oak
- PO09 Verde on Oak
- WEC Ebony
- WNO Natural Oak on Oak
- WSO Salted Oak on Oak
- WBW Henna Walnut on Walnut
- WSW Smokey Walnut on Walnut
- WOW Clear Walnut on Walnut

## 3 Combination Fabrics

[Click to view finishes](#)

Combination  
Fabric Option  
Not Available

# Honey

90° Corner Panel Connector  
 Three Way Corner Connector

[Click here to view statement of line](#)



**1 Model**  
**HNY1255CP906**

w" x d" x h"  
 12 x 9.5 x 55

COM	COL	1	2	3	4	5	6	7	8	9	10	11/L1	12	13/L2
819	N/A	893	929	965	1001	1037	1073	1109	1145	1181	1217	1253	1289	1361

Upholstery Requirements  
 Fabric yds: 2 Leather Sq. Ft.:N/A  
 Carton Weight:15

**Product Features**

- 5" Solid wood feet - oval shape

**Notes**

- To configure workstations, customer is required to send drawing

**Options**

**Metal Feet**

- MTL10: Replace solid wood feet with metal feet, standard in MFW White - \$55 ea

**Premium Metal Finish**

- Specify premium Metal Finish. MFMB: Matte Black, MFS: Silver, MFSS: Salmon Sienna, MFSA: Surfing Aquavert, MFPS: Pistachio, MFOS: Oyster, MFNA: Navy, MFOL: Olive, MFGB: Grey Beige MFGG: Graphite Gray, MFG: Gray, MFGM: Matte Gold  
 - Premium Metal Finish for MTL10: Metal feet \$20 per foot

**2 Select Finish**

[Click to view finishes](#)

- WWP Designer White
- PO01 Olive on Oak
- PO02 Aquavert on Oak
- PO03 Mushroom on Oak
- PO07 Pebble on Oak
- PO08 Vapour on Oak
- PO09 Verde on Oak
- WEC Ebony
- WNO Natural Oak on Oak
- WSO Salted Oak on Oak
- WBW Henna Walnut on Walnut
- WSW Smokey Walnut on Walnut
- WOW Clear Walnut on Walnut

**3 Combination Fabrics**

[Click to view finishes](#)

Combination  
 Fabric Option  
 Not Available

# Honey

90° Corner Panel Connector  
 Four Way Corner Connector

[Click here to view statement of line](#)



## 1 Model HNY1655CP907

w" x d" x h"  
 16 x 16 x 55

COM	COL	1	2	3	4	5	6	7	8	9	10	11/L1	12	13/L2
1087	N/A	1171	1212	1253	1294	1335	1376	1417	1458	1499	1540	1581	1622	1704

Upholstery Requirements  
 Fabric yds: 2.25 Leather Sq. Ft.:N/A  
 Carton Weight:20

## Product Features

- 5" Solid wood feet - oval shape

## Notes

- To configure workstations, customer is required to send drawing

## Options

### Metal Feet

- MTL10: Replace solid wood feet with metal feet, standard in MFW White - \$55 ea

### Premium Metal Finish

- Specify premium Metal Finish. MFMB: Matte Black, MFS: Silver, MFSS: Salmon Sienna, MFSA: Surfing Aquavert, MFPS: Pistachio, MFOS: Oyster, MFNA: Navy, MFOL: Olive, MFGB: Grey Beige MFGG: Graphite Gray, MFG: Gray, MFGM: Matte Gold  
 - Premium Metal Finish for MTL10: Metal feet \$20 per foot

## 2 Select Finish

[Click to view finishes](#)

- WWP Designer White
- PO01 Olive on Oak
- PO02 Aquavert on Oak
- PO03 Mushroom on Oak
- PO07 Pebble on Oak
- PO08 Vapour on Oak
- PO09 Verde on Oak
- WEC Ebony
- WNO Natural Oak on Oak
- WSO Salted Oak on Oak
- WBW Henna Walnut on Walnut
- WSW Smokey Walnut on Walnut
- WOW Clear Walnut on Walnut

## 3 Combination Fabrics

[Click to view finishes](#)

Combination  
 Fabric Option  
 Not Available

# Honey

90° Adder Panel  
No Power Access

[Click here to view statement of line](#)

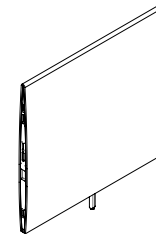

## 1 Model HNY5455AP904

w" x d" x h"  
53.5 x 3 x 55

COM	COL	1	2	3	4	5	6	7	8	9	10	11/L1	12	13/L2
1347	N/A	1477	1541	1605	1669	1733	1797	1861	1925	1989	2053	2117	2181	2309

Upholstery Requirements  
Fabric yds: 3.5 Leather Sq. Ft.:N/A  
Carton Weight:35

## Product Features

- 5" Solid wood feet - oval shape

## Notes

- To configure workstations, customer is required to send drawing  
- Panel overall height is 55" with feet. Panel overall height without feet is 50"

## Options

### Metal Feet

- MTL10: Replace solid wood feet with metal feet, standard in MFW White - \$55 ea

### Premium Metal Finish

- Specify premium Metal Finish. MFMB: Matte Black, MFS: Silver, MFSS: Salmon Sienna, MFSA: Surfin Aquavert, MFPS: Pistachio, MFOS: Oyster, MFNA: Navy, MFOL: Olive, MFGB: Grey Beige MFGG: Graphite Gray, MFG: Gray, MFGM: Matte Gold  
- Premium Metal Finish for MTL10: Metal feet \$20 per foot

## 2 Select Finish

[Click to view finishes](#)

- WWP Designer White
- PO01 Olive on Oak
- PO02 Aquavert on Oak
- PO03 Mushroom on Oak
- PO07 Pebble on Oak
- PO08 Vapour on Oak
- PO09 Verde on Oak
- WEC Ebony
- WNO Natural Oak on Oak
- WSO Salted Oak on Oak
- WBW Henna Walnut on Walnut
- WSW Smokey Walnut on Walnut
- WOW Clear Walnut on Walnut

## 3 Combination Fabrics

[Click to view finishes](#)

Combination  
Fabric Option  
Not Available

# Honey

90° Adder Panel  
Single Sided Access

[Click here to view statement of line](#)

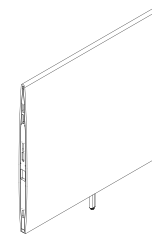

## 1 Model HNY5455AP910

w" x d" x h"  
53.5 x 3 x 55

COM	COL	1	2	3	4	5	6	7	8	9	10	11/L1	12	13/L2
1395	N/A	1525	1589	1653	1717	1781	1845	1909	1973	2037	2101	2165	2229	2357

Upholstery Requirements  
Fabric yds: 3.5 Leather Sq. Ft.:N/A  
Carton Weight:35

## 2 Select Finish

[Click to view finishes](#)

- WWP Designer White
- PO01 Olive on Oak
- PO02 Aquavert on Oak
- PO03 Mushroom on Oak
- PO07 Pebble on Oak
- PO08 Vapour on Oak
- PO09 Verde on Oak
- WEC Ebony
- WNO Natural Oak on Oak
- WSO Salted Oak on Oak
- WBW Henna Walnut on Walnut
- WSW Smokey Walnut on Walnut
- WOW Clear Walnut on Walnut

## 3 Combination Fabrics

[Click to view finishes](#)

Combination  
Fabric Option  
Not Available

## Product Features

- 5" Solid wood feet - oval shape
- Panel features access panel for wire management

## Notes

- To configure workstations, customer is required to send drawing
- Panel overall height is 55" with feet. Panel overall height without feet is 50"
- Removable panel allows wire access for cable management

## Options

### Metal Feet

- MTL10: Replace solid wood feet with metal feet, standard in MFW White - \$55 ea

### Premium Metal Finish

- Specify premium Metal Finish. MFMB: Matte Black, MFS: Silver, MFSS: Salmon Sienna, MFSA: Surfin Aquavert, MFPS: Pistachio, MFOS: Oyster, MFNA: Navy, MFOL: Olive, MFGB: Grey Beige MFGG: Graphite Gray, MFG: Gray, MFGM: Matte Gold
- Premium Metal Finish for MTL10: Metal feet \$20 per foot

# Honey

90° Single Sided Power Panel  
Power Panel

[Click here to view statement of line](#)

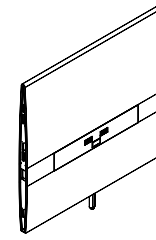

## 1 Model HNY5455PP911

w" x d" x h"  
53.5 x 3 x 55

COM	COL	1	2	3	4	5	6	7	8	9	10	11/L1	12	13/L2
1654	N/A	1784	1848	1912	1976	2040	2104	2168	2232	2296	2360	2424	2488	2616

Upholstery Requirements  
Fabric yds: 3.5 Leather Sq. Ft.:N/A  
Carton Weight:35

## 2 Select Finish

[Click to view finishes](#)

- WWP Designer White
- PO01 Olive on Oak
- PO02 Aquavert on Oak
- PO03 Mushroom on Oak
- PO07 Pebble on Oak
- PO08 Vapour on Oak
- PO09 Verde on Oak
- WEC Ebony
- WNO Natural Oak on Oak
- WSO Salted Oak on Oak
- WBW Henna Walnut on Walnut
- WSW Smokey Walnut on Walnut
- WOW Clear Walnut on Walnut

## 3 Combination Fabrics

[Click to view finishes](#)

Combination  
Fabric Option  
Not Available

## Product Features

- 5" Solid wood feet - oval shape
- 4 power outlets with 1 telecom plate, see options below for telecom plate

## Notes

- To configure workstations, customer is required to send drawing
- Panel overall height is 55" with feet. Panel overall height without feet is 50"
- Jumper(s) or hardwired infeed must be selected to power workstations. See options below.

## Options

### Metal Feet

- MTL10: Replace solid wood feet with metal feet, standard in MFW White - \$55 ea

### Jumper(s) and Infeed

- Specify Jumper or Infeed to power workstations
- JC70: 70" Length Jumper-Passes through corner post connecting 2 panels-\$180
- JC140: 140" Length Jumper-passes through one 54" added panel connecting 3 panels-\$270
- JC210: 210" Length Jumper-passes through (2) 53" added panels connecting 4 panels-\$360
- JC280: 280" Length Jumper- passes through (3) 53" added panels connecting 5 panels-\$450
- JC115: 115" Length Jumper-passes through one 34" adder panel connecting (3) panels-\$240
- CPF72: 72" corded power feed -\$275
- HPF192: 192" hardwired power feed -\$350

### Telecom Plates

- Each power unit has 1 plate. All telecom connectors sold separately.
- RJ45 (1) - \$55, RJ45 (2) - \$110, RJ45 (3) - \$165, USB (1) - \$70, USB (2) - \$140, RJ45/USB - \$125, RJ45/HDMI - \$210, HDMI/USB - \$205

# Honey

90° Double Sided Power Panel  
Power Panel

[Click here to view statement of line](#)

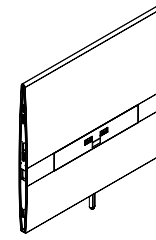

## 1 Model HNY5455PP912

w" x d" x h"  
53.5 x 3 x 55

COM	COL	1	2	3	4	5	6	7	8	9	10	11/L1	12	13/L2
1463	N/A	1593	1657	1721	1785	1849	1913	1977	2041	2105	2169	2233	2297	2425

Upholstery Requirements  
Fabric yds: 3.5 Leather Sq. Ft.:N/A  
Carton Weight:35

## 2 Select Finish

[Click to view finishes](#)

- WWP Designer White
- PO01 Olive on Oak
- PO02 Aquavert on Oak
- PO03 Mushroom on Oak
- PO07 Pebble on Oak
- PO08 Vapour on Oak
- PO09 Verde on Oak
- WEC Ebony
- WNO Natural Oak on Oak
- WSO Salted Oak on Oak
- WBW Henna Walnut on Walnut
- WSW Smokey Walnut on Walnut
- WOW Clear Walnut on Walnut

## 3 Combination Fabrics

[Click to view finishes](#)

Combination  
Fabric Option  
Not Available

## Product Features

- 5" Solid wood feet - oval shape
- Double sided power panel, each panel side features 4 power outlets with 1 telecom plate. See options below for telecom plate

## Notes

- To configure workstations, customer is required to send drawing
- Panel overall height is 55" with feet. Panel overall height without feet is 50"
- Jumper(s) or hardwired infeed must be selected to power workstations. See options below.

## Options

### Metal Feet

- MTL10: Replace solid wood feet with metal feet, standard in MFW White - \$55 ea

### Jumper(s) and Infeed

- Specify Jumper or Infeed to power workstations
- JC70:70" Length Jumper-Passes through corner post connecting 2 panels-\$180
- JC140: 140" Length Jumper-passes through one 54" added panel connecting 3 panels-\$270
- JC210: 210" Length Jumper-passes through (2) 53" added panels connecting 4 panels-\$360
- JC280: 280" Length Jumper- passes through (3) 53" added panels connecting 5 panels-\$450
- JC115: 115" Length Jumper-passes through one 34" adder panel connecting (3) panels-\$240
- CPF72: 72" corded power feed -\$275
- HPP192: 192" hardwired power feed -\$350

### Telecom Plates

- Each power unit has 1 plate. All telecom connectors sold separately.
- RJ45 (1) - \$55, RJ45 (2) - \$110, RJ45 (3) - \$165, USB (1) - \$70, USB (2) - \$140, RJ45/USB - \$125, RJ45/HDMI - \$210, HDMI/USB - \$205



Panels  
not included

[Click here to view statement of line](#)

**Product Features**

- 1" Thick top
- Bar height 42", desk height 29"
- Ships KD
- T75 worksurface wire cutout is standard on all worksurfaces.(T75D: Delete cutout is optional)

**Notes**

- PANELS NOT INCLUDED

**Options**

**Wire Tray / Premium Metal Finish**

- WMT: Wire metal tray. Mounts under top and comes standard in MFW White - \$210

**Premium Metal Finish**

- Specify premium Metal Finish. MFMB: Matte Black, MFS: Silver, MFSS: Salmon Sienna, MFSA: Surfin Aquavert, MFPS: Pistachio, MFOS: Oyster, MFNA: Navy, MFOL: Olive, MFGB: Grey Beige MFGG: Graphite Gray, MFG: Gray, MFGM: Matte Gold
- Premium Metal Finish for WMT wire management tray - \$75 ea

**1 Select Model**

Weight

Standard Veneer Top

Premium Veneer Top

High Pressure Laminate Top

Thermally Fused Laminate Top

w" x d" x h"	Weight	Standard Veneer Top	Premium Veneer Top
Bar Height 42"			
67 x 26 x 1	55	HNY6726WT160W 1325	"P" Option N/A
47 x 26 x 1	50	HNY4726WT160W 1259	"P" Option N/A
Desk Height 29"			
67 x 26 x 1	55	HNY6726WT162W 1325	"P" Option N/A
47 x 26 x 1	50	HNY4726WT162W 1259	"P" Option N/A

**2 Select Finish**

[Click to view finishes](#)

WWP	WOW
PO01	WNO
PO02	WSO
PO03	WNF(Natural Oak on Flat Cut)
PO07	WSF(Salted Oak on Flat Cut)
PO08	
PO09	
WBW	
WSW	
WEC	

**3 Select Feet Finish**

[Click to view edges](#)

**4 Select Edge**

[Click to view details](#)





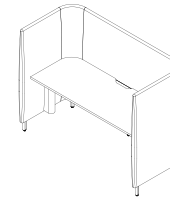

Panels  
not included

[Click here to view statement of line](#)

**Product Features**

- Worksurfaces are 1" thick.
- Lift standard in MFW White, optional MFB Black
- Ships KD
- Wire management tray attaches to worksurface top, standard in MFW White, see premium Metal Finish for options

**Notes**

- 1" Gap between worksurface and panels to drop wires below worksurface
- Metal parts include 5 year warranty
- Programmable height adjustable mechanism, motor includes 2 year warranty
- Height adjustable top with mechanism and wire tray only, panels not included

**Options**

**Premium Metal Finish**

- Specify premium Metal Finish. MFMB: Matte Black, MFS: Silver, MFSS: Salmon Sienna, MFSA: SurfIn Aquavert, MFPS: Pistachio, MFOS: Oyster, MFNA: Navy, MFOL: Olive, MFGB: Grey Beige MFGG: Graphite Gray, MFG: Gray, MFGM: Matte Gold
- Premium Metal Finish for WMT wire management tray - \$75 ea

**1 Select Model**

Weight

Standard Veneer Top

Premium Veneer Top

High Pressure Laminate Top

Thermally Fused Laminate Top

w" x d" x h"	Weight	Standard Veneer Top	Premium Veneer Top
66 X 25 X 1	110	HNY6727WT163W 3845	"P" Option N/A
46 X 25 X 1	100	HNY4727WT163W 3780	"P" Option N/A

"P" Option N/A  
"P" Option N/A

HNY6727WT163G	3644
HNY4727WT163G	3601

HNY6727WT163M	3262
HNY4727WT163G	3229

**2 Select Finish**

[Click to view finishes](#)

WWP	WOW
PO01	WNO
PO02	WSO
PO03	WNF(Natural Oak on Flat Cut)
PO07	WSF(Salted Oak on Flat Cut)
PO08	
PO09	
WBW	
WSW	
WEC	

GEC	LW05
GWL	LW06
LP01	
LF02	
LF03	
LN01	
LA02	
LW01	
LW02	
LW04	

MOC
MEC
MSW
MTW
MWL
MNA

**3 Select Feet Finish**

[Click to view edges](#)

**4 Select Edge**

[Click to view details](#)

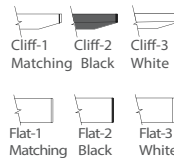
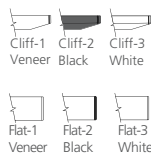

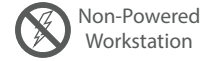
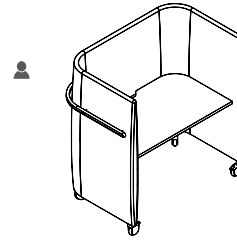

**1 Select Model**

w" x d" x h"	Weight
73 x 34 x 55	200
54 x 34 x 55	180

Standard Veneer Top Upholstered Panels - COM\$	
HNY7334FT569W	6580
HNY5434FT569W	6140

Premium Veneer Top Upholstered Panels - COM\$	
"P" Option N/A	
"P" Option N/A	

High Pressure Laminate Top Upholstered Panels - COM\$	
HNY7334FT569G	6380
HNY5434FT569G	5963

Thermally Fused Laminate Top Upholstered Panels - COM\$	
HNY7334FT659M	5998
HNY5434FT659M	5591

[Click here to view statement of line](#)

**Product Features**

- T75 worksurface wire cutout is standard on all worksurfaces.(T75D: Delete cutout is optional)
- Wood hand rails around outside mounted on wood standoffs
- HNY6726WT160 Fixed Desk Height worksurfaces, 29" worksurface height
- Ships KD

**Options**

**Accessories**

- K28: Articulating Keyboard w/ Mouse - \$390
- K31-SK: Center drawer w/ skirt - \$310
- K31: Center drawer w/o skirt - \$205

**Casters**

- 2 locking and 2 non-locking casters. Available in BK: Black (standard) or GR: Grey (optional)

**Wire Tray**

- WMT: Wire metal tray. Mounts under top and comes standard in MFW White - \$210

**Premium Metal Finish**

- Specify premium Metal Finish. MFMB: Matte Black, MFS: Silver, MFSS: Salmon Sienna, MFSA: SurfIn Aquavert, MFPS: Pistachio, MFOS: Oyster, MFNA: Navy, MFOL: Olive, MFGB: Grey Beige MFGG: Graphite Gray, MFG: Gray, MFGM:Matte Gold
- Premium Metal Finish for WMT Wire Management Tray - \$75 ea

**Tully Inline Power**

- PD-TULLY-IN-72: 2 power/dual USB up, 4 power down, 72" power cord - \$660
- PD-TULLY-IN-120: 2 power/dual USB up, 4 power down, 120" power cord - \$682

[Click Here for Graded in Pricing](#)

**2 Select Finish**

[Click to view finishes](#)

**Top Finishes**

WWP	WNO
PO01	WSO
PO02	WEC
PO03	WNF(Natural Oak on Flat Cut)
PO07	WSF(Salted Oak on Flat Cut)
PO08	
PO09	
WBW	
WSW	
WOW	

**Top Finishes**

- GEC
- GNA +5%
- GWL
- LP01
- LF02
- LF03
- LN01
- LA02
- LW01
- LW02
- LW04
- LW05
- LW06

**Top Finishes**

- MOC
- MEC
- MSW
- MTW
- MWL
- MNA

**3 Select Feet Finish**

[Click to view edges](#)

**4 Select Edge**

[Click to view details](#)



1 

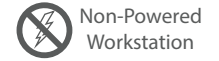
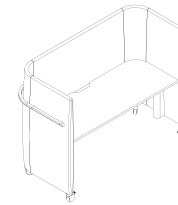

**1 Select Model**

w" x d" x h"	Weight	Standard Veneer Top Upholstered Panels - COM\$	Premium Veneer Top Upholstered Panels - COM\$
73 x 34 x 55	245	HNY7334HA569W 9100	"P" Option N/A
54 x 34 x 55	225	HNY5434HA569W 8660	"P" Option N/A

[Click Here for Graded in Pricing](#)

**2 Select Finish**

Click to view finishes

**Top Finishes**

WWP	WNO
PO01	WSO
PO02	WEC
PO03	WNF(Natural Oak on Flat Cut)
PO07	WSF(Salted Oak on Flat Cut)
PO08	WSF(Salted Oak on Flat Cut)
PO09	
WBW	
WSW	
WOW	

**3 Select Feet Finish**

Click to view edges

**4 Select Edge**

Click to view details



Premium Veneer Top Upholstered Panels - COM\$

"P" Option N/A  
"P" Option N/A

High Pressure Laminate Top Upholstered Panels - COM\$

HNY7334HA569G 8899  
HNY5434HA569G 8482

**Top Finishes**

GEC LW06  
GNA +5%  
GWL  
LP01  
LF02  
LF03  
LN01  
LA02  
LW01  
LW02  
LW04  
LW05



Thermally Fused Laminate Top Upholstered Panels - COM\$

HNY7334HA569M 8517  
HNY5434HA569M 8110

**Top Finishes**

MOC  
MEC  
MSW  
MTW  
MWL  
MNA



[Click here to view statement of line](#)

**Product Features**

- 1" Gap between worksurface and panels to drop wires below worksurface
- Programmable height adjustable mechanism, motor includes 2 year warranty
- Wood hand rails around outside mounted on wood standoffs
- 2 locking and 2 non-locking casters. Available in BK: Black (standard) or GR: Grey (optional)
- Adjustable height from 27" to 47.5" with a maximum weight capacity of 275 lbs. Lift standard in MFW White, optional MFB Black
- HNY6625WT163 Height Adjustable worksurfaces is included
- Wire management tray attaches to worksurface top, standard in MFW White, see premium Metal Finish for options
- T75 worksurface wire cutout is standard on all worksurfaces.(T75D: Delete cutout is optional)

**Options**

**Accessories**

- K28: Articulating Keyboard w/ Mouse - \$390
- K31-SK: Center drawer w/ skirt - \$310
- K31: Center drawer w/o skirt - \$205

**Castors**

- 2 locking and 2 non-locking casters. Available in BK: Black (standard) or GR: Grey (optional)

**Premium Metal Finish**

- Specify premium Metal Finish. MFMB: Matte Black, MFS: Silver, MFSS: Salmon Sienna, MFSA: Surfing Aquavert, MFPS: Pistachio, MFOS: Oyster, MFNA: Navy, MFOL: Olive, MFGB: Grey Beige MFGG: Graphite Gray, MFG: Gray, MFGM:Matte Gold
- Premium Metal Finish for WMT Wire Management Tray - \$75 ea
- Premium Metal Finish for PCEB Concealed Floor Power Infeed Cover - \$35

**Tully Inline Power**

- PD-TULLY-IN-72: 2 power/dual USB up, 4 power down, 72" power cord - \$660
- PD-TULLY-IN-120: 2 power/dual USB up, 4 power down, 120" power cord - \$682

# Honey

90° Worksurface Privacy Screen  
 Worksurface PET Privacy Screen

[Click here to view statement of line](#)

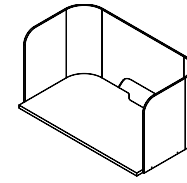

Top  
not included

## 1 Select Model

w" x d" x h"	Weight
46 x 23 x 24	10
66 x 23 x 24	10

Worksurface Screen		PET	
PS46	475		
PS66	495		

## Product Features

- Screen attaches to worksurface top
- PET Screen 1/2" thick with rounded corners
- Composed of 100% polyester fiber
- 50% post-consumer recycled content
- Adds additional acoustical absorption

## Notes

- Available on both 47" and 67" worksurfaces
- Only available on Height Adjustable Worksurfaces

## 2 Select Finish

[Click to view finishes](#)      Finish N/A

## 3 Select Edge

[Click to view edges](#)      Edge N/A

## Select acoustic color

- [Click to view details](#)
- Light Gray 3
  - Deep Blue 9
  - Dark Gray 17
  - Pure Gray 34
  - Berry Red 36
  - Ivory 44
  - Emerald 47
  - Smoky Beige 53
  - Heathered Granite 71
  - Heathered Oatmeal 75

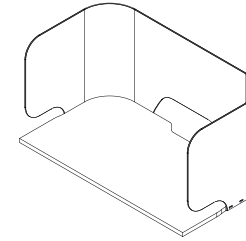

Top  
not included

1 Select Model

w" x d" x h"  
46 x 24 x 24

Weight

20

Worksurface Screen  
Frosted Acrylic

AS46AF

1679

Worksurface Screen  
Matte White Acrylic

AS46AW

1804

Worksurface Screen  
Matte Black Acrylic

AS46AB

1804

2 Select Finish

Click to view finishes

AF

AW

AB

3 Select Feet Finish

Click to view edges

4 Select Edge

Click to view details



Flat



Flat



Flat

[Click here to view statement of line](#)

Product Features

- Acrylic screens with rounded corners
- 1/4" Thick screen
- Screen attaches to worksurface top

Notes

- Matte acrylic is not a writable surface
- Available on 46" wide 90° worksurfaces
- Only available on Height Adjustable Worksurfaces

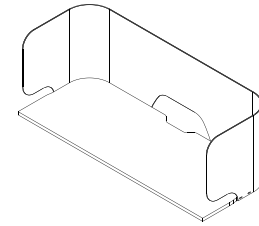

Top  
not included

1 Select Model

w" x d" x h"  
66 x 24 x 24

Weight  
20

Worksurface Screen  
Frosted Acrylic  
AS66AF 1897

Worksurface Screen  
Matte White Acrylic  
AS66AW 2022

Worksurface Screen  
Matte Black Acrylic  
AS66AB 2022

2 Select Finish

Click to view finishes

AF

AW

AB

3 Select Feet Finish

Click to view edges

4 Select Edge

Click to view details



[Click here to view statement of line](#)

Product Features

- Acrylic screens with rounded corners
- 1/4" Thick screen
- Screen attaches to worksurface top

Notes

- Matte acrylic is not a writable surface
- Available on 66" wide 90° worksurfaces
- Only available on Height Adjustable Worksurfaces

# DARRAN®

## Zip Wire Manager

Style Number	List Price
WMS1 - Fabric	\$77
WMS3 - Neoprene	\$88

## Specifications

- > Dimensions: 30" x 1.5" diameter
- > Attaches to wire basket
- > Zips up, bundles and routes loose, messy cables into a single tube
- > Routes and guides cables from Honey height adjustable worksurface to power panel
- > Accommodates large or small cables, up to 10 cords at once
- > WMS1: Fabric wire manager matches panel fabric. Not sold separately from panels.
- > WMS3 : Neoprene wire manager

Available: Honey



Fabric Sleeve  
WMS1



Neoprene Sleeve  
WMS3

## Honey Options

Wire Management Sleeve



## Neoprene Colors



White



Black



Gray

# DARRAN®

## Worksurface Reconfiguration Cover

Style Number                      List Price  
 HBC: 4 Worksurface Reconfiguration Covers    \$109

Honey has the ability to adapt with your office as you modify seating positions. The panels can be reconfigured to allow additional workspaces or to modify workspaces to lounge areas. When workspaces are attached to a panel, mounting is required. The Worksurface Reconfiguration Covers allow those mounting positions to be concealed. These covers simply press fit into the Honey panels.

Available: Honey

## Standard Colors

STANDARD                      OPTIONAL



MFW White  
 Satin Finish  
 (Standard)



MFB Black  
 Satin Finish  
 (Optional - N/C)

## Premium Colors - \$15



MFQ Gray  
 Satin Finish  
 (Premium)



MFGG Graphite Gray  
 Matte Finish  
 (Premium)



MFS Silver  
 Satin Finish  
 (Premium)



MFMB Matte Black  
 Matte Finish  
 (Premium)



MFNA Navy  
 Matte Finish  
 (Premium)



MFOL Olive  
 Matte Finish  
 (Premium)



MFGB Grey Beige  
 Matte Finish  
 (Premium)



MFSA Surfin Aquavert  
 Matte Finish  
 (Premium)



MFOS Oyster  
 Matte Finish  
 (Premium)



MFPS Pistachio  
 Matte Finish  
 (Premium)



MFSS Salmon Sienna  
 Matte Finish  
 (Premium)

## Honey Options



Worksurface Reconfiguration  
 Covers



# DARRAN®

## Trek Desktop LED Task Light

Style Number	List Price
TSATL-CM Clamp Mount	\$584
TSATL-SM Surface Mount	\$556
TSATL-FBU Freestanding Base w/ USB	\$693
Trek - Includes 9.5" Extended Arm	
TDATL-CM Clamp Mount	\$649
TDATL-SM Surface Mount	\$622
TDATL-FBU Freestanding Base w/ USB	\$758
HTLOCS - Occupancy sensor, option	\$93

\*Surface Mount application requires field installation, 2-1/8" grommet hole bored on site.

## Specifications

- › Made with fully-recyclable aluminum and plastic.
- › ENERGY CONSUMPTION: 7.2 system watts; 13.5 system watts with USB
- › NUMBER OF LEDS: 18 fractional LEDs
- › LIGHT OUTPUT: 294 lumens
- › EFFICACY: 41 Lm/W
- › LED RATED LIFESPAN: > 50,000 hours
- › COLOR TEMPERATURE: 3500K
- › COLOR RENDERING INDEX: 85
- › BRIGHTNESS ADJUSTABILITY: 100%–15% continuous
- › AUTO SHUT OFF: after 10 hours
- › USB CHARGE PORT: dedicated Type-A connector 5V, 1.2A max
- › POWER SUPPLY: 18-watt wall transformer with 9' black cord
- › CORD: 3' silver cord with quick connector
- › ETL listed: compliant to UL 153/8750 & CSA C22.2, No. 250.4; FCC Part 15 Class B; TAA; BAA; CEC Title 20
- › WARRANTY: 10 years fixture, 5 years power supply

Available: All DARRAN collections



Trek  
Includes 9.5" Extended Arm



Trek  
No Extended Arm



## Honey Options



Surface Mount



Clamp Mount



Freestanding with USB Mount

## Select Finish Color



# DARRAN®

## Coat Hook

Style Number	List Price
HSCH (Single Sided)	\$104
HDCH (Double Sided)	\$153

## Specifications

- > Decorative finished coat hook, select veneer finish for knob.
- > Available in White or Black Standard Metal Finish. Premium finishes are available.
- > Coat hook slides into position on the tops of the Honey panel system and can be easily repositioned.
- > Available in single or double sided coat hook.
- > Each knob can hold weight up to 50lbs.

Note:  
Signage Company can add vinyl lettering to feature a persons name, logo etc.

Available: Honey

## Standard Colors - Available in single or double sided coat hook



MFW White  
Satin Finish  
(Standard)

MFB Black  
Satin Finish  
(Optional - N/C)

## Premium Colors - +\$25



MFG Gray  
Satin Finish  
(Premium)

MFGB Graphite Gray  
Matte Finish  
(Premium)

MFS Silver  
Satin Finish  
(Premium)

MFMB Matte Black  
Matte Finish  
(Premium)

MFNA Navy  
Matte Finish  
(Premium)

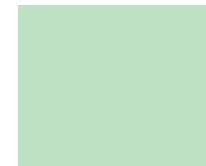
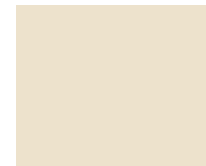

MFOL Olive  
Matte Finish  
(Premium)

MFGB Grey Beige  
Matte Finish  
(Premium)

MFSA Surfing Aquavert  
Matte Finish  
(Premium)

MFOS Oyster  
Matte Finish  
(Premium)

MFPS Pistachio  
Matte Finish  
(Premium)

MFSS Salmon Sienna  
Matte Finish  
(Premium)

## Honey Options



Single Sided Coat Hook



Double Sided Coat Hook

## Wood Finish for Knob

- PO01 Olive
- PO02 Aquave
- PO03 Mushroom
- PO07 Pebble
- PO08 Vapour
- PO09 Verde
- PM01 Olive
- PM02 Aquavert
- PM03 Mushroom
- PM07 Pebble
- PM08 Vapour
- PM10 Verde
- WOW Clear Walnut
- WNO Natural Oak
- WSO Salted Oak
- WBW Henna Walnut
- WSW Smokey Walnut
- WWP Designer White

# DARRAN®

## Rotating Bag Hook

Style Number  
HPH

List Price  
\$55

## Specifications

- › 360° swivel rotation
- › Under surface mounted
- › Holds up to 25lbs
- › Notched grooves in the base provide four stop points at 90 degree intervals where hook clicks into place while rotating.

Available: All DARRAN collections

## Standard Finishes

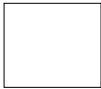

White



Black

## Honey Options



# DARRAN®

## Hanging Leather Storage Pocket

Style Number	List Price
HSSB (Single Sided)	\$279
HDSB (Double Sided)	\$436

## Specifications

- > Store and organize paperwork for easy access.
- > Pricing includes Green Hides Lena Leather. Must specify color or specify customers own leather (HSSB requires 3.5 sqft. HDSB requires 7 sqft.)
- > Metal hooks available in White or Black Standard Metal Finish. Premium finishes are available.
- > Hanging Leather Storage Pockets offered in single and double sided.
- > Hanging Leather Storage Pocket slides into position on the tops of the Honey panel system and can be easily repositioned.
- > Can hold up to 20lbs.

Note:  
Signage Company can add vinyl lettering to feature a persons name, logo etc.

Available: Honey

## Standard Colors (Metal)



MFW White  
Satin Finish  
(Standard)

MFB Black  
Satin Finish  
(Optional - N/C)

[Click here to view Green Hides Lena Leather](#)

## Premium Colors - +\$50

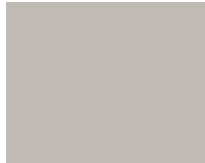

MFG Gray  
Satin Finish  
(Premium)

MFGG Graphite Gray  
Matte Finish  
(Premium)

MFS Silver  
Satin Finish  
(Premium)

MFMB Matte Black  
Matte Finish  
(Premium)

MFNA Navy  
Matte Finish  
(Premium)

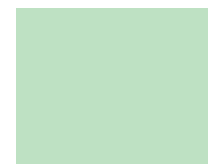
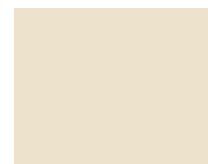

MFOL Olive  
Matte Finish  
(Premium)

MFGB Grey Beige  
Matte Finish  
(Premium)

MFSA Surfing Aquavert  
Matte Finish  
(Premium)

MFOS Oyster  
Matte Finish  
(Premium)

MFPS Pistachio  
Matte Finish  
(Premium)

MFSS Salmon Sienna  
Matte Finish  
(Premium)

## Honey Options

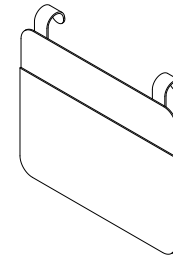

Single Sided

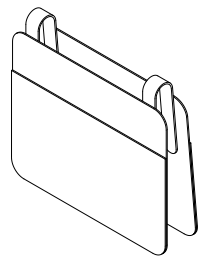

Double Sided

## Marker Board

Style Number	List Price
HDMB	\$273

## Specifications

- > Dry erase marker board, available in White Metal Finish
- > Single side use, marker boards can nest together for double sided application.
- > Marker board slides into position on the tops of the Honey panel system and can be easily repositioned.

Available: Honey



# DARRAN®

## Hanging Planter

Style Number	List Price
HHP1(Rounded Ceramic)	\$159
HHP2(Cylindrical Stone Powder)	\$276

## Specifications

- > Mounted to metal panel hook.
- > No drainage holes.
- > Metal hooks available in White or Black Standard Metal Finish. Premium finishes are available.
- > Hanging planter comes in a rounded ceramic or cylindrical stone powder.

Available: Honey

## Standard Colors (Metal)

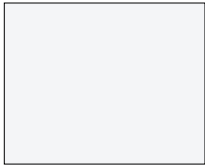

MFW White  
Satin Finish  
(Standard)

MFB Black  
Satin Finish  
(Optional - N/C)

## Premium Colors(Matte) - +\$50



MFGB Gray  
Satin Finish  
(Premium)

MFGG Graphite Gray  
Matte Finish  
(Premium)

MFS Silver  
Satin Finish  
(Premium)

MFMB Matte Black  
Matte Finish  
(Premium)

MFNA Navy  
Matte Finish  
(Premium)

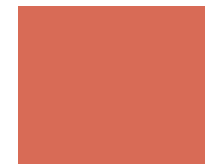

MFOL Olive  
Matte Finish  
(Premium)

MFGB Grey Beige  
Matte Finish  
(Premium)

MFSA Surfing Aquavert  
Matte Finish  
(Premium)

MFOS Oyster  
Matte Finish  
(Premium)

MFPS Pistachio  
Matte Finish  
(Premium)

MFSS Salmon Sienna  
Matte Finish  
(Premium)



## Honey Options

# DARRAN®

Round Wastebasket with Lid

Style Number                      List Price  
HTC                                      \$415

## Specifications

- > Size: 7.5" diameter x 10.7" high
- > Easy-push swing lid allows you to store in plain sight; The trash is contained and out of view.
- > Attaches to inside corner of Honey workstation configurations.
- > Trash can sits on 3/4" thick wood round disc.
- > Easy to clean. Wipe clean with a damp cloth; The durable interior can be rinsed out with mild soap and water when needed.
- > Made of durable BPA and Chlorine free shatter-resistant plastic.
- > Standard with removable lid.

Available: Honey

## Honey Options



### Step 1: Select Wastebasket Color



White/Gray



Charcoal



Black

### Step 2: Select wood finish for base

- PO01 Olive
- PO02 Aquavert
- PO03 Mushroom
- PO07 Pebble
- PO08 Vapour
- PO09 Verde

- WOW Clear Walnut
- WNO Natural Oak
- WSO Salted Oak
- WBW Henna Walnut
- WSW Smokey Walnut
- WWP Designer White

- PM01 Olive
- PM02 Aquavert
- PM03 Mushroom
- PM07 Pebble
- PM08 Vapour
- PM10 Verde

Aircharge wireless charging grommet

Style Number	List Price
 ACWG WIRELESS GROMMET	\$213

### Specifications

- > When used with GROVE Tables an additional \$350 LIST will apply for the special cutout required.
- > AirCharge offers a convenient way to charge any Qi compatible smartphone or device without the need to carry charging cables or find an available power outlet.
- > The Aircharge is powered by the latest Qi compliant IC offering reliable and efficient wireless charging in a convenient 3" grommet hub. Simply place your phone on the Aircharge and an LED will confirm pairing and begin wireless charging.
- > Recess: Efficient space conservation and quick access
- > Input: DC 5V (with included AC power adapter), DC 9V, 1.67A (with optional QC 2.0 power adapter)
- > Output: 5 watts Max. with DC 5V, 2A power adapter, 10 watts Max. with QC 2.0 power adapter
- > Qi V1.2 compliant IC
- > Charging distance: 6mm Max.

Available: All DARRAN collections





Cove power unit - non-linking

Style Number	List Price
 PD-COVE PLUG	\$600
Non-linking version	

### Specifications

- > Size 5.75"L x 2.5"W
- > (2) 15 Amp Receptacles and (2) USB charging ports
- > Surface Mount
- > 108" Cord
- > Standard Silver Finish, Available in White or Black Finish upon request
- > ETL Listed

Available: All DARRAN collections



Soba wire manager

Style Number	List Price
STARTER UNITS	
SCDW	\$218
White wire manager	
SCDB	\$218
Black wire manager	



### Specifications

- > Dimensions: 9ft x 9in x 3.15in
- > Zips up, bundles and routes loose, messy cables into a single tube
- > Routes and guides cables behind desks, TVs, and anywhere cables tend to get messy
- > Accommodates large or small cables, up to three cables at once
- > Support channels, used to route cables, include powerful adhesive backing which allows easy attachment to surfaces.

Available: All DARRAN collections



VILLA Power unit with daisylink

Style Number	List Price
STARTER UNITS	
 VIL-DCH HARDWIRED	\$975
Includes (1) Villa unit with 120" Hardwire Infeed	
 VIL-DCP PLUG	\$975
Includes (1) Villa with Plug Infeed - Includes 72" Cord and 32" Infeed Jumper for 104" total cord infeed	
ADDITIONAL LINKING UNITS	
VIL-DCL ADDITIONAL	\$950
(Includes linking Villa and Jumper cable up to 96")	

## Specifications

- > Size: Top Grommet 5.68"L X 3.39"W; Under Top 12"L x 3.13"W x 3.08"D
- > (4) Power receptacles; (2) surface and (2) undersurface, (2) 2.1A USB charging ports and (1) Knockout for RJ45 Data Port
- > Surface Mount
- > Daisy Chain - Hardwire Max (10) Units, Plug/Corded Max (5) Units
- > Standard Silver Finish, Black Finish available upon request
- > UL or ETL Certified

Available: All DARRAN collections, excludes grove

RJ45 Knockout	
RJ45 (1)	\$55



Tully power unit

Style Number

List Price



PD-TULLY

\$349

## Specifications

- > 5.5" W x 3.2" H x 1.8" D
- > Finish: Smooth molded plastic integrated within a single piece cover
- > Mounts to the edge of your work surface, with no table cut outs or installation required.
- > (2) Power receptacles, (2) USB 2.1 Amp ports
- > 72" Cord (10' cord available, contact customer service).
- > Standard in White. Available in gray, black, neon red, harvest pumpkin, light green, daisy blue.
- > UL310, Class 2, FCC Part 15A approved
- > Clamp accessory accommodates table thickness from .75"-1.5"

Available: Honey, EdgeWorks, NSS Open,, Thinking Quietly.

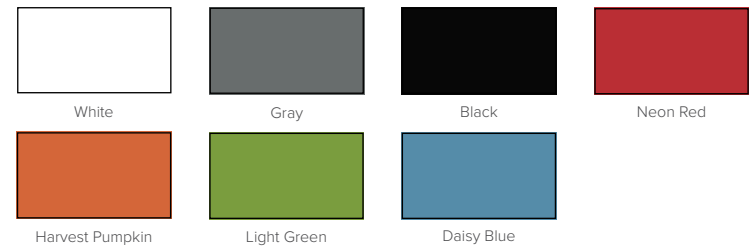

Tully Inline Power unit

Style Number

List Price



PD-Tully-IN72 72" Cord  
 PD-Tully-IN120 120" Cord

\$660  
 \$682

Specifications

PD TULLY Worksurface Unit

- > 5.5" W x 3.2" H x 1.81" D
- > Finish: Smooth molded plastic integrated within a single piece cover
- > Mounts to the edge of your work surface, with no table cut outs or installation required.
- > (2) Power receptacles, (2) USB 2.1 Amp ports
- > 72" and 120" Plug Cord
- > Standard in White. Available in gray, black, neon red, harvest pumpkin, light green, daisy blue.
- > UL310, Class 2, FCC Part 15A approved
- > Clamp accessory accomodates table thickness from .75"-1.5"

Tully Under Worksurface Unit

- > 11.75" x 2.5" x 2.05"
- > 4 - 15A, AC Power Outlets mounted under the worksurface
- > 24" Cord that connects to PD Tully
- > Comes with wire manager hooks to secure power cord when not in use
- > UL 962A Listed, UL 1310 Recognized, Meets UL Spill Requirements, Class 2, FCC Part 15 A Approved

Available: All Collections



Power Unit Color

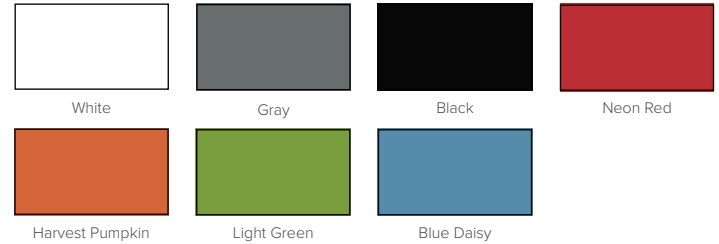

Cord Color



Keno power unit

Style Number

List Price



PD-KENO

\$213

### Specifications

- > Size 5.5"L x 2.125"W x 2.5"H
- > 2 TR AC Outlets
- > 1 4.2A USB module w/ 2 charging ports
- > 10' Power cord

Available: Honey, EdgeWorks, NSS Open, Thinking Quietly



White



Black

Nuuk single power unit with undersurface mount

Style Number

List Price



PD-NUUK1-UM

\$317

## Specifications

- > 1 AC receptacle with (1.5A) and fast-charging (2.4A) USB ports for rapid re-charging
- > 6' Power cord, available in black or white
- > Optional fabric woven cord in Graphite or Ivory - \$50
- > UL962A listed
- > UL1310 listed power supply
- > Size: 4.44"L x 4.11"x 2.33H
- > Undersurface mount



Available: On all DARRAN collections

### Step 1: Select Body Color



### Step 2: Select AC Receptacle Color

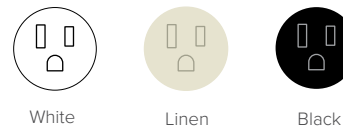

### Step 3: Select Cord Color

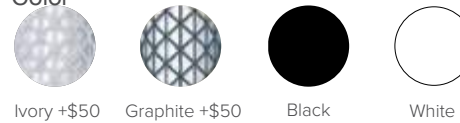

Nuuk dual power unit with undersurface mount

Style Number

List Price



PD-NUUK2-UM

\$366

## Specifications

- > 2 AC receptacle with (1.5A) and fast-charging (2.4A) USB ports for rapid re-charging
- > 6' Power cord, available in black or white
- > Optional fabric woven cord in Graphite or Ivory - \$50
- > UL962A listed
- > UL1310 listed power supply
- > Size: 6.11"L x 4.11"W x 2.33"H
- > Undersurface mount





Available: All DARRAN collections





### Step 1: Select Body Color

				
White	Black	Cayenne	Clementine	Cranberry
				
Currant	Dijon	Eggplant	Forest	Goldenrod
				
Grape	Gulf	Kiwi	Maize	Marine
				
Merlot	Ocean	Paprika	Pineapple	Porcelain
				
Pumpkin	Punch	Raisin	Silver-Sage	Silver
				
Sky	Spruce	Teal	Tranquil	

### Step 2: Select AC Receptacle Color

		
White	Linen	Black

### Step 3: Select Cord Color

			
Ivory +\$50	Graphite +\$50	Black	White



Nuuk single power unit with clamp

Style Number

List Price



PD-NUUK1-CL

\$355





## Specifications

- > 1 AC receptacle with (1.5A) and fast-charging (2.4A) USB ports for rapid re-charging
- > 6' Power cord, available in black or white
- > Optional fabric woven cord in Graphite or Ivory - \$50
- > UL962A listed
- > UL1310 listed power supply
- > Size: 4.44"L x 4.35"W x 3.03"H
- > Clamp mount: clamps onto surfaces of 3/4-1-1/4" thickness



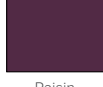

Available: On all DARRAN collections, excluding Grove





### Step 1: Select Body Color

 White	 Black	 Cayenne	 Clementine	 Cranberry
 Currant	 Dijon	 Eggplant	 Forest	 Goldenrod
 Grape	 Gulf	 Kiwi	 Maize	 Marine
 Merlot	 Ocean	 Paprika	 Pineapple	 Porcelain
 Pumpkin	 Punch	 Raisin	 Silver-Sage	 Silver
 Sky	 Spruce	 Teal	 Tranquil	

### Step 2: Select AC Receptacle Color

 White	 Linen	 Black
--	--	--

### Step 3: Select Cord Color

 Ivory +\$50	 Graphite +\$50	 Black	 White
--	---	--	--

Nuuk dual power unit with clamp

Style Number

List Price



PD-NUUK2-CL

\$409

### Specifications

- > 2 AC receptacle with (1.5A) and fast-charging (2.4A) USB ports for rapid re-charging
- > 6' Power cord, available in black or white
- > Optional fabric woven cord in Graphite or Ivory - \$50
- > UL962A listed
- > UL1310 listed power supply
- > Size: 6.11"L x 4.35"W x 2.33"H
- > Clamp mount: clamps onto surfaces of 3/4-1 1/4" thickness



Available: All DARRAN collections, excluding Grove

#### Step 1: Select Body Color

White	Black	Cayenne	Clementine	Cranberry
Currant	Dijon	Eggplant	Forest	Goldenrod
Grape	Gulf	Kiwi	Maize	Marine
Merlot	Ocean	Paprika	Pineapple	Porcelain
Pumpkin	Punch	Raisin	Silver-Sage	Silver
Sky	Spruce	Teal	Tranquil	

#### Step 2: Select AC Receptacle Color

White	Linen	Black

#### Step 3: Select Cord Color

Ivory +\$50	Graphite +\$50	Black	White