



Bota Price List

Effective April 1, 2024

Designed by Keith Melbourne

Date	Page	Modification	Description
04.05.24	Updated Pricing		

Statement of Line
Bota seating & fabric program.....1
Seating Specification4
Rear Table Specification5
Grommet Placement7
Finishes8
Seating.....9
Ottoman54
Booths.....57
Freestanding Table.....59
Coat Stand.....62
Power and Data63

Statement of Line

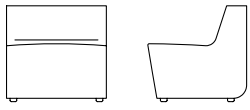

Page 9
Single Seat
Low Back

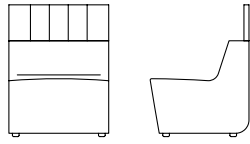

Page 10
Single Seat With Privacy Screen
Low Back - 10.5" Privacy Screen

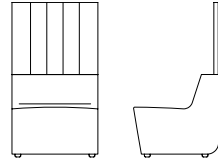

Page 11
Single Seat With Privacy Screen
Low Back - 24.75" Privacy Screen

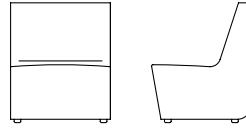

Page 12
Single Seat
High Back

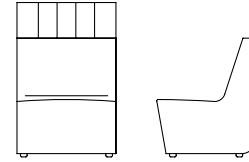

Page 13
Single Seat With Privacy Screen
High Back - 10.5" Privacy Screen

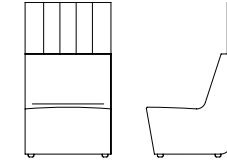

Page 14
Single Seat With Privacy Screen
High Back - 17.5" Privacy Screen

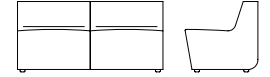

Page 15
Double Seat
Low Back

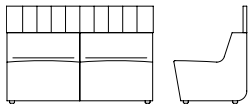

Page 16
Double Seat With Privacy Screen
Low Back - 10.5" Privacy Screen

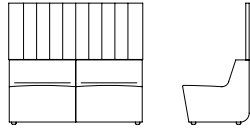

Page 17
Double Seat With Privacy Screen
Low Back - 24.75" Privacy Screen

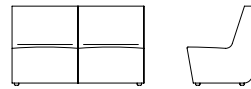

Page 18
Double Seat
High Back

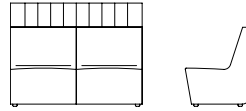

Page 19
Double Seat With Privacy Screen
High Back - 10.5" Privacy Screen

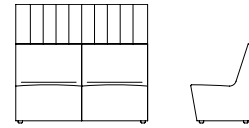

Page 20
Double Seat With Privacy Screen
High Back - 17.5" Privacy Screen

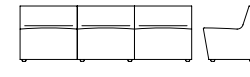

Page 21
Triple Seat
Low Back

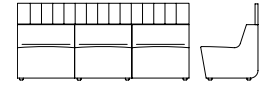

Page 22
Triple Seat With Privacy Screen
Low Back - 10.5" Privacy Screen

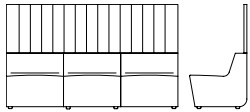

Page 23
Triple Seat With Privacy Screen
Low Back - 24.75" Privacy Screen

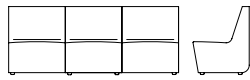

Page 24
Triple Seat
High Back

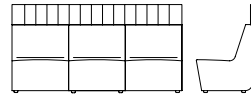

Page 25
Triple Seat With Privacy Screen
High Back - 10.5" Privacy Screen

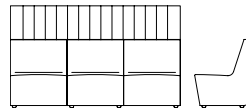

Page 26
Triple Seat With Privacy Screen
High Back - 17.5" Privacy Screen

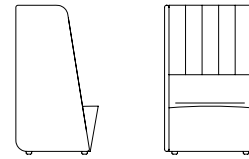

Page 27
Shell - Single Seat
Low Back - Side Screens &
Privacy Screen

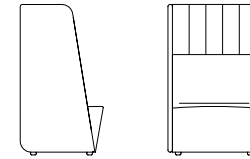

Page 28
Shell - Single Seat
High Back - Side Screens &
Privacy Screen

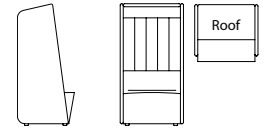

Page 29
Shell - Single Seat
Low Back - Side Screens, Privacy
Screen & Roof

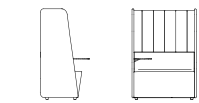

Page 30
Work Shell
Single - Seat

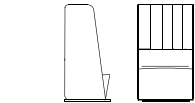

Page 31
Shell - Single Seat
Low Back - Swivel Base

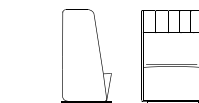

Page 32
Shell - Single Seat
High Back - Swivel Base

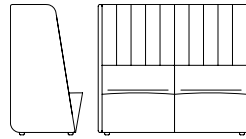

Page 33
Shell - Double Seat
Low Back - Side Screens &
Privacy Screen

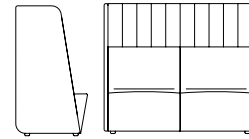

Page 34
Shell - Double Seat
High Back - Side Screens &
Privacy Screen

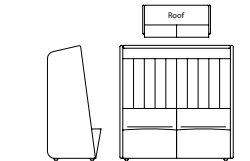

Page 35
Shell - Double Seat
Low Back - Side Screens, Privacy
Screen & Roof

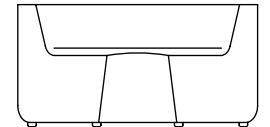

Page 36
90 Deg. Circlet - Single Seat
Low Back
90 Degree Back Inside Radius
- Low Back

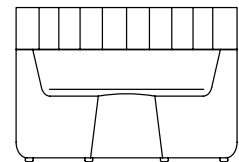

Page 37
90 Deg. Circlet - Single Seat Low
Back With Privacy Screen
90 Degree Back Inside Radius -
Low Back - 10.5" Privacy Screen

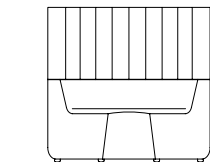

Page 38
90 Deg. Circlet - Single Seat Low
Back With Privacy Screen
90 Degree Back Inside Radius -
Low Back - 24.75" Privacy Screen

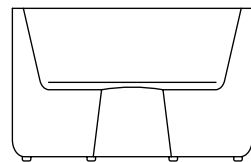

Page 39
90 Deg. Circlet - Single Seat
High Back
90 Degree Back Inside Radius
- High Back

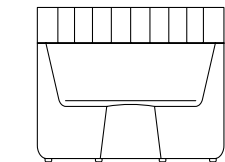

Page 40
90 Deg. Circlet - Single Seat High
Back With Privacy Screen
90 Degree Back Inside Radius -
High Back - 10.5" Privacy Screen

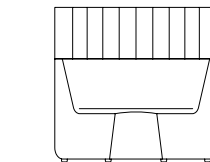

Page 41
90 Deg. Circlet - Single Seat High
Back With Privacy Screen
90 Degree Back Inside Radius -
High Back - 17.5" Privacy Screen

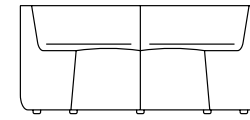

Page 42
60 Deg. Circlet - Double Seat
Low Back
60 Degree Back Inside Radius
- Low Back

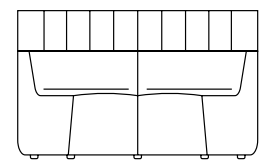

Page 43
60 Deg. Circlet - Double Seat
Low Back With Privacy Screen
60 Degree Back Inside Radius -
Low Back - 10.5" Privacy Screen

Statement of Line

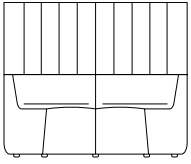

Page 44
60 Deg. Circllet - Double Seat
Low Back With Privacy Screen
60 Degree Back Inside Radius -
Low Back - 24.75" Privacy Screen

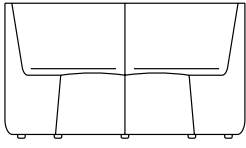

Page 45
60 Deg. Circllet - Double Seat
High Back
60 Degree Back Inside Radius
- High Back

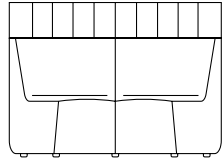

Page 46
60 Deg. Circllet - Double Seat
High Back With Privacy Screen
60 Degree Back Inside Radius -
High Back - 10.5" Privacy Screen

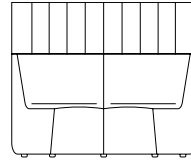

Page 47
60 Deg. Circllet - Double Seat
High Back With Privacy Screen
60 Degree Back Inside Radius -
High Back - 17.5" Privacy Screen

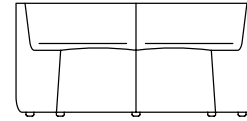

Page 48
45 Deg. Circllet - Double Seat
Low Back
45 Degree Back Inside Radius
- Low Back

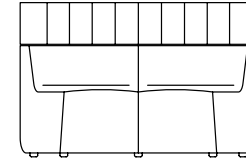

Page 49
45 Deg. Circllet - Double Seat
Low Back With Privacy Screen
45 Degree Back Inside Radius -
Low Back - 10.5" Privacy Screen

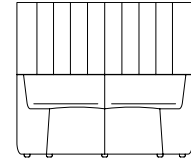

Page 50
45 Deg. Circllet - Double Seat
Low Back With Privacy Screen
45 Degree Back Inside Radius -
Low Back - 24.75" Privacy Screen

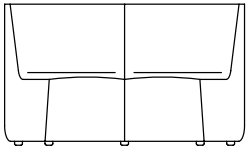

Page 51
45 Deg. Circllet - Double Seat
High Back
45 Degree Back Inside Radius
- High Back

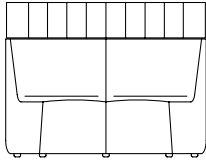

Page 52
45 Deg. Circllet - Double Seat
High Back With Privacy Screen
45 Degree Back Inside Radius -
High Back - 10.5" Privacy Screen

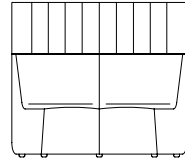

Page 53
45 Deg. Circllet - Double Seat
High Back With Privacy Screen
45 Degree Back Inside Radius -
High Back - 17.5" Privacy Screen



Page 54
Ottoman
19" Ottoman

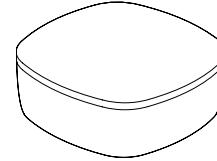

Page 55
Ottoman
48" Ottoman

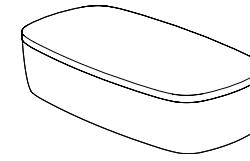

Page 56
Ottoman
70" Ottoman

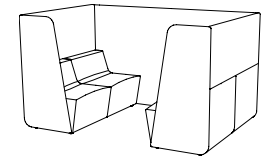

Page 57
Booth
4 Person Meeting Booth

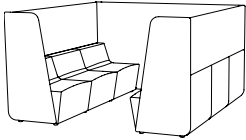

Page 58
Booth
6 Person Meeting Booth



Page 59
Booth Table
4 Person Meeting Booth Table



Page 60
Booth Table
6 Person Meeting Booth Table



Page 61
Freestanding Table
Freestanding Table



Page 62
Coat Stand
Wire Coat Stand

Seating & Fabric Leather Program

DARRAN has partnered with some of the most prestigious fabric suppliers of the office furniture industry to bring you quality fabrics that are engaging designs, environmentally friendly and durable for years to come. The majority of fabrics we have graded-in are in heavy supply making it most likely available on our Quickship however, we cannot guarantee stock. If you do not see the fabric you wish to include in a project, please contact Customer Service to see if this pattern can be graded in at 800.334.7891.

Fabrics & Leathers

Please visit our Seating Fabrics page at darran.com/textilesleather

Camira
www.camirafabrics.com
800.334.789

Wollsdorf
www.wollsdorf.com
336.884.5005

CFStinson
www.cfstinson.com
800.841.6279

Green Hides
www.greenhides.com
336.315.9720

DesignTex
www.cfstinson.com
800.841.6279
www.designtex.com
800.797.4949

Kvadrat
www.kvadrat.fabrics.com
+45 8953 1866

Maharam
www.maharam.com
800.645.3943

Momentum Textiles
www.momentumtextiles.com
800.366.6839

Ultrafabrics
www.ultrafabricsinc.com
800.334.7891

Application instructions must be specified on the purchase order or COM / COL submission form. In the absence of application instructions, DARRAN will apply materials accordingly.

CAL117

All DARRAN seating products conform to California Technical Bulletin 117 as a minimum

standard.

CAL133

To meet the California Technical Bulletin 133 flammability regulation, a combination of proper materials must be used to pass, as it tests the fire resistance of a finished product. Flame resistant fabric, a fire blocker material and special foam must be used to pass CAL133 fire codes.

Testing is available for all seating products with the following fees and considerations:

- If laboratory certification is not required, any style can be manufactured to comply with California Technical Bulletin 133 for \$75 list per yard required. (Customer's Own Materials must factor in additional yardage requirements based on repeat.)
- The purchase order must clearly indicate the requirement of California Technical Bulletin 133
- If laboratory California Technical Bulletin 133 certification is required, the cost of testing a chair is \$820 NET, plus the cost of the chair and covering material.
- An additional lead time of 4 to 6 weeks is required for testing for CAL133.
- Once testing is completed, we will provide a certification letter specific to the sample tested for CAL133.
- DARRAN's manufacturing procedures for California TB 133 compliance are based on the testing of representative style with specific fabrics. Please contact Customer Service for an updated list of tested models.
- A copy of test certification is available upon request.

Combination Fabrics

DARRAN is pleased to offer customers the design freedom of combination fabrics. When using fabric, vinyl or leather combinations, pricing will be as follows:

- When combining two materials of the same grade, pricing will be specified grade + 5%.
- If combining two materials of different grades or leather/ fabric combination, use the highest grade/price + 5%.
- If using COM or COL, pricing will be COM or COL + 5%. If both COM + COL are used in combination, use COL + 5%

COM/COL Ordering Instructions

Please complete the COM Submission Form prior to ordering the fabric from the supplier. All COM fabrics must be approved prior to order submission. Please refer to our website or contact DARRAN Seating Customer Service for an updated list of preapproved COM fabrics. Application instructions must be specified on the purchase order or COM/COL approval form. In the absence of application instructions, DARRAN will apply materials in the best manner and cannot be held responsible for tailoring or application objections after upholstery. COM orders will be scheduled for production after receipt of the material. Packages must be clearly marked and the fabric must be first quality, continuous yardage.

COM/COL yardage requirements

The yardage requirements stated in this price list for each style are calculated using 54" wide, non-directional fabrics. For fabrics with a different width or for patterns with repeats, please refer to the below chart to calculate the additional percent of fabric required:

Fabric Width	Plain Fabric	2"- 14" Repeat	15"- 19"Repeat	20"- 27"Repeat	28"- 36" Repeat
54"	0	15%	20%	25%	30%
53"	6%	19%	24%	28%	36%
52"	13%	23%	28%	33%	38%
51"	19%	26%	31%	36%	41%
50"	25%	30%	35%	40%	45%
49"	30%	35%	40%	45%	50%
48"	35%	40%	45%	50%	55%
47"	45%	50%	55%	58%	65%

DARRAN®

Bota Seating Fabric & Leather Program

NOTE: Prior To Completion Of This Form, Please Refer To Our Graded In Materials Program For Preapproved Fabrics/Leathers.

COM/COL Approval

DARRAN Furniture Industries
2402 Shore Street, High Point, NC 27263
ATTN: Seating Division / COM/COL Approval
TAG: DARRAN Quote Number

Shipping Approved COM/COL Materials

DARRAN Furniture Industries
2402 Shore Street, High Point, NC 27263
ATTN: Seating Division / COM/COL Approval
TAG: DARRAN Quote Number

Please complete this form, attach a 6"x 6" sample and mail to the COM/COL APPROVAL address shown above.
This form can also be downloaded from our website at www.darran.com/leathers OR www.darran.com/fabrics

Quote # _____

Dealer's Name _____

Contact _____

Address _____

Telephone _____

Email _____

Chair Stlye _____

Manufacturer _____

Pattern Name _____

Pattern Color _____

Content _____

Repeat _____

Please specify any special requirements and check the application above.

ATTACH 6" X 6" FABRIC/LEATHER SAMPLE HERE

NOTE
Actual Fabric/Leather samples needed instead of digital images. If digital images are sent in lieu of samples, DARRAN will only verify the pattern and will not take responsibility for color variances that cannot be verified due to printing limitations.

In the absence of application instructions, DARRAN will apply the material in the best manner and cannot be held responsible for tailoring or application objections after upholstering.

Unless otherwise instructed on the purchase order, excess COM materials will be recycled at the discretion of DARRAN after six months of the original product ship date.

The COM approval solely pertains to the application of the fabric onto the specified DARRAN seating product. DARRAN's approval or acceptance does not constitute any responsibility or warranty to the overall appearance, durability, flammability, defects, dye lot variations or colorfastness of the COM. It is the customer's responsibility to ensure the COM meets CAL 117 compliance and are first quality continuous goods.

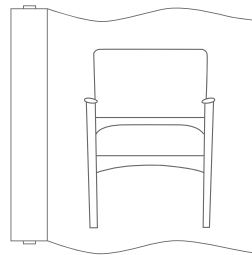

Railroad

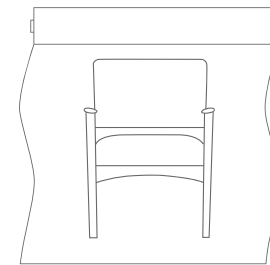

Setup

Joints are securely fastened with mortise and tenon joinery as well as well as corner block construction to ensure long-term use.

Ability to incorporate variety of options

Tablet mounts and combination fabrics.

Complete domestic production

Complete domestic production from frame through upholstery, controlled by one manufacturing facility. Less stress / damage to chair parts normally caused by overseas transit, providing consistent, reliable quality standards as a quick response to shorter lead times.

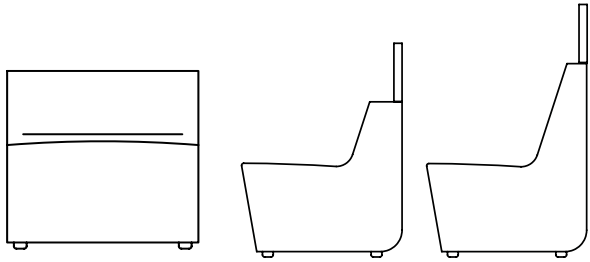

Offered in Low or high back. Seats and back are webbed to enhance comfort, sustainability and endurance. Frame constructed CNC cut engineered wood to maximize the strength, precise measurements and overall longevity. Soy-based, high resilient polyurethane foam consisting of multiple densities in seat and backs, achieving maximum comfort and durability.

Optional tablet or rear tables offered in 1/2" compact laminate featuring a black core. Tablets are center mounted between 2 seats. Horizontal back frame provides easy ganging capabilities for expansion and flexibility in various settings.

Rear tables are at 28.5" high on low back units, and 35.5" high on high back units.

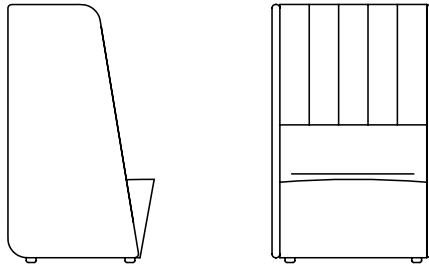

Side Screens and Back Privacy screens create private areas to focus or define a team.

Privacy Screens are available in 10.5", 17.5" & 24.75"

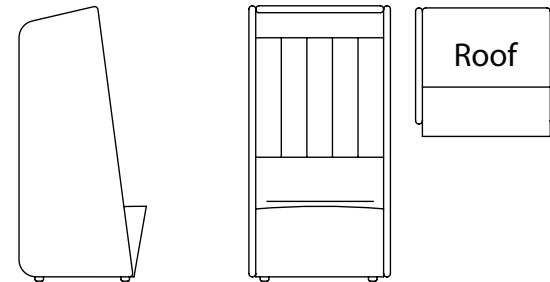

The Bota Roof allows for sound to be absorbed creating a focus nook.

Available in a single or double seat module.

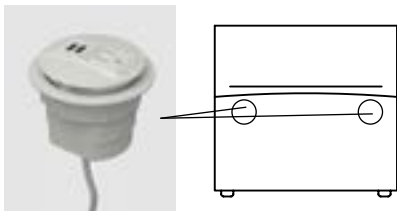

Specify power

Node features 1 power & 1 USB duplex, ideal for charging tablets and other USB-friendly electronics. Node is UL approved.

Specify location, see page 64 for additional details.

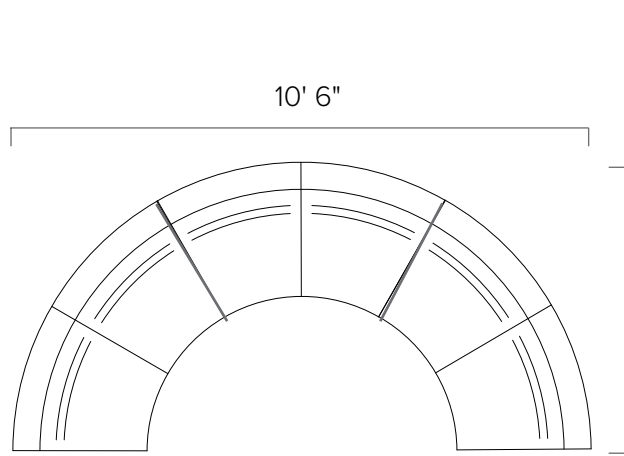

60 Degree
3 Units shown above
per half circle

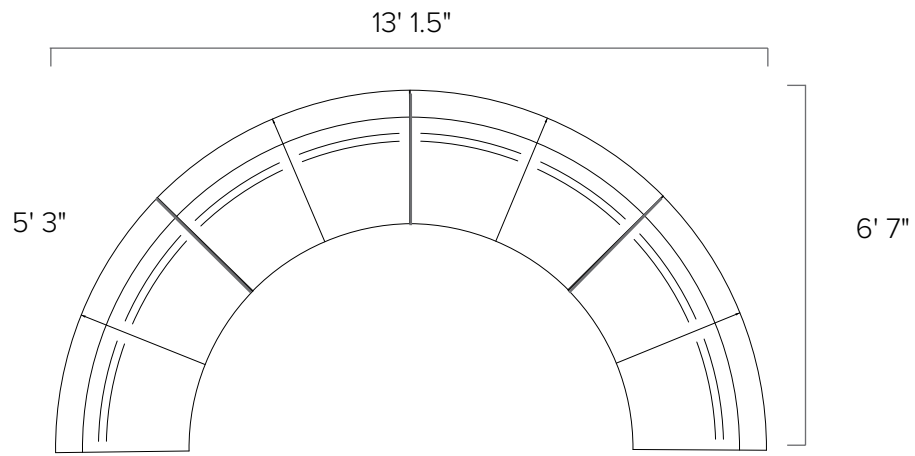

45 Degree
4 Units shown above
per half circle

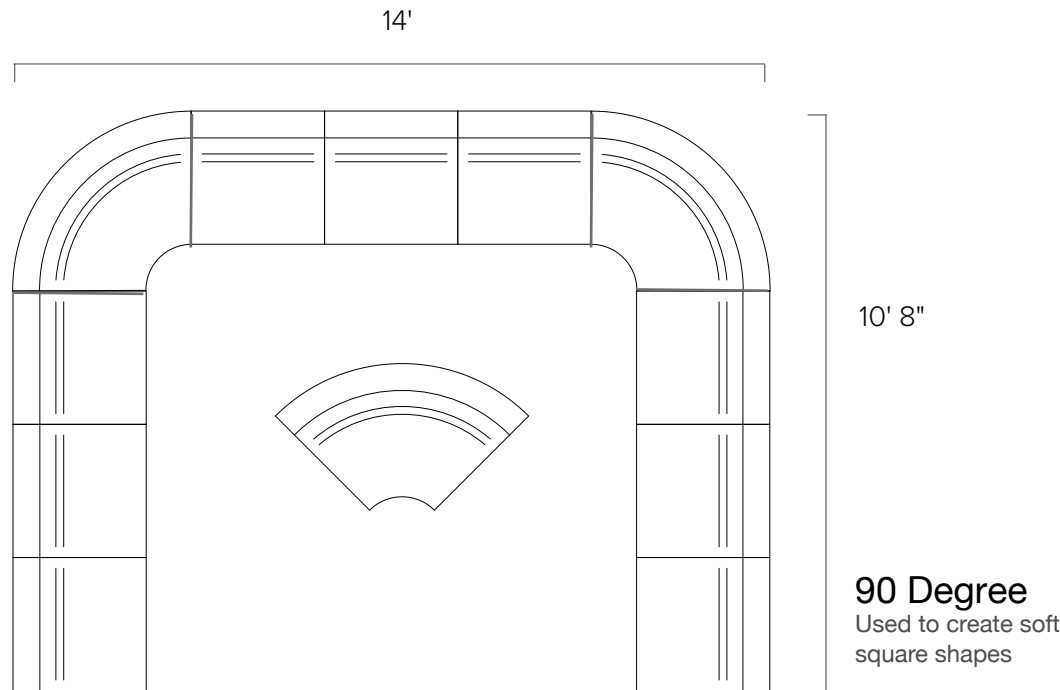

90 Degree
Used to create soft
square shapes

2' 5.5"W



1' 3"D

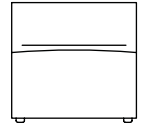

Single Seat Unit

4' 11"W



1' 3"D



Double Seat Unit

7' 4.5"W



1' 3"D

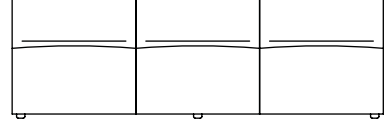

Triple Seat Unit

6' 9.5"W



1' 3"D

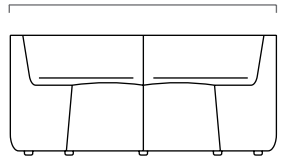

60 Degree Unit

6' 2"W

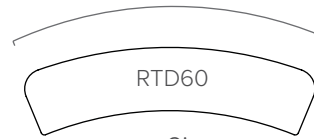

1' 3"D

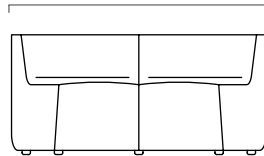

45 Degree Unit

6' 9"W

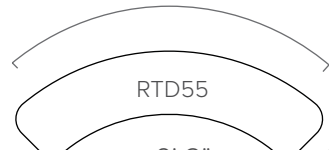

1' 3"D

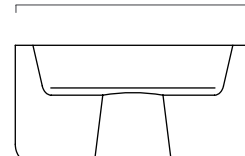

90 Degree Unit

Booth Wall Exterior

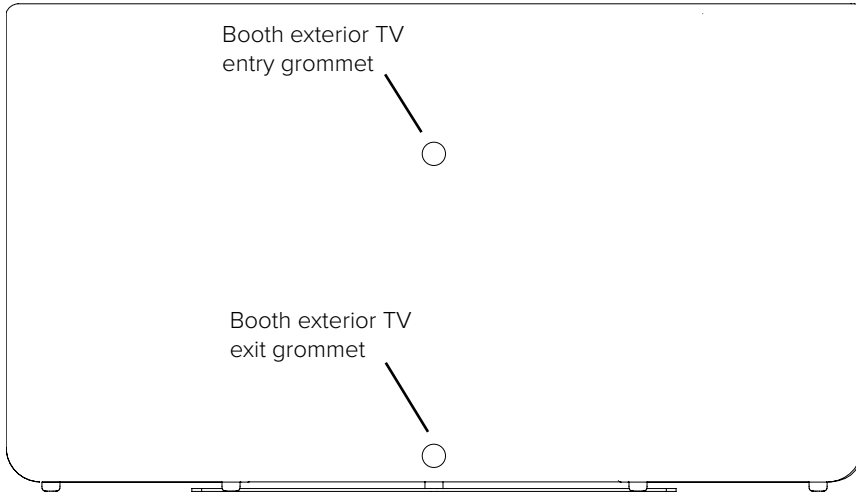

Booth Wall Interior

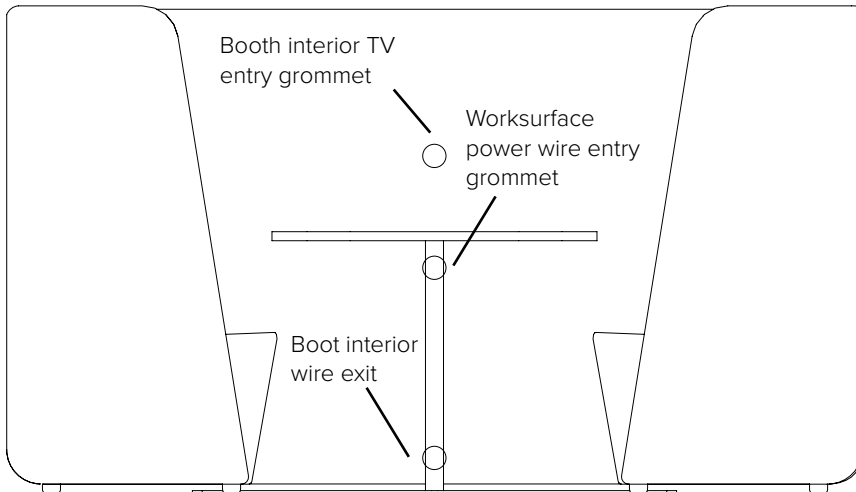

Bota Booth Grommet Placement

Bota booth walls have an integrated wire management channel built into the frame. Grommets are available in TM71 black or TM70 white. The channel runs through the center of the wall, allowing cables to enter and exit. Specify interior or exterior location.

veneERS



WAM Alabaster Maple



WAF Narvik Ash



WCM Clear Maple



WLF Lofty Oak



WFF Fawn Cypress



WNF Natural Oak



WEF Neo Walnut



WWW Weathered Walnut



WOW Clear Walnut



WGW Gunstock Walnut



TSTV Studio Teak



TSLV Skyline Walnut



WMO Mocha Oak



GEW Executive Walnut



WNW Natural Walnut



WSW Smokey Walnut



WBW Henna Walnut



WEC Ebony

HIGH PRESSURE LAMINATES

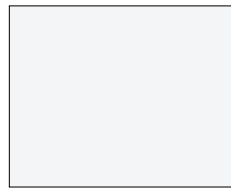

GWL Designer White

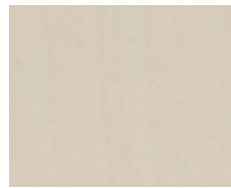

GAM Alabaster Maple



GNA Narvik Ash



GCM Clear Maple



LW02 Fawn Cypress



LW01 Neo Walnut



GSTV Studio Teak



GSLV Skyline Walnut



GNW Natural Walnut

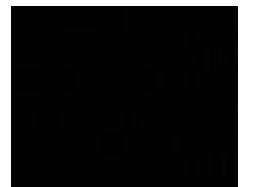

GEC Ebony

Finish

Welltech Finish delivers a superior furniture coating with exceptional performance that can withstand stringent cleaning agents and possesses unparalleled durability, allowing DARRAN to provide lasting, sustainable products to our customers.



TFL LAMINATE



MWL Designer White



MNA Narvik Ash



MWW Weathered Walnut



MTW Studio Teak



MGW Gunstock Walnut



MSW Skyline Walnut



MEC Ebony Cherry

FENIX LAMINATES ADD 20% to HPL Pricing



LFBK Bianco Kos
+20% to "G" Sku

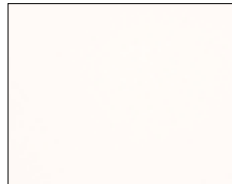

LFBM Bianco Male
+20% to "G" Sku



LFB A Beige Arizona
+20% to "G" Sku



LFB L Beige Luxor
+20% to "G" Sku



LFG E Gringo Efeso
+20% to "G" Sku



LFC V Verde Comodoro
+20% to "G" Sku



LFC W Castoro Ottawa
+20% to "G" Sku

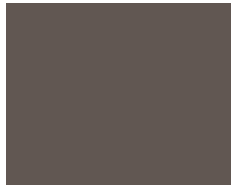

LFG L Gringo Londra
+20% to "G" Sku

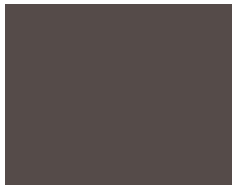

LFC O Cacao Orinoco
+20% to "G" Sku

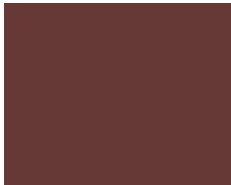

LFR J Roosoo Jaipur
+20% to "G" Sku



LFG B Gringo Bromo
+20% to "G" Sku



LFB F Blue Fe
+20% to "G" Skus

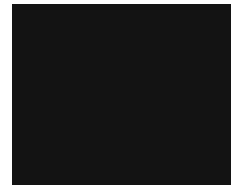

LFC N Nero Ingo
+20% to "G" Sku

The benefits of FENIX® surface material:

- Soft to the touch
- Extremely matte
- Resists fingerprints
- Highly resistant to scratches, abrasion, acid-based solvents and household cleaners

COMPACT FENIX LAMINATES *ONLY AVAILABLE ON CERTAIN ITEMS. REFERENCE PRICE LIST PAGES



LCBK Bianco Kos

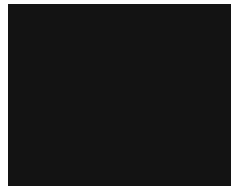

LCNI Nero Ingo



LCGE Gringo Efesto

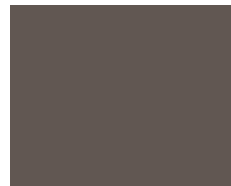

LCGL Gringo Londra

POWDERCOATS

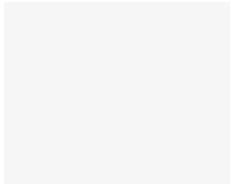

MFW White



MFCH Chrome

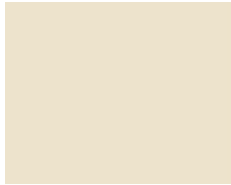

MFOS Oyster



MFG Grey



MFGW Gray White



MFS Silver



MFGB Grey Beige



MFGM Gold



MFSB Satin Bronze



MFGG Graphite Gray



MFNA Navy



MFMB Matte Black



MFDB Dark Bronze

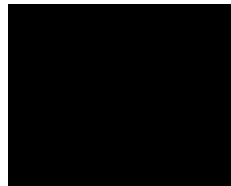

MFB Black

Bota

Single Seat
Low Back

[Click here to view statement of line](#)

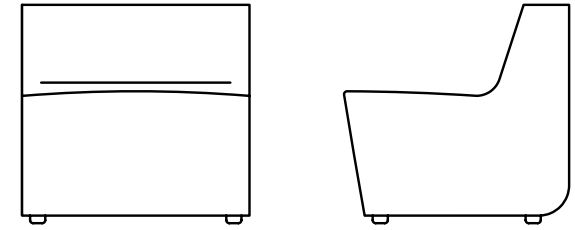

1 Model BOT0160SLC01

w" x d" x h"
29.5 x 29.25 x 28.5
Arm Height -
Seat Height 17.5
Inside Seat Depth 17
Inside Seat Width 29.5

COM	COL	1	2	3	4	5	6	7	8	9	10	11/L1	12	13/L2
2073	2128	2183	2238	2293	2348	2403	2458	2513	2568	2623	2678	2733	2788	2898

Upholstery Requirements
Fabric yds: 3.5 Leather Sq. Ft.: 63
Carton Weight: 50

2 Select Finish

[Click to view finishes](#)

NA

3 Combination Fabrics

[Click to view finishes](#)

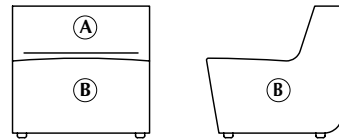

DARRAN is pleased to offer customers the design freedom of combination fabrics. When using fabric, vinyl or leather combinations, pricing/yardage requirements will be as follows:

A Inside Back & Seat 1 yd
B Lounge Exterior 3 yds

Top View

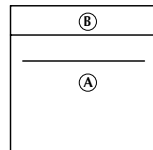

- When combining two materials of the same grade, pricing will be specified grade + 5%
- If combining two materials of different grades or leather/fabric combination, use the highest grade/price + 5%
- If using COM or COL, pricing will be COM or COL + 5%.
- If both COM + COL are used in combination, use COL + 5%.

Node Power Placement Option

Table Power

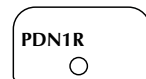

Seat Power

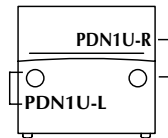

Product Features

- Horizontal back provides easy ganging capabilities.
- Utilizes elastic webbing suspension that conforms to individual's lumbar curvatures for adaptive support.
- All units are standard with 1" adjustable glides that allow for leveling

Options

Ganging Device

- GDEV-L: Left Facing Ganging Device - \$20
- GDEV-R: Right Facing Ganging Device - \$20
- GDEV-C: Center Ganging Device - \$40

Power

- PDN1U-L: Node in Left Facing Seat Front; 1 Power/1 USB Charger - \$355
- PDN1U-R: Node in Right Facing Seat Front; 1 Power/1 USB Charger - \$355
- PDN1U-B: Node in Both Left and Right Facing Seat Front; 1 Power/1 USB Charger per pod - \$709
- PDN1R- Node in Rear Mount Table Top; 1 Power/1 USB Charger - \$409
- Standard in White (Available in Silver and Black)

1/2" Compact Matte Laminate Rear Table

- Matte Laminate RTD29: Rear Work Table - \$633,
- Rear table available on units that gang providing stability - Rear table is mounted at 28.5"

Premium Finish Option (Standard White)

- Specify rear table bracket Metal Finish color - \$100 per unit
- MFS: Silver, MFB: Black

Bota

Single Seat With Privacy Screen
 Low Back - 10.5" Privacy Screen

[Click here to view statement of line](#)

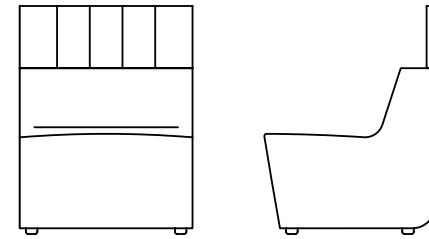

1 Model BOT0160SLC11

w" x d" x h"
 29.5 x 29.25 x 39
 Arm Height -
 Seat Height 17.5
 Inside Seat Depth 17
 Inside Seat Width 29.5

COM	COL	1	2	3	4	5	6	7	8	9	10	11/L1	12	13/L2
2801	2883	2965	3047	3129	3211	3293	3375	3457	3539	3621	3703	3785	3867	4031

Upholstery Requirements
 Fabric yds: 4.5 Leather Sq. Ft.: 81
 Carton Weight: 55

2 Select Finish

[Click to view finishes](#)

NA

3 Combination Fabrics

[Click to view finishes](#)

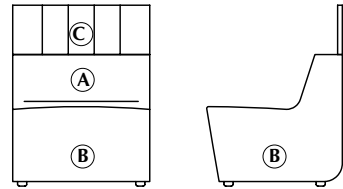

DARRAN is pleased to offer customers the design freedom of combination fabrics. When using fabric, vinyl or leather combinations, pricing/yardage requirements will be as follows:

- A Inside Back & Seat 1 yd
- B Lounge Exterior 3 yds
- C Privacy Screen 1 yd

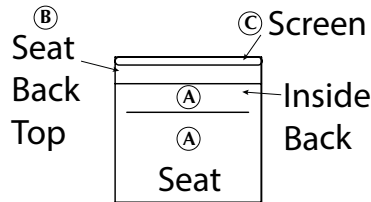

- When combining two materials of the same grade, pricing will be specified grade + 5%
- If combining two materials of different grades or leather/fabric combination, use the highest grade/price + 5%
- If using COM or COL, pricing will be COM or COL + 5%.
- If both COM + COL are used in combination, use COL + 5%.

Node Power Placement Option

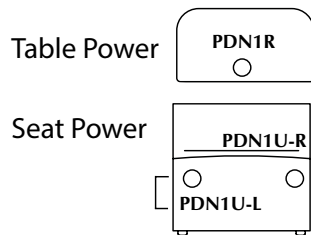

Product Features

- Horizontal back provides easy ganging capabilities.
- Utilizes elastic webbing suspension that conforms to individual's lumbar curvatures for adaptive support.
- Upholstered Privacy Screen
- Upholstered screens can be specified in contrasting fabrics, vinyl, or leathers.
- All units are standard with 1" adjustable glides that allow for leveling

Options

Ganging Device

- GDEV-L: Left Facing Ganging Device - \$20
- GDEV-R: Right Facing Ganging Device - \$20
- GDEV-C: Center Ganging Device - \$40

Power

- PDN1U-L: Node in Left Facing Seat Front; 1 Power/1 USB Charger - \$355
- PDN1U-R: Node in Right Facing Seat Front; 1 Power/1 USB Charger - \$355
- PDN1U-B: Node in Both Left and Right Facing Seat Front; 1 Power/1 USB Charger per pod - \$709
- PDN1R- Node in Rear Mount Table Top; 1 Power/1 USB Charger - \$409
- Standard in White (Available in Silver and Black)
- 1/2" Compact Matte Laminate Rear Table**
- Matte Laminate RTD29: Rear Work Table - \$633

- Rear table available on units that gang providing stability
- Rear table is mounted at 28.5"

Premium Finish Option (Standard White)

- Specify rear table bracket Metal Finish color - \$100 per unit
- MFS: Silver, MFB: Black

Bota

Single Seat With Privacy Screen
 Low Back - 24.75" Privacy Screen

[Click here to view statement of line](#)

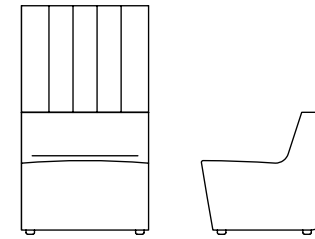

1 Model BOT0160SLC21

w" x d" x h"
 29.5 x 29.25 x 53.25
 Arm Height -
 Seat Height 17.5
 Inside Seat Depth 17
 Inside Seat Width 29.5

COM	COL	1	2	3	4	5	6	7	8	9	10	11/L1	12	13/L2
3102	3193	3284	3375	3466	3557	3648	3739	3830	3921	4012	4103	4194	4285	4467

Upholstery Requirements
 Fabric yds: 5 Leather Sq. Ft.: 90
 Carton Weight: 65

2 Select Finish

[Click to view finishes](#)

NA

3 Combination Fabrics

[Click to view finishes](#)

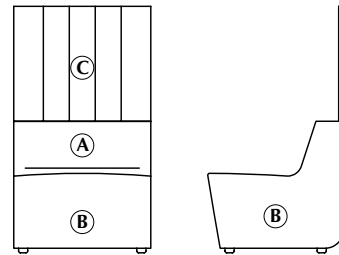

DARRAN is pleased to offer customers the design freedom of combination fabrics. When using fabric, vinyl or leather combinations, pricing/yardage requirements will be as follows:

A Inside Back & Seat 1 yd
 B Lounge Exterior 3 yds
 C Privacy Screen 1.5 yds

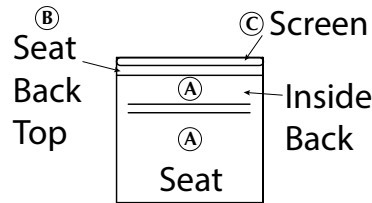

- When combining two materials of the same grade, pricing will be specified grade + 5%
- If combining two materials of different grades or leather/fabric combination, use the highest grade/price + 5%
- If using COM or COL, pricing will be COM or COL + 5%.
- If both COM + COL are used in combination, use COL + 5%.

Node Power Placement Option

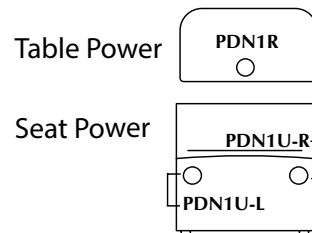

Product Features

- Horizontal back provides easy ganging capabilities.
- Utilizes elastic webbing suspension that conforms to individual's lumbar curvatures for adaptive support.
- Upholstered Privacy Screen
- Upholstered screens can be specified in contrasting fabrics, vinyl, or leathers.
- All units are standard with 1" adjustable glides that allow for leveling

Options

Ganging Device

- GDEV-L: Left Facing Ganging Device - \$20
- GDEV-R: Right Facing Ganging Device - \$20
- GDEV-C: Center Ganging Device - \$40

Power

- PDN1U-L: Node in Left Facing Seat Front; 1 Power/1 USB Charger - \$355
- PDN1U-R: Node in Right Facing Seat Front; 1 Power/1 USB Charger - \$355
- PDN1U-B: Node in Both Left and Right Facing Seat Front; 1 Power/1 USB Charger per pod - \$709
- PDN1R- Node in Rear Mount Table Top; 1 Power/1 USB Charger - \$409
- Standard in White (Available in Silver and Black)

1/2" Compact Matte Laminate Rear Table

- Matte Laminate RTD29: Rear Work Table - \$633

- Rear table available on units that gang providing stability
- Rear table is mounted at 28.5"

Premium Finish Option (Standard White)

- Specify rear table bracket Metal Finish color - \$100 per unit
- MFS: Silver, MFB: Black

Bota

Single Seat
High Back

[Click here to view statement of line](#)

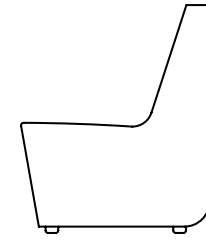
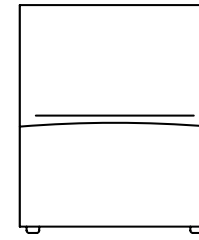

1 Model BOT0160SHC01

w" x d" x h"
29.5 x 29.25 x 35.5
Arm Height -
Seat Height 17.5
Inside Seat Depth 17
Inside Seat Width 29.5

COM	COL	1	2	3	4	5	6	7	8	9	10	11/L1	12	13/L2
2293	2366	2439	2512	2585	2658	2731	2804	2877	2950	3023	3096	3169	3242	3388

Upholstery Requirements
Fabric yds: 4 Leather Sq. Ft.: 72
Carton Weight: 50

2 Select Finish

[Click to view finishes](#)

NA

3 Combination Fabrics

[Click to view finishes](#)

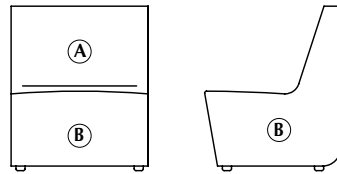

DARRAN is pleased to offer customers the design freedom of combination fabrics. When using fabric, vinyl or leather combinations, pricing/yardage requirements will be as follows:

A Inside Back & Seat 1.5 yds
B Lounge Exterior 3 yds

Top View

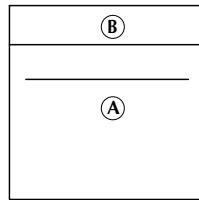

- When combining two materials of the same grade, pricing will be specified grade + 5%
- If combining two materials of different grades or leather/fabric combination, use the highest grade/price + 5%
- If using COM or COL, pricing will be COM or COL + 5%.
- If both COM + COL are used in combination, use COL + 5%.

Node Power Placement Option

Table Power Seat Power

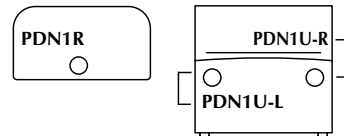

Product Features

- Horizontal back provides easy ganging capabilities.
- Utilizes elastic webbing suspension that conforms to individual's lumbar curvatures for adaptive support.
- All units are standard with 1" adjustable glides that allow for leveling

Options

Ganging Device

- GDEV-L: Left Facing Ganging Device - \$20
- GDEV-R: Right Facing Ganging Device - \$20
- GDEV-C: Center Ganging Device - \$40

Power

- PDN1U-L: Node in Left Facing Seat Front; 1 Power/1 USB Charger - \$355
- PDN1U-R: Node in Right Facing Seat Front; 1 Power/1 USB Charger - \$355
- PDN1U-B: Node in Both Left and Right Facing Seat Front; 1 Power/1 USB Charger per pod - \$709
- PDN1R- Node in Rear Mount Table Top; 1 Power/1 USB Charger - \$409
- Standard in White (Available in Silver and Black)

1/2" Compact Matte Laminate Rear Table

- Matte Laminate RTD29: Rear Work Table - \$633

- Rear table available on units that gang providing stability
- Rear table is mounted at 35.5"

Premium Finish Option (Standard White)

- Specify rear table bracket Metal Finish color - \$100 per unit
- MFS: Silver, MFB: Black

Bota

Single Seat With Privacy Screen
High Back - 10.5" Privacy Screen

[Click here to view statement of line](#)

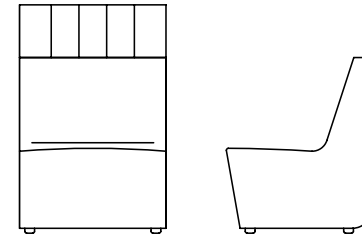

1 Model BOT0160SHC11

w" x d" x h"
29.5 x 29.25 x 46
Arm Height -
Seat Height 17.5
Inside Seat Depth 17
Inside Seat Width 29.5

COM	COL	1	2	3	4	5	6	7	8	9	10	11/L1	12	13/L2
2997	3088	3179	3270	3361	3452	3543	3634	3725	3816	3907	3998	4089	4180	4362

Upholstery Requirements
Fabric yds: 5 Leather Sq. Ft.: 90
Carton Weight: 60

Product Features

- Horizontal back provides easy ganging capabilities.
- Utilizes elastic webbing suspension that conforms to individual's lumbar curvatures for adaptive support.
- Upholstered Privacy Screen
- Upholstered screens can be specified in contrasting fabrics, vinyl, or leathers.
- All units are standard with 1" adjustable glides that allow for leveling

2 Select Finish

[Click to view finishes](#)

NA

3 Combination Fabrics

[Click to view finishes](#)

DARRAN is pleased to offer customers the design freedom of combination fabrics. When using fabric, vinyl or leather combinations, pricing/yardage requirements will be as follows:

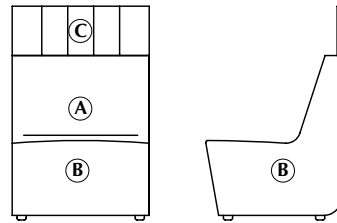

A Inside Back & Seat 2.5 yds
B Lounge Exterior 4 yds
C Privacy Screen 2 yd

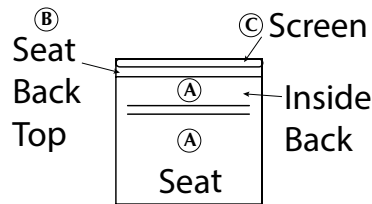

- When combining two materials of the same grade, pricing will be specified grade + 5%
- If combining two materials of different grades or leather/fabric combination, use the highest grade/price + 5%
- If using COM or COL, pricing will be COM or COL + 5%.
- If both COM + COL are used in combination, use COL + 5%.

Node Power Placement Option

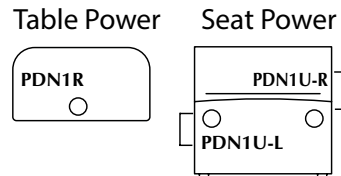

Options

Ganging Device

- GDEV-L: Left Facing Ganging Device - \$20
- GDEV-R: Right Facing Ganging Device - \$20
- GDEV-C: Center Ganging Device - \$40

Power

- PDN1U-L: Node in Left Facing Seat Front; 1 Power/1 USB Charger - \$355
- PDN1U-R: Node in Right Facing Seat Front; 1 Power/1 USB Charger - \$355
- PDN1U-B: Node in Both Left and Right Facing Seat Front; 1 Power/1 USB Charger per pod - \$709
- PDN1R- Node in Rear Mount Table Top; 1 Power/1 USB Charger - \$409
- Standard in White (Available in Silver and Black)
- 1/2" Compact Matte Laminate Rear Table**
- Matte Laminate RTD29: Rear Work Table - \$633

- Rear table available on units that gang providing stability
- Rear table is mounted at 35.5"

Premium Finish Option (Standard White)

- Specify rear table bracket Metal Finish color - \$100 per unit
- MFS: Silver, MFB: Black

Bota

Single Seat With Privacy Screen
High Back - 17.5" Privacy Screen

[Click here to view statement of line](#)

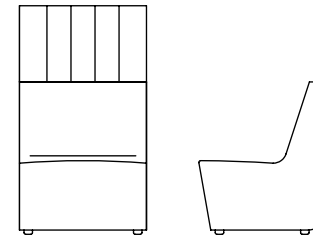

1 Model BOT0160SHC21

w" x d" x h"
29.5 x 29.25 x 53
Arm Height -
Seat Height 17.5
Inside Seat Depth 17
Inside Seat Width 29.5

COM	COL	1	2	3	4	5	6	7	8	9	10	11/L1	12	13/L2
3216	3316	3416	3516	3616	3716	3816	3916	4016	4116	4216	4316	4416	4516	4716

Upholstery Requirements
Fabric yds: 5.5 Leather Sq. Ft.: 99
Carton Weight: 65

Product Features

- Horizontal back provides easy ganging capabilities.
- Utilizes elastic webbing suspension that conforms to individual's lumbar curvatures for adaptive support.
- Upholstered Privacy Screen
- Upholstered screens can be specified in contrasting fabrics, vinyl, or leathers.
- All units are standard with 1" adjustable glides that allow for leveling

2 Select Finish

[Click to view finishes](#)

NA

3 Combination Fabrics

[Click to view finishes](#)

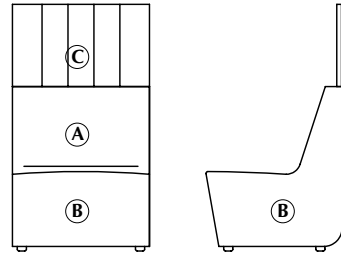

DARRAN is pleased to offer customers the design freedom of combination fabrics. When using fabric, vinyl or leather combinations, pricing/yardage requirements will be as follows:

- A Inside Back & Seat 1.5 yds
- B Lounge Exterior 3 yds
- C Privacy Screen 1.5 yds

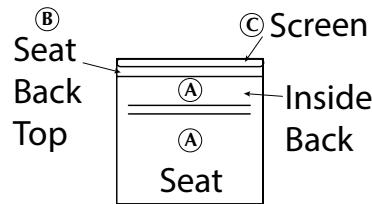

- When combining two materials of the same grade, pricing will be specified grade + 5%
- If combining two materials of different grades or leather/fabric combination, use the highest grade/price + 5%
- If using COM or COL, pricing will be COM or COL + 5%.
- If both COM + COL are used in combination, use COL + 5%.

Node Power Placement Option

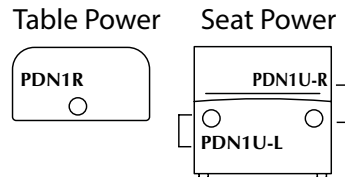

Options

Ganging Device

- GDEV-L: Left Facing Ganging Device - \$20
- GDEV-R: Right Facing Ganging Device - \$20
- GDEV-C: Center Ganging Device - \$40

Power

- PDN1U-L: Node in Left Facing Seat Front; 1 Power/1 USB Charger - \$355
- PDN1U-R: Node in Right Facing Seat Front; 1 Power/1 USB Charger - \$355
- PDN1U-B: Node in Both Left and Right Facing Seat Front; 1 Power/1 USB Charger per pod - \$709
- PDN1R- Node in Rear Mount Table Top; 1 Power/1 USB Charger - \$409
- Standard in White (Available in Silver and Black)

1/2" Compact Matte Laminate Rear Table

- Matte Laminate RTD29: Rear Work Table - \$633

- Rear table available on units that gang providing stability
- Rear table is mounted at 35.5"

Premium Finish Option (Standard White)

- Specify rear table bracket Metal Finish color - \$100 per unit
- MFS: Silver, MFB: Black

Bota

Double Seat
Low Back

[Click here to view statement of line](#)

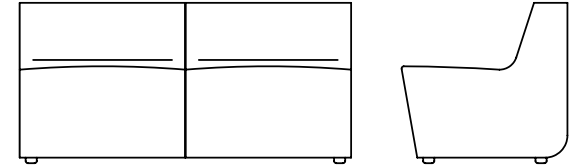

1 Model BOT0160DLC02

w" x d" x h"
59 x 29.25 x 28.5
Arm Height -
Seat Height 17.5
Inside Seat Depth 17
Inside Seat Width 29.5

COM	COL	1	2	3	4	5	6	7	8	9	10	11/L1	12	13/L2
3535	3644	3753	3862	3971	4080	4189	4298	4407	4516	4625	4734	4843	4952	5170

Upholstery Requirements
Fabric yds: 6 Leather Sq. Ft.: 108
Carton Weight: 90

2 Select Finish

[Click to view finishes](#)

NA

3 Combination Fabrics

[Click to view finishes](#)

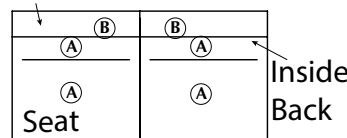
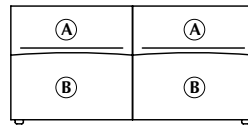
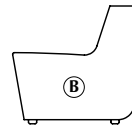

DARRAN is pleased to offer customers the design freedom of combination fabrics. When using fabric, vinyl or leather combinations, pricing/yardage requirements will be as follows:

A Inside Back & Seat 2 yds
B Lounge Exterior 4 yds

- When combining two materials of the same grade, pricing will be specified grade + 5%
- If combining two materials of different grades or leather/fabric combination, use the highest grade/price + 5%
- If using COM or COL, pricing will be COM or COL + 5%.
- If both COM + COL are used in combination, use COL + 5%.

Node Power Placement Option

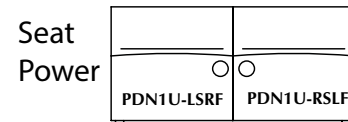

Product Features

- Horizontal back provides easy ganging capabilities.
- Utilizes elastic webbing suspension that conforms to individual's lumbar curvatures for adaptive support.
- All units are standard with 1" adjustable glides that allow for leveling

Options

Ganging Device

- GDEV-L: Left Facing Ganging Device - \$20
- GDEV-R: Right Facing Ganging Device - \$20
- GDEV-C: Center Ganging Device - \$40

Power

- PDN1U-LSRF: Node in Left Seat Right Facing Seat Front; 1 Power/1 USB Charger - \$355
- PDN1U-RSLF: Node in Right Seat Left Facing Seat Front; 1 Power/1 USB Charger - \$355
- PDN1U-BC: Node in Both Left and Right Facing Center Seat Front; 1 Power/1 USB Charger per pod - \$709
- PDN1R: Node in Rear Mount Table Top; 1 Power/1 USB Charger - \$409
- Standard in White (Available in Silver and Black)

1/2" Compact Matte Laminate Rear Table

- Matte Laminate RTD59: Rear Work Table - \$862

- Rear table available on units that gang providing stability
- Rear table is mounted at 28.5"

1/2" Compact Matte Laminate Tablet

- FFTD: 1/2" Compact Matte Laminate Tablet - \$622, Specify LAW Alaska or LNB Nero Finish
- Tablet is center mount only

Premium Finish Option (Standard White)

- Specify rear table bracket Metal Finish color - \$100 per unit
- Specify tablet Metal Finish color - \$100 per unit
- MFS: Silver, MFB: Black

Bota

Double Seat With Privacy Screen
 Low Back - 10.5" Privacy Screen

[Click here to view statement of line](#)

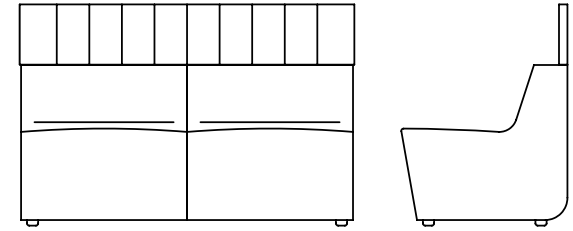

1 Model BOT0160DLC12

w" x d" x h"
 59 x 29.25 x 39
 Arm Height -
 Seat Height 17.5
 Inside Seat Depth 17
 Inside Seat Width 29.5

COM	COL	1	2	3	4	5	6	7	8	9	10	11/L1	12	13/L2
4524	4670	4816	4962	5108	5254	5400	5546	5692	5838	5984	6130	6276	6422	6714

Upholstery Requirements
 Fabric yds: 8 Leather Sq. Ft.: 144
 Carton Weight: 110

2 Select Finish

[Click to view finishes](#)

NA

3 Combination Fabrics

[Click to view finishes](#)

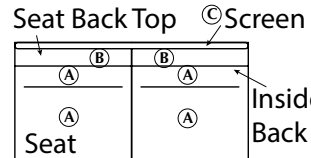
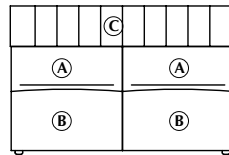
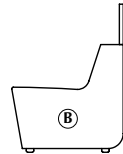

DARRAN is pleased to offer customers the design freedom of combination fabrics. When using fabric, vinyl or leather combinations, pricing/yardage requirements will be as follows:

- A Inside Back & Seat 2 yds
- B Lounge Exterior 4 yds
- C Privacy Screen 2 yds

- When combining two materials of the same grade, pricing will be specified grade + 5%
- If combining two materials of different grades or leather/fabric combination, use the highest grade/price + 5%
- If using COM or COL, pricing will be COM or COL + 5%.
- If both COM + COL are used in combination, use COL + 5%.

Node Power Placement Option

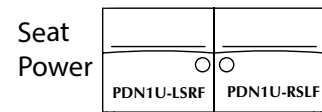

Product Features

- Horizontal back provides easy ganging capabilities.
- Utilizes elastic webbing suspension that conforms to individual's lumbar curvatures for adaptive support.
- Upholstered Privacy Screen
- Upholstered screens can be specified in contrasting fabrics, vinyl, or leathers.
- All units are standard with 1" adjustable glides that allow for leveling

Options

Ganging Device

- GDEV-L: Left Facing Ganging Device - \$20
- GDEV-R: Right Facing Ganging Device - \$20
- GDEV-C: Center Ganging Device - \$40

Power

- PDN1U-LSRF: Node in Left Seat Right Facing Seat Front; 1 Power/1 USB Charger - \$355
- PDN1U-RSLF: Node in Right Seat Left Facing Seat Front; 1 Power/1 USB Charger - \$355
- PDN1U-BC: Node in Both Left and Right Facing Center Seat Front; 1 Power/1 USB Charger per pod - \$709
- PDN1R- Node in Rear Mount Table Top; 1 Power/1 USB Charger - \$409
- Standard in White (Available in Silver and Black)

1/2" Compact Matte Laminate Rear Table

- Matte Laminate RTD59: Rear Work Table - \$862

- Rear table available on units that gang providing stability
- Rear table is mounted at 28.5"

1/2" Compact Matte Laminate Tablet

- FFD: 1/2" Compact Matte Laminate Tablet - \$622, Specify LAW Alaska/B Nero Finish
- Tablet is center mount only

Premium Finish Option (Standard White)

- Specify rear table bracket Metal Finish color - \$100 per unit
- Specify tablet Metal Finish color - \$100 per unit
- MFS: Silver, MFB: Black

Bota

Double Seat With Privacy Screen
 Low Back - 24.75" Privacy Screen

[Click here to view statement of line](#)

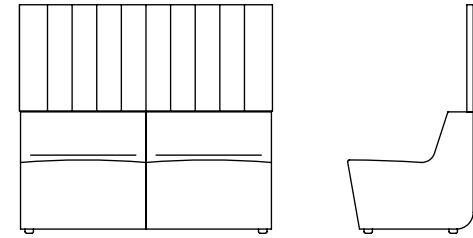

1 Model BOT0160DLC22

w" x d" x h"
 59 x 29.25 x 53.25
 Arm Height -
 Seat Height 17.5
 Inside Seat Depth 17
 Inside Seat Width 29.5

COM	COL	1	2	3	4	5	6	7	8	9	10	11/L1	12	13/L2
5352	5498	5644	5790	5936	6082	6228	6374	6520	6666	6812	6958	7104	7250	7542

Upholstery Requirements
 Fabric yds: 8 Leather Sq. Ft.: 144
 Carton Weight: 130

2 Select Finish

[Click to view finishes](#)

NA

3 Combination Fabrics

[Click to view finishes](#)

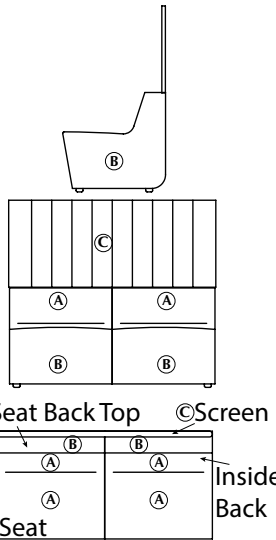

DARRAN is pleased to offer customers the design freedom of combination fabrics. When using fabric, vinyl or leather combinations, pricing/yardage requirements will be as follows:

- A Inside Back & Seat 2 yds
- B Lounge Exterior 4 yds
- C Privacy Screen 3.5 yds

- When combining two materials of the same grade, pricing will be specified grade + 5%
- If combining two materials of different grades or leather/fabric combination, use the highest grade/price + 5%
- If using COM or COL, pricing will be COM or COL + 5%.
- If both COM + COL are used in combination, use COL + 5%.

Node Power Placement Option

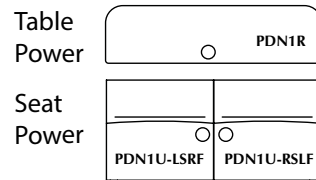

Product Features

- Horizontal back provides easy ganging capabilities.
- Utilizes elastic webbing suspension that conforms to individual's lumbar curvatures for adaptive support.
- Upholstered Privacy Screen
- Upholstered screens can be specified in contrasting fabrics, vinyl, or leathers.
- All units are standard with 1" adjustable glides that allow for leveling

Options

Ganging Device

- GDEV-L: Left Facing Ganging Device - \$20
- GDEV-R: Right Facing Ganging Device - \$20
- GDEV-C: Center Ganging Device - \$40

Power

- PDN1U-LSRF: Node in Left Seat Right Facing Seat Front; 1 Power/1 USB Charger - \$355
- PDN1U-RSLF: Node in Right Seat Left Facing Seat Front; 1 Power/1 USB Charger - \$355
- PDN1U-BC: Node in Both Left and Right Facing Center Seat Front; 1 Power/1 USB Charger per pod - \$709
- PDN1R: Node in Rear Mount Table Top; 1 Power/1 USB Charger - \$409
- Standard in White (Available in Silver and Black)

1/2" Compact Matte Laminate Rear Table

- Matte Laminate RTD59: Rear Work Table - \$862

- Rear table available on units that gang providing stability
- Rear table is mounted at 28.5"

1/2" Compact Matte Laminate Tablet

- FFTD: 1/2" Compact Matte Laminate Tablet - \$622, Specify LAW Alaska or LNB Nero Finish
- Tablet is center mount only

Premium Finish Option (Standard White)

- Specify rear table bracket Metal Finish color - \$100 per unit
- Specify tablet Metal Finish color - \$100 per unit
- MFS: Silver, MFB: Black

Bota

Double Seat
High Back

[Click here to view statement of line](#)

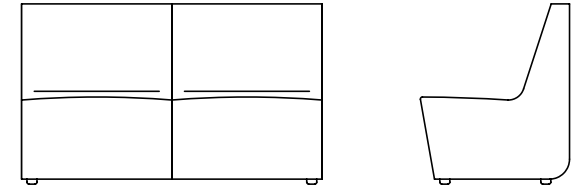

1 Model BOT0160DHC02

w" x d" x h"
59 x 29.25 x 35.5
Arm Height -
Seat Height 17.5
Inside Seat Depth 17
Inside Seat Width 29.5

COM	COL	1	2	3	4	5	6	7	8	9	10	11/L1	12	13/L2
3929	4048	4167	4286	4405	4524	4643	4762	4881	5000	5119	5238	5357	5476	5714

Upholstery Requirements
Fabric yds: 6.5 Leather Sq. Ft.: 117
Carton Weight: 95

2 Select Finish

[Click to view finishes](#)

NA

3 Combination Fabrics

[Click to view finishes](#)

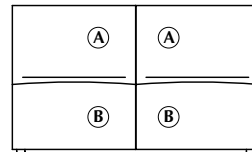
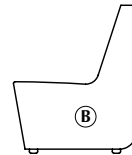

Seat Back Top

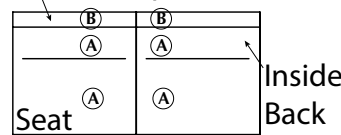

DARRAN is pleased to offer customers the design freedom of combination fabrics. When using fabric, vinyl or leather combinations, pricing/yardage requirements will be as follows:

A Inside Back & Seat 2.5 yds
B Lounge Exterior 4.5 yds

- When combining two materials of the same grade, pricing will be specified grade + 5%
- If combining two materials of different grades or leather/fabric combination, use the highest grade/price + 5%
- If using COM or COL, pricing will be COM or COL + 5%.
- If both COM + COL are used in combination, use COL + 5%.

Node Power Placement Option

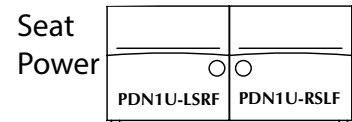

Product Features

- Horizontal back provides easy ganging capabilities.
- Utilizes elastic webbing suspension that conforms to individual's lumbar curvatures for adaptive support.
- All units are standard with 1" adjustable glides that allow for leveling

Options

Ganging Device

- GDEV-L: Left Facing Ganging Device - \$20
- GDEV-R: Right Facing Ganging Device - \$20
- GDEV-C: Center Ganging Device - \$40

Power

- PDN1U-LSRF: Node in Left Seat Right Facing Seat Front; 1 Power/1 USB Charger - \$355
- PDN1U-RSLF: Node in Right Seat Left Facing Seat Front; 1 Power/1 USB Charger - \$355
- PDN1U-BC: Node in Both Left and Right Facing Center Seat Front; 1 Power/1 USB Charger per pod - \$709
- PDN1R: Node in Rear Mount Table Top; 1 Power/1 USB Charger - \$409
- Standard in White (Available in Silver and Black)

1/2" Compact Matte Laminate Rear Table

- Matte Laminate RTD59: Rear Work Table - \$862, Specify LAW Alaska or LNB Nero Finish
- Rear table available on units that gang providing stability
- Rear table is mounted at 35.5"

1/2" Compact Matte Laminate Tablet

- FFTD: 1/2" Compact Matte Laminate Tablet - \$622

- Tablet is center mount only

Premium Finish Option (Standard White)

- Specify rear table bracket Metal Finish color - \$100 per unit
- Specify tablet Metal Finish color - \$100 per unit
- MFS: Silver, MFB: Black

DARRAN

Bota

Double Seat With Privacy Screen
High Back - 10.5" Privacy Screen

[Click here to view statement of line](#)

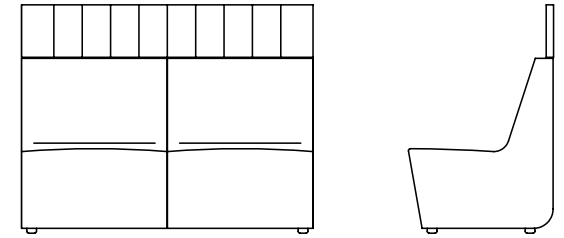

1 Model BOT0160DHC12

w" x d" x h"
59 x 29.25 x 46
Arm Height -
Seat Height 17.5
Inside Seat Depth 17
Inside Seat Width 29.5

COM	COL	1	2	3	4	5	6	7	8	9	10	11/L1	12	13/L2
4915	5070	5225	5380	5535	5690	5845	6000	6155	6310	6465	6620	6775	6930	7240

Upholstery Requirements
Fabric yds: 8.5 Leather Sq. Ft.: 153
Carton Weight: 115

2 Select Finish

[Click to view finishes](#)

NA

3 Combination Fabrics

[Click to view finishes](#)

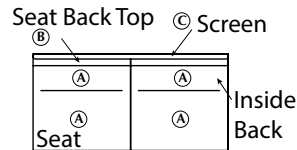
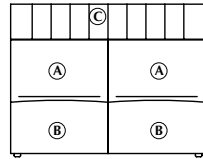
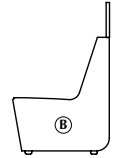

DARRAN is pleased to offer customers the design freedom of combination fabrics. When using fabric, vinyl or leather combinations, pricing/yardage requirements will be as follows:

- A Inside Back & Seat 2.5 yds
- B Lounge Exterior 4.5 yds
- C Privacy Screen 2 yds

- When combining two materials of the same grade, pricing will be specified grade + 5%
- If combining two materials of different grades or leather/fabric combination, use the highest grade/price + 5%
- If using COM or COL, pricing will be COM or COL + 5%.
- If both COM + COL are used in combination, use COL + 5%.

Node Power Placement Option

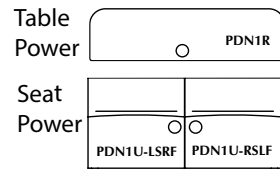

Product Features

- Horizontal back provides easy ganging capabilities.
- Utilizes elastic webbing suspension that conforms to individual's lumbar curvatures for adaptive support.
- Upholstered Privacy Screen
- Upholstered screens can be specified in contrasting fabrics, vinyl, or leathers.
- All units are standard with 1" adjustable glides that allow for leveling

Options

Ganging Device

- GDEV-L: Left Facing Ganging Device - \$20
- GDEV-R: Right Facing Ganging Device - \$20
- GDEV-C: Center Ganging Device - \$40

Power

- PDN1U-LSRF: Node in Left Seat Right Facing Seat Front; 1 Power/1 USB Charger - \$355
- PDN1U-RSLF: Node in Right Seat Left Facing Seat Front; 1 Power/1 USB Charger - \$355
- PDN1U-BC: Node in Both Left and Right Facing Center Seat Front; 1 Power/1 USB Charger per pod - \$709
- PDN1R: Node in Rear Mount Table Top; 1 Power/1 USB Charger - \$409
- Standard in White (Available in Silver and Black)

1/2" Compact Matte Laminate Rear Table

- Matte Laminate RTD59: Rear Work Table - \$862

- Rear table available on units that gang providing stability
- Rear table is mounted at 35.5"

1/2" Compact Matte Laminate Tablet

- FFTD: 1/2" Compact Matte Laminate Tablet - \$622, Specify LAW Alaska or LNB Nero Finish
- Tablet is center mount only

Premium Finish Option (Standard White)

- Specify rear table bracket Metal Finish color - \$100 per unit
- Specify tablet Metal Finish color - \$100 per unit
- MFS: Silver, MFB: Black

Bota

Double Seat With Privacy Screen
High Back - 17.5" Privacy Screen

[Click here to view statement of line](#)

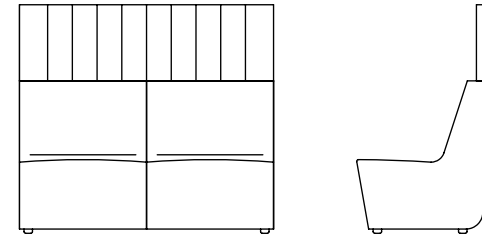

1 Model BOT0160DHC22

w" x d" x h"
59 x 29.25 x 53
Arm Height -
Seat Height 17.5
Inside Seat Depth 17
Inside Seat Width 29.5

COM	COL	1	2	3	4	5	6	7	8	9	10	11/L1	12	13/L2
5396	5588	5780	5972	6164	6356	6548	6740	6932	7124	7316	7508	7700	7892	8276

Upholstery Requirements
Fabric yds: 10.5 Leather Sq. Ft.: 189
Carton Weight: 135

2 Select Finish

[Click to view finishes](#)

NA

3 Combination Fabrics

[Click to view finishes](#)

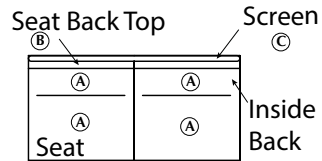
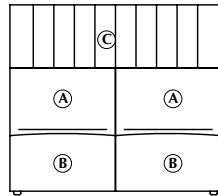
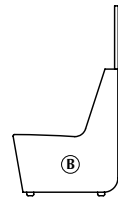

DARRAN is pleased to offer customers the design freedom of combination fabrics. When using fabric, vinyl or leather combinations, pricing/yardage requirements will be as follows:

- A Inside Back & Seat 2.5 yds
- B Lounge Exterior 4.5 yds
- C Privacy Screen 4 yds

- When combining two materials of the same grade, pricing will be specified grade + 5%
- If combining two materials of different grades or leather/fabric combination, use the highest grade/price + 5%
- If using COM or COL, pricing will be COM or COL + 5%.
- If both COM + COL are used in combination, use COL + 5%.

Node Power Placement Option

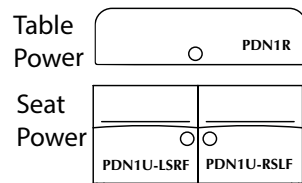

Product Features

- Horizontal back provides easy ganging capabilities.
- Utilizes elastic webbing suspension that conforms to individual's lumbar curvatures for adaptive support.
- Upholstered Privacy Screen
- Upholstered screens can be specified in contrasting fabrics, vinyl, or leathers.
- All units are standard with 1" adjustable glides that allow for leveling

Options

Ganging Device

- GDEV-L: Left Facing Ganging Device - \$20
- GDEV-R: Right Facing Ganging Device - \$20
- GDEV-C: Center Ganging Device - \$40

Power

- PDN1U-LSRF: Node in Left Seat Right Facing Seat Front; 1 Power/1 USB Charger - \$355
- PDN1U-RSLF: Node in Right Seat Left Facing Seat Front; 1 Power/1 USB Charger - \$355
- PDN1U-BC: Node in Both Left and Right Facing Center Seat Front; 1 Power/1 USB Charger per pod - \$709
- PDN1R: Node in Rear Mount Table Top; 1 Power/1 USB Charger - \$409
- Standard in White (Available in Silver and Black)

1/2" Compact Matte Laminate Rear Table

- Matte Laminate RTD59: Rear Work Table - \$862

- Rear table available on units that gang providing stability
- Rear table is mounted at 35.5"

1/2" Compact Matte Laminate Tablet

- FFTD: 1/2" Compact Matte Laminate Tablet - \$622, Specify LAW Alaska/B Nero Finish
- Tablet is center mount only

Premium Finish Option (Standard White)

- Specify rear table bracket Metal Finish color - \$100 per unit
- Specify tablet Metal Finish color - \$100 per unit
- MFS: Silver, MFB: Black

Bota

Triple Seat
Low Back

[Click here to view statement of line](#)

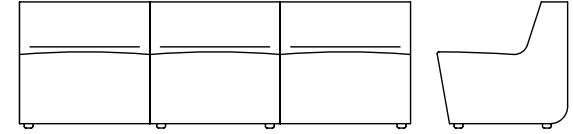

1 Model BOT0160TLC03

w" x d" x h"
88.5 x 29.25 x 28.5
Arm Height -
Seat Height 17.5
Inside Seat Depth 17
Inside Seat Width 29.5

COM	COL	1	2	3	4	5	6	7	8	9	10	11/L1	12	13/L2
4961	5125	5289	5453	5617	5781	5945	6109	6273	6437	6601	6765	6929	7093	7421

Upholstery Requirements
Fabric yds: 8 Leather Sq. Ft.: 144
Carton Weight: 135

2 Select Finish

[Click to view finishes](#)

NA

3 Combination Fabrics

[Click to view finishes](#)

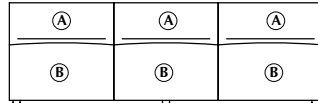
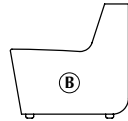

Seat Back Top

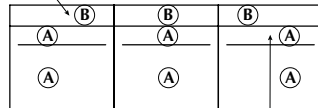

Inside Back

Node Power Placement Option

Table Power

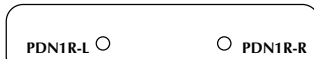

Seat Power

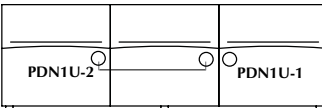

DARRAN is pleased to offer customers the design freedom of combination fabrics. When using fabric, vinyl or leather combinations, pricing/yardage requirements will be as follows:

A Inside Back & Seat 3 yds
B Lounge Exterior 6 yds

- When combining two materials of the same grade, pricing will be specified grade + 5%
- If combining two materials of different grades or leather/fabric combination, use the highest grade/price + 5%
- If using COM or COL, pricing will be COM or COL + 5%.
- If both COM + COL are used in combination, use COL + 5%.

Product Features

- Horizontal back provides easy ganging capabilities.
- Utilizes elastic webbing suspension that conforms to individual's lumbar curvatures for adaptive support.
- All units are standard with 1" adjustable glides that allow for leveling

Options

Ganging Device

- GDEV-L: Left Facing Ganging Device - \$20
- GDEV-R: Right Facing Ganging Device - \$20
- GDEV-C: Center Ganging Device - \$40

Power

- PDN1U-1: Node in Right Facing Seat Front; 1 Power/1 USB Charger - \$355
- PDN1U-2: Node in Left and Center Seat, Right Facing Seat Fronts; 1 power/1 USB per pod - \$709
- PDN1R-R: Node in Right Facing Rear Mount Table Top; 1 Power/1 USB Charger - \$409
- PDN2R-L- 2 Node in Left Facing Rear Mount Table Top; 1 Power/1 USB Charger - \$375
- Standard in White (Available in Silver and Black)

1/2" Compact Matte Laminate Rear Table

- Matte Laminate RTD88: Rear Work Table - \$1,096, Specify LAW Alaska or LNB Nero Finish
- Rear table available on units that gang providing stability
- Rear table is mounted at 28.5"

1/2" Compact Matte Laminate Tablet

- FFTD: 1/2" Compact Matte Laminate Tablet - \$622

- Tablet mounts left or right of center cushion

Premium Finish Option (Standard White)

- Specify rear table bracket Metal Finish color - \$100 per unit
- Specify tablet Metal Finish color - \$100 per unit
- MFS: Silver, MFB: Black

Bota

Triple Seat With Privacy Screen
 Low Back - 10.5" Privacy Screen

[Click here to view statement of line](#)

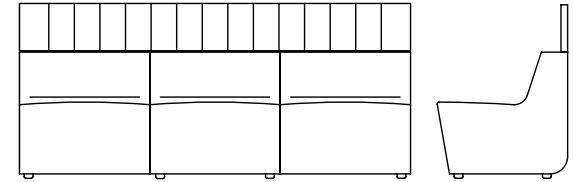

1 Model BOT0160TLC13

w" x d" x h"
 88.5 x 29.25 x 39
 Arm Height -
 Seat Height 17.5
 Inside Seat Depth 17
 Inside Seat Width 29.5

COM	COL	1	2	3	4	5	6	7	8	9	10	11/L1	12	13/L2
6366	6558	6750	6942	7134	7326	7518	7710	7902	8094	8286	8478	8670	8862	9246

Upholstery Requirements
 Fabric yds: 10.5 Leather Sq. Ft.: 189
 Carton Weight: 165

2 Select Finish

[Click to view finishes](#)

NA

3 Combination Fabrics

[Click to view finishes](#)

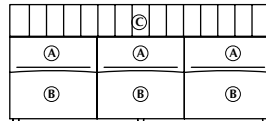
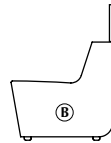

B Seat Back Top Screen C

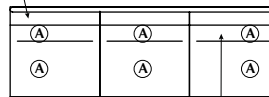

Inside Back

Node Power Placement Option

Table Power



Seat Power

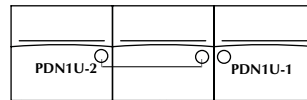

DARRAN is pleased to offer customers the design freedom of combination fabrics. When using fabric, vinyl or leather combinations, pricing/yardage requirements will be as follows:

- A Inside Back & Seat 3 yds
- B Lounge Exterior 6 yds
- C Privacy Screen 2.5 yds

- When combining two materials of the same grade, pricing will be specified grade + 5%
- If combining two materials of different grades or leather/fabric combination, use the highest grade/price + 5%
- If using COM or COL, pricing will be COM or COL + 5%.
- If both COM + COL are used in combination, use COL + 5%.

Product Features

- Horizontal back provides easy ganging capabilities.
- Utilizes elastic webbing suspension that conforms to individual's lumbar curvatures for adaptive support.
- Upholstered Privacy Screen
- Upholstered screens can be specified in contrasting fabrics, vinyl, or leathers.
- All units are standard with 1" adjustable glides that allow for leveling

Options

Ganging Device

- GDEV-L: Left Facing Ganging Device - \$20
- GDEV-R: Right Facing Ganging Device - \$20
- GDEV-C: Center Ganging Device - \$40

Power

- PDN1U-1: Node in Right Facing Seat Front; 1 Power/1 USB Charger - \$355
- PDN1U-2: Node in Left and Center Seat, Right Facing Seat Fronts; 1 power/1 USB per pod - \$709
- PDN1R-R: Node in Right Facing Rear Mount Table Top; 1 Power/1 USB Charger - \$409
- PDN2R-L- 2 Node in Left Facing Rear Mount Table Top; 1 Power/1 USB Charger - \$375

- Standard in White (Available in Silver and Black)

1/2" Compact Matte Laminate Rear Table

- Matte Laminate RTD88: Rear Work Table - \$1,096

- Rear table available on units that gang providing stability
- Rear table is mounted at 28.5"

1/2" Compact Matte Laminate Tablet

- FFTD: 1/2" Compact Matte Laminate Tablet - \$622, Specify LAW Alaska or LNB Nero Finish
- Tablet mounts left or right of center cushion

Premium Finish Option (Standard White)

- Specify rear table bracket Metal Finish color - \$100 per unit
- Specify tablet Metal Finish color - \$100 per unit
- MFS: Silver, MFB: Black

Bota

Triple Seat With Privacy Screen
 Low Back - 24.75" Privacy Screen

[Click here to view statement of line](#)

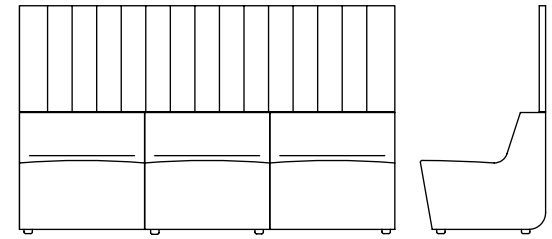

1 Model BOT0160TLC23

w" x d" x h"
 88.5 x 29.25 x 53.25
 Arm Height -
 Seat Height 17.5
 Inside Seat Depth 17
 Inside Seat Width 29.5

COM	COL	1	2	3	4	5	6	7	8	9	10	11/L1	12	13/L2
7385	7622	7859	8096	8333	8570	8807	9044	9281	9518	9755	9992	10229	10466	10940

Upholstery Requirements
 Fabric yds: 13 Leather Sq. Ft.: 234
 Carton Weight: 195

2 Select Finish

[Click to view finishes](#)

NA

3 Combination Fabrics

[Click to view finishes](#)

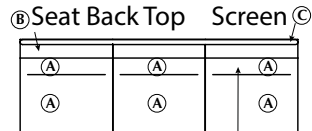
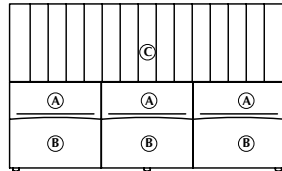
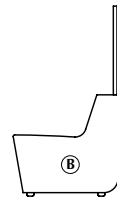

Inside Back

DARRAN is pleased to offer customers the design freedom of combination fabrics. When using fabric, vinyl or leather combinations, pricing/yardage requirements will be as follows:

- A Inside Back & Seat 3 yds
- B Lounge Exterior 6 yds
- C Privacy Screen 5 yds

- When combining two materials of the same grade, pricing will be specified grade + 5%
- If combining two materials of different grades or leather/fabric combination, use the highest grade/price + 5%
- If using COM or COL, pricing will be COM or COL + 5%.
- If both COM + COL are used in combination, use COL + 5%.

Node Power Placement Option

Table Power



Seat Power

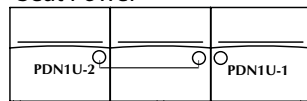

Product Features

- Horizontal back provides easy ganging capabilities.
- Utilizes elastic webbing suspension that conforms to individual's lumbar curvatures for adaptive support.
- Upholstered Privacy Screen
- Upholstered screens can be specified in contrasting fabrics, vinyl, or leathers.
- All units are standard with 1" adjustable glides that allow for leveling

Options

Ganging Device

- GDEV-L: Left Facing Ganging Device - \$20
- GDEV-R: Right Facing Ganging Device - \$20
- GDEV-C: Center Ganging Device - \$40

Power

- PDN1U-1: Node in Right Facing Seat Front; 1 Power/1 USB Charger - \$355
- PDN1U-2: Node in Left and Center Seat, Right Facing Seat Fronts; 1 power/1 USB per pod - \$709
- PDN1R-R: Node in Right Facing Rear Mount Table Top; 1 Power/1 USB Charger - \$409
- PDN2R-L- 2 Node in Left Facing Rear Mount Table Top; 1 Power/1 USB Charger - \$375

- Standard in White (Available in Silver and Black)

1/2" Compact Matte Laminate Rear Table

- Matte Laminate RTD88: Rear Work Table - \$1,096

- Rear table available on units that gang providing stability
- Rear table is mounted at 28.5"

1/2" Compact Matte Laminate Tablet

- FFTD: 1/2" Compact Matte Laminate Tablet - \$622, Specify LAW Alaska or LNB Nero Finish
- Tablet mounts left or right of center cushion

Premium Finish Option (Standard White)

- Specify rear table bracket Metal Finish color - \$100 per unit
- Specify tablet Metal Finish color - \$100 per unit
- MFS: Silver, MFB: Black

Bota

Triple Seat
High Back

[Click here to view statement of line](#)

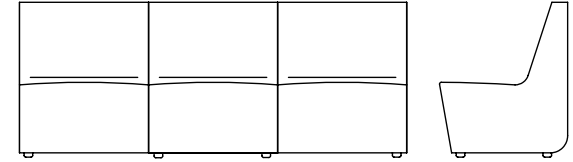

1 Model BOT0160THC03

w" x d" x h"
88.5 x 29.25 x 35.5
Arm Height -
Seat Height 17.5
Inside Seat Depth 17
Inside Seat Width 29.5

COM	COL	1	2	3	4	5	6	7	8	9	10	11/L1	12	13/L2
5398	5562	5726	5890	6054	6218	6382	6546	6710	6874	7038	7202	7366	7530	7858

Upholstery Requirements
Fabric yds: 9 Leather Sq. Ft.: 162
Carton Weight: 143

2 Select Finish

[Click to view finishes](#)

NA

3 Combination Fabrics

[Click to view finishes](#)

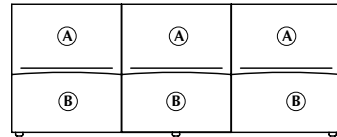

DARRAN is pleased to offer customers the design freedom of combination fabrics. When using fabric, vinyl or leather combinations, pricing/yardage requirements will be as follows:

A Inside Back & Seat 3.5 yds
B Lounge Exterior 6.5 yds

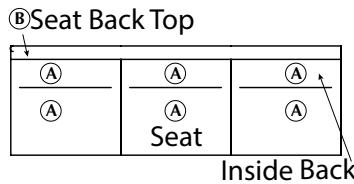

Node Power Placement Option

Table Power

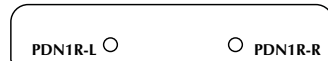

Seat Power

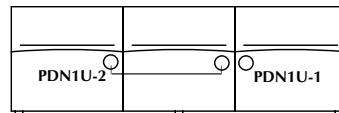

- When combining two materials of the same grade, pricing will be specified grade + 5%
- If combining two materials of different grades or leather/fabric combination, use the highest grade/price + 5%
- If using COM or COL, pricing will be COM or COL + 5%.
- If both COM + COL are used in combination, use COL + 5%.

Product Features

- Horizontal back provides easy ganging capabilities.
- Utilizes elastic webbing suspension that conforms to individual's lumbar curvatures for adaptive support.
- All units are standard with 1" adjustable glides that allow for leveling

Options

Ganging Device

- GDEV-L: Left Facing Ganging Device - \$20
- GDEV-R: Right Facing Ganging Device - \$20
- GDEV-C: Center Ganging Device - \$40

Power

- PDN1U-1: Node in Right Facing Seat Front; 1 Power/1 USB Charger - \$355
- PDN1U-2: Node in Left and Center Seat, Right Facing Seat Fronts; 1 power/1 USB per pod - \$709
- PDN1R-R: Node in Right Facing Rear Mount Table Top; 1 Power/1 USB Charger - \$409
- PDN2R-L- 2 Node in Left Facing Rear Mount Table Top; 1 Power/1 USB Charger - \$375
- Standard in White (Available in Silver and Black)

1/2" Compact Matte Laminate Rear Table

- Matte Laminate RTD88: Rear Work Table - \$1,096, Specify LAW Alaska or LNB Nero Finish
- Rear table available on units that gang providing stability
- Rear table is mounted at 35.5"

1/2" Compact Matte Laminate Tablet

- FFTD: 1/2" Compact Matte Laminate Tablet - \$622

- Tablet mounts left or right of center cushion

Premium Finish Option (Standard White)

- Specify rear table bracket Metal Finish color - \$100 per unit
- Specify tablet Metal Finish color - \$100 per unit
- MFS: Silver, MFB: Black

Bota

Triple Seat With Privacy Screen
High Back - 10.5" Privacy Screen

[Click here to view statement of line](#)

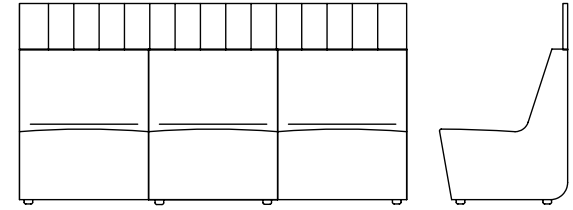

1 Model BOT0160THC13

w" x d" x h"
88.5 x 29.25 x 46
Arm Height -
Seat Height 17.5
Inside Seat Depth 17
Inside Seat Width 29.5

COM	COL	1	2	3	4	5	6	7	8	9	10	11/L1	12	13/L2
6780	6990	7200	7410	7620	7830	8040	8250	8460	8670	8880	9090	9300	9510	9930

Upholstery Requirements
Fabric yds: 11.5 Leather Sq. Ft.: 207
Carton Weight: 173

2 Select Finish

[Click to view finishes](#)

NA

3 Combination Fabrics

[Click to view finishes](#)

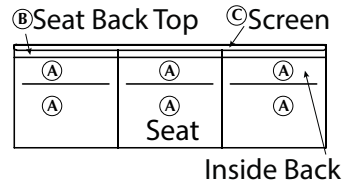
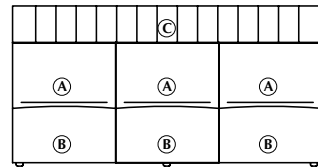
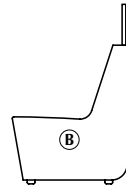

DARRAN is pleased to offer customers the design freedom of combination fabrics. When using fabric, vinyl or leather combinations, pricing/yardage requirements will be as follows:

- A Inside Back & Seat 3.5 yds
- B Lounge Exterior 6.5 yds
- C Privacy Screen 2.5 yds

- When combining two materials of the same grade, pricing will be specified grade + 5%
- If combining two materials of different grades or leather/fabric combination, use the highest grade/price + 5%
- If using COM or COL, pricing will be COM or COL + 5%.
- If both COM + COL are used in combination, use COL + 5%.

Node Power Placement Option

Table Power

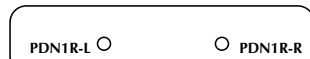

Seat Power

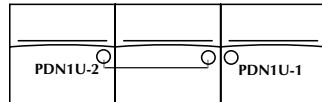

Product Features

- Horizontal back provides easy ganging capabilities.
- Utilizes elastic webbing suspension that conforms to individual's lumbar curvatures for adaptive support.
- Upholstered Privacy Screen
- Upholstered screens can be specified in contrasting fabrics, vinyl, or leathers.
- All units are standard with 1" adjustable glides that allow for leveling

Options

Ganging Device

- GDEV-L: Left Facing Ganging Device - \$20
- GDEV-R: Right Facing Ganging Device - \$20
- GDEV-C: Center Ganging Device - \$40

Power

- PDN1U-1: Node in Right Facing Seat Front; 1 Power/1 USB Charger - \$355
- PDN1U-2: Node in Left and Center Seat, Right Facing Seat Fronts; 1 power/1 USB per pod - \$709
- PDN1R-R: Node in Right Facing Rear Mount Table Top; 1 Power/1 USB Charger - \$409
- PDN2R-L- 2 Node in Left Facing Rear Mount Table Top; 1 Power/1 USB Charger - \$375

- Standard in White (Available in Silver and Black)

1/2" Compact Matte Laminate Rear Table

- Matte Laminate RTD88: Rear Work Table - \$1,096

- Rear table available on units that gang providing stability
- Rear table is mounted at 35.5"

1/2" Compact Matte Laminate Tablet

- FFD: 1/2" Compact Matte Laminate Tablet - \$622, Specify LAW Alaska or LNB Nero Finish
- Tablet mounts left or right of center cushion

Premium Finish Option (Standard White)

- Specify rear table bracket Metal Finish color - \$100 per unit
- Specify tablet Metal Finish color - \$100 per unit
- MFS: Silver, MFB: Black

Bota

Triple Seat With Privacy Screen
High Back - 17.5" Privacy Screen

[Click here to view statement of line](#)

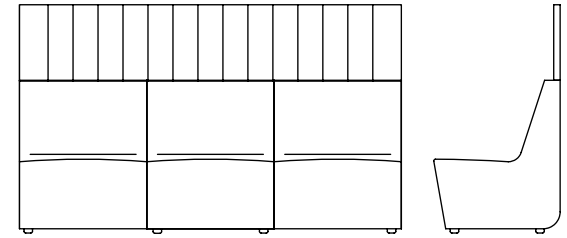

1 Model BOT0160THC23

w" x d" x h"
88.5 x 29.25 x 53
Arm Height -
Seat Height 17.5
Inside Seat Depth 17
Inside Seat Width 29.5

COM	COL	1	2	3	4	5	6	7	8	9	10	11/L1	12	13/L2
7367	7622	7877	8132	8387	8642	8897	9152	9407	9662	9917	10172	10427	10682	11192

Upholstery Requirements
Fabric yds: 14 Leather Sq. Ft.: 252
Carton Weight: 203

2 Select Finish

[Click to view finishes](#)

NA

3 Combination Fabrics

[Click to view finishes](#)

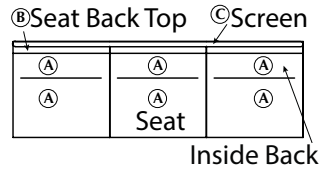
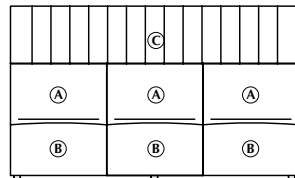
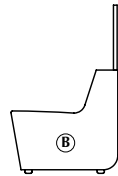

DARRAN is pleased to offer customers the design freedom of combination fabrics. When using fabric, vinyl or leather combinations, pricing/yardage requirements will be as follows:

- A Inside Back & Seat 3.5 yds
- B Lounge Exterior 6.5 yds
- C Privacy Screen 5 yds

- When combining two materials of the same grade, pricing will be specified grade + 5%
- If combining two materials of different grades or leather/fabric combination, use the highest grade/price + 5%
- If using COM or COL, pricing will be COM or COL + 5%.
- If both COM + COL are used in combination, use COL + 5%.

Node Power Placement Option

Table Power



Seat Power

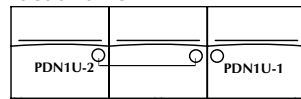

Product Features

- Horizontal back provides easy ganging capabilities.
- Utilizes elastic webbing suspension that conforms to individual's lumbar curvatures for adaptive support.
- Upholstered Privacy Screen
- Upholstered screens can be specified in contrasting fabrics, vinyl, or leathers.
- All units are standard with 1" adjustable glides that allow for leveling

Options

Ganging Device

- GDEV-L: Left Facing Ganging Device - \$20
- GDEV-R: Right Facing Ganging Device - \$20
- GDEV-C: Center Ganging Device - \$40

Power

- PDN1U-1: Node in Right Facing Seat Front; 1 Power/1 USB Charger - \$355
- PDN1U-2: Node in Left and Center Seat, Right Facing Seat Fronts; 1 power/1 USB per pod - \$709
- PDN1R-R: Node in Right Facing Rear Mount Table Top; 1 Power/1 USB Charger - \$409
- PDN2R-L- 2 Node in Left Facing Rear Mount Table Top; 1 Power/1 USB Charger - \$375

- Standard in White (Available in Silver and Black)

1/2" Compact Matte Laminate Rear Table

- Matte Laminate RTD88: Rear Work Table - \$1,096,

- Rear table available on units that gang providing stability
- Rear table is mounted at 35.5"

1/2" Compact Matte Laminate Tablet

- FFD: 1/2" Compact Matte Laminate Tablet - \$622, Specify LAW Alaska or LNB Nero Finish
- Tablet mounts left or right of center cushion

Premium Finish Option (Standard White)

- Specify rear table bracket Metal Finish color - \$100 per unit
- Specify tablet Metal Finish color - \$100 per unit
- MFS: Silver, MFB: Black

Bota

Shell - Single Seat
 Low Back - Side Screens & Privacy Screen

[Click here to view statement of line](#)

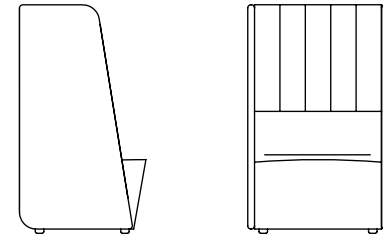

1 Model BOT0160SLN01

w" x d" x h"
 32.75 x 29.25 x 53
 Arm Height -
 Seat Height 17.5
 Inside Seat Depth 17
 Inside Seat Width 29.5

COM	COL	1	2	3	4	5	6	7	8	9	10	11/L1	12	13/L2
4893	5002	5111	5220	5329	5438	5547	5656	5765	5874	5983	6092	6201	6310	6528

Upholstery Requirements
 Fabric yds: 6 Leather Sq. Ft.: 108
 Carton Weight: 110

2 Select Finish

[Click to view finishes](#)

NA

3 Combination Fabrics

[Click to view finishes](#)

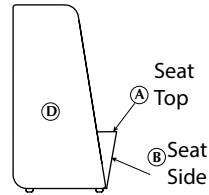
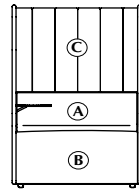

Top View

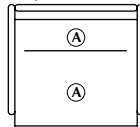

Node Power Placement Option

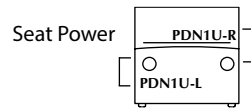

Table Power NA

DARRAN is pleased to offer customers the design freedom of combination fabrics. When using fabric, vinyl or leather combinations, pricing/yardage requirements will be as follows:

- A Inside Back & Seat 1.5 yds
- B Lounge Exterior 3 yds
- C Privacy Screen Interior 1 yds
- D Side Screens, Lounge Exterior, Privacy Screens 5 yds

- When combining two materials of the same grade, pricing will be specified grade + 5%
- If combining two materials of different grades or leather/fabric combination, use the highest grade/price + 5%
- If using COM or COL, pricing will be COM or COL + 5%.
- If both COM + COL are used in combination, use COL + 5%.

Product Features

- Screens are constructed from tubular metal that is welded to maximize the strength, precise measurements and overall longevity.
- Horizontal back provides easy ganging capabilities.
- Utilizes elastic webbing suspension that conforms to individual's lumbar curvatures for adaptive support.
- Upholstered screens can be specified in contrasting fabrics, vinyl, or leathers.
- All units are standard with 1" adjustable glides that allow for leveling

Notes

- Please consult customer service when specifying a table other than Bota to ensure adequacy of seat access
- When delete side screen option is specified, ganging brackets are installed on the lounge side. If the unit will be open specify the delete screen non-ganging option. Non-ganging option will not have side mounted ganging brackets

Options

Delete Side Screen

Delete Left Screen

- DLSG: Delete Left Side Screen for Ganging - Deduct \$500 (Ganging Hardware Installed)

- DLSN: Delete Left Side Screen for Non-Ganging - Deduct \$475 (Ganging Hardware Not Installed)

Delete Right Screen

- DRSG: Delete Right Side Screen for Ganging - Deduct \$500 (Ganging Hardware Installed)

- DRSN: Delete Right Side Screen for Non-Ganging - Deduct \$475 (Ganging Hardware Not Installed)

Power

- PDN1U-L: Node in Left Facing Seat Front; 1 Power/1 USB Charger - \$355
- PDN1U-R: Node in Right Facing Seat Front; 1 Power/1 USB Charger - \$355

- PDN1U-B: Node in Both Left and Right Facing Seat Front; 1 Power/1 USB Charger per pod - \$709

- Standard in White (Available in Silver and Black)

Bota

Shell - Single Seat
High Back - Side Screens & Privacy Screen

[Click here to view statement of line](#)

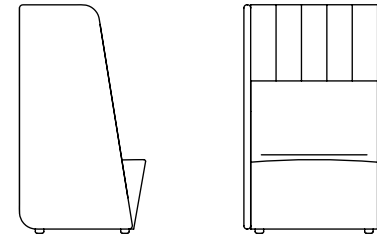

1 Model BOT0160SHN01

w" x d" x h"
32.75 x 29.25 x 53
Arm Height -
Seat Height 17.5
Inside Seat Depth 17
Inside Seat Width 29.5

COM	COL	1	2	3	4	5	6	7	8	9	10	11/L1	12	13/L2
4922	5050	5178	5306	5434	5562	5690	5818	5946	6074	6202	6330	6458	6586	6842

Upholstery Requirements
Fabric yds: 7 Leather Sq. Ft.: 126
Carton Weight: 115

2 Select Finish

[Click to view finishes](#)

NA

3 Combination Fabrics

[Click to view finishes](#)

DARRAN is pleased to offer customers the design freedom of combination fabrics. When using fabric, vinyl or leather combinations, pricing/yardage requirements will be as follows:

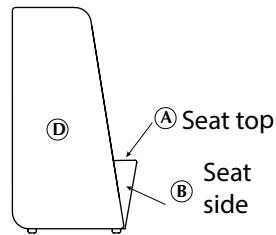
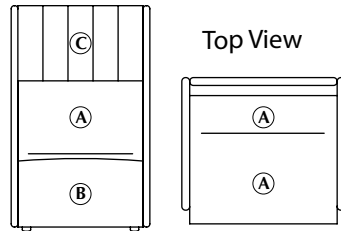

- A Inside Back & Seat 1.5 yds
- B Lounge Exterior 3 yds
- C Privacy Screen 0.75 yds
- D Side Screens, Lounge Exterior, Privacy Screens 5 yds

- When combining two materials of the same grade, pricing will be specified grade + 5%
- If combining two materials of different grades or leather/fabric combination, use the highest grade/price + 5%
- If using COM or COL, pricing will be COM or COL + 5%.
- If both COM + COL are used in combination, use COL + 5%.

Node Power Placement Option

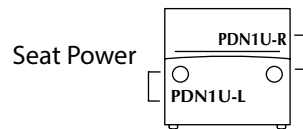

Table Power NA

Product Features

- Screens are constructed from tubular metal that is welded to maximize the strength, precise measurements and overall longevity.
- Horizontal back provides easy ganging capabilities.
- Utilizes elastic webbing suspension that conforms to individual's lumbar curvatures for adaptive support.
- Upholstered screens can be specified in contrasting fabrics, vinyl, or leathers.
- All units are standard with 1" adjustable glides that allow for leveling

Notes

- Please consult customer service when specifying a table other than Bota to ensure adequacy of seat access
- When delete side screen option is specified, ganging brackets are installed on the lounge side. If the unit will be open specify the delete screen non-ganging option. Non-ganging option will not have side mounted ganging brackets

Options

Delete Side Screen

Delete Left Screen

- DLSG: Delete Left Side Screen for Ganging - Deduct \$500 (Ganging Hardware Installed)

- DLSN: Delete Left Side Screen for Non-Ganging - Deduct \$475 (Ganging Hardware Not Installed)

Delete Right Screen

- DRSG: Delete Right Side Screen for Ganging - Deduct \$500 (Ganging Hardware Installed)

- DRSN: Delete Right Side Screen for Non-Ganging - Deduct \$475 (Ganging Hardware Not Installed)

Power

- PDN1U-L: Node in Left Facing Seat Front; 1 Power/1 USB Charger - \$355

- PDN1U-R: Node in Right Facing Seat Front; 1 Power/1 USB Charger - \$355

- PDN1U-B: Node in Both Left and Right Facing Seat Front; 1 Power/1 USB Charger per pod - \$709

- Standard in White (Available in Silver and Black)

Bota

Shell - Single Seat

Low Back - Side Screens, Privacy Screen & Roof

[Click here to view statement of line](#)

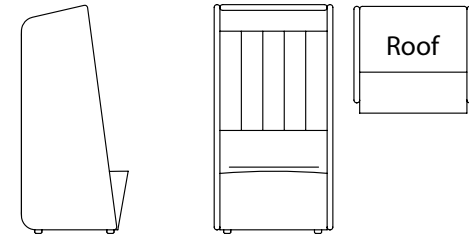

1 Model BOT0160SLR01

w" x d" x h"
32.75 x 29.25 x 63
Arm Height -
Seat Height 17.5
Inside Seat Depth 17
Inside Seat Width 29.5

COM	COL	1	2	3	4	5	6	7	8	9	10	11/L1	12	13/L2
6002	6130	6258	6386	6514	6642	6770	6898	7026	7154	7282	7410	7538	7666	7922

Upholstery Requirements
Fabric yds: 7 Leather Sq. Ft.: 126
Carton Weight: 131

2 Select Finish

[Click to view finishes](#)

NA

3 Combination Fabrics

[Click to view finishes](#)

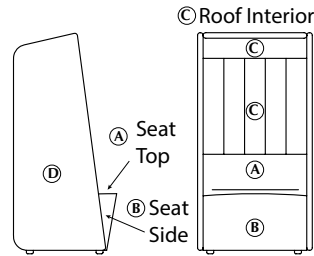

© Roof Interior

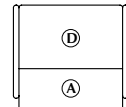

Ⓓ Roof Top View

Node Power Placement Option

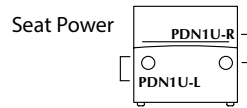

Table Power NA

DARRAN is pleased to offer customers the design freedom of combination fabrics. When using fabric, vinyl or leather combinations, pricing/yardage requirements will be as follows:

- A Inside Back & Seat 1.5 yds
- B Lounge Exterior 3 yds
- C Privacy Screen & Roof Interior 2 yds
- D Side Screens, Lounge Exterior, Roof Exterior 6 yds

- When combining two materials of the same grade, pricing will be specified grade + 5%
- If combining two materials of different grades or leather/fabric combination, use the highest grade/price + 5%
- If using COM or COL, pricing will be COM or COL + 5%.
- If both COM + COL are used in combination, use COL + 5%.

Product Features

- Screens are constructed from tubular metal that is welded to maximize the strength, precise measurements and overall longevity.
- Horizontal back provides easy ganging capabilities.
- Utilizes elastic webbing suspension that conforms to individual's lumbar curvatures for adaptive support.
- Upholstered screens & roof can be specified in contrasting fabrics, vinyl, or leathers.
- All units are standard with 1" adjustable glides that allow for leveling

Notes

- Please consult customer service when specifying a table other than Bota to ensure adequacy of seat access

Options

Power

- PDN1U-L: Node in Left Facing Seat Front; 1 Power/1 USB Charger - \$325
- PDN1U-R: Node in Right Facing Seat Front; 1 Power/1 USB Charger - \$355
- PDN1U-B: Node in Both Left and Right Facing Seat Front; 1 Power/1 USB Charger per pod - \$709
- Standard in White (Available in Silver and Black)

Bota

Work Shell
Single - Seat

[Click here to view statement of line](#)

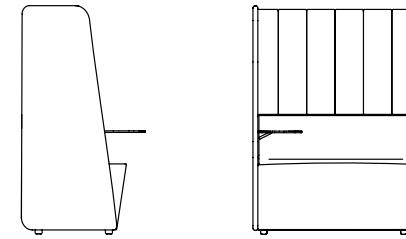

1 Model BOT0160SLW01

w" x d" x h"
38.75 x 29.25 x 53
Arm Height -
Seat Height 17.5
Inside Seat Depth 17
Inside Seat Width 35

COM	COL	1	2	3	4	5	6	7	8	9	10	11/L1	12	13/L2
6688	6816	6944	7072	7200	7328	7456	7584	7712	7840	7968	8096	8224	8352	8608

Upholstery Requirements
Fabric yds: 7 Leather Sq. Ft.: 126
Carton Weight: 130

2 Select Finish

[Click to view finishes](#)

3 Combination Fabrics

[Click to view finishes](#)

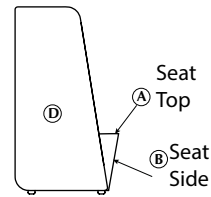
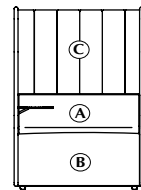

Top View

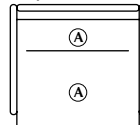

Node Power Placement Option

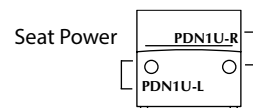

Table Power NA

DARRAN is pleased to offer customers the design freedom of combination fabrics. When using fabric, vinyl or leather combinations, pricing/yardage requirements will be as follows:

- A Inside Back & Seat 3.5 yds
- B Lounge Exterior 5 yds
- C Privacy Screen Interior 3 yds
- D Side Screens, Lounge Exterior, Privacy Screens 5 yds

- When combining two materials of the same grade, pricing will be specified grade + 5%
- If combining two materials of different grades or leather/fabric combination, use the highest grade/price + 5%
- If using COM or COL, pricing will be COM or COL + 5%.
- If both COM + COL are used in combination, use COL + 5%.

Product Features

- Screens are constructed from tubular metal that is welded to maximize the strength, precise measurements and overall longevity.
- Horizontal back provides easy ganging capabilities.
- Utilizes elastic webbing suspension that conforms to individual's lumbar curvatures for adaptive support.
- Upholstered screens can be specified in contrasting fabrics, vinyl, or leathers.
- All units are standard with 1" adjustable glides that allow for leveling
- Work side table on left facing side
- Specify side table finish color
- Height of work side table is 26"
- Size of work side table 14.75W x 16D

Notes

- Please consult customer service when specifying a table other than Bota to ensure adequacy of seat access
- When delete side screen option is specified, ganging brackets are installed on the lounge side. If the unit will be open specify the delete screen non-ganging option. Non-ganging option will not have side mounted ganging brackets

Options

Delete Side Screen

Delete Right Screen

- DRSG: Delete Right Side Screen for Ganging - Deduct \$500 (Ganging Hardware Installed)
- DRSN: Delete Right Side Screen for Non-Ganging - Deduct \$475 (Ganging Hardware Not Installed)

Power

- PDNIU-L: Node in Left Facing Seat Front; 1 Power/1 USB Charger - \$355
- PDNIU-R: Node in Right Facing Seat Front; 1 Power/1 USB Charger - \$355
- PDNIU-B: Node in Both Left and Right Facing Seat Front; 1 Power/1 USB Charger per pod - \$709
- Standard in White (Available in Silver and Black)

Bota

Shell - Single Seat
Low Back - Swivel Base

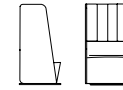

[Click here to view statement of line](#)

1 Model BOT0160SLS01

w" x d" x h"
33.75 x 29.25 x 53
Arm Height -
Seat Height 17.5
Inside Seat Depth 17
Inside Seat Width 29.5

COM	COL	1	2	3	4	5	6	7	8	9	10	11/L1	12	13/L2
6587	6696	6805	6914	7023	7132	7241	7350	7459	7568	7677	7786	7895	8004	8222

Upholstery Requirements
Fabric yds: 6 Leather Sq. Ft.: 108
Carton Weight: 160

2 Select Finish

[Click to view finishes](#)

N/A

NA

3 Combination Fabrics

[Click to view finishes](#)

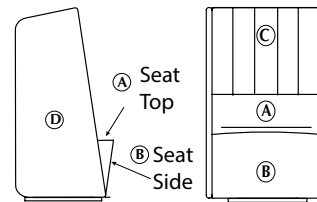

DARRAN is pleased to offer customers the design freedom of combination fabrics. When using fabric, vinyl or leather combinations, pricing/yardage requirements will be as follows:

- A Inside Back & Seat 1.5 yds
- B Lounge Exterior 3 yds
- C Privacy Screen Interior 1 yds
- D Side Screens, Lounge Exterior, Privacy Screens 5 yds

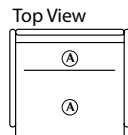

Node Power Placement Option

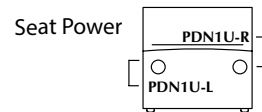

Table Power NA

Product Features

- Screens are constructed from tubular metal that is welded to maximize the strength, precise measurements and overall longevity.
- Horizontal back provides easy ganging capabilities.
- Utilizes elastic webbing suspension that conforms to individual's lumbar curvatures for adaptive support.
- Upholstered screens can be specified in contrasting fabrics, vinyl, or leathers.
- Swivel base

Notes

- Please consult customer service when specifying a table other than Bota to ensure adequacy of seat access

Power

- PDN1U-L: Node in Left Facing Seat Front; 1 Power/1 USB Charger - \$355
- PDN1U-R: Node in Right Facing Seat Front; 1 Power/1 USB Charger - \$355
- PDN1U-B: Node in Both Left and Right Facing Seat Front; 1 Power/1 USB Charger per pod - \$709
- Standard in White (Available in Silver and Black)

- When combining two materials of the same grade, pricing will be specified grade + 5%
- If combining two materials of different grades or leather/fabric combination, use the highest grade/price + 5%
- If using COM or COL, pricing will be COM or COL + 5%.
- If both COM + COL are used in combination, use COL + 5%.

Bota

Shell - Single Seat
High Back - Swivel Base

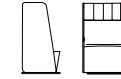

[Click here to view statement of line](#)

1 Model BOT0160SHS01

w" x d" x h"
33.75 x 29.25 x 53
Arm Height -
Seat Height 17.5
Inside Seat Depth 17
Inside Seat Width 29.5

COM	COL	1	2	3	4	5	6	7	8	9	10	11/L1	12	13/L2
6615	6743	6871	6999	7127	7255	7383	7511	7639	7767	7895	8023	8151	8279	8535

Upholstery Requirements
Fabric yds: 7 Leather Sq. Ft.: 126
Carton Weight: 165

2 Select Finish

[Click to view finishes](#)

N/A

NA

3 Combination Fabrics

[Click to view finishes](#)

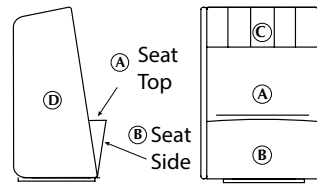

DARRAN is pleased to offer customers the design freedom of combination fabrics. When using fabric, vinyl or leather combinations, pricing/yardage requirements will be as follows:

- A Inside Back & Seat 1.5 yds
- B Lounge Exterior 3 yds
- C Privacy Screen Interior 1 yds
- D Side Screens, Lounge Exterior, Privacy Screens 5 yds

Top View

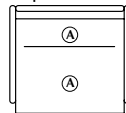

Node Power Placement Option

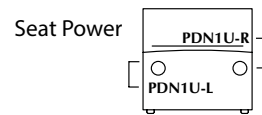

- When combining two materials of the same grade, pricing will be specified grade + 5%
- If combining two materials of different grades or leather/fabric combination, use the highest grade/price + 5%
- If using COM or COL, pricing will be COM or COL + 5%.
- If both COM + COL are used in combination, use COL + 5%.

Product Features

- Screens are constructed from tubular metal that is welded to maximize the strength, precise measurements and overall longevity.
- Horizontal back provides easy ganging capabilities.
- Utilizes elastic webbing suspension that conforms to individual's lumbar curvatures for adaptive support.
- Upholstered screens can be specified in contrasting fabrics, vinyl, or leathers.
- Swivel base

Notes

- Please consult customer service when specifying a table other than Bota to ensure adequacy of seat access

Power

- PDN1U-L: Node in Left Facing Seat Front; 1 Power/1 USB Charger - \$355
- PDN1U-R: Node in Right Facing Seat Front; 1 Power/1 USB Charger - \$355
- PDN1U-B: Node in Both Left and Right Facing Seat Front; 1 Power/1 USB Charger per pod - \$709
- Standard in White (Available in Silver and Black)

Bota

Shell - Double Seat
 Low Back - Side Screens & Privacy Screen

[Click here to view statement of line](#)

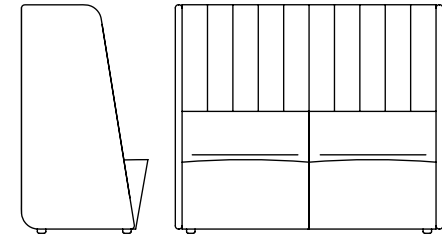

1 Model BOT0160DLN02

w" x d" x h"
 62 x 29.25 x 53
 Arm Height -
 Seat Height 17.5
 Inside Seat Depth 17
 Inside Seat Width 29.5

COM	COL	1	2	3	4	5	6	7	8	9	10	11/L1	12	13/L2
6630	6849	7068	7287	7506	7725	7944	8163	8382	8601	8820	9039	9258	9477	9915

Upholstery Requirements
 Fabric yds: 12 Leather Sq. Ft.: 216
 Carton Weight: 170

2 Select Finish

[Click to view finishes](#)

NA

3 Combination Fabrics

[Click to view finishes](#)

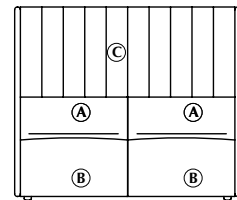
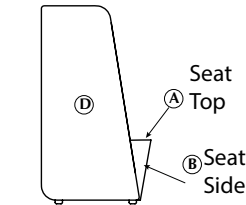

Seat Back Top

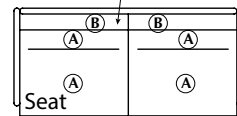

Node Power Placement Option

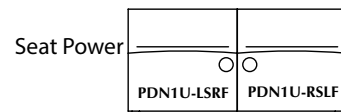

Table Power NA

DARRAN is pleased to offer customers the design freedom of combination fabrics. When using fabric, vinyl or leather combinations, pricing/yardage requirements will be as follows:

- A Inside Back & Seat 2 yds
- B Lounge Exterior 4 yds
- C Privacy Screen 2 yds
- D Side Screens, Lounge Exterior, Privacy Screens 6 yds

- When combining two materials of the same grade, pricing will be specified grade + 5%
- If combining two materials of different grades or leather/fabric combination, use the highest grade/price + 5%
- If using COM or COL, pricing will be COM or COL + 5%.
- If both COM + COL are used in combination, use COL + 5%.

Product Features

- Screens are constructed from tubular metal that is welded to maximize the strength, precise measurements and overall longevity.
- Horizontal back provides easy ganging capabilities.
- Utilizes elastic webbing suspension that conforms to individual's lumbar curvatures for adaptive support.
- Upholstered screens can be specified in contrasting fabrics, vinyl, or leathers.
- All units are standard with 1" adjustable glides that allow for leveling

Notes

- Please consult customer service when specifying a table other than Bota to ensure adequacy of seat access
- When delete side screen option is specified, ganging brackets are installed on the lounge side. If the unit will be open specify the delete screen non-ganging option. Non-ganging option will not have side mounted ganging brackets

Options

Delete Side Screen

Delete Left Screen

- DLSG: Delete Left Side Screen for Ganging - Deduct \$500 (Ganging Hardware Installed)
- DLSN: Delete Left Side Screen for Non-Ganging - Deduct \$475 (Ganging Hardware Not Installed)

Delete Right Screen

- DRSG: Delete Right Side Screen for Ganging - Deduct \$500 (Ganging Hardware Installed)
- DRSN: Delete Right Side Screen for Non-Ganging - Deduct \$475 (Ganging Hardware Not Installed)

Power

- PDN1U-LSRF: Node in Left Seat Right Facing Seat Front; 1 Power/1 USB Charger - \$355
- PDN1U-RSLF: Node in Right Seat Left Facing Seat Front; 1 Power/1 USB Charger - \$355
- PDN1U-BC: Node in Both Left and Right Facing Center Seat Front; 1 Power/1 USB Charger per pod - \$709
- Standard in White (Available in Silver and Black)

1/2" Compact Matte Laminate Tablet

- FFTD: 1/2" Compact Matte Laminate Tablet - \$622, Specify LAW Alaska or LNB Nero Finish
- Tablet is center mount only

Premium Finish Option (Standard White)

- Specify rear table bracket Metal Finish color - \$100 per unit
- Specify tablet Metal Finish color - \$100 per unit
- MFS: Silver, MFB: Black

Bota

Shell - Double Seat
High Back - Side Screens & Privacy Screen

[Click here to view statement of line](#)

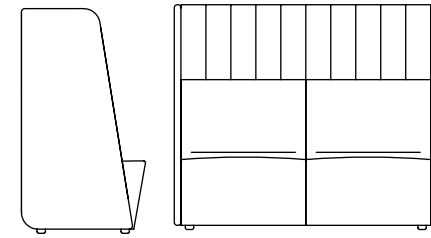

1 Model BOT0160DHN02

w" x d" x h"
62 x 29.25 x 53
Arm Height -
Seat Height 17.5
Inside Seat Depth 17
Inside Seat Width 29.5

COM	COL	1	2	3	4	5	6	7	8	9	10	11/L1	12	13/L2
6658	6895	7132	7369	7606	7843	8080	8317	8554	8791	9028	9265	9502	9739	10213

Upholstery Requirements
Fabric yds: 13 Leather Sq. Ft.: 234
Carton Weight: 175

2 Select Finish

[Click to view finishes](#)

NA

3 Combination Fabrics

[Click to view finishes](#)

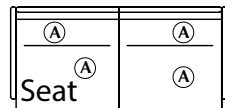
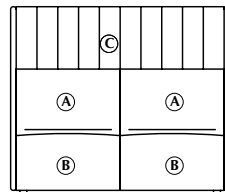
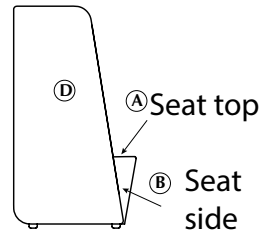

DARRAN is pleased to offer customers the design freedom of combination fabrics. When using fabric, vinyl or leather combinations, pricing/yardage requirements will be as follows:

- A Inside Back & Seat 2 yds
- B Lounge Exterior 5 yds
- C Privacy Screen 2 yds
- D Side Screens, Lounge Exterior, Privacy Screens 6 yds

- When combining two materials of the same grade, pricing will be specified grade + 5%
- If combining two materials of different grades or leather/fabric combination, use the highest grade/price + 5%
- If using COM or COL, pricing will be COM or COL + 5%.
- If both COM + COL are used in combination, use COL + 5%.

Node Power Placement Option

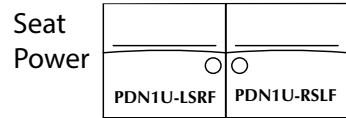

Table Power NA

Product Features

- Screens are constructed from tubular metal that is welded to maximize the strength, precise measurements and overall longevity.
- Horizontal back provides easy ganging capabilities.
- Utilizes elastic webbing suspension that conforms to individual's lumbar curvatures for adaptive support.
- Upholstered screens can be specified in contrasting fabrics, vinyl, or leathers.
- All units are standard with 1" adjustable glides that allow for leveling

Notes

- Please consult customer service when specifying a table other than Bota to ensure adequacy of seat access
- When delete side screen option is specified, ganging brackets are installed on the lounge side. If the unit will be open specify the delete screen non-ganging option. Non-ganging option will not have side mounted ganging brackets

Options

Delete Side Screen

Delete Left Screen

- DLSG: Delete Left Side Screen for Ganging - Deduct \$500 (Ganging Hardware Installed)
- DLSN: Delete Left Side Screen for Non-Ganging - Deduct \$475 (Ganging Hardware Not Installed)

Delete Right Screen

- DRSG: Delete Right Side Screen for Ganging - Deduct \$500 (Ganging Hardware Installed)
- DRSN: Delete Right Side Screen for Non-Ganging - Deduct \$475 (Ganging Hardware Not Installed)

Power

- PDN1U-LSRF: Node in Left Seat Right Facing Seat Front; 1 Power/1 USB Charger - \$355
- PDN1U-RSLF: Node in Right Seat Left Facing Seat Front; 1 Power/1 USB Charger - \$355
- PDN1U-BC: Node in Both Left and Right Facing Center Seat Front; 1 Power/1 USB Charger per pod - \$709
- Standard in White (Available in Silver and Black)

1/2" Compact Matte Laminate Tablet

- FFTD: 1/2" Compact Matte Laminate Tablet - \$622, Specify LAW Alaska or LNB Nero Finish
- Tablet is center mount only

Premium Finish Option (Standard White)

- Specify rear table bracket Metal Finish color - \$100 per unit
- Specify tablet Metal Finish color - \$100 per unit
- MFS: Silver, MFB: Black

Bota

Shell - Double Seat

Low Back - Side Screens, Privacy Screen & Roof

[Click here to view statement of line](#)

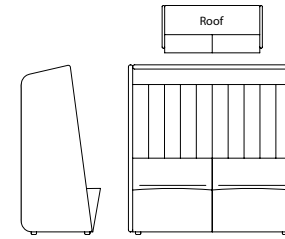

1 Model BOT0160DLR02

w" x d" x h"
62 x 29.25 x 63
Arm Height -
Seat Height 17.5
Inside Seat Depth 17
Inside Seat Width 29.5

COM	COL	1	2	3	4	5	6	7	8	9	10	11/L1	12	13/L2
8201	8493	8785	9077	9369	9661	9953	10245	10537	10829	11121	11413	11705	11997	12581

Upholstery Requirements
Fabric yds: 16 Leather Sq. Ft.: 288
Carton Weight: 185

2 Select Finish

[Click to view finishes](#)

NA

3 Combination Fabrics

[Click to view finishes](#)

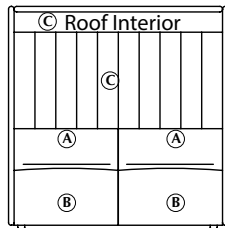
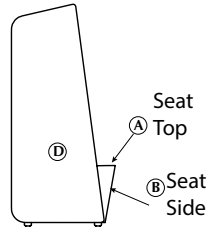
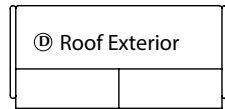

Node Power Placement Option

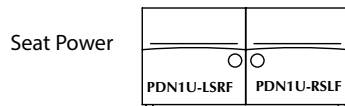

Table Power NA

DARRAN is pleased to offer customers the design freedom of combination fabrics. When using fabric, vinyl or leather combinations, pricing/yardage requirements will be as follows:

- A Inside Back & Seat 2 yds
- B Lounge Exterior 4 yds
- C Privacy Screen & Roof Interior 4 yds
- D Side Screens, Lounge Exterior, Roof Exterior 8 yds

- When combining two materials of the same grade, pricing will be specified grade + 5%
- If combining two materials of different grades or leather/fabric combination, use the highest grade/price + 5%
- If using COM or COL, pricing will be COM or COL + 5%.
- If both COM + COL are used in combination, use COL + 5%.

Product Features

- Screens are constructed from tubular metal that is welded to maximize the strength, precise measurements and overall longevity.
- Horizontal back provides easy ganging capabilities.
- Utilizes elastic webbing suspension that conforms to individual's lumbar curvatures for adaptive support.
- Upholstered screens & roof can be specified in contrasting fabrics, vinyl, or leathers.
- All units are standard with 1" adjustable glides that allow for leveling

Notes

- Please consult customer service when specifying a table other than Bota to ensure adequacy of seat access

Options

Power

- PDN1U-LSRF: Node in Left Seat Right Facing Seat Front; 1 Power/1 USB Charger - \$355
- PDN1U-RSLF: Node in Right Seat Left Facing Seat Front; 1 Power/1 USB Charger - \$355
- PDN1U-BC: Node in Both Left and Right Facing Center Seat Front; 1 Power/1 USB Charger per pod - \$709
- Standard in White (Available in Silver and Black)

1/2" Compact Matte Laminate Tablet

- FFTD: 1/2" Compact Matte Laminate Tablet - \$622, Specify LAW Alaska or LNB Nero Finish

- Tablet is center mount only

Premium Finish Option (Standard White)

- Specify rear table bracket Metal Finish color - \$100 per unit
- Specify tablet Metal Finish color - \$100 per unit
- MFS: Silver, MFB: Black

Bota

90 Deg. Circlet - Single Seat Low Back
 90 Degree Back Inside Radius - Low Back

[Click here to view statement of line](#)

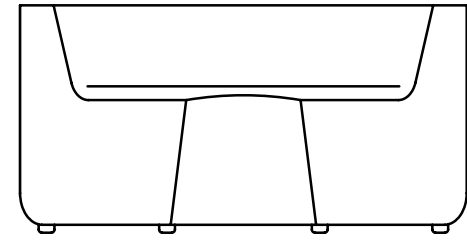

1 Model BOT0160LCS90

w" x d" x h"
 55.75 x 28.5 x 28.25
 Arm Height -
 Seat Height 17.5
 Inside Seat Depth 17
 Inside Seat Width 29.5

COM	COL	1	2	3	4	5	6	7	8	9	10	11/L1	12	13/L2
3202	3311	3420	3529	3638	3747	3856	3965	4074	4183	4292	4401	4510	4619	4837

Upholstery Requirements
 Fabric yds: 6 Leather Sq. Ft.: 108
 Carton Weight: 55

2 Select Finish

[Click to view finishes](#)

NA

3 Combination Fabrics

[Click to view finishes](#)

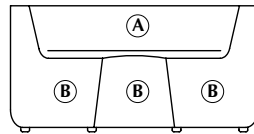

DARRAN is pleased to offer customers the design freedom of combination fabrics. When using fabric, vinyl or leather combinations, pricing/yardage requirements will be as follows:

A Inside Back & Seat 2 yds
 B Lounge Exterior 6 yds

Seat Back Top

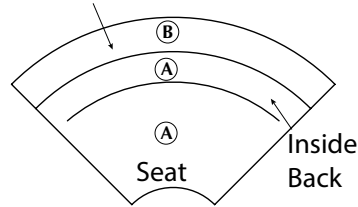

- When combining two materials of the same grade, pricing will be specified grade + 5%
- If combining two materials of different grades or leather/fabric combination, use the highest grade/price + 5%
- If using COM or COL, pricing will be COM or COL + 5%.
- If both COM + COL are used in combination, use COL + 5%.

Node Power Placement Option

Table Power

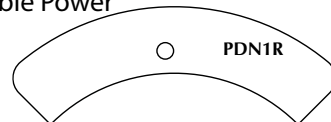

Seat Power N/A

Product Features

- Horizontal back provides easy ganging capabilities.
- Utilizes elastic webbing suspension that conforms to individual's lumbar curvatures for adaptive support.
- All units are standard with 1" adjustable glides that allow for leveling

Options

Ganging Device

- GDEV-L: Left Facing Ganging Device - \$20
- GDEV-R: Right Facing Ganging Device - \$20
- GDEV-C: Center Ganging Device - \$40

Power

- PDN1R- Node in Rear Mount Table Top; 1 Power/1 USB Charger - \$409
- Standard in White (Available in Silver and Black)

1/2" Compact Matte Laminate Rear Table

- Matte Laminate RTD55: Rear Work Table - \$1,423

- Rear table available on units that gang providing stability
- Rear table is mounted at 28.5"

Premium Finish Option (Standard White)

- Specify rear table bracket Metal Finish color - \$100 per unit
- MFS: Silver, MFB: Black

Bota

90 Deg. Circlet - Single Seat Low Back With Privacy Screen
 90 Degree Back Inside Radius - Low Back - 10.5" Privacy Screen

[Click here to view statement of line](#)

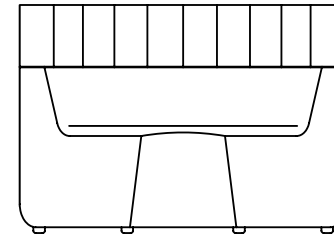

1 Model BOT0160LCL90

w" x d" x h"
 55.75 x 28.5 x 39
 Arm Height -
 Seat Height 17.5
 Inside Seat Depth 17
 Inside Seat Width 29.5

COM	COL	1	2	3	4	5	6	7	8	9	10	11/L1	12	13/L2
4283	4429	4575	4721	4867	5013	5159	5305	5451	5597	5743	5889	6035	6181	6473

Upholstery Requirements
 Fabric yds: 8 Leather Sq. Ft.: 144
 Carton Weight: 65

2 Select Finish

[Click to view finishes](#)

NA

3 Combination Fabrics

[Click to view finishes](#)

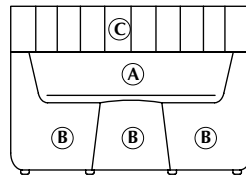

DARRAN is pleased to offer customers the design freedom of combination fabrics. When using fabric, vinyl or leather combinations, pricing/yardage requirements will be as follows:

- A Inside Back & Seat 2 yds
- B Lounge Exterior 6 yds
- C Privacy Screen 2.5 yds

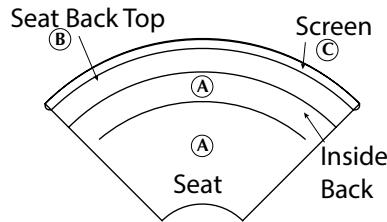

- When combining two materials of the same grade, pricing will be specified grade + 5%
- If combining two materials of different grades or leather/fabric combination, use the highest grade/price + 5%
- If using COM or COL, pricing will be COM or COL + 5%.
- If both COM + COL are used in combination, use COL + 5%.

Node Power Placement Option

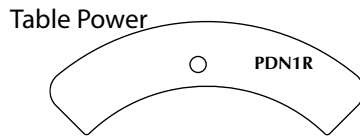

Seat Power N/A

Product Features

- Upholstered screens can be specified in contrasting fabrics, vinyl, or leathers.
- All units are standard with 1" adjustable glides that allow for leveling

Options

Ganging Device

- GDEV-L: Left Facing Ganging Device - \$20
- GDEV-R: Right Facing Ganging Device - \$20
- GDEV-C: Center Ganging Device - \$40

Power

- PDN1R- Node in Rear Mount Table Top; 1 Power/1 USB Charger - \$409
- Standard in White (Available in Silver and Black)

1/2" Compact Matte Laminate Rear Table

- Matte Laminate RTD55: Rear Work Table - \$1,423

- Rear table available on units that gang providing stability
- Rear table is mounted at 28.5"

Premium Finish Option (Standard White)

- Specify rear table bracket Metal Finish color - \$100 per unit
- MFS: Silver, MFB: Black

Bota

90 Deg. Circlet - Single Seat Low Back With Privacy Screen
 90 Degree Back Inside Radius - Low Back - 24.75" Privacy Screen

[Click here to view statement of line](#)

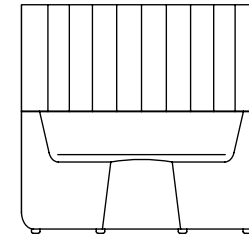

1 Model BOT0160LCH90

w" x d" x h"
 55.75 x 28.5 x 53.25
 Arm Height -
 Seat Height 17.5
 Inside Seat Depth 17
 Inside Seat Width 29.5

COM	COL	1	2	3	4	5	6	7	8	9	10	11/L1	12	13/L2
4942	5124	5306	5488	5670	5852	6034	6216	6398	6580	6762	6944	7126	7308	7672

Upholstery Requirements
 Fabric yds: 10 Leather Sq. Ft.: 180
 Carton Weight: 70

2 Select Finish

[Click to view finishes](#)

NA

3 Combination Fabrics

[Click to view finishes](#)

DARRAN is pleased to offer customers the design freedom of combination fabrics. When using fabric, vinyl or leather combinations, pricing/yardage requirements will be as follows:

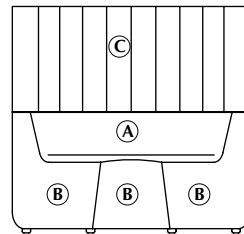

A Inside Back & Seat 2 yds
 B Lounge Exterior 6 yds
 C Privacy Screen 5 yds

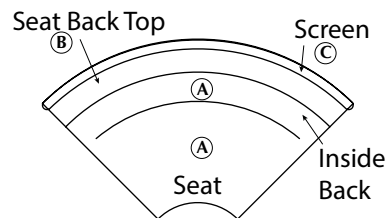

- When combining two materials of the same grade, pricing will be specified grade + 5%
- If combining two materials of different grades or leather/fabric combination, use the highest grade/price + 5%
- If using COM or COL, pricing will be COM or COL + 5%.
- If both COM + COL are used in combination, use COL + 5%.

Node Power Placement Option

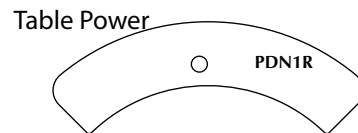

Seat Power N/A

Product Features

- Horizontal back provides easy ganging capabilities.
- Utilizes elastic webbing suspension that conforms to individual's lumbar curvatures for adaptive support.
- Upholstered Privacy Screen
- Upholstered screens can be specified in contrasting fabrics, vinyl, or leathers.
- All units are standard with 1" adjustable glides that allow for leveling

Options

Ganging Device

- GDEV-L: Left Facing Ganging Device - \$20
- GDEV-R: Right Facing Ganging Device - \$20
- GDEV-C: Center Ganging Device - \$40

Power

- PDN1R- Node in Rear Mount Table Top; 1 Power/1 USB Charger - \$409
- Standard in White (Available in Silver and Black)

1/2" Compact Matte Laminate Rear Table

- Matte Laminate RTD55: Rear Work Table - \$1,423

- Rear table available on units that gang providing stability
- Rear table is mounted at 28.5"

Premium Finish Option (Standard White)

- Specify rear table bracket Metal Finish color - \$100 per unit
- MFS: Silver, MFB: Black

Bota

90 Deg. Circlet - Single Seat High Back
 90 Degree Back Inside Radius - High Back

[Click here to view statement of line](#)

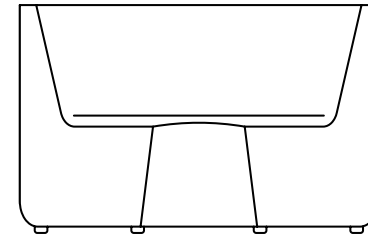

1 Model BOT0160HCS90

w" x d" x h"
 55.75 x 28.5 x 35.5
 Arm Height -
 Seat Height 17.5
 Inside Seat Depth 17
 Inside Seat Width 29.5

COM	COL	1	2	3	4	5	6	7	8	9	10	11/L1	12	13/L2
3683	3802	3921	4040	4159	4278	4397	4516	4635	4754	4873	4992	5111	5230	5468

Upholstery Requirements
 Fabric yds: 6.5 Leather Sq. Ft.: 117
 Carton Weight: 60

2 Select Finish

[Click to view finishes](#)

NA

3 Combination Fabrics

[Click to view finishes](#)

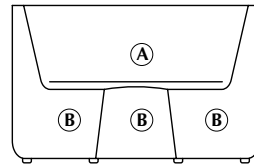

DARRAN is pleased to offer customers the design freedom of combination fabrics. When using fabric, vinyl or leather combinations, pricing/yardage requirements will be as follows:

A Inside Back & Seat 3 yds
 B Lounge Exterior 6 yds

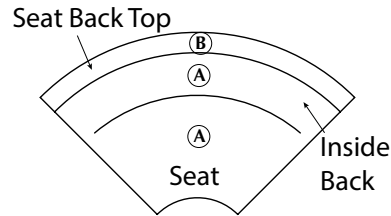

- When combining two materials of the same grade, pricing will be specified grade + 5%
- If combining two materials of different grades or leather/fabric combination, use the highest grade/price + 5%
- If using COM or COL, pricing will be COM or COL + 5%.
- If both COM + COL are used in combination, use COL + 5%.

Node Power Placement Option

Table Power

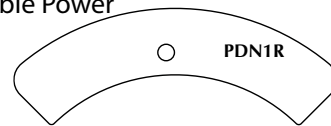

Seat Power N/A

Product Features

- Horizontal back provides easy ganging capabilities.
- Utilizes elastic webbing suspension that conforms to individual's lumbar curvatures for adaptive support.
- All units are standard with 1" adjustable glides that allow for leveling

Options

Ganging Device

- GDEV-L: Left Facing Ganging Device - \$20
- GDEV-R: Right Facing Ganging Device - \$20
- GDEV-C: Center Ganging Device - \$40

Power

- PDN1R- Node in Rear Mount Table Top; 1 Power/1 USB Charger - \$409
- Standard in White (Available in Silver and Black)

1/2" Compact Matte Laminate Rear Table

- Matte Laminate RTD55: Rear Work Table - \$1,423

- Rear table available on units that gang providing stability
- Rear table is mounted at 35.5"

Premium Finish Option (Standard White)

- Specify rear table bracket Metal Finish color - \$100 per unit
- MFS: Silver, MFB: Black

Bota

90 Deg. Circlet - Single Seat High Back With Privacy Screen
 90 Degree Back Inside Radius - High Back - 10.5" Privacy Screen

[Click here to view statement of line](#)

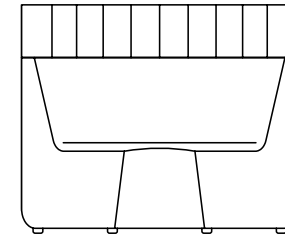

1 Model BOT0160HCL90

w" x d" x h"
 55.75 x 28.5 x 46
 Arm Height -
 Seat Height 17.5
 Inside Seat Depth 17
 Inside Seat Width 29.5

COM	COL	1	2	3	4	5	6	7	8	9	10	11/L1	12	13/L2
4746	4910	5074	5238	5402	5566	5730	5894	6058	6222	6386	6550	6714	6878	7206

Upholstery Requirements
 Fabric yds: 9 Leather Sq. Ft.: 162
 Carton Weight: 70

2 Select Finish

[Click to view finishes](#)

NA

3 Combination Fabrics

[Click to view finishes](#)

DARRAN is pleased to offer customers the design freedom of combination fabrics. When using fabric, vinyl or leather combinations, pricing/yardage requirements will be as follows:

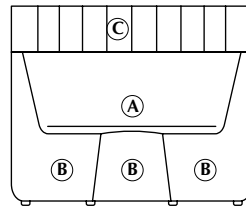

A Inside Back & Seat 3 yds
 B Lounge Exterior 6 yds
 C Privacy Screen 2.5 yds

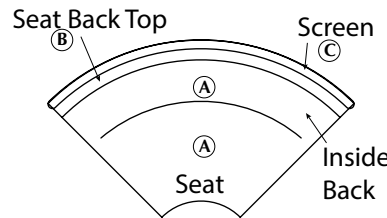

- When combining two materials of the same grade, pricing will be specified grade + 5%
- If combining two materials of different grades or leather/fabric combination, use the highest grade/price + 5%
- If using COM or COL, pricing will be COM or COL + 5%.
- If both COM + COL are used in combination, use COL + 5%.

Node Power Placement Option

Table Power

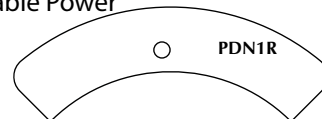

Seat Power N/A

Product Features

- Horizontal back provides easy ganging capabilities.
- Utilizes elastic webbing suspension that conforms to individual's lumbar curvatures for adaptive support.
- Upholstered Privacy Screen
- Upholstered screens can be specified in contrasting fabrics, vinyl, or leathers.
- All units are standard with 1" adjustable glides that allow for leveling

Options

Ganging Device

- GDEV-L: Left Facing Ganging Device - \$20
- GDEV-R: Right Facing Ganging Device - \$20
- GDEV-C: Center Ganging Device - \$40

Power

- PDN1R- Node in Rear Mount Table Top; 1 Power/1 USB Charger - \$409
- Standard in White (Available in Silver and Black)

1/2" Compact Matte Laminate Rear Table

- Matte Laminate RTD55: Rear Work Table - \$1,423

- Rear table available on units that gang providing stability
- Rear table is mounted at 35.5"

Premium Finish Option (Standard White)

- Specify rear table bracket Metal Finish color - \$100 per unit
- MFS: Silver, MFB: Black

Bota

90 Deg. Circlet - Single Seat High Back With Privacy Screen
 90 Degree Back Inside Radius - High Back - 17.5" Privacy Screen

[Click here to view statement of line](#)

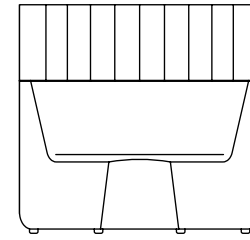

1 Model BOT0160HCH90

w" x d" x h"
 55.75 x 28.5 x 53
 Arm Height -
 Seat Height 17.5
 Inside Seat Depth 17
 Inside Seat Width 29.5

COM	COL	1	2	3	4	5	6	7	8	9	10	11/L1	12	13/L2
4947	5157	5367	5577	5787	5997	6207	6417	6627	6837	7047	7257	7467	7677	8097

Upholstery Requirements
 Fabric yds: 11.5 Leather Sq. Ft.: 207
 Carton Weight: 75

2 Select Finish

[Click to view finishes](#)

NA

3 Combination Fabrics

[Click to view finishes](#)

DARRAN is pleased to offer customers the design freedom of combination fabrics. When using fabric, vinyl or leather combinations, pricing/yardage requirements will be as follows:

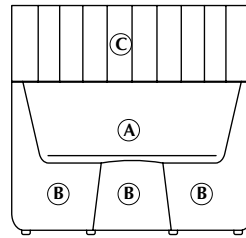

A Inside Back & Seat 3 yds
 B Lounge Exterior 6 yds
 C Privacy Screen 5 yds

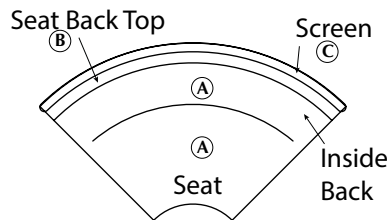

Node Power Placement Option

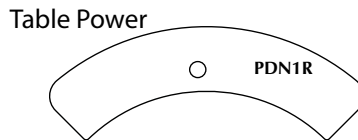

Seat Power N/A

- When combining two materials of the same grade, pricing will be specified grade + 5%
- If combining two materials of different grades or leather/fabric combination, use the highest grade/price + 5%
- If using COM or COL, pricing will be COM or COL + 5%.
- If both COM + COL are used in combination, use COL + 5%.

Product Features

- Horizontal back provides easy ganging capabilities.
- Utilizes elastic webbing suspension that conforms to individual's lumbar curvatures for adaptive support.
- Upholstered Privacy Screen
- Upholstered screens can be specified in contrasting fabrics, vinyl, or leathers.
- All units are standard with 1" adjustable glides that allow for leveling

Options

Ganging Device

- GDEV-L: Left Facing Ganging Device - \$20
- GDEV-R: Right Facing Ganging Device - \$20
- GDEV-C: Center Ganging Device - \$40

Power

- PDN1R- Node in Rear Mount Table Top; 1 Power/1 USB Charger - \$409
- Standard in White (Available in Silver and Black)

1/2" Compact Matte Laminate Rear Table

- Matte Laminate RTD55: Rear Work Table - \$1,423

- Rear table available on units that gang providing stability
- Rear table is mounted at 35.5"

Premium Finish Option (Standard White)

- Specify rear table bracket Metal Finish color - \$100 per unit
- MFS: Silver, MFB: Black

Bota

60 Deg. Circlet - Double Seat Low Back
 60 Degree Back Inside Radius - Low Back

[Click here to view statement of line](#)

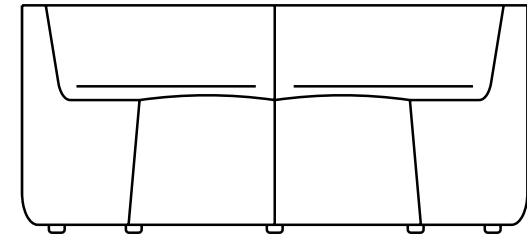

1 Model BOT0160LCS60

w" x d" x h"
 63 x 28.5 x 28.25
 Arm Height -
 Seat Height 17.5
 Inside Seat Depth 17
 Inside Seat Width 29.5

COM	COL	1	2	3	4	5	6	7	8	9	10	11/L1	12	13/L2
3522	3631	3740	3849	3958	4067	4176	4285	4394	4503	4612	4721	4830	4939	5157

Upholstery Requirements
 Fabric yds: 6 Leather Sq. Ft.: 108
 Carton Weight: 89

2 Select Finish

[Click to view finishes](#)

NA

3 Combination Fabrics

[Click to view finishes](#)

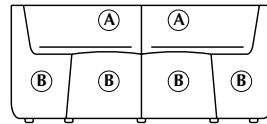

DARRAN is pleased to offer customers the design freedom of combination fabrics. When using fabric, vinyl or leather combinations, pricing/yardage requirements will be as follows:

A Inside Back & Seat 2 yds
 B Lounge Exterior 6 yds

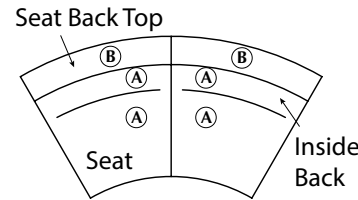

- When combining two materials of the same grade, pricing will be specified grade + 5%
- If combining two materials of different grades or leather/fabric combination, use the highest grade/price + 5%
- If using COM or COL, pricing will be COM or COL + 5%.
- If both COM + COL are used in combination, use COL + 5%.

Node Power Placement Option

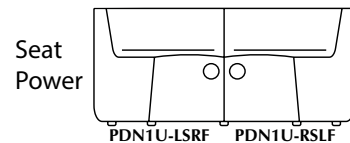
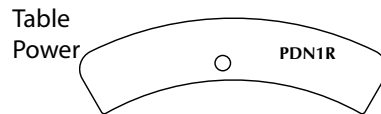

Product Features

- Horizontal back provides easy ganging capabilities.
- Utilizes elastic webbing suspension that conforms to individual's lumbar curvatures for adaptive support.
- All units are standard with 1" adjustable glides that allow for leveling

Options

Ganging Device

- GDEV-L: Left Facing Ganging Device - \$20
- GDEV-R: Right Facing Ganging Device - \$20
- GDEV-C: Center Ganging Device - \$40

Power

- PDN1U-LSRF: Node in Left Seat Right Facing Seat Front; 1 Power/1 USB Charger - \$355
- PDN1U-RSLF: Node in Right Seat Left Facing Seat Front; 1 Power/1 USB Charger - \$355
- PDN1U-BC: Node in Both Left and Right Facing Center Seat Front; 1 Power/1 USB Charger per pod - \$709
- PDN1R: Node in Rear Mount Table Top; 1 Power/1 USB Charger - \$409
- Standard in White (Available in Silver and Black)

1/2" Compact Matte Laminate Rear Table

- Matte Laminate RTD63: Rear Work Table - \$1,472

- Rear table available on units that gang providing stability
- Rear table is mounted at 28.5"

1/2" Compact Matte Laminate Tablet

- FFTD: 1/2" Compact Matte Laminate Tablet - \$622

- Tablet is center mount only

Premium Finish Option (Standard White)

- Specify rear table bracket Metal Finish color - \$100 per unit
- Specify tablet Metal Finish color - \$100 per unit
- MFS: Silver, MFB: Black

Bota

60 Deg. Circlet - Double Seat Low Back With Privacy Screen
 60 Degree Back Inside Radius - Low Back - 10.5" Privacy Screen

[Click here to view statement of line](#)

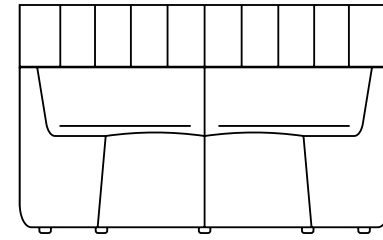

1 Model BOT0160LCL60

w" x d" x h"
 63 x 28.5 x 39
 Arm Height -
 Seat Height 17.5
 Inside Seat Depth 17
 Inside Seat Width 29.5

COM	COL	1	2	3	4	5	6	7	8	9	10	11/L1	12	13/L2
4592	4738	4884	5030	5176	5322	5468	5614	5760	5906	6052	6198	6344	6490	6782

Upholstery Requirements
 Fabric yds: 8 Leather Sq. Ft.: 144
 Carton Weight: 99

2 Select Finish

[Click to view finishes](#)

NA

3 Combination Fabrics

[Click to view finishes](#)

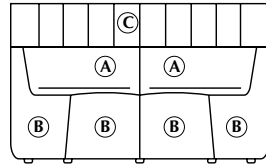

DARRAN is pleased to offer customers the design freedom of combination fabrics. When using fabric, vinyl or leather combinations, pricing/yardage requirements will be as follows:

- A Inside Back & Seat 2 yds
- B Lounge Exterior 6 yds
- C Privacy Screen 2.5 yds

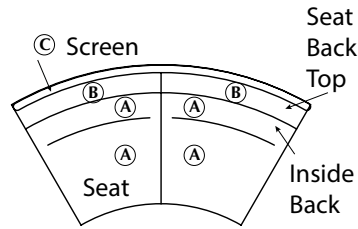

- When combining two materials of the same grade, pricing will be specified grade + 5%
- If combining two materials of different grades or leather/fabric combination, use the highest grade/price + 5%
- If using COM or COL, pricing will be COM or COL + 5%.
- If both COM + COL are used in combination, use COL + 5%.

Node Power Placement Option

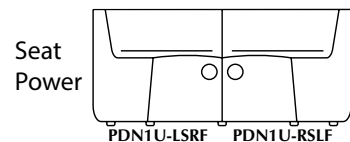
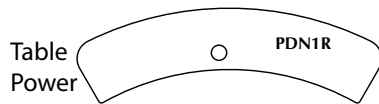

Product Features

- Horizontal back provides easy ganging capabilities.
- Utilizes elastic webbing suspension that conforms to individual's lumbar curvatures for adaptive support.
- Upholstered Privacy Screen
- Upholstered screens can be specified in contrasting fabrics, vinyl, or leathers.
- All units are standard with 1" adjustable glides that allow for leveling

Options

Ganging Device

- GDEV-L: Left Facing Ganging Device - \$20
- GDEV-R: Right Facing Ganging Device - \$20
- GDEV-C: Center Ganging Device - \$40

Power

- PDN1U-LSRF: Node in Left Seat Right Facing Seat Front; 1 Power/1 USB Charger - \$355
- PDN1U-RSLF: Node in Right Seat Left Facing Seat Front; 1 Power/1 USB Charger - \$355
- PDN1U-BC: Node in Both Left and Right Facing Center Seat Front; 1 Power/1 USB Charger per pod - \$709
- PDN1R: Node in Rear Mount Table Top; 1 Power/1 USB Charger - \$409
- Standard in White (Available in Silver and Black)

1/2" Compact Matte Laminate Rear Table

- Matte Laminate RTD63: Rear Work Table - \$1,472
- Rear table available on units that gang providing stability
- Rear table is mounted at 28.5"

1/2" Compact Matte Laminate Tablet

- FFTD: 1/2" Compact Matte Laminate Tablet - \$622

- Tablet is center mount only

Premium Finish Option (Standard White)

- Specify rear table bracket Metal Finish color - \$100 per unit
- Specify tablet Metal Finish color - \$100 per unit
- MFS: Silver, MFB: Black

Bota

60 Deg. Circlet - Double Seat Low Back With Privacy Screen
 60 Degree Back Inside Radius - Low Back - 24.75" Privacy Screen

[Click here to view statement of line](#)

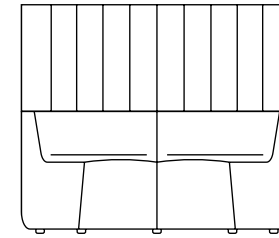

1 Model BOT0160LCH60

w" x d" x h"
 63 x 28.5 x 53.25
 Arm Height -
 Seat Height 17.5
 Inside Seat Depth 17
 Inside Seat Width 29.5

COM	COL	1	2	3	4	5	6	7	8	9	10	11/L1	12	13/L2
5333	5515	5697	5879	6061	6243	6425	6607	6789	6971	7153	7335	7517	7699	8063

Upholstery Requirements
 Fabric yds: 10 Leather Sq. Ft.: 180
 Carton Weight: 119

2 Select Finish

[Click to view finishes](#)

NA

3 Combination Fabrics

[Click to view finishes](#)

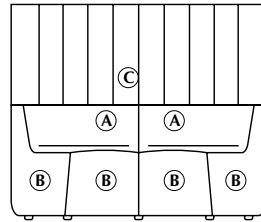

DARRAN is pleased to offer customers the design freedom of combination fabrics. When using fabric, vinyl or leather combinations, pricing/yardage requirements will be as follows:

A Inside Back & Seat 2 yds
 B Lounge Exterior 6 yds
 C Privacy Screen 5 yds

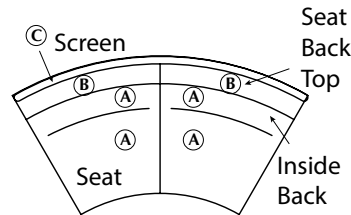

- When combining two materials of the same grade, pricing will be specified grade + 5%
- If combining two materials of different grades or leather/fabric combination, use the highest grade/price + 5%
- If using COM or COL, pricing will be COM or COL + 5%.
- If both COM + COL are used in combination, use COL + 5%.

Node Power Placement Option

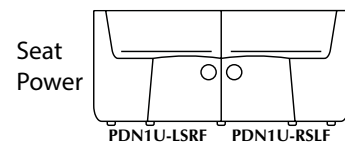
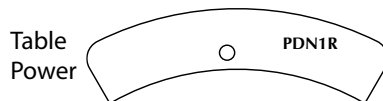

Product Features

- Horizontal back provides easy ganging capabilities.
- Utilizes elastic webbing suspension that conforms to individual's lumbar curvatures for adaptive support.
- Upholstered Privacy Screen
- Upholstered screens can be specified in contrasting fabrics, vinyl, or leathers.
- All units are standard with 1" adjustable glides that allow for leveling

Options

Ganging Device

- GDEV-L: Left Facing Ganging Device - \$20
- GDEV-R: Right Facing Ganging Device - \$20
- GDEV-C: Center Ganging Device - \$40

Power

- PDN1U-LSRF: Node in Left Seat Right Facing Seat Front; 1 Power/1 USB Charger - \$355
- PDN1U-RSLF: Node in Right Seat Left Facing Seat Front; 1 Power/1 USB Charger - \$355
- PDN1U-BC: Node in Both Left and Right Facing Center Seat Front; 1 Power/1 USB Charger per pod - \$709
- PDN1R: Node in Rear Mount Table Top; 1 Power/1 USB Charger - \$409
- Standard in White (Available in Silver and Black)

1/2" Compact Matte Laminate Rear Table

- Matte Laminate RTD63: Rear Work Table - \$1,472

- Rear table available on units that gang providing stability
- Rear table is mounted at 28.5"

1/2" Compact Matte Laminate Tablet

- FFD: 1/2" Compact Matte Laminate Tablet - \$622

- Tablet is center mount only

Premium Finish Option (Standard White)

- Specify rear table bracket Metal Finish color - \$100 per unit
- Specify tablet Metal Finish color - \$100 per unit
- MFS: Silver, MFB: Black

Bota

60 Deg. Circlet - Double Seat High Back
 60 Degree Back Inside Radius - High Back

[Click here to view statement of line](#)

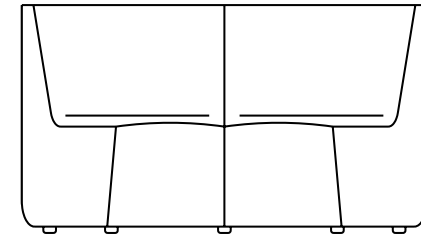

1 Model

BOT0160HCS60

w" x d" x h"
 63 x 28.5 x 35.5
 Arm Height -
 Seat Height 17.5
 Inside Seat Depth 17
 Inside Seat Width 29.5

COM	COL	1	2	3	4	5	6	7	8	9	10	11/L1	12	13/L2
4001	4120	4239	4358	4477	4596	4715	4834	4953	5072	5191	5310	5429	5548	5786

Upholstery Requirements
 Fabric yds: 6.5 Leather Sq. Ft.: 117
 Carton Weight: 94

2 Select Finish

[Click to view finishes](#)

NA

3 Combination Fabrics

[Click to view finishes](#)

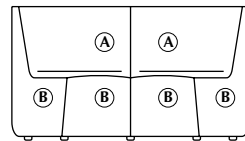

Seat Back Top

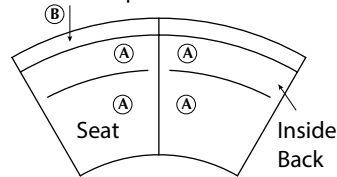

Node Power Placement Option

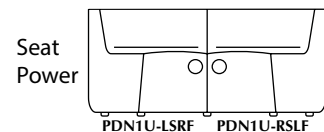
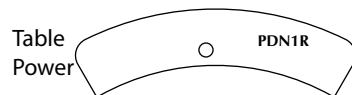

DARRAN is pleased to offer customers the design freedom of combination fabrics. When using fabric, vinyl or leather combinations, pricing/yardage requirements will be as follows:

A Inside Back & Seat 3 yds
 B Lounge Exterior 6 yds

- When combining two materials of the same grade, pricing will be specified grade + 5%
- If combining two materials of different grades or leather/fabric combination, use the highest grade/price + 5%
- If using COM or COL, pricing will be COM or COL + 5%.
- If both COM + COL are used in combination, use COL + 5%.

Product Features

- Horizontal back provides easy ganging capabilities.
- Utilizes elastic webbing suspension that conforms to individual's lumbar curvatures for adaptive support.
- All units are standard with 1" adjustable glides that allow for leveling

Options

Ganging Device

- GDEV-L: Left Facing Ganging Device - \$20
- GDEV-R: Right Facing Ganging Device - \$20
- GDEV-C: Center Ganging Device - \$40

Power

- PDN1U-LSRF: Node in Left Seat Right Facing Seat Front; 1 Power/1 USB Charger - \$355
- PDN1U-RSLF: Node in Right Seat Left Facing Seat Front; 1 Power/1 USB Charger - \$355
- PDN1U-BC: Node in Both Left and Right Facing Center Seat Front; 1 Power/1 USB Charger per pod - \$709
- PDN1R: Node in Rear Mount Table Top; 1 Power/1 USB Charger - \$409
- Standard in White (Available in Silver and Black)

1/2" Compact Matte Laminate Rear Table

- Matte Laminate RTD63: Rear Work Table - \$1,472
- Rear table available on units that gang providing stability
- Rear table is mounted at 35.5"

1/2" Compact Matte Laminate Tablet

- FFD: 1/2" Compact Matte Laminate Tablet - \$622

- Tablet is center mount only

Premium Finish Option (Standard White)

- Specify rear table bracket Metal Finish color - \$100 per unit
- Specify tablet Metal Finish color - \$100 per unit
- MFS: Silver, MFB: Black

Bota

60 Deg. Circlet - Double Seat High Back With Privacy Screen
 60 Degree Back Inside Radius - High Back - 10.5" Privacy Screen

[Click here to view statement of line](#)

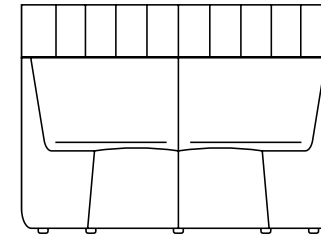

1 Model BOT0160HCL60

w" x d" x h"
 63 x 28.5 x 46
 Arm Height -
 Seat Height 17.5
 Inside Seat Depth 17
 Inside Seat Width 29.5

COM	COL	1	2	3	4	5	6	7	8	9	10	11/L1	12	13/L2
5094	5258	5422	5586	5750	5914	6078	6242	6406	6570	6734	6898	7062	7226	7554

Upholstery Requirements
 Fabric yds: 9 Leather Sq. Ft.: 162
 Carton Weight: 114

2 Select Finish

[Click to view finishes](#)

NA

3 Combination Fabrics

[Click to view finishes](#)

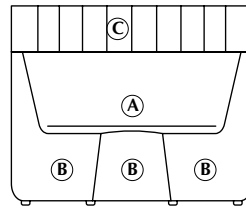

DARRAN is pleased to offer customers the design freedom of combination fabrics. When using fabric, vinyl or leather combinations, pricing/yardage requirements will be as follows:

- A Inside Back & Seat 3 yds
- B Lounge Exterior 6 yds
- C Privacy Screen 2.5 yds

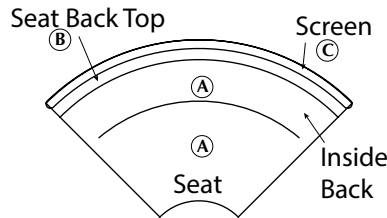

- When combining two materials of the same grade, pricing will be specified grade + 5%
- If combining two materials of different grades or leather/fabric combination, use the highest grade/price + 5%
- If using COM or COL, pricing will be COM or COL + 5%.
- If both COM + COL are used in combination, use COL + 5%.

Node Power Placement Option

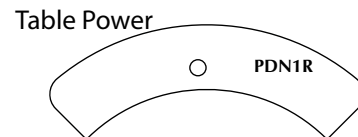

Seat Power N/A

Product Features

- Horizontal back provides easy ganging capabilities.
- Utilizes elastic webbing suspension that conforms to individual's lumbar curvatures for adaptive support.
- Upholstered Privacy Screen
- Upholstered screens can be specified in contrasting fabrics, vinyl, or leathers.
- All units are standard with 1" adjustable glides that allow for leveling

Options

Ganging Device

- GDEV-L: Left Facing Ganging Device - \$20
- GDEV-R: Right Facing Ganging Device - \$20
- GDEV-C: Center Ganging Device - \$40

Power

- PDN1U-LSRF: Node in Left Seat Right Facing Seat Front; 1 Power/1 USB Charger - \$355
- PDN1U-RSLF: Node in Right Seat Left Facing Seat Front; 1 Power/1 USB Charger - \$355
- PDN1U-BC: Node in Both Left and Right Facing Center Seat Front; 1 Power/1 USB Charger per pod - \$709
- PDN1R- Node in Rear Mount Table Top; 1 Power/1 USB Charger - \$409
- Standard in White (Available in Silver and Black)

1/2" Compact Matte Laminate Rear Table

- Matte Laminate RTD63: Rear Work Table - \$1,472
- Rear table available on units that gang providing stability
- Rear table is mounted at 35.5"

1/2" Compact Matte Laminate Tablet

- FFTD: 1/2" Compact Matte Laminate Tablet - \$622

- Tablet is center mount only

Premium Finish Option (Standard White)

- Specify rear table bracket Metal Finish color - \$100 per unit
- Specify tablet Metal Finish color - \$100 per unit
- MFS: Silver, MFB: Black

Bota

60 Deg. Circlet - Double Seat High Back With Privacy Screen
 60 Degree Back Inside Radius - High Back - 17.5" Privacy Screen

[Click here to view statement of line](#)

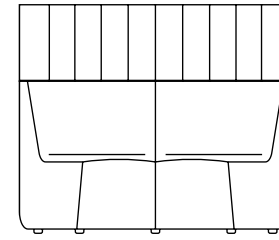

1 Model BOT0160HCH60

w" x d" x h"
 63 x 28.5 x 53
 Arm Height -
 Seat Height 17.5
 Inside Seat Depth 17
 Inside Seat Width 29.5

COM	COL	1	2	3	4	5	6	7	8	9	10	11/L1	12	13/L2
5487	5697	5907	6117	6327	6537	6747	6957	7167	7377	7587	7797	8007	8217	8637

Upholstery Requirements
 Fabric yds: 11.5 Leather Sq. Ft.: 207
 Carton Weight: 124

2 Select Finish

[Click to view finishes](#)

NA

3 Combination Fabrics

[Click to view finishes](#)

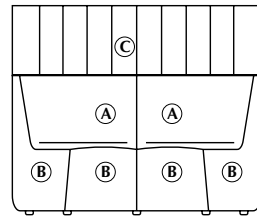

DARRAN is pleased to offer customers the design freedom of combination fabrics. When using fabric, vinyl or leather combinations, pricing/yardage requirements will be as follows:

- A Inside Back & Seat 3 yds
- B Lounge Exterior 6 yds
- C Privacy Screen 5 yds

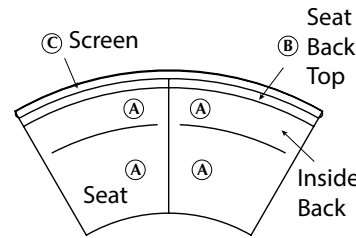

- When combining two materials of the same grade, pricing will be specified grade + 5%
- If combining two materials of different grades or leather/fabric combination, use the highest grade/price + 5%
- If using COM or COL, pricing will be COM or COL + 5%.
- If both COM + COL are used in combination, use COL + 5%.

Node Power Placement Option

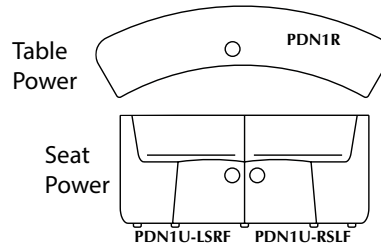

Product Features

- Horizontal back provides easy ganging capabilities.
- Utilizes elastic webbing suspension that conforms to individual's lumbar curvatures for adaptive support.
- Upholstered Privacy Screen
- Upholstered screens can be specified in contrasting fabrics, vinyl, or leathers.
- All units are standard with 1" adjustable glides that allow for leveling

Options

Ganging Device

- GDEV-L: Left Facing Ganging Device - \$20
- GDEV-R: Right Facing Ganging Device - \$20
- GDEV-C: Center Ganging Device - \$40

Power

- PDN1U-LSRF: Node in Left Seat Right Facing Seat Front; 1 Power/1 USB Charger - \$355
- PDN1U-RSLF: Node in Right Seat Left Facing Seat Front; 1 Power/1 USB Charger - \$355
- PDN1U-BC: Node in Both Left and Right Facing Center Seat Front; 1 Power/1 USB Charger per pod - \$709
- PDN1R: Node in Rear Mount Table Top; 1 Power/1 USB Charger - \$409
- Standard in White (Available in Silver and Black)

1/2" Compact Matte Laminate Rear Table

- Matte Laminate RTD63: Rear Work Table - \$1,472

- Rear table available on units that gang providing stability
- Rear table is mounted at 35.5"

1/2" Compact Matte Laminate Tablet

- FFD: 1/2" Compact Matte Laminate Tablet - \$622
- Tablet is center mount only

Premium Finish Option (Standard White)

- Specify rear table bracket Metal Finish color - \$100 per unit
- Specify tablet Metal Finish color - \$100 per unit
- MFS: Silver, MFB: Black

Bota

45 Deg. Circlet - Double Seat Low Back
 45 Degree Back Inside Radius - Low Back

[Click here to view statement of line](#)

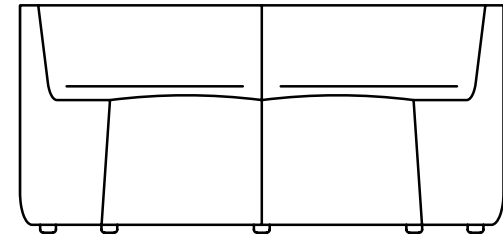

1 Model BOT0160LCS45

w" x d" x h"
 60.25 x 28.5 x 28.25
 Arm Height -
 Seat Height 17.5
 Inside Seat Depth 17
 Inside Seat Width 29.5

COM	COL	1	2	3	4	5	6	7	8	9	10	11/L1	12	13/L2
3459	3587	3715	3843	3971	4099	4227	4355	4483	4611	4739	4867	4995	5123	5379

Upholstery Requirements
 Fabric yds: 7 Leather Sq. Ft.: 126
 Carton Weight: 84

2 Select Finish

[Click to view finishes](#)

NA

3 Combination Fabrics

[Click to view finishes](#)

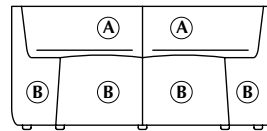

DARRAN is pleased to offer customers the design freedom of combination fabrics. When using fabric, vinyl or leather combinations, pricing/yardage requirements will be as follows:

A Inside Back & Seat 2 yds
 B Lounge Exterior 7 yds

Seat Back Top

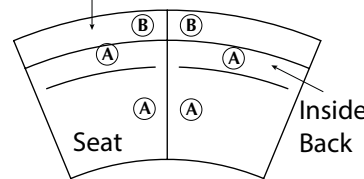

- When combining two materials of the same grade, pricing will be specified grade + 5%
- If combining two materials of different grades or leather/fabric combination, use the highest grade/price + 5%
- If using COM or COL, pricing will be COM or COL + 5%.
- If both COM + COL are used in combination, use COL + 5%.

Node Power Placement Option

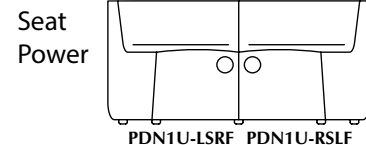
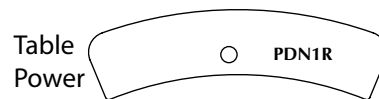

Product Features

- Horizontal back provides easy ganging capabilities.
- Utilizes elastic webbing suspension that conforms to individual's lumbar curvatures for adaptive support.
- All units are standard with 1" adjustable glides that allow for leveling

Options

Ganging Device

- GDEV-L: Left Facing Ganging Device - \$20
- GDEV-R: Right Facing Ganging Device - \$20
- GDEV-C: Center Ganging Device - \$40

Power

- PDN1U-LSRF: Node in Left Seat Right Facing Seat Front; 1 Power/1 USB Charger - \$355
- PDN1U-RSLF: Node in Right Seat Left Facing Seat Front; 1 Power/1 USB Charger - \$355
- PDN1U-BC: Node in Both Left and Right Facing Center Seat Front; 1 Power/1 USB Charger per pod - \$709
- PDN1R: Node in Rear Mount Table Top; 1 Power/1 USB Charger - \$409
- Standard in White (Available in Silver and Black)

1/2" Compact Matte Laminate Rear Table

- Matte Laminate RTD60: Rear Work Table - \$1,374
- Rear table available on units that gang providing stability
- Rear table is mounted at 28.5"

1/2" Compact Matte Laminate Tablet

- FFD: 1/2" Compact Matte Laminate Tablet - \$622,

- Tablet is center mount only

Premium Finish Option (Standard White)

- Specify rear table bracket Metal Finish color - \$100 per unit
- Specify tablet Metal Finish color - \$100 per unit
- MFS: Silver, MFB: Black

Bota

45 Deg. Circlet - Double Seat Low Back With Privacy Screen
 45 Degree Back Inside Radius - Low Back - 10.5" Privacy Screen

[Click here to view statement of line](#)

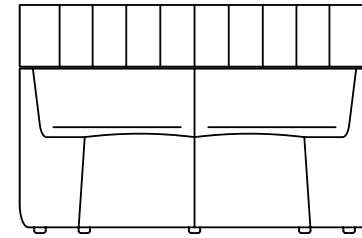

1 Model BOT0160LCL45

w" x d" x h"
 60.25 x 28.5 x 39
 Arm Height -
 Seat Height 17.5
 Inside Seat Depth 17
 Inside Seat Width 29.5

COM	COL	1	2	3	4	5	6	7	8	9	10	11/L1	12	13/L2
4578	4742	4906	5070	5234	5398	5562	5726	5890	6054	6218	6382	6546	6710	7038

Upholstery Requirements
 Fabric yds: 9 Leather Sq. Ft.: 162
 Carton Weight: 94

2 Select Finish

[Click to view finishes](#)

NA

3 Combination Fabrics

[Click to view finishes](#)

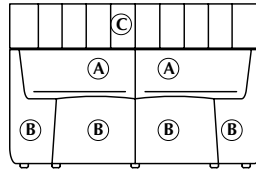

DARRAN is pleased to offer customers the design freedom of combination fabrics. When using fabric, vinyl or leather combinations, pricing/yardage requirements will be as follows:

- A Inside Back & Seat 2 yds
- B Lounge Exterior 7 yds
- C Privacy Screen 2.5 yds

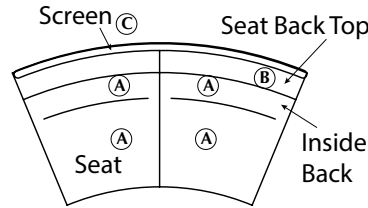

- When combining two materials of the same grade, pricing will be specified grade + 5%
- If combining two materials of different grades or leather/fabric combination, use the highest grade/price + 5%
- If using COM or COL, pricing will be COM or COL + 5%.
- If both COM + COL are used in combination, use COL + 5%.

Node Power Placement Option

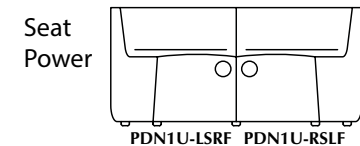
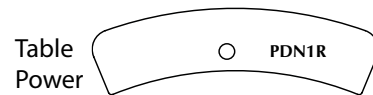

Product Features

- Horizontal back provides easy ganging capabilities.
- Utilizes elastic webbing suspension that conforms to individual's lumbar curvatures for adaptive support.
- Upholstered Privacy Screen
- Upholstered screens can be specified in contrasting fabrics, vinyl, or leathers.
- All units are standard with 1" adjustable glides that allow for leveling

Options

Ganging Device

- GDEV-L: Left Facing Ganging Device - \$20
- GDEV-R: Right Facing Ganging Device - \$20
- GDEV-C: Center Ganging Device - \$40

Power

- PDN1U-LSRF: Node in Left Seat Right Facing Seat Front; 1 Power/1 USB Charger - \$355
- PDN1U-RSLF: Node in Right Seat Left Facing Seat Front; 1 Power/1 USB Charger - \$355
- PDN1U-BC: Node in Both Left and Right Facing Center Seat Front; 1 Power/1 USB Charger per pod - \$709
- PDN1R: Node in Rear Mount Table Top; 1 Power/1 USB Charger - \$409
- Standard in White (Available in Silver and Black)

1/2" Compact Matte Laminate Rear Table

- Matte Laminate RTD60: Rear Work Table - \$1,374,
- Rear table available on units that gang providing stability
- Rear table is mounted at 28.5"

1/2" Compact Matte Laminate Tablet

- FFTD: 1/2" Compact Matte Laminate Tablet - \$622

- Tablet is center mount only

Premium Finish Option (Standard White)

- Specify rear table bracket Metal Finish color - \$100 per unit
- Specify tablet Metal Finish color - \$100 per unit
- MFS: Silver, MFB: Black

Bota

45 Deg. Circlet - Double Seat Low Back With Privacy Screen
 45 Degree Back Inside Radius - Low Back - 24.75" Privacy Screen

[Click here to view statement of line](#)

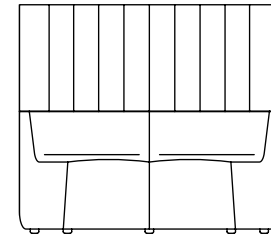

1 Model BOT0160LCH45

w" x d" x h"
 60.25 x 28.5 x 53.25
 Arm Height -
 Seat Height 17.5
 Inside Seat Depth 17
 Inside Seat Width 29.5

COM	COL	1	2	3	4	5	6	7	8	9	10	11/L1	12	13/L2
5283	5484	5685	5886	6087	6288	6489	6690	6891	7092	7293	7494	7695	7896	8298

Upholstery Requirements
 Fabric yds: 11 Leather Sq. Ft.: 198
 Carton Weight: 114

2 Select Finish

[Click to view finishes](#)

NA

3 Combination Fabrics

[Click to view finishes](#)

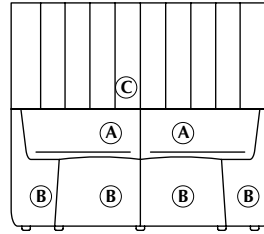

DARRAN is pleased to offer customers the design freedom of combination fabrics. When using fabric, vinyl or leather combinations, pricing/yardage requirements will be as follows:

- A Inside Back & Seat 2 yds
- B Lounge Exterior 7 yds
- C Privacy Screen 5 yds

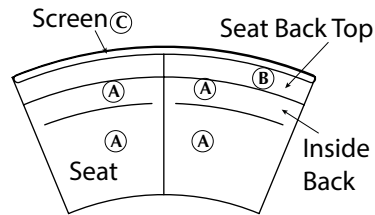

- When combining two materials of the same grade, pricing will be specified grade + 5%
- If combining two materials of different grades or leather/fabric combination, use the highest grade/price + 5%
- If using COM or COL, pricing will be COM or COL + 5%.
- If both COM + COL are used in combination, use COL + 5%.

Node Power Placement Option

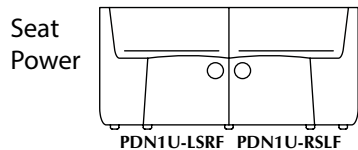
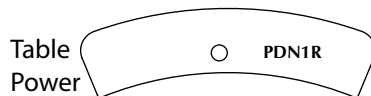

Product Features

- Horizontal back provides easy ganging capabilities.
- Utilizes elastic webbing suspension that conforms to individual's lumbar curvatures for adaptive support.
- Upholstered Privacy Screen
- Upholstered screens can be specified in contrasting fabrics, vinyl, or leathers.
- All units are standard with 1" adjustable glides that allow for leveling

Options

Ganging Device

- GDEV-L: Left Facing Ganging Device - \$20
- GDEV-R: Right Facing Ganging Device - \$20
- GDEV-C: Center Ganging Device - \$40

Power

- PDN1U-LSRF: Node in Left Seat Right Facing Seat Front; 1 Power/1 USB Charger - \$355
- PDN1U-RSLF: Node in Right Seat Left Facing Seat Front; 1 Power/1 USB Charger - \$355
- PDN1U-BC: Node in Both Left and Right Facing Center Seat Front; 1 Power/1 USB Charger per pod - \$709
- PDN1R- Node in Rear Mount Table Top; 1 Power/1 USB Charger - \$409
- Standard in White (Available in Silver and Black)

1/2" Compact Matte Laminate Rear Table

- Matte Laminate RTD60: Rear Work Table - \$1,374
- Rear table available on units that gang providing stability
- Rear table is mounted at 28.5"

1/2" Compact Matte Laminate Tablet

- FFTD: 1/2" Compact Matte Laminate Tablet - \$622

- Tablet is center mount only

Premium Finish Option (Standard White)

- Specify rear table bracket Metal Finish color - \$100 per unit
- Specify tablet Metal Finish color - \$100 per unit
- MFS: Silver, MFB: Black

Bota

45 Deg. Circlet - Double Seat High Back
 45 Degree Back Inside Radius - High Back

[Click here to view statement of line](#)

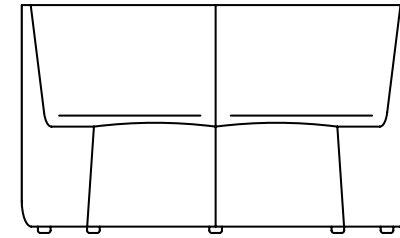

1 Model BOT0160HCS45

w" x d" x h"
 60.25 x 28.5 x 35.5
 Arm Height -
 Seat Height 17.5
 Inside Seat Depth 17
 Inside Seat Width 29.5

COM	COL	1	2	3	4	5	6	7	8	9	10	11/L1	12	13/L2
3946	4065	4184	4303	4422	4541	4660	4779	4898	5017	5136	5255	5374	5493	5731

Upholstery Requirements
 Fabric yds: 6.5 Leather Sq. Ft.: 117
 Carton Weight: 89

2 Select Finish

[Click to view finishes](#)

NA

3 Combination Fabrics

[Click to view finishes](#)

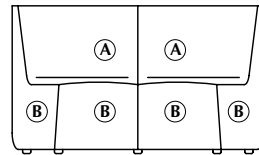

DARRAN is pleased to offer customers the design freedom of combination fabrics. When using fabric, vinyl or leather combinations, pricing/yardage requirements will be as follows:

A Inside Back & Seat 3 yds
 B Lounge Exterior 7 yds

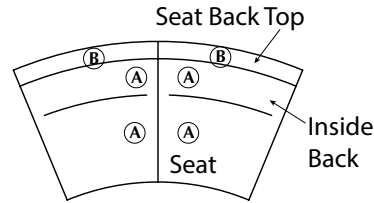

- When combining two materials of the same grade, pricing will be specified grade + 5%
- If combining two materials of different grades or leather/fabric combination, use the highest grade/price + 5%
- If using COM or COL, pricing will be COM or COL + 5%.
- If both COM + COL are used in combination, use COL + 5%.

Node Power Placement Option

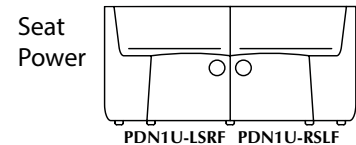

Product Features

- Horizontal back provides easy ganging capabilities.
- Utilizes elastic webbing suspension that conforms to individual's lumbar curvatures for adaptive support.
- All units are standard with 1" adjustable glides that allow for leveling

Options

Ganging Device

- GDEV-L: Left Facing Ganging Device - \$20
- GDEV-R: Right Facing Ganging Device - \$20
- GDEV-C: Center Ganging Device - \$40

Power

- PDN1U-LSRF: Node in Left Seat Right Facing Seat Front; 1 Power/1 USB Charger - \$355
- PDN1U-RSLF: Node in Right Seat Left Facing Seat Front; 1 Power/1 USB Charger - \$355
- PDN1U-BC: Node in Both Left and Right Facing Center Seat Front; 1 Power/1 USB Charger per pod - \$709
- PDN1R: Node in Rear Mount Table Top; 1 Power/1 USB Charger - \$409
- Standard in White (Available in Silver and Black)

1/2" Compact Matte Laminate Rear Table

- Matte Laminate RTD60: Rear Work Table - \$1,374
- Rear table available on units that gang providing stability
- Rear table is mounted at 35.5"

1/2" Compact Matte Laminate Tablet

- FFD: 1/2" Compact Matte Laminate Tablet - \$622

- Tablet is center mount only

Premium Finish Option (Standard White)

- Specify rear table bracket Metal Finish color - \$100 per unit
- Specify tablet Metal Finish color - \$100 per unit
- MFS: Silver, MFB: Black

Bota

45 Deg. Circlet - Double Seat High Back With Privacy Screen
 45 Degree Back Inside Radius - High Back - 10.5" Privacy Screen

[Click here to view statement of line](#)

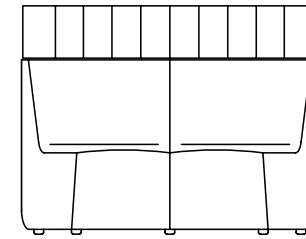

1 Model BOT0160HCL45

w" x d" x h"
 60.25 x 28.5 x 46
 Arm Height -
 Seat Height 17.5
 Inside Seat Depth 17
 Inside Seat Width 29.5

COM	COL	1	2	3	4	5	6	7	8	9	10	11/L1	12	13/L2
5134	5253	5372	5491	5610	5729	5848	5967	6086	6205	6324	6443	6562	6681	6919

Upholstery Requirements
 Fabric yds: 6.5 Leather Sq. Ft.: 117
 Carton Weight: 109

2 Select Finish

[Click to view finishes](#)

NA

3 Combination Fabrics

[Click to view finishes](#)

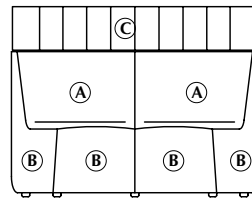

DARRAN is pleased to offer customers the design freedom of combination fabrics. When using fabric, vinyl or leather combinations, pricing/yardage requirements will be as follows:

A Inside Back & Seat 3 yds
 B Lounge Exterior 7 yds
 C Privacy Screen 2.5 yds

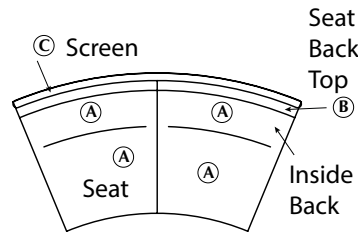

- When combining two materials of the same grade, pricing will be specified grade + 5%
- If combining two materials of different grades or leather/fabric combination, use the highest grade/price + 5%
- If using COM or COL, pricing will be COM or COL + 5%.
- If both COM + COL are used in combination, use COL + 5%.

Node Power Placement Option

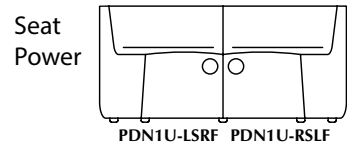
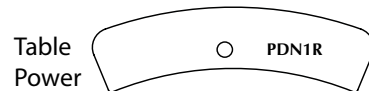

Product Features

- Horizontal back provides easy ganging capabilities.
- Utilizes elastic webbing suspension that conforms to individual's lumbar curvatures for adaptive support.
- Upholstered Privacy Screen
- Upholstered screens can be specified in contrasting fabrics, vinyl, or leathers.
- All units are standard with 1" adjustable glides that allow for leveling

Options

Ganging Device

- GDEV-L: Left Facing Ganging Device - \$20
- GDEV-R: Right Facing Ganging Device - \$20
- GDEV-C: Center Ganging Device - \$40

Power

- PDN1U-LSRF: Node in Left Seat Right Facing Seat Front; 1 Power/1 USB Charger - \$355
- PDN1U-RSLF: Node in Right Seat Left Facing Seat Front; 1 Power/1 USB Charger - \$355
- PDN1U-BC: Node in Both Left and Right Facing Center Seat Front; 1 Power/1 USB Charger per pod - \$709
- PDN1R- Node in Rear Mount Table Top; 1 Power/1 USB Charger - \$409
- Standard in White (Available in Silver and Black)

1/2" Compact Matte Laminate Rear Table

- Matte Laminate RTD60: Rear Work Table - \$1,374
- Rear table available on units that gang providing stability
- Rear table is mounted at 35.5"

1/2" Compact Matte Laminate Tablet

- FFTD: 1/2" Compact Matte Laminate Tablet - \$622

- Tablet is center mount only

Premium Finish Option (Standard White)

- Specify rear table bracket Metal Finish color - \$100 per unit
- Specify tablet Metal Finish color - \$100 per unit
- MFS: Silver, MFB: Black

Bota

45 Deg. Circlet - Double Seat High Back With Privacy Screen

45 Degree Back Inside Radius - High Back - 17.5" Privacy Screen

[Click here to view statement of line](#)

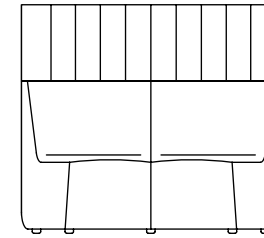

1 Model BOT0160HCH45

w" x d" x h"
60.25 x 28.5 x 53
Arm Height -
Seat Height 17.5
Inside Seat Depth 17
Inside Seat Width 29.5

COM	COL	1	2	3	4	5	6	7	8	9	10	11/L1	12	13/L2
5530	5685	5840	5995	6150	6305	6460	6615	6770	6925	7080	7235	7390	7545	7855

Upholstery Requirements
Fabric yds: 8.5 Leather Sq. Ft.: 153
Carton Weight: 119

2 Select Finish

[Click to view finishes](#)

NA

3 Combination Fabrics

[Click to view finishes](#)

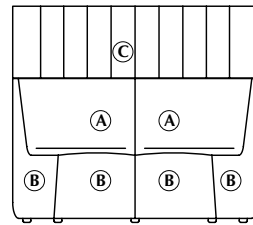

DARRAN is pleased to offer customers the design freedom of combination fabrics. When using fabric, vinyl or leather combinations, pricing/yardage requirements will be as follows:

A Inside Back & Seat 3 yds
B Lounge Exterior 7 yds
C Privacy Screen 5 yds

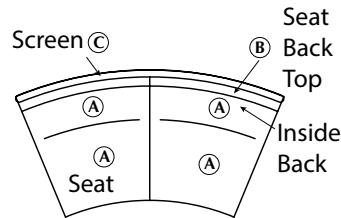

- When combining two materials of the same grade, pricing will be specified grade + 5%
- If combining two materials of different grades or leather/fabric combination, use the highest grade/price + 5%
- If using COM or COL, pricing will be COM or COL + 5%.
- If both COM + COL are used in combination, use COL + 5%.

Node Power Placement Option

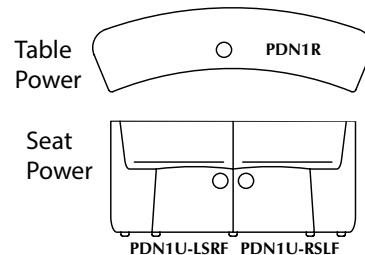

Product Features

- Horizontal back provides easy ganging capabilities.
- Utilizes elastic webbing suspension that conforms to individual's lumbar curvatures for adaptive support.
- Upholstered Privacy Screen
- Upholstered screens can be specified in contrasting fabrics, vinyl, or leathers.
- All units are standard with 1" adjustable glides that allow for leveling

Options

Ganging Device

- GDEV-L: Left Facing Ganging Device - \$20
- GDEV-R: Right Facing Ganging Device - \$20
- GDEV-C: Center Ganging Device - \$40

Power

- PDN1U-LSRF: Node in Left Seat Right Facing Seat Front; 1 Power/1 USB Charger - \$355
- PDN1U-RSLF: Node in Right Seat Left Facing Seat Front; 1 Power/1 USB Charger - \$355
- PDN1U-BC: Node in Both Left and Right Facing Center Seat Front; 1 Power/1 USB Charger per pod - \$709
- PDN1R- Node in Rear Mount Table Top; 1 Power/1 USB Charger - \$409
- Standard in White (Available in Silver and Black)

1/2" Compact Matte Laminate Rear Table

- Matte Laminate RTD60: Rear Work Table - \$1,374
- Rear table available on units that gang providing stability
- Rear table is mounted at 35.5"

1/2" Compact Matte Laminate Tablet

- FFTD: 1/2" Compact Matte Laminate Tablet - \$622.

- Tablet is center mount only

Premium Finish Option (Standard White)

- Specify rear table bracket Metal Finish color - \$100 per unit
- Specify tablet Metal Finish color - \$100 per unit
- MFS: Silver, MFB: Black

Bota

Ottoman
19" Ottoman

[Click here to view statement of line](#)

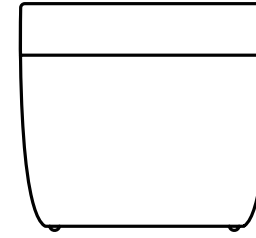

1 Model BOT0160SSO01

w" x d" x h"
19 x 19 x 17.5
Arm Height -
Seat Height 17.5
Inside Seat Depth 19
Inside Seat Width 19

COM	COL	1	2	3	4	5	6	7	8	9	10	11/L1	12	13/L2
930	966	1002	1038	1074	1110	1146	1182	1218	1254	1290	1326	1362	1398	1470

Upholstery Requirements
Fabric yds: 2 Leather Sq. Ft.: 36
Carton Weight: 23

Product Features

- 360 Degree sitting surface for wide range of uses
- Ottomans are standard with 1/4" nylon glides

Options

Compression Caster

- Caster compresses when weight is applied to ottoman.
- CST30: Caster - \$195

2 Select Finish

[Click to view finishes](#)

NA

3 Combination Fabrics

[Click to view finishes](#)

DARRAN is pleased to offer customers the design freedom of combination fabrics. When using fabric, vinyl or leather combinations, pricing/yardage requirements will be as follows:

A Seat 1 yd
B Base 2 yds

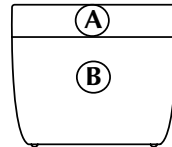

- When combining two materials of the same grade, pricing will be specified grade + 5%
- If combining two materials of different grades or leather/fabric combination, use the highest grade/price + 5%
- If using COM or COL, pricing will be COM or COL + 5%.
- If both COM + COL are used in combination, use COL + 5%.

Bota

Ottoman
48" Ottoman

[Click here to view statement of line](#)

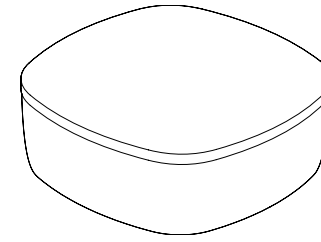

1 Model

BOT0160MSO04

w" x d" x h"
47.5 x 47.5 x 17.5
Arm Height n/a
Seat Height 17.5"
Inside Seat Depth 47.5"
Inside Seat Width 47.5"

COM	COL	1	2	3	4	5	6	7	8	9	10	11/L1	12	13/L2
2555	2628	2701	2774	2847	2920	2993	3066	3139	3212	3285	3358	3431	3504	3650

Upholstery Requirements
Fabric yds: 4 Leather Sq. Ft.: 72
Carton Weight: 75

Product Features

- 360 Degree sitting surface for wide range of uses
- Ottomans are standard with 1" adjustable glides

2 Select Finish

[Click to view finishes](#)

NA

3 Combination Fabrics

[Click to view finishes](#)

DARRAN is pleased to offer customers the design freedom of combination fabrics. When using fabric, vinyl or leather combinations, pricing/yardage requirements will be as follows:

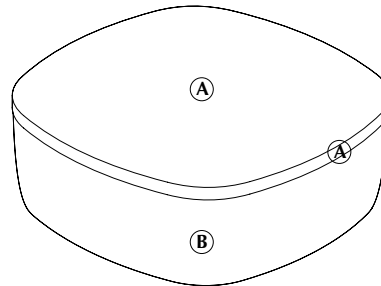

A Seat 2.75 yds
B Base 2.25 yds

Node Power Placement Option

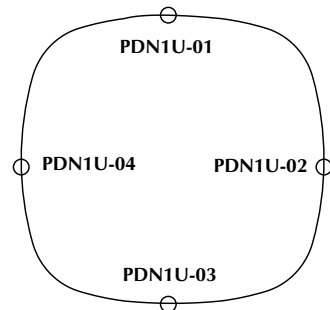

Top View

- When combining two materials of the same grade, pricing will be specified grade + 5%
- If combining two materials of different grades or leather/fabric combination, use the highest grade/price + 5%
- If using COM or COL, pricing will be COM or COL + 5%.
- If both COM + COL are used in combination, use COL + 5%.

Options

Ottoman Power

- PDN1U-01: Node in top face; 1 power/1 USB charger - \$325
- PDN1U-02: Node in right face; 1 power/1 USB charger - \$325
- PDN1U-03: Node in bottom face; 1 power/1 USB charger - \$325
- PDN1U-04: Node in left face; 1 power/1 USB charger - \$325

Bota

Ottoman
70" Ottoman

[Click here to view statement of line](#)

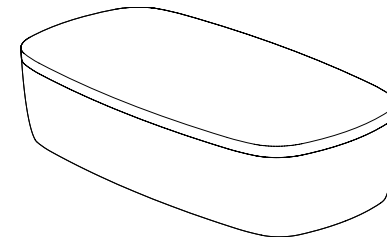

1 Model BOT0160MSO07

w" x d" x h"
71 x 35.5 x 17.5
Arm Height n/a
Seat Height 17.5"
Inside Seat Depth 35.5"
Inside Seat Width 71"

COM	COL	1	2	3	4	5	6	7	8	9	10	11/L1	12	13/L2
3582	3669	3756	3843	3930	4017	4104	4191	4278	4365	4452	4539	4626	4713	4887

Upholstery Requirements
Fabric yds: 4.75 Leather Sq. Ft.: 85.5
Carton Weight: 100

2 Select Finish

[Click to view finishes](#)

NA

3 Combination Fabrics

[Click to view finishes](#)

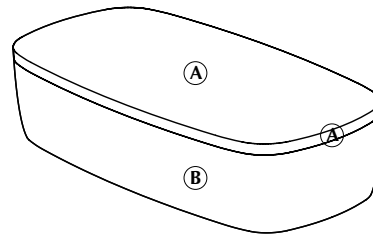

DARRAN is pleased to offer customers the design freedom of combination fabrics. When using fabric, vinyl or leather combinations, pricing/yardage requirements will be as follows:

A Seat 2.75 yds
B Base 2.5 yds

Node Power Placement Option

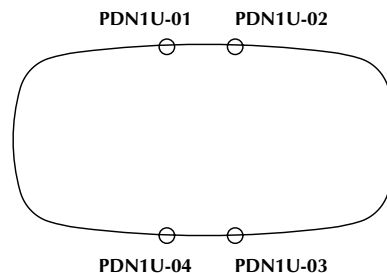

Top View

- When combining two materials of the same grade, pricing will be specified grade + 5%
- If combining two materials of different grades or leather/fabric combination, use the highest grade/price + 5%
- If using COM or COL, pricing will be COM or COL + 5%.
- If both COM + COL are used in combination, use COL + 5%.

Product Features

- 360 Degree sitting surface for wide range of uses
- Ottomans are standard with 1" adjustable glides

Options

Ottoman Power

- PDN1U-01: Node in top face; 1 power/1 USB charger - \$325
- PDN1U-02: Node in right face; 1 power/1 USB charger - \$325
- PDN1U-03: Node in bottom face; 1 power/1 USB charger - \$325
- PDN1U-04: Node in left face; 1 power/1 USB charger - \$325

Bota

Booth
4 Person Meeting Booth

[Click here to view statement of line](#)

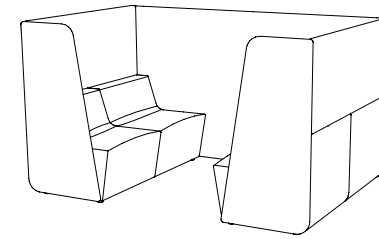

1 Model BOT0160BNT04

w" x d" x h"
95 x 63 x 53
Arm Height n/a
Seat Height 17.5"
Inside Seat Depth 17"
Inside Seat Width 29.5"

COM	COL	1	2	3	4	5	6	7	8	9	10	11/L1	12	13/L2
15039	15413	15964	16420	16876	17332	17788	18244	18700	19156	19612	20068	20524	20980	21892

Upholstery Requirements
Fabric yds: 25 Leather Sq. Ft.: 450
Carton Weight: 300

2 Select Finish

[Click to view finishes](#)

NA

3 Combination Fabrics

[Click to view finishes](#)

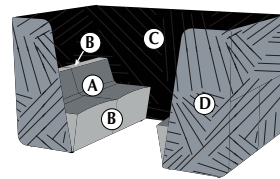

Top View

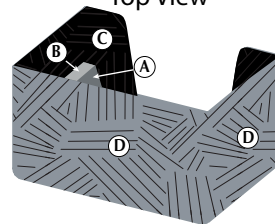

Node Power Placement Option

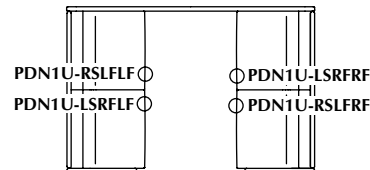

DARRAN is pleased to offer customers the design freedom of combination fabrics. When using fabric, vinyl or leather combinations, pricing/yardage requirements will be as follows:

- A Inside Back & Seat 5 yds
- B Lounge Top/Bottom Side 3 yds
- C Booth Wall Interior 8 yds
- D Booth Wall Exterior 10 yds

- When combining two materials of the same grade, pricing will be specified grade + 5%
- If combining two materials of different grades or leather/fabric combination, use the highest grade/price + 5%
- If using COM or COL, pricing will be COM or COL + 5%.
- If both COM + COL are used in combination, use COL + 5%.

Product Features

- Utilizes elastic webbing suspension that conforms to individual's lumbar curvatures for adaptive support
- Horizontal back provides easy ganging capabilities
- Upholstered screens can be specified in contrasting fabrics, vinyl or leather
- The upholstered wall is structured so that a TV up to 32" can be mounted on the inside or outside back wall of the booth
- Wire management channels are built into the wall to conceal cords
- All units are standard with 1" adjustable glides that allow for leveling

Notes

- Please consult customer service when specifying a table other than Bota to ensure adequacy of seat access

Options

Boards

- MBOC3421: 34" x 21" Marker board - \$440 ea.
- GBOC3421: 34" x 21" Glassboard - \$1098 ea.
- Specify location: interior, exterior, or both

Seat Power

- PDN1U-RSLFLF: Node in right facing seat front, left facing seat - \$387
- PDN1U-LSRFLF: Node in left facing seat front, left facing seat - \$355
- PDN1U-LSRFRF: Node in left facing seat front, right facing seat - \$355
- PDN1U-RSLFRF: Node in right facing seat front, right facing seat - \$355

TV Mount

- TM-1732: Fixed TV mount supports 17"- 32" TV - \$225
- Specify interior or exterior fixed TV mount location (2) TM71 black or TM70 white grommets included for TV wire entry and exit

Bota

Booth
6 Person Meeting Booth

[Click here to view statement of line](#)

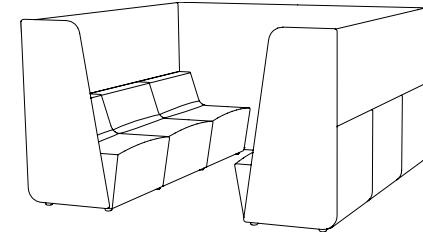

1 Model BOT0160BNT06

w" x d" x h"
95 x 91 x 53
Arm Height n/a
Seat Height 17.5"
Inside Seat Depth 17"
Inside Seat Width 29.5"

COM	COL	1	2	3	4	5	6	7	8	9	10	11/L1	12	13/L2
19462	20046	20630	21214	21798	22382	22966	23550	24134	24718	25302	25886	26470	27054	28222

Upholstery Requirements
Fabric yds: 32 Leather Sq. Ft.: 576
Carton Weight: 450

2 Select Finish

[Click to view finishes](#)

NA

3 Combination Fabrics

[Click to view finishes](#)

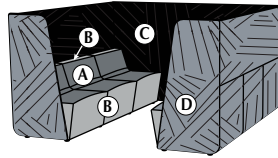

Top View

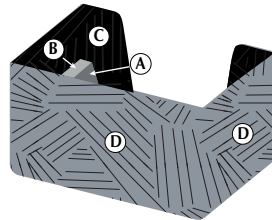

DARRAN is pleased to offer customers the design freedom of combination fabrics. When using fabric, vinyl or leather combinations, pricing/yardage requirements will be as follows:

- A Inside Back & Seat 7 yds
- B Lounge Top/Bottom Side 4 yds
- C Booth Wall Interior 9.5 yds
- D Booth Wall Exterior 12 yds

- When combining two materials of the same grade, pricing will be specified grade + 5%
- If combining two materials of different grades or leather/fabric combination, use the highest grade/price + 5%
- If using COM or COL, pricing will be COM or COL + 5%.
- If both COM + COL are used in combination, use COL + 5%.

Node Power Placement Option

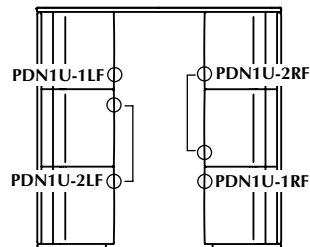

Product Features

- Utilizes elastic webbing suspension that conforms to individual's lumbar curvatures for adaptive support
- Horizontal back provides easy ganging capabilities
- Upholstered screens can be specified in contrasting fabrics, vinyl or leather
- The upholstered wall is structured so that a TV up to 32" can be mounted on the inside or outside back wall of the booth
- Wire management channels are built into the wall to conceal cords
- All units are standard with 1" adjustable glides that allow for leveling

Notes

- Please consult customer service when specifying a table other than Bota to ensure adequacy of seat access

Options

Boards

- MBOC3421: 34" x 21" Marker board - \$440 ea.
- GBOC3421: 34" x 21" Glassboard - \$1145 ea.
- Specify location: interior, exterior, or both

Seat Power

- PDN1U-1LF: Node is right facing seat front, left facing seat - \$355
- PDN1U-2LF: Node in left and center facing seat front, left facing seat - \$709
- PDN1U-1RF: Node in right facing seat front, right facing seat - \$355
- PDN1U-2RF: Node in left and center facing seat front, right facing seat - \$709

TV Mount

- TM-1732: Fixed TV mount supports 17"- 32" TV - \$225
- Specify interior or exterior fixed TV mount location (2) TM71 black or TM70 white grommets included for TV wire entry and exit

Bota

Booth Table
4 Person Meeting Booth Table

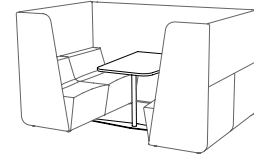

[Click here to view statement of line](#)

1 Select Model

w" x d" x h"
48 x 35 x 29

Weight
70

Standard Veneer Top White Metal Base	Premium Veneer Top White Metal Base	High Pressure Laminate Top White Metal Base	Thermally Fused Laminate Top White Metal Base
BOT4835MT500W 2200		BOT4835MT500G 2200	BOT4835MT500M 1641

Product Features

- Table legs come standard in white (optional black or silver)

Options

Worksurface Clamp Mount Power

- PD-KENO-B: Keno power pod with clamp (includes 2 wire management grommets) - \$311 ea.
- Specify color and interior or exterior wire exit
- PD-TULLY-B: Tully power pod with clamp (includes 2 wire management grommets) - \$447 ea.
- Specify color and interior or exterior wire exit
- PD-TULLY-DATA: Tully data power pod with clamp (includes 2 wire management grommets) - \$436 ea.
- Specify color and interior or exterior wire exit

Premium Finish Option

- Specify base Metal Finish color - \$160 per base
- MFS: Silver, MFB: Black

2 Select Finish

[Click to view finishes](#)

3 Select Edge

[Click to view edges](#)



4 Select Hardware

[Click to view details](#)

Hardware
N/A

Hardware
N/A

Hardware
N/A

Hardware
N/A

Bota

Booth Table 6 Person Meeting Booth Table

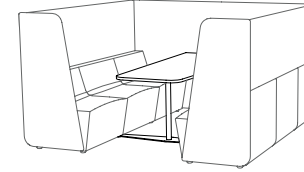

[Click here to view statement of line](#)

1 Select Model

w" x d" x h"
78 x 35 x 29

Weight
95

Standard Veneer Top White Metal Base	Premium Veneer Top White Metal Base	High Pressure Laminate Top White Metal Base	Thermally Fused Laminate Top White Metal Base
BOT7835MT500W 3079		BOT7835MT500G 3079	BOT7835MT500M 2103

Product Features

- Table legs come standard in white (optional black or silver)

Options

Worksurface Clamp Mount Power

- PD-KENO-B: Keno power pod with clamp (includes 2 wire management grommets) - \$311 ea.
- Specify color and interior or exterior wire exit
- PD-TULLY-B: Tully power pod with clamp (includes 2 wire management grommets) - \$447 ea.
- Specify color and interior or exterior wire exit
- PD-TULLY-DATA: Tully data power pod with clamp (includes 2 wire management grommets) - \$436 ea.
- Specify color and interior or exterior wire exit

Premium Finish Option

- Specify base Metal Finish color - \$160 per base
- MFS: Silver, MFB: Black

2 Select Finish

[Click to view finishes](#)

3 Select Edge

[Click to view edges](#)



Flat



Flat



Flat



Flat

4 Select Hardware

[Click to view details](#)

Hardware
N/A

Hardware
N/A

Hardware
N/A

Hardware
N/A

Bota

Freestanding Table
Freestanding Table



[Click here to view statement of line](#)

1 Select Model

w" x d" x h"
12.5 x 13.75 x 24.5

Weight
15

Standard Veneer Top Black Metal Base	1/2" Compact Laminate Top Black Metal Base		
BOT0160FST01W 898	BOT0160FST01M 868		

Product Features

- Standard Black Base (optional White, Silver)

Options

Premium Finish Option

- Specify base Metal Finish color - \$160 per base
- MFW: White, MFS: Silver

2 Select Finish

[Click to view finishes](#)

3 Select Edge

[Click to view edges](#)

Edge
N/A

Edge
N/A

4 Select Hardware

[Click to view details](#)

Hardware
N/A

Hardware
N/A

Bota
Coat Stand
Wire Coat Stand



[Click here to view statement of line](#)

1 Select Model

w" x d" x h"
20.25 x 18.5 x 67

Weight

25

Black Metal Coat Stand

BOT0160WCS01 1215

Product Features

- Standard Black Finish

2 Select Finish

[Click to view finishes](#)

3 Select Edge

[Click to view edges](#)

Edge
N/A

4 Select Hardware

[Click to view details](#)

Hardware
N/A

Keno power unit

Style Number	List Price
 PD-KENO-B	\$311

Specifications

- > Size 5.5"L x 2.125"W x 2.5"H
- > 2 TR AC Outlets
- > 14.2A USB module w/ 2 charging ports
- > 10' Power cord
- > Includes 2 wire management grommets

Available: Bota booth table



White



Black

Node power unit

Style Number List Price



STARTER UNITS

PDN1U PLUG \$325

Includes (1) node unit with plug infeed - includes 72" cord
*See pod placement options below

Specifications

- > Size: 4"Dia
- > (1) 15 Amp Receptacles and (1) USB duplex
- > Surface Mount
- > Standard White Finish, Available in Black or Silver Finish upon request
- > UL Approved

Available: Bota



Node Power Placement

