



## Conferencing Price List

Effective April 1, 2024

Date	Page	Modification	Description
04.04.24		Updated Pricing	

Statement of Line  
Features & Advantages..... 1  
Finishes | Specifications ..... 3  
Edges ..... 4  
Pulls | Knobs ..... 5  
Grommets | Grommet Reference..... 6  
Ganging | Height Reference ..... 7  
Tables..... 8  
Drum Bases..... 20  
Cube Bases..... 24  
Modesty Trough..... 32  
Panel Pedestal Bases ..... 33  
Traditional Bases..... 37  
Metal Bases ..... 38  
Conferencing Legs ..... 44  
Capitol Park Conferencing ..... 45  
Central Park Conferencing ..... 47  
Jamestown Conferencing ..... 42  
Not So Square Conferencing..... 55  
Prado Conferencing..... 58  
Richmond Park Conferencing ..... 60  
Rift Conferencing..... 62  
Options ..... 71  
Power & Data..... 78  
Table Base Matrix..... 88

Statement of Line

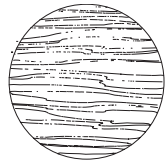

Page 8  
Tables - Conference  
Round

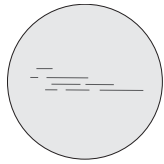

Page 9  
Glass Tables - Conference  
Round

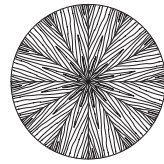

Page 10  
Tables - Conference  
Sunburst Round

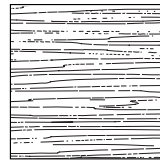

Page 11  
Tables - Conference  
Square



Page 12  
Glass Tables - Conference  
Square

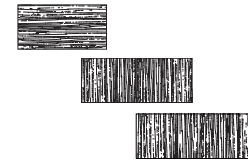

Page 13  
Tables - Conference  
Rectangle

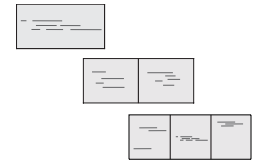

Page 14  
Glass Tables - Conference  
Rectangle

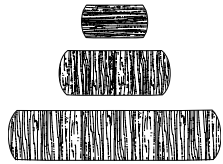

Page 15  
Tables - Conference  
Arc End

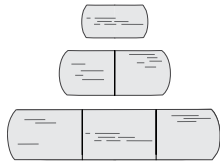

Page 16  
Glass Tables - Conference  
Arc End

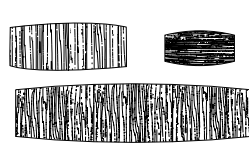

Page 17  
Tables - Conference  
Boat

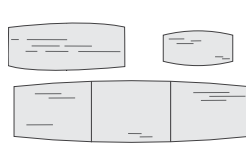

Page 18  
Glass Tables - Conference  
Boat

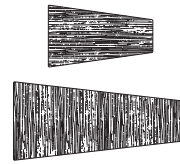

Page 19  
Telecom Tables - Conference  
Wedge



Page 20  
Drum Bases - Conference  
Wood Drum

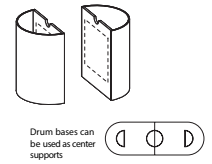

Page 21  
Drum Bases - Conference  
Half Wood Drum

Drum bases can be used as center supports

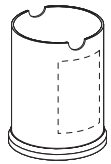

Page 22  
Drum Bases - Conference  
Transitional Wood Cylinder Base

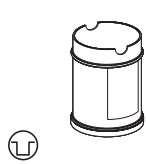

Page 23  
Traditional Drum Bases - Conference  
Traditional Drum

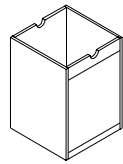

Page 24  
Cube Bases - Conference  
Contemporary Cube Base

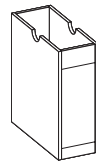

Page 25  
Cube Bases - Conference  
Contemporary Half Cube

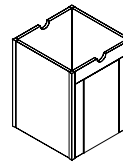

Page 26  
Cube Bases - Conference  
Contemporary Cube W/ Metal Detail

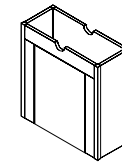

Page 27  
Cube Post Bases - Conference  
Contemporary Half Cube With Metal Detail

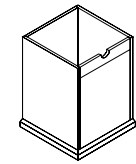

Page 28  
Cube Bases - Conference  
Transitional Cube

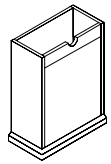

Page 29  
Cube Bases - Conference  
Transitional Half Cube

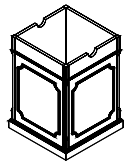

Page 30  
Traditional Cube Bases - Conference  
Full Traditional Cabinet Bases

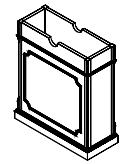

Page 31  
Traditional Cube Bases - Conference  
Half Traditional Cabinet Base

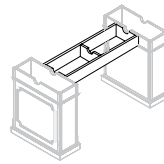

Page 32  
Modesty Trough / Tray Bases - Conference  
4 3/4" H Wire Trough Modesty

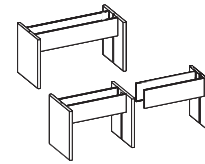

Page 33  
Panel Base W/ Wire Management  
Modesty - Conference  
Panel Base

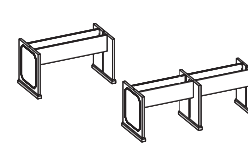

Page 34  
Panel Base W/ Wire Management  
Modesty - Conference  
Traditional Panel Base

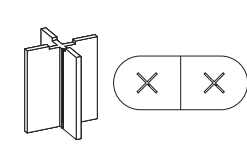

Page 35  
Panel Pedestal Bases - Conference  
Panel X Base

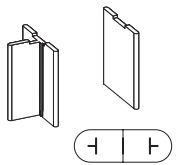

Page 36  
Panel Pedestal Bases - Conference  
Panel T Base

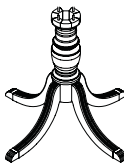

Page 37  
Traditional Bases - Conference  
Traditional Duncan Phyfe Pedestal Base

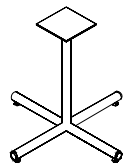

Page 38  
Metal Bases - Conference  
Column "X" Series

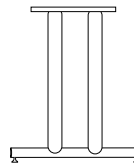

Page 39  
Metal Bases - Conference  
Metal Column T-Leg

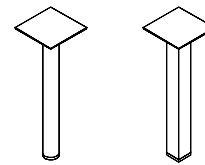

Page 40  
Metal Bases - Conference  
Metal Leg - Kd



Page 41  
Metal Bases - Conference  
Tapered Metal Leg

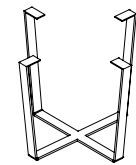

Page 42  
Metal Bases - Conference  
Metal Angled Sleigh Base

Statement of Line

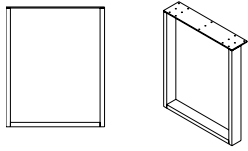

Page 43  
Central Park Base - Conference - Central Park  
Single Metal "U" Shaped Leg

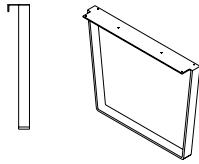

Page 44  
Conferring Legs - Conference  
Single Metal Leg

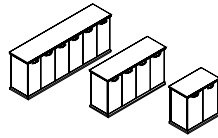

Page 45  
Full Pedestal Credenzas - Conference - Capitol Park  
Conferring Storage Credenza

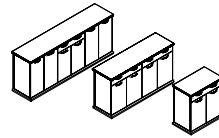

Page 46  
Full Pedestal Credenzas - Conference - Capitol Park  
Conferring Buffet Credenza

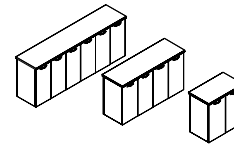

Page 47  
Full Pedestal Credenzas - Conference - Central Park  
Conferring Storage Credenza

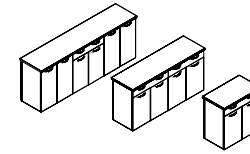

Page 48  
Full Pedestal Credenzas - Conference - Central Park  
Conferring Buffet Credenza

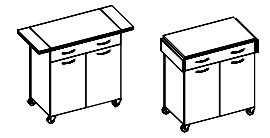

Page 49  
Conferring Caseloads - Conference - Central Park  
Mobile Extension Buffet Cart



Page 50  
Visual Boards - Conference - Central Park  
Visual Board

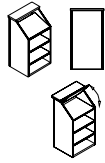

Page 51  
Lecterns - Conference - Central Park  
Lectern

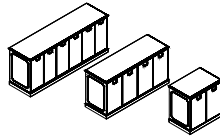

Page 52  
Full Pedestal Credenzas - Conference - Jamestown  
Conferring Storage Credenza

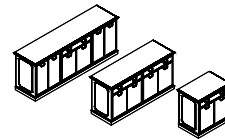

Page 53  
Full Pedestal Credenzas - Conference - Jamestown  
Conferring Buffet Credenza



Page 54  
Cabinets - Conference - Jamestown  
Traditional Telephone Cabinet

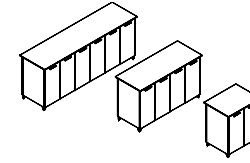

Page 55  
Full Pedestal Credenzas - Conference - NOT SO square  
Conferring Storage Credenza

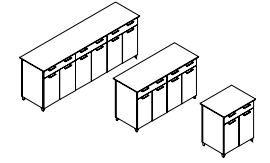

Page 56  
Storage Credenzas - Conference - NOT SO square  
Buffet / Storage Credenzas

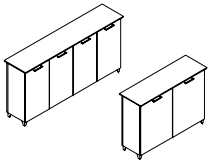

Page 57  
Storage Credenzas - Conference - NOT SO square  
Console Cabinets

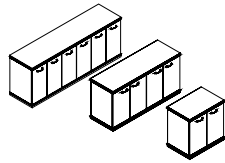

Page 58  
Full Pedestal Credenzas - Conference - Prado  
Conferring Storage Credenza

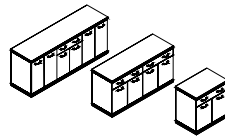

Page 59  
Full Pedestal Credenzas - Conference - Prado  
Conferring Buffet Credenza

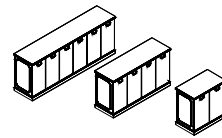

Page 60  
Full Pedestal Credenzas - Conference - Richmond Park  
Conferring Storage Credenza

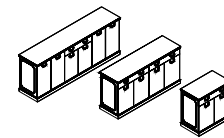

Page 61  
Full Pedestal Credenzas - Conference - Richmond Park  
Conferring Buffet Credenza

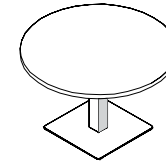

Page 62  
Conference Table - Conference - Rift  
Round Conference Table With Column

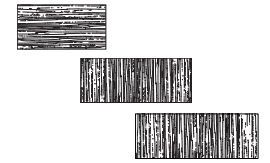

Page 63  
Top - Conference - Rift  
Rectangle

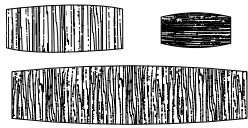

Page 64  
Top - Conference - Rift  
Boat

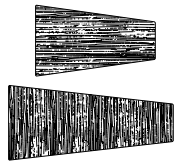

Page 65  
Top - Conference - Rift  
Telecom Wedge

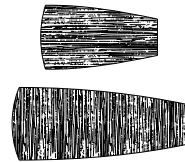

Page 66  
Top - Conference - Rift  
Midship

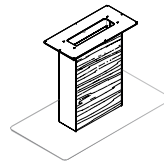

Page 67  
Bases - Conference - Rift  
Stationary Base

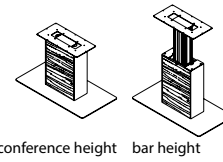

Page 68  
Bases - Conference - Rift  
Adjustable Height Base

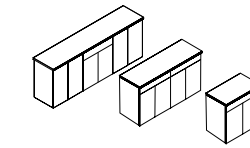

Page 69  
Credenzas - Conference - Rift  
Buffet Credenza

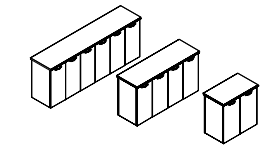

Page 70  
Credenzas - Conference - Rift  
Storage Credenza

### Veneer and HPL tops

Veneer tops and high-pressure laminate tops feature a 45-pound density substrate with balanced 3-ply construction. Tops are 1-1/8" thick. DARRAN only uses HPVA A Grade Flat Cut Cherry, Maple, and Walnut Veneers and A Grade Quartered Oak. Cherry and Walnut veneers are book-matched. Oak, Maple, and Ash Veneers are slip-matched. Veneer tops feature a 3mm external solid hardwood band, HPL tops features a 2mm flat PVC band or a 1mm laminate self-edge. Some collections feature double cut reconstituted walnut and oak veneers.

### TFL tops

Thermally Fused Laminate tops feature a 45-pound density substrate with balanced 3-ply construction. Tops are 1-1/8" thick. Laminate tops feature a 2mm flat PVC band.

### Chassis & pedestal

All pedestals and chassis are constructed with 3/4" thick balanced 3-ply panels. Panels are securely fastened together using rails that are bored and doweled, glued, metal reinforcement brackets and wood cleat construction. Thick end panels are pre-bored to accept a tee nut for the adjustable glide and are reinforced with pvc banding to prevent glide tear out. Glue blocks are used where 3/4" thick panels are joined, bored for tee nut to accept adjustable glide.

### Adjustable glides

Glides provide 1" of vertical leveling adjustment. Glide bottom is durable metal.

### Drawers

All drawers are constructed of four sides and a bottom, which are attached to a drawer front with screws for easy removal. Drawer fronts feature vertically matched veneer within each pedestal. Pencil trays are standard in all box drawers. Jamestown, Prado, Rift, and Spaces feature maple veneer 1/2" thick material for drawer sides, fronts and backs with a UV finish for maximum durability. Drawer bottoms are 7/32" thick 3-ply maple veneer. Drawer boxes are assemble at each corner with dowel joinery for maximum drawer strength. Capitol Park, Central Park, NSsq, Reception Park, and Richmond Park feature drawers that are 1/2" thick wood grained wrapped 5 sided miter-folded construction with 1/8" thick hardboard bottoms.

### Drawer fronts

Drawer fronts are vertically matched in balanced sets. Doors feature vertical veneer bookmatched horizontally in sets of 2 / 4 and 6 doors. All drawers and doors have traditional scallop profile edge shape. All tower fronts matched in vertical sets.

### Suspensions

All casegoods utilize cold rolled steel zinc plated high-grade drawer suspensions. All suspensions are warranted for the lifetime of the product. Box and File drawers are full extension, featuring steel ball bearings for a smoother quieter range of motion with soft

close operation and are rated 100lbs. Lateral file drawers are a progressive action full extension suspension with the soft close operation and is rated at 150lbs. Lateral files include anti tip mechanism that will allow only one drawer at a time to be opened.

### Hinges

Units with doors include 95 degree swing hinges.

### Locks

Silver, black or bronze face locks are standard on all desks, credenzas, returns, and modular pedestals and match the color of the pull selection. Locks are optional on door storage, overhead storage, towers with doors and all door units. Each drawer pedestal is independently locked. Lock plugs are factory or field installed.

#### KEYING

Keying is available either factory or field installed. Factory installed keying is random.

### Wire management

Wire management capabilities include standard and optional worksurface grommets. Specify W-1 under surface wire channels for organization and management of all communication wires and cords. Horizontal J-Channel wire management (Sku: W-1) is sold separately to conceal wire under worksurfaces.

### Grommets

Metal grommets are provided to match the drawer pull selection. Grommet is available in black, silver, white or antique brass. Must specify standard or non-standard location. Black plastic grommets are available as an option for vertical applications.

### Powerports

A large selection of powerports are available and handle power, data, docking stations and communication. See options section for selection.

VENEER FINISHES

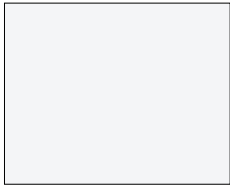

WWP Designer White Paint



WAM Alabaster Maple



WAF Narvik Ash



WCM Clear Maple



WLF Lofty Oak



WWW Weathered Walnut



WFF Fawn Cypress



WNF Natural Oak



WEF Neo Walnut



WGW Gunstock Walnut



WAC Amber Cherry



WSW Smokey Walnut



WMF Mocha Oak



WNW Natural Walnut



WBW Henna Walnut



WOC KoKo Cherry

PREMIUM VENEER



WEC Ebony Cherry



WLO Lofty Oak



TBCO Baby's Cheek



TSMV Seattle Mist



WFO Fawn Cypress



WNO Natural Oak



TOBW Organic Brown



TSTV Studio Teak

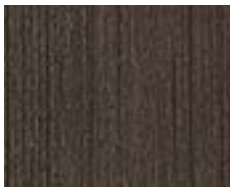

TSLV Skyline Walnut



TBSW Brown Sugar



WMO Mocha Oak

Finish

Welltech Finish delivers a superior furniture coating with exceptional performance that can withstand stringent cleaning agents and possesses unparalleled durability, allowing DARRAN to provide lasting, sustainable products to our customers.



HIGH PRESSURE LAMINATES

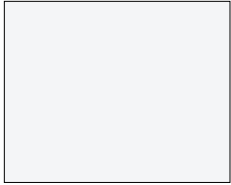

GWL Designer White

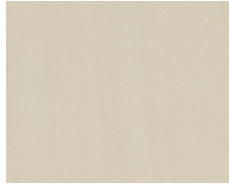

GAM Alabaster Maple



GNA Narvik Ash



GCM Clear Maple



GSTV Studio Teak



GSLV Skyline Walnut



GAC Amber Cherry



WIC Crimson Cherry



GHC Honey Cherry



GNW Natural Walnut



LW01 Neo Walnut



LW02 Fawn Cypress

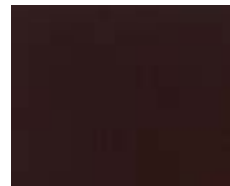

GOC KoKo Cherry



GEC Ebony

TFL LAMINATES

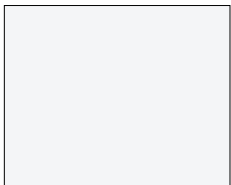

MWL Designer White



MNA Narvik Ash



MWW Weathered Walnut



MTV Studio Teak



MGW Gunstock Walnut



MAC Amber Cherry

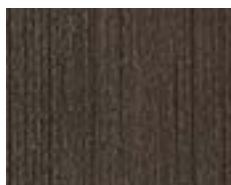

MLV Skyline Walnut



MOC KoKo Cherry



MEC Ebony



Standard Profile

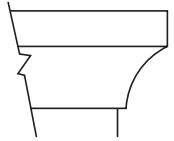

**Capitol Park**

3mm solid  
hardwood band

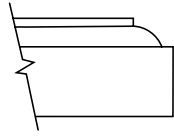

**Classic**

"W" 3mm solid  
hardwood band

"G" HPL self edge

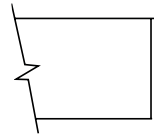

**Flat**

"W" 3mm solid  
hardwood band

"P" 3mm solid  
hardwood band

"G" HPL self edge

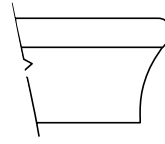

**Knife**

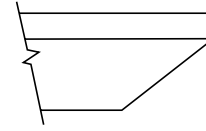

**Ledge**

"W" 3mm solid  
hardwood band

"P" 3mm solid  
hardwood band

"G" HPL self edge

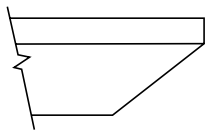

**NSS Bevel**

"W" 3mm solid  
hardwood band

"G" HPL self edge

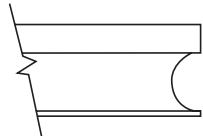

**Prado**

"W" 3mm solid  
hardwood band

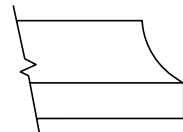

**Richmond Park**

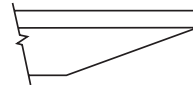

**Rift**

**"M" Standard profile**

Central Park Edges for "M" Styles  
1 mm PVC Edge with Black Foil

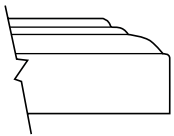

**Traditional**

"W" 3mm solid  
hardwood band

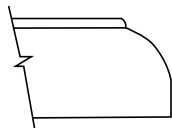

**Waterfall**

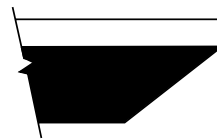

**NSS Bevel**

2 mm PVC  
Edge with Black  
Foil

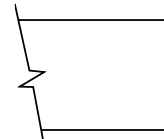

**Flat**

2 mm PVC  
Edge

Pulls/Knobs

Factory Installed



PL-4 Antique Brass



PL-5 Antique Brass  
PL-50 Brushed Pewter

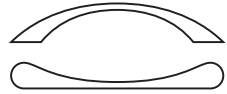

PL-105 Matte Black  
PL-106 Matte Nickel

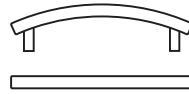

PL-112 Matte Black  
PL-113 Matte Nickel

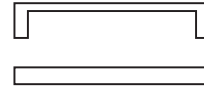

PL-115 Matte Black  
PL-116 Matte Nickel

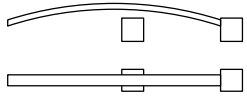

PL-125 Antique Pewter  
PL-126 Antique English  
PL-127 Matte Black

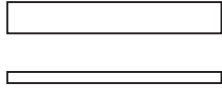

PL-210 Anodized Aluminum

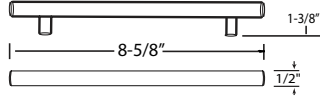

PL-310 Stainless Steel  
PL-311 Royal Brass

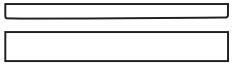

PL-300 Matte Chrome  
PL-301 Matte Chrome  
PL-302 White  
PL-303 White

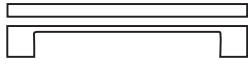

PL-304 Matte Chrome  
PL-305 Matte Chrome  
PL-306 White  
PL-307 White

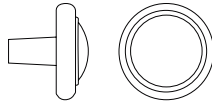

DK-4 Antique Brass

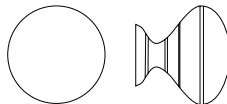

DK-114 Brushed Pewter

Finger Pulls

Arrow indicates finger pull location(not available on TFL)

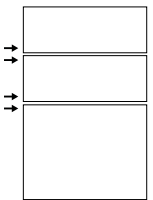

b/b/f

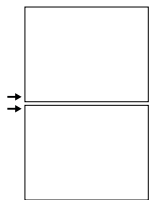

f/f

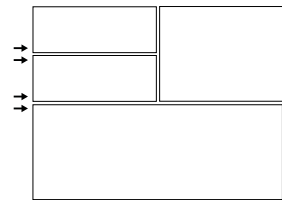

multi



lateral/lateral

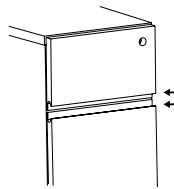

finger pull side view

TM30  
Black  
1-5/8" Dia.

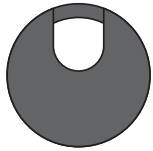

**Optional grommets**

Factory Installed

**Grommets (Standard Location)**

Specify Color and Left/Right/Center - \$50 ea.  
- Black: TM30-R (Right), TM30-L (Left), TM30-C (Center)

- Silver: TM31-R (Right), TM31-L (Left), TM31-C (Center)

- Antique Brass: TM33-R (Right), TM33-L (Left), TM33-C (Center)

- White: TM34-R (Right), TM34-L (Left), TM34-C (Center)

**Grommets (Non-Standard Location)**

Provide drawing w/ Grommet Location and Specify Color - \$95 ea.

- Black: TM30-NS

- Silver: TM31-NS

- Antique Brass: TM33-NS

- White: TM34-NS

TM31  
Silver  
1-5/8" Dia.

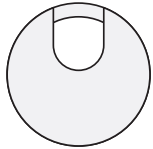

TM34  
White  
1-5/8" Dia.

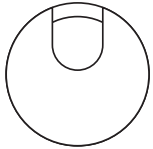

TM33  
Antique Brass  
1-5/8" Dia.

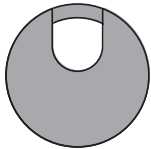

TM50  
Black  
1-5/8" Dia.



**Grommets (vertical surface)**

Standard Location - \$50 ea.

- Black Plastic Vertical Surface: TM50-C (Bottom Center)

Non-Standard Location - \$95 ea.

- Black Plastic Vertical Surface: TM50-NS

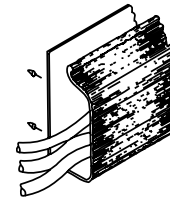

W1

**Horizontal J-Channel**

Horizontal J-Channel wire management (Sku: W-1) is sold separately to conceal wire under worksurfaces.

## Ganging – Flush Cut Modification

30”H Casegood Worksurface & Base Ganging Modifications

Depending on style some casegoods are shaped on the ends. For those collections to gang two casegood units, each unit end to be ganged must be flush cut modified for gapless surfaces and cabinet chassis.

Order Option:

- FC-B: Flush Unit Both Sides(Facing) for Ganging - \$100
- FC-L: Flush Unit Left (Facing) for Ganging - \$100
- FC-R: Flush Unit Right (Facing) for Ganging - \$100

Flush cut modification per unit includes all modifications to gang to one end or both ends when units are ganged. Modification includes tops, base and molding.

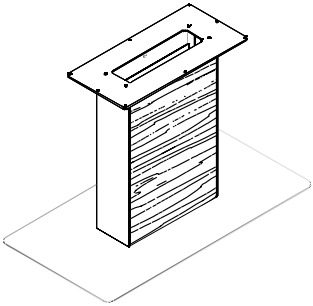

Height adjustable bases range from 29" to 49". Maximum weight capacity of 350 lbs.

Modification reduces width size approximately 1" per end.

Overhead consoles and towers are offered freestanding and ganging – inclusive of flush cut modifications.

Example:

RPC3121100W Two Drawer Lateral File (Left) Flush Cut Right – FC-R...\$100

RPC7221054 Kneespace Credenza (Right) Flush Cut Left – FC-L...\$100

# Conference

Tables  
Round

[Click here to view statement of line](#)

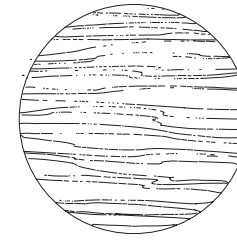

## 1 Select Model

w" x d" x h"	Weight
60 DIA x 1-1/2"	125
54 DIA x 1-1/2"	95
48 DIA x 1-1/2"	85
42 DIA x 1-1/2"	75
36 DIA	50

	Standard Veneer Top		Premium Veneer Top		High Pressure Laminate Top		Thermally Fused Laminate Top	
	TBT6060RD500W	3410	TBT6060RD500P	3751	TBT6060RD500G	3410	TBT6060RD500M	1039
	TBT5454RD500W	3016	TBT5454RD500P	3318	TBT5454RD500G	3016	TBT5454RD500M	875
	TBT4848RD500W	2422	TBT4848RD500P	2664	TBT4848RD500G	2422	TBT4848RD500M	803
	TBT4242RD500W	1984	TBT4242RD500P	2270	TBT4242RD500G	1984	TBT4242RD500M	670
	TBT3636RD500W	1806	TBT3636RD500P	1987	TBT3636RD500G	1806	TBT3636RD500M	703

## Product Features

- WellTech Finish Technology \*Environmental Coatings Technology
- 1-5/16" thick top

### Seating Accommodations

- 60" diameter seats six
- 54" diameter seats four to six
- 48" and 42" diameter seats four
- 36" diameter seats three to four

## 2 Select Finish

[Click to view finishes](#)

## 3 Select Edge

[Click to view edges](#)

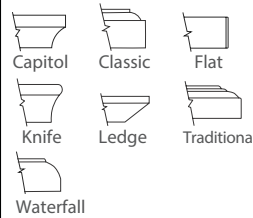
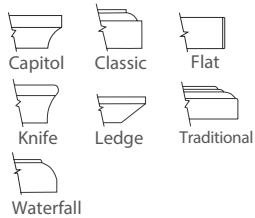

## 4 Select Hardware

[Click to view details](#)

Hardware  
N/A

Hardware  
N/A

Hardware  
N/A

Hardware  
N/A

# Conference

Glass Tables  
Round

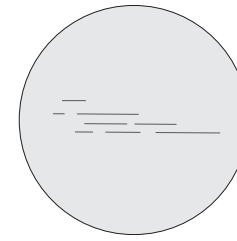

[Click here to view statement of line](#)

## 1 Select Model

w" x d" x h"	Weight
60 DIA x 1-1/2"	290
54 DIA x 1-1/2"	225
48 DIA x 1-1/2"	190
42 DIA x 1-1/2"	155

White Glass Gloss Finish		Black Glass Gloss Finish		White Glass SoftEtch ð Finish		Black Glass SoftEtch ð Finish	
TBT6060RD500SW	7367	TBT6060RD500SB	7367	TBT6060RD500EW	7367	TBT6060RD500EB	7367
TBT5454RD500SW	6155	TBT5454RD500SB	6155	TBT5454RD500EW	6155	TBT5454RD500EB	6155
TBT4848RD500SW	5065	TBT4848RD500SB	5065	TBT4848RD500EW	5065	TBT4848RD500EB	5065
TBT4242RD500SW	4102	TBT4242RD500SB	4102	TBT4242RD500EW	4102	TBT4242RD500EB	4102

## Product Features

- Subtop is recessed 3" and edge is finished to match glass
- Glass features flat polished edge
- Custom back painted colors available upon quote
- Glass is 1/2" thick with 1-1/4" subtop

## Notes

- Any Sherwin Williams, Benjamin Moore or Valspar custom back painted glass color is available for a one-time fee per order for \$1475 list.
- DARRAN makes every effort to produce back painted glass with the best available low iron material for color consistency. Low iron glass is a natural material with slight variation from sheet to sheet.
- Seating Accommodations
  - 60" diameter seats six
  - 54" diameter seats four to six
  - 48" and 42" diameter seats four to five

## 2 Select Finish

[Click to view finishes](#)

Finish N/A

Finish N/A

Finish  
N/A

Finish  
N/A

## 3 Select Edge

[Click to view edges](#)



## 4 Select Hardware

[Click to view details](#)

Hardware  
N/A

Hardware  
N/A

Hardware  
N/A

Hardware  
N/A

# Conference

## Tables Sunburst Round

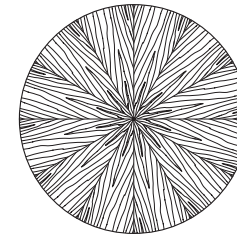

[Click here to view statement of line](#)

### 1 Select Model

w" x d" x h"	Weight
60 DIA x 1-1/2"	125
54 DIA x 1-1/2"	95
48 DIA x 1-1/2"	85
42 DIA x 1-1/2"	75

Standard Veneer Top		Premium Veneer Top		High Pressure Laminate Top	Thermally Fused Laminate Top
TBT6060SB500W	4142	TBT6060SB500P	4557	"G" Option N/A	"M" Option N/A
TBT5454SB500W	3633	TBT5454SB500P	3997	"G" Option N/A	"M" Option N/A
TBT4848SB500W	2808	TBT4848SB500P	3090	"G" Option N/A	"M" Option N/A
TBT4242SB500W	2478	TBT4242SB500P	2727	"G" Option N/A	"M" Option N/A

### Product Features

- WellTech Finish Technology \*Environmental Coatings Technology
- 1-5/16" thick top

#### Seating Accommodations

- 60" diameter seats six
- 54" diameter seats four to six
- 48" and 42" diameter seats four to five
- 36" diameter seats three to four

### 2 Select Finish

[Click to view finishes](#)

### 3 Select Edge

[Click to view edges](#)

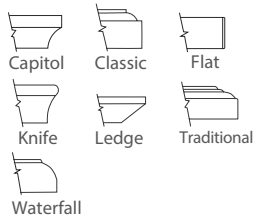

### 4 Select Hardware

[Click to view details](#)

Hardware  
N/A

Hardware  
N/A

# Conference

Tables  
Square

[Click here to view statement of line](#)

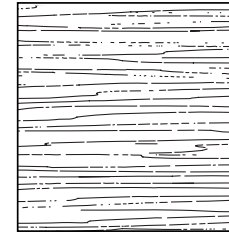

## 1 Select Model

w" x d" x h"	Weight
60 x 60 x 1-1/2"	125
54 x 54 x 1-1/2"	95
48 x 48 x 1-1/2"	85
42 x 42 x 1-1/2"	75

	Standard Veneer Top		Premium Veneer Top		High Pressure Laminate Top		Thermally Fused Laminate Top	
	TBT6060SQ500W	2725	TBT6060SQ500P	2997	TBT6060SQ500G	2725	TBT6060SQ500M	1039
	TBT5454SQ500W	2439	TBT5454SQ500P	2684	TBT5454SQ500G	2439	TBT5454SQ500M	875
	TBT4848SQ500W	1943	TBT4848SQ500P	2137	TBT4848SQ500G	1943	TBT4848SQ500M	803
	TBT4242SQ500W	1858	TBT4242SQ500P	2045	TBT4242SQ500G	1858	TBT4242SQ500M	760

## Product Features

- WellTech Finish Technology \*Environmental Coatings Technology
- 1-5/16" thick top

### Seating Accommodations

- 60" seats eight
- 54" seats four to five
- 48" and 42" seats four

## 2 Select Finish

[Click to view finishes](#)

## 3 Select Edge

[Click to view edges](#)

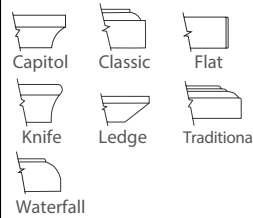
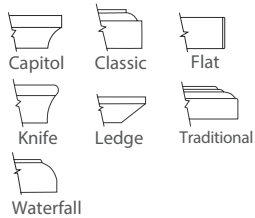

## 4 Select Hardware

[Click to view details](#)

Hardware  
N/A

Hardware  
N/A

Hardware  
N/A

Hardware  
N/A



# Conference

Glass Tables

Square

[Click here to view statement of line](#)

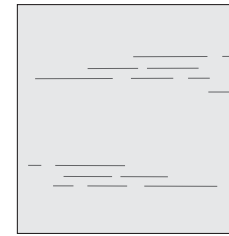

## 1 Select Model

w" x d" x h"	Weight
60 x 60 x 1-1/2"	290
54 x 54 x 1-1/2"	225
48 x 48 x 1-1/2"	190
42 x 42 x 1-1/2"	155

White Glass Gloss Finish		Black Glass Gloss Finish		White Glass SoftEtch ò Finish		Black Glass SoftEtch ò Finish	
TBT6060SQ500SW	6879	TBT6060SQ500SB	6879	TBT6060SQ500EW	6879	TBT6060SQ500EB	6879
TBT5454SQ500SW	5810	TBT5454SQ500SB	5810	TBT5454SQ500EW	5810	TBT5454SQ500EB	5810
TBT4848SQ500SW	4854	TBT4848SQ500SB	4854	TBT4848SQ500EW	4854	TBT4848SQ500EB	4854
TBT4242SQ500SW	3998	TBT4242SQ500SB	3998	TBT4242SQ500EW	3998	TBT4242SQ500EB	3998

## Product Features

- Subtop is recessed 3" and edge is finished to match glass
- Glass features flat polished edge
- Custom back painted colors available upon quote
- Glass is 1/2" thick with 1-1/4" subtop

## Notes

- Any Sherwin Williams, Benjamin Moore or Valspar custom back painted glass color is available for a one-time fee per order for \$1475 list.
  - DARRAN makes every effort to produce back painted glass with the best available low iron material for color consistency. Low iron glass is a natural material with slight variation from sheet to sheet.
- Seating Accommodations
- 60" seats eight
  - 54" seats four to five
  - 48" and 42" seats four

## 2 Select Finish

[Click to view finishes](#)

Finish N/A

Finish N/A

Finish  
N/A

Finish  
N/A

## 3 Select Edge

[Click to view edges](#)



## 4 Select Hardware

[Click to view details](#)

Hardware  
N/A

Hardware  
N/A

Hardware  
N/A

Hardware  
N/A

# Conference

Tables  
Rectangle

[Click here to view statement of line](#)

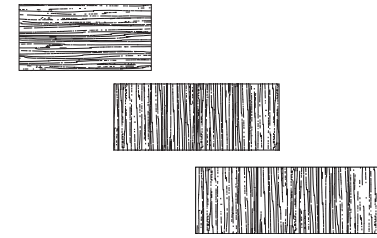

## 1 Select Model

w" x d" x h"	Weight
<b>3 Piece Top</b>	
240 x 60 x 1-1/2"	615
240 x 54 x 1-1/2"	555
<b>2 Piece Top</b>	
216 x 60 x 1-1/2"	555
216 x 54 x 1-1/2"	505
192 x 54 x 1-1/2"	450
168 x 54 x 1-1/2"	330
144 x 48 x 1-1/2"	250
120 x 48 x 1-1/2"	210
<b>1 Piece Top</b>	
96 x 48 x 1-1/2"	170
84 x 42 x 1-1/2"	130
72 x 36 x 1-1/2"	100

	Standard Veneer Top		Premium Veneer Top		High Pressure Laminate Top		Thermally Fused Laminate Top	
	TBT24060RE500W	11320	TBT24060RE500P	12453	TBT24060RE500G	11320	TBT24060RE500M	3622
	TBT24054RE500W	11172	TBT24054RE500P	12290	TBT24054RE500G	11172	TBT24054RE500M	3567
	TBT21660RE500W	9621	TBT21660RE500P	10584	TBT21660RE500G	9621		
	TBT21654RE500W	9502	TBT21654RE500P	10453	TBT21654RE500G	9502	TBT21654RE500M	3038
	TBT19254RE500W	7540	TBT19254RE500P	8295	TBT19254RE500G	7540	TBT19254RE500M	2320
	TBT16854RE500W	7337	TBT16854RE500P	8071	TBT16854RE500G	7337	TBT16854RE500M	2258
	TBT14448RE500W	6692	TBT14448RE500P	7362	TBT14448RE500G	6692	TBT14448RE500M	2057
	TBT12048RE500W	6017	TBT12048RE500P	6884	TBT12048RE500G	6017	TBT12048RE500M	1944
	TBT9648RE500W	3760	TBT9648RE500P	4302	TBT9648RE500G	3760	TBT9648RE500M	1219
	TBT8442RE500W	3780	TBT8442RE500P	4158	TBT8442RE500G	3780	TBT8442RE500M	1134
	TBT7236RE500W	3227	TBT7236RE500P	3549	TBT7236RE500G	3227	TBT7236RE500M	1007

## 2 Select Finish

[Click to view finishes](#)

## 3 Select Edge

[Click to view edges](#)

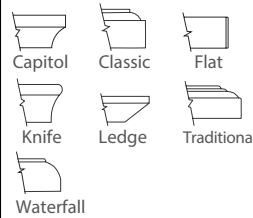
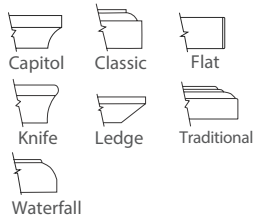

## 4 Select Hardware

[Click to view details](#)

Hardware  
N/A

Hardware  
N/A

Hardware  
N/A

Hardware  
N/A

## Product Features

- WellTech Finish Technology \*Environmental Coatings Technology
- 1-5/16" thick top

### Seating Accommodations

- 240" seats sixteen to eighteen
- 216" seats twelve to fourteen
- 192" seats ten to twelve
- 168" seats ten
- 144" and 120" seats eight to ten
- 96" and 84" seats eight
- 72" seats six to eight

## Options

### Power

- REF-310: Reef power unit with daisylink - \$1199 ea
- PD-Cove-PKO: Cove corded series - \$872 ea
- FPDB: Flush power/data bay
- Hardwired: FPDB-H72: 72" Cord - \$1363. FPDB-H108: 108" Cord - \$1300. FPDB-H144: 144" Cord - \$1350. FPDB-H180: 180" Cord - \$1400.
- Power/Plug: FPDB-C72: 72" Cord - \$1250. FPDB-C108: 108" Cord - \$1300. FPDB-C144: 144" - Cord \$1350. FPDB-C180: 180" Cord - \$1400

# Conference

Glass Tables

Rectangle

[Click here to view statement of line](#)

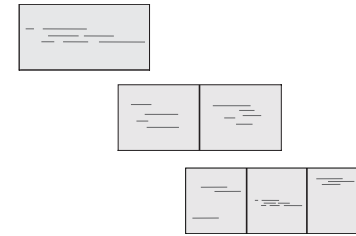

## 1 Select Model

w" x d" x h"	Weight
3 Piece Top	
240 x 60 x 1-1/2"	1270
240 x 54 x 1-1/2"	1145
2 Piece Top	
216 x 60 x 1-1/2"	1145
216 x 54 x 1-1/2"	1035
192 x 54 x 1-1/2"	920
168 x 54 x 1-1/2"	740
144 x 48 x 1-1/2"	565
120 x 48 x 1-1/2"	470
1 Piece Top	
96 x 48 x 1-1/2"	380
84 x 42 x 1-1/2"	290
72 x 36 x 1-1/2"	220

White Glass Gloss Finish		Black Glass Gloss Finish		White Glass SoftEtch ð Finish		Black Glass SoftEtch ð Finish	
TBT24060RE500SW	24773	TBT24060RE500SB	24773	TBT24060RE500EW	24773	TBT24060RE500EB	24773
TBT24054RE500SW	22582	TBT24054RE500SB	22582	TBT24054RE500EW	22582	TBT24054RE500EB	22582
TBT21660RE500SW	22469	TBT21660RE500SB	22469	TBT21660RE500EW	22469	TBT21660RE500EB	22469
TBT21654RE500SW	20517	TBT21654RE500SB	20517	TBT21654RE500EW	20517	TBT21654RE500EB	20517
TBT19254RE500SW	18492	TBT19254RE500SB	18492	TBT19254RE500EW	18492	TBT19254RE500EB	18492
TBT16854RE500SW	16217	TBT16854RE500SB	16217	TBT16854RE500EW	16217	TBT16854RE500EB	16217
TBT14448RE500SW	12894	TBT14448RE500SB	12894	TBT14448RE500EW	12894	TBT14448RE500EB	12894
TBT12048RE500SW	10789	TBT12048RE500SB	10789	TBT12048RE500EW	10789	TBT12048RE500EB	10789
TBT9648RE500SW	9042	TBT9648RE500SB	9042	TBT9648RE500EW	9042	TBT9648RE500EB	9042
TBT8442RE500SW	7109	TBT8442RE500SB	7109	TBT8442RE500EW	7109	TBT8442RE500EB	7109
TBT7236RE500SW	5639	TBT7236RE500SB	5639	TBT7236RE500EW	5639	TBT7236RE500EB	5639

## 2 Select Finish

[Click to view finishes](#)

Finish N/A

Finish N/A

Finish  
N/A

Finish  
N/A

## 3 Select Edge

[Click to view edges](#)



## 4 Select Hardware

[Click to view details](#)

Hardware  
N/A

Hardware  
N/A

Hardware  
N/A

Hardware  
N/A

## Product Features

- Subtop is recessed 3" and edge is finished to match glass
- Glass features flat polished edge
- Custom back painted colors available upon quote
- Glass is 1/2" thick with 1-1/4" subtop

## Notes

- Any Sherwin Williams, Benjamin Moore or Valspar custom back painted glass color is available for a one-time fee per order for \$1475 list.
- DARRAN makes every effort to produce back painted glass with the best available low iron material for color consistency. Low iron glass is a natural material with slight variation from sheet to sheet.

## Seating Accommodations

- 240" seats sixteen to eighteen
- 216" seats twelve to fourteen
- 192" seats ten to twelve
- 168" seats ten
- 144" and 120" seats eight to ten
- 96" and 84" seats eight
- 72" seats six to eight

## Options

### Power

- Add \$125 per power pod when specifying power on a glass conference table top
- REF-310: Reef power unit with daisylink - \$1199 ea
- PD-Cove-PKO: Cove corded series - \$872 ea
- FPDB: Flush power/data bay
  - Hardwired: FPDB-H72: 72" Cord - \$1363. FPDB-H108: 108" Cord - \$1300. FPDB-H144: 144" Cord - \$1350. FPDB-H180: 180" Cord - \$1400.
  - Power/Plug: FPDB-C72: 72" Cord - \$1250. FPDB-C108: 108" Cord - \$1300. FPDB-C144: 144" - Cord \$1350. FPDB-C180: 180" Cord - \$1400

# Conference

Tables  
Arc End

[Click here to view statement of line](#)

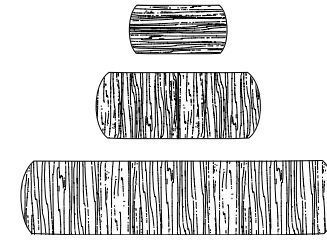

**1 Select Model**

**1 Select Model**

Model	Weight
240 x 60 x 1-1/2"	590
240 x 54 x 1-1/2"	535
<b>2 Piece Top</b>	
216 x 60 x 1-1/2"	535
216 x 54 x 1-1/2"	485
192 x 54 x 1-1/2"	430
168 x 54 x 1-1/2"	310
144 x 48 x 1-1/2"	230
120 x 48 x 1-1/2"	190
<b>1 Piece Top</b>	
96 x 48 x 1-1/2"	150
84 x 42 x 1-1/2"	110
72 x 36 x 1-1/2"	100

	Standard Veneer Top		Premium Veneer Top		High Pressure Laminate Top		Thermally Fused Laminate Top	
	TBT24060AR500W	11887	TBT24060AR500P	13077	TBT24060AR500G	11887	TBT24060AR500M	3806
	TBT24054AR500W	11729	TBT24054AR500P	12902	TBT24054AR500G	11729	TBT24054AR500M	3746
	TBT21660AR500W	10102	TBT21660AR500P	11113	TBT21660AR500G	10102	TBT21660AR500M	3234
	TBT21654AR500W	9978	TBT21654AR500P	10976	TBT21654AR500G	9978	TBT21654AR500M	3190
	TBT19254AR500W	7916	TBT19254AR500P	8709	TBT19254AR500G	7916	TBT19254AR500M	2439
	TBT16854AR500W	7704	TBT16854AR500P	8475	TBT16854AR500G	7704	TBT16854AR500M	2370
	TBT14448AR500W	7026	TBT14448AR500P	7729	TBT14448AR500G	7026	TBT14448AR500M	2160
	TBT12048AR500W	6898	TBT12048AR500P	7589	TBT12048AR500G	6898	TBT12048AR500M	2122
	TBT9648AR500W	3947	TBT9648AR500P	4342	TBT9648AR500G	3947	TBT9648AR500M	1281
	TBT8442AR500W	3813	TBT8442AR500P	4194	TBT8442AR500G	3813	TBT8442AR500M	1144
	TBT7236AR500W	3256	TBT7236AR500P	3583	TBT7236AR500G	3256	TBT7236AR500M	1018

**Product Features**

- WellTech Finish Technology \*Environmental Coatings Technology
- 1-5/16" thick top

**Seating Accommodations**

- 240" seats sixteen to eighteen
- 216" seats twelve to fourteen
- 192" seats ten to twelve
- 168" seats ten
- 144" and 120" seats eight to ten
- 96" and 84" seats eight
- 72" seats six to eight

**Options**

**Power**

- REF-310: Reef power unit with daisylink - \$1199 ea
- PD-Cove-PKO: Cove corded series - \$872 ea
- FPDB: Flush power/data bay
- Hardwired: FPDB-H72: 72" Cord - \$1363. FPDB-H108: 108" Cord - \$1300. FPDB-H144: 144" Cord - \$1350. FPDB-H180: 180" Cord - \$1400.
- Power/Plug: FPDB-C72: 72" Cord - \$1250. FPDB-C108: 108" Cord - \$1300. FPDB-C144: 144" - Cord \$1350. FPDB-C180: 180" Cord - \$1400

**2 Select Finish**

[Click to view finishes](#)

**3 Select Edge**

[Click to view edges](#)

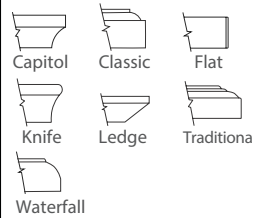
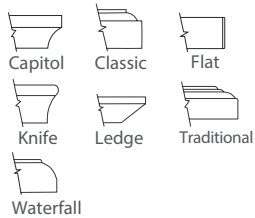

**4 Select Hardware**

[Click to view details](#)

Hardware  
N/A

Hardware  
N/A

Hardware  
N/A

Hardware  
N/A

# Conference

## Glass Tables Arc End

[Click here to view statement of line](#)

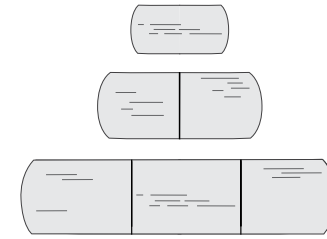

### 1 Select Model

w" x d" x h"	Weight
3 Piece Top	
240 x 60 x 1-1/2"	1245
240 x 54 x 1-1/2"	1125
2 Piece Top	
216 x 60 x 1-1/2"	1125
216 x 54 x 1-1/2"	1015
192 x 54 x 1-1/2"	900
168 x 54 x 1-1/2"	720
144 x 48 x 1-1/2"	545
120 x 48 x 1-1/2"	450
1 Piece Top	
96 x 48 x 1-1/2"	360
84 x 42 x 1-1/2"	270
72 x 36 x 1-1/2"	220

White Glass Gloss Finish		Black Glass Gloss Finish		White Glass SoftEtch ð Finish		Black Glass SoftEtch ð Finish	
TBT24060AR500SW	27083	TBT24060AR500SB	27083	TBT24060AR500EW	27083	TBT24060AR500EB	27083
TBT24054AR500SW	24912	TBT24054AR500SB	24912	TBT24054AR500EW	24912	TBT24054AR500EB	24912
TBT21660AR500SW	24786	TBT21660AR500SB	24786	TBT21660AR500EW	24786	TBT21660AR500EB	24786
TBT21654AR500SW	22476	TBT21654AR500SB	22476	TBT21654AR500EW	22476	TBT21654AR500EB	22476
TBT19254AR500SW	20174	TBT19254AR500SB	20174	TBT19254AR500EW	20174	TBT19254AR500EB	20174
TBT16854AR500SW	17612	TBT16854AR500SB	17612	TBT16854AR500EW	17612	TBT16854AR500EB	17612
TBT14448AR500SW	13787	TBT14448AR500SB	13787	TBT14448AR500EW	13787	TBT14448AR500EB	13787
TBT12048AR500SW	11449	TBT12048AR500SB	11449	TBT12048AR500EW	11449	TBT12048AR500EB	11449
TBT9648AR500SW	9730	TBT9648AR500SB	9730	TBT9648AR500EW	9730	TBT9648AR500EB	9730
TBT8442AR500SW	7551	TBT8442AR500SB	7551	TBT8442AR500EW	7551	TBT8442AR500EB	7551
TBT7236AR500SW	5879	TBT7236AR500SB	5879	TBT7236AR500EW	5879	TBT7236AR500EB	5879

### 2 Select Finish

[Click to view finishes](#)

Finish N/A

Finish N/A

Finish  
N/A

Finish  
N/A

### 3 Select Edge

[Click to view edges](#)



### 4 Select Hardware

[Click to view details](#)

Hardware  
N/A

Hardware  
N/A

Hardware  
N/A

Hardware  
N/A

### Product Features

- Subtop is recessed 3" and edge is finished to match glass
- Glass features flat polished edge
- Custom back painted colors available upon quote
- Glass is 1/2" thick with 1-1/4" subtop

### Notes

- Any Sherwin Williams, Benjamin Moore or Valspar custom back painted glass color is available for a one-time fee per order for \$1475 list.
- DARRAN makes every effort to produce back painted glass with the best available low iron material for color consistency. Low iron glass is a natural material with slight variation from sheet to sheet.

### Seating Accommodations

- 240" seats sixteen to eighteen
- 216" seats twelve to fourteen
- 192" seats ten to twelve
- 168" seats ten
- 144" and 120" seats eight to ten
- 96" and 84" seats eight
- 72" seats six to eight

### Options

#### Power

- Add \$125 per power pod when specifying power on a glass conference table top
- REF-310: Reef power unit with daisylink - \$1199 ea
- PD-Cove-PKO: Cove corded series - \$872 ea
- FPDB: Flush power/data bay
- Hardwired: FPDB-H72: 72" Cord - \$1363. FPDB-H108: 108" Cord - \$1300. FPDB-H144: 144" Cord - \$1350. FPDB-H180: 180" Cord - \$1400.
- Power/Plug: FPDB-C72: 72" Cord - \$1250. FPDB-C108: 108" Cord - \$1300. FPDB-C144: 144" - Cord \$1350. FPDB-C180: 180" Cord - \$1400

# Conference

Tables  
Boat

[Click here to view statement of line](#)

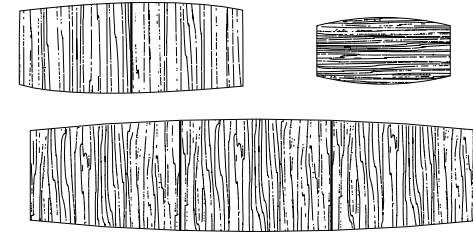

w" x d" x h"  
1 Select Model  
w" x d" x h"

Weight

3 Piece Top	
240 x 60/48 x 1-1/2"	590
240 x 54/42 x 1-1/2"	535
2 Piece Top	
216 x 60/48 x 1-1/2"	535
216 x 54/42 x 1-1/2"	485
192 x 54/42 x 1-1/2"	430
168 x 54 /42 x 1-1/2"	310
144 x 48/39 x 1-1/2"	230
120 x 48/39 x 1-1/2"	190
1 Piece Top	
96 x 48/36 x 1-1/2"	150
84 x 42 /32 x 1-1/2"	120
72 x 36/30 x 1-1/2"	110

	Standard Veneer Top	Premium Veneer Top	High Pressure Laminate Top	Thermally Fused Laminate Top
	TBT24060BT500W 11887	TBT24060BT500P 13077	TBT24060BT500G 11887	TBT24060BT500M 3806
	TBT24054BT500W 11729	TBT24054BT500P 12902	TBT24054BT500G 11729	TBT24054BT500M 3746
	TBT21660BT500W 10102	TBT21660BT500P 11113	TBT21660BT500G 10102	"M" Option N/A
	TBT21654BT500W 9978	TBT21654BT500P 10976	TBT21654BT500G 9978	"M" Option N/A
	TBT19254BT500W 7916	TBT19254BT500P 8709	TBT19254BT500G 7916	TBT19254BT500M 2439
	TBT16854BT500W 7704	TBT16854BT500P 8475	TBT16854BT500G 7704	TBT16854BT500M 2373
	TBT14448BT500W 7026	TBT14448BT500P 7729	TBT14448BT500G 7026	TBT14448BT500M 2160
	TBT12048BT500W 6898	TBT12048BT500P 7589	TBT12048BT500G 6898	TBT12048BT500M 2122
	TBT9648BT500W 3947	TBT9648BT500P 4342	TBT9648BT500G 3947	TBT9648BT500M 1281
	TBT8442BT500W 3813	TBT8442BT500P 4194	TBT8442BT500G 3813	TBT8442BT500M 1144
	TBT7236BT500W 3256	TBT7236BT500P 3583	TBT7236BT500G 3256	TBT7236BT500M 1018

2 Select Finish  
[Click to view finishes](#)

3 Select Edge  
[Click to view edges](#)

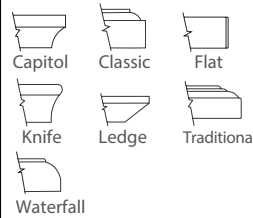
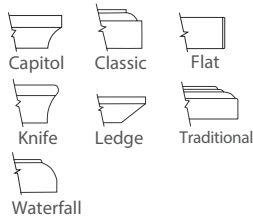

4 Select Hardware  
[Click to view details](#)

Hardware  
N/A

Hardware  
N/A

Hardware  
N/A

Hardware  
N/A

## Product Features

- WellTech Finish Technology \*Environmental Coatings Technology
- 1-5/16" thick top

### Seating Accommodations

- 240" seats sixteen to eighteen
- 216" seats twelve to fourteen
- 192" seats ten to twelve
- 168" seats ten
- 144" and 120" seats eight to ten
- 96" and 84" seats eight
- 72" seats six

## Options

### Power

- REF-310: Reef power unit with daisylink - \$1199 ea
- PD-Cove-PKO: Cove corded series - \$872 ea
- FPDB: Flush power/data bay
- Hardwired: FPDB-H72: 72" Cord - \$1363. FPDB-H108: 108" Cord - \$1300. FPDB-H144: 144" Cord - \$1350. FPDB-H180: 180" Cord - \$1400.
- Power/Plug: FPDB-C72: 72" Cord - \$1250. FPDB-C108: 108" Cord - \$1300. FPDB-C144: 144" - Cord \$1350. FPDB-C180: 180" Cord - \$1400

# Conference

## Glass Tables

### Boat

[Click here to view statement of line](#)

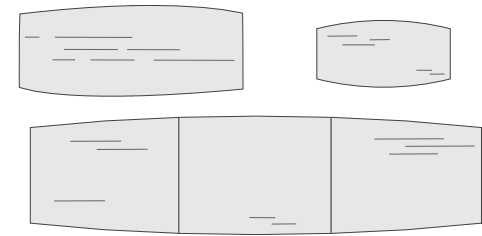

#### 1 Select Model

w" x d" x h"

3 Piece Top

240 x 60/48 x 1-1/2"

Weight

1245

240 x 54/42 x 1-1/2"

1125

2 Piece Top

216 x 60/48 x 1-1/2"

1125

216 x 54/42 x 1-1/2"

1015

192 x 54/42 x 1-1/2"

900

168 x 54 /42 x 1-1/2"

720

144 x 48/39 x 1-1/2"

545

120 x 48/39 x 1-1/2"

450

1 Piece Top

96 x 48/36 x 1-1/2"

360

84 x 42 /32 x 1-1/2"

270

72 x 36/30 x 1-1/2"

220

		White Glass Gloss Finish		Black Glass Gloss Finish		White Glass SoftEtch ð Finish		Black Glass SoftEtch ð Finish	
		TBT24060BT500SW	27083	TBT24060BT500SB	27083	TBT24060BT500EW	27083	TBT24060BT500EB	27083
		TBT24054BT500SW	24912	TBT24054BT500SB	24912	TBT24054BT500EW	24912	TBT24054BT500EB	24912
		TBT21660BT500SW	24786	TBT21660BT500SB	24786	TBT21660BT500EW	24786	TBT21660BT500EB	24786
		TBT21654BT500SW	22476	TBT21654BT500SB	22476	TBT21654BT500EW	22476	TBT21654BT500EB	22476
		TBT19254BT500SW	20174	TBT19254BT500SB	20174	TBT19254BT500EW	20174	TBT19254BT500EB	20174
		TBT16854BT500SW	17612	TBT16854BT500SB	17612	TBT16854BT500EW	17612	TBT16854BT500EB	17612
		TBT14448BT500SW	13787	TBT14448BT500SB	13787	TBT14448BT500EW	13787	TBT14448BT500EB	13787
		TBT12048BT500SW	11449	TBT12048BT500SB	11449	TBT12048BT500EW	11449	TBT12048BT500EB	11449
		TBT9648BT500SW	9730	TBT9648BT500SB	9730	TBT9648BT500EW	9730	TBT9648BT500EB	9730
		TBT8442BT500SW	7551	TBT8442BT500SB	7551	TBT8442BT500EW	7551	TBT8442BT500EB	7551
		TBT7236BT500SW	5879	TBT7236BT500SB	5879	TBT7236BT500EW	5879	TBT7236BT500EB	5879

#### 2 Select Finish

[Click to view finishes](#)

Finish N/A

Finish N/A

Finish  
N/A

Finish  
N/A

#### 3 Select Edge

[Click to view edges](#)



Infinity



Infinity



Infinity



Infinity

#### 4 Select Hardware

[Click to view details](#)

Hardware  
N/A

Hardware  
N/A

Hardware  
N/A

Hardware  
N/A

#### Product Features

- Subtop is recessed 3" and edge is finished to match glass
- Glass features flat polished edge
- Custom back painted colors available upon quote
- Glass is 1/2" thick with 1-1/4" subtop

#### Notes

- Any Sherwin Williams, Benjamin Moore or Valspar custom back painted glass color is available for a one-time fee per order for \$1475 list.
- DARRAN makes every effort to produce back painted glass with the best available low iron material for color consistency. Low iron glass is a natural material with slight variation from sheet to sheet.

#### Seating Accommodations

- 240" seats sixteen to eighteen
- 216" seats twelve to fourteen
- 192" seats ten to twelve
- 168" seats ten
- 144" and 120" seats eight to ten
- 96" and 84" seats eight
- 72" seats six

#### Options

##### Power

- Add \$125 per power pod when specifying power on a glass conference table top
- REF-310: Reef power unit with daisylink - \$1199 ea
- PD-Cove-PKO: Cove corded series - \$872 ea
- FPDB: Flush power/data bay
- Hardwired: FPDB-H72: 72" Cord - \$1363. FPDB-H108: 108" Cord - \$1300. FPDB-H144: 144" Cord - \$1350. FPDB-H180: 180" Cord - \$1400.
- Power/Plug: FPDB-C72: 72" Cord - \$1250. FPDB-C108: 108" Cord - \$1300. FPDB-C144: 144" - Cord \$1350. FPDB-C180: 180" Cord - \$1400

# Conference

## Telecom Tables Wedge

[Click here to view statement of line](#)

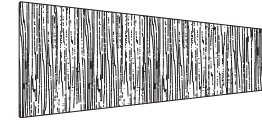
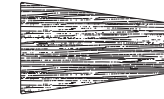

### 1 Select Model

w" x d" x h"

2 Piece

144 x 60/30

132 x 60/30

120 x 54/30

1 Piece

108 x 54/30

96 x 51/30

84 x 48/30

72 x 42/28

Weight

		Standard Veneer Top		Premium Veneer Top		High Pressure Laminate Top		Thermally Fused Laminate Top	
250	TBT14460WE400W	7704	TBT14460WE400P	8475	TBT14460WE400G	7704	TBT14460WE400M	2889	
235	TBT13260WE400W	7458	TBT13260WE400P	8204	TBT13260WE400G	7458	TBT13260WE400M	2653	
215	TBT12054WE400W	7082	TBT12054WE400P	7791	TBT12054WE400G	7082	TBT12054WE400M	2297	
195	TBT10854WE400W	4633	TBT10854WE400P	5097	TBT10854WE400G	4633	TBT10854WE400M	2122	
170	TBT9651WE400W	4025	TBT9651WE400P	4427	TBT9651WE400G	4025	TBT9651WE400M	1353	
135	TBT8448WE400W	3889	TBT8448WE400P	4278	TBT8448WE400G	3889	TBT8448WE400M	1217	
105	TBT7242WE400W	3329	TBT7242WE400P	3662	TBT7242WE400G	3329	TBT7242WE400M	1089	

### Product Features

- Tops and bases are pre-mounted to ensure proper installation location
- 1-5/16" thick top

### Seating Accommodations

- 144" and 120" seats eight to ten
- 132" and 120" seats eight to ten
- 108", 96" and 84" seats eight
- 72" seats four to five

### 2 Select Finish

[Click to view finishes](#)

### 3 Select Edge

[Click to view edges](#)

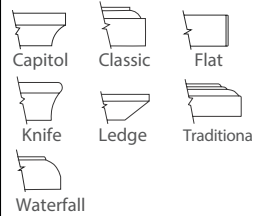
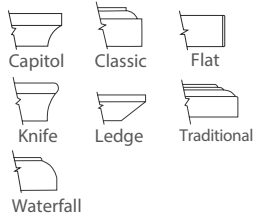

### 4 Select Hardware

[Click to view details](#)

Hardware  
N/A

Hardware  
N/A

Hardware  
N/A

Hardware  
N/A



# Conference

Drum Bases  
Wood Drum

[Click here to view statement of line](#)

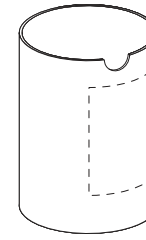

## 1 Select Model

w" x d" x h"  
For Tops Over 48" W  
24 DIA x 28.75  
For tops 42" - 48" W  
20 DIA x 28.75  
For tops less than 42" W  
16 DIA x 28.75

Weight

	Standard Veneer	Premium Veneer	High Pressure Laminate	Thermally Fused Laminate
100	TBB2424WD969W 2007	TBB2424WD969P 2208	"G" Option N/A	"M" Option N/A
75	TBB2020WD969W 1906	TBB2020WD969P 2098	"G" Option N/A	"M" Option N/A
60	TBB1616WD969W 1806	TBB1616WD969P 1987	"G" Option N/A	"M" Option N/A

## Product Features

- Wire access door and open top and bottom allowing easy wire access
- All finishes are a stain match on maple or oak veneer

## Notes

- Drum bases can be used as center supports
- See base matrix to determine bases for specified top
- On round and square top base ships with weights to prevent tipping

## 2 Select Finish

[Click to view finishes](#)

## 3 Select Edge

[Click to view edges](#)

Edge  
N/A

Edge  
N/A

## 4 Select Hardware

[Click to view details](#)

Hardware  
N/A

Hardware  
N/A

# Conference

Drum Bases  
Half Wood Drum

[Click here to view statement of line](#)

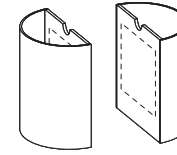

Drum bases can be used as center supports



## 1 Select Model

w" x d" x h"  
For Tops Over 48" W  
24 x 12 x 28.75  
For tops 42" - 48" W  
20 x 10 x 28.75  
For tops less than 42" W  
16 x 8 x 28.75

Weight

	Standard Veneer	Premium Veneer	High Pressure Laminate	Thermally Fused Laminate
75	TBB2412HD968W 1921	TBB2412HD968P 2113	"G" Option N/A	"M" Option N/A
60	TBB2010HD968W 1820	TBB2010HD968P 2002	"G" Option N/A	"M" Option N/A
50	TBB1608HD968W 1720	TBB1608HD968P 1893	"G" Option N/A	"M" Option N/A

## 2 Select Finish

[Click to view finishes](#)

## 3 Select Edge

[Click to view edges](#)

Edge  
N/A

Edge  
N/A

## 4 Select Hardware

[Click to view details](#)

Hardware  
N/A

Hardware  
N/A

## Product Features

- Wire access door and open top and bottom allowing easy wire access
- All finishes are a stain match on maple or oak veneer

## Notes

- Box bases can be used as center supports
- See base matrix to determine bases for specified top
- On round and square top base ships with weights to prevent tipping

Conference  
 Drum Bases  
 Transitional Wood Cylinder Base

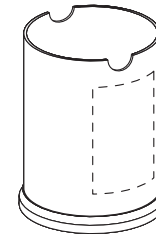

[Click here to view statement of line](#)

1 Select Model

w" x d" x h"  
 For Tops Over 48" W  
 24 DIA x 28.75  
 For tops 42" - 48" W  
 20 DIA x 28.75  
 For tops less than 42" W  
 16 DIA x 28.75

Weight

		Standard Veneer	Premium Veneer	High Pressure Laminate	Thermally Fused Laminate
70	TBB2424TC969W 2278	"P" Option N/A	"G" Option N/A	"M" Option N/A	
65	TBB2020TC969W 2142	"P" Option N/A	"G" Option N/A	"M" Option N/A	
60	TBB1616TC969W 2007	"P" Option N/A	"G" Option N/A	"M" Option N/A	

Product Features

- Wire access door and open top and bottom allowing easy wire access
- All finishes are a stain match on maple veneer

Notes

- Drum bases can be used as center supports
- See base matrix to determine bases for specified top
- On round and square top base ships with weights to prevent tipping

2 Select Finish

[Click to view finishes](#)

3 Select Edge

[Click to view edges](#)

Edge  
N/A

Edge  
N/A

4 Select Hardware

[Click to view details](#)

Hardware  
N/A

Hardware  
N/A

# Conference

Traditional Drum Bases  
Traditional Drum

[Click here to view statement of line](#)



## 1 Select Model

w" x d" x h"  
For Tops Over 48" W  
24 DIA x 28.75  
For tops 42" - 48" W  
20 DIA x 28.75  
For tops 42" or less  
16 DIA x 28.75

Weight

	Standard Veneer	Premium Veneer	High Pressure Laminate	Thermally Fused Laminate
115	TBB2424TD969W 2278	"P" Option N/A	"G" Option N/A	"M" Option N/A
90	TBB2020TD969W 2142	"P" Option N/A	"G" Option N/A	"M" Option N/A
75	TBB1616TD969W 2007	"P" Option N/A	"G" Option N/A	"M" Option N/A

## Product Features

- 2.625" base w/ classic profile
- Beltline moldings
- Plywood drum
- Wire access door and open top and bottom allowing easy wire access
- All finishes are a stain match on maple veneer

## Notes

- Drum bases can be used as center supports
- See base matrix to determine bases for specified top
- On round and square top base ships with weights to prevent tipping

## 2 Select Finish

[Click to view finishes](#)

## 3 Select Edge

[Click to view edges](#)

Edge  
N/A

## 4 Select Hardware

[Click to view details](#)

Hardware  
N/A

# Conference

Cube Bases

Contemporary Cube Base

[Click here to view statement of line](#)

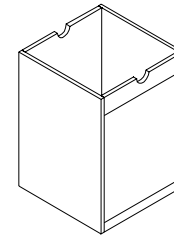

## 1 Select Model

w" x d" x h"  
 For Tops Over 48" W  
 24 x 24 x 28.75  
 For tops 42" - 48" W  
 20 x 20 x 28.75  
 For tops less than 42" W  
 16 x 16 x 28.75

Weight

	Standard Veneer	Premium Veneer	High Pressure Laminate	Thermally Fused Laminate
85	TBB2424CC962W 1477	TBB2424CC962P 1624	"G" Option N/A	TBB2424CC962M 1146
70	TBB2020CC962W 1406	TBB2020CC962P 1546	"G" Option N/A	TBB2020CC962M 1095
60	TBB1616CC962W 1333	TBB1616CC962P 1467	"G" Option N/A	TBB1616CC962M 1048

## Product Features

- 2 x 4 grommet cutout
- Open top and bottom

## Notes

- Access door standard
- See base matrix to determine bases for specified top

## 2 Select Finish

[Click to view finishes](#)

## 3 Select Edge

[Click to view edges](#)

Edge  
N/A

Edge  
N/A

Edge  
N/A

## 4 Select Hardware

[Click to view details](#)

Hardware  
N/A

Hardware  
N/A

Hardware  
N/A

# Conference

Cube Bases

Contemporary Half Cube

[Click here to view statement of line](#)

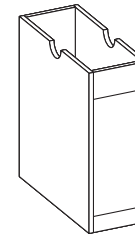

### 1 Select Model

- w" x d" x h"
- For Tops Over 48" W
- 24 x 10 x 28.75
- For tops 42" - 48" W
- 20 x 10 x 28.75
- For tops less than 42" W
- 16 x 10 x 28.75

Weight	Standard Veneer		Premium Veneer		High Pressure Laminate	Thermally Fused Laminate	
40	TBB2410CH977W	1312	TBB2410CH977P	1444	"G" Option N/A	TBB2410CH977M	1019
30	TBB2010CH977W	1201	TBB2010CH977P	1375	"G" Option N/A	TBB2010CH977M	937
20	TBB1610CH977W	1184	TBB1610CH977P	1303	"G" Option N/A	TBB1610CH977M	932

### Product Features

- 2 x 4 grommet cutout
- Open top and bottom

### Notes

- Access door standard
- See base matrix to determine bases for specified top

### 2 Select Finish

[Click to view finishes](#)

### 3 Select Edge

[Click to view edges](#)

Edge  
N/A

Edge  
N/A

Edge  
N/A

### 4 Select Hardware

[Click to view details](#)

Hardware  
N/A

Hardware  
N/A

Hardware  
N/A

# Conference

Cube Bases

Contemporary Cube W/ Metal Detail

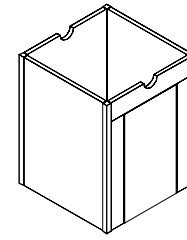

[Click here to view statement of line](#)

## 1 Select Model

w" x d" x h"  
 For Tops Over 48" W  
 24 x 24 x 28.75  
 For Tops 42" - 48" W  
 20 x 20 x 28.75  
 For tops less than 42" W  
 16 x 16 x 28.75

Weight	Standard Veneer		Premium Veneer		High Pressure Laminate	Thermally Fused Laminate	
110	TBB2424CS962W	2258	TBB2424CS962P	2484	"G" Option N/A	TBB2424CS962M	1762
85	TBB2020CS962W	2108	TBB2020CS962P	2319	"G" Option N/A	TBB2020CS962M	1642
70	TBB1616CS962W	1956	TBB1616CS962P	2152	"G" Option N/A	TBB1616CS962M	1527

## Product Features

- 2 x 4 grommet cutout
- Adjustable glides
- Anodized aluminum metal feet

## Notes

- Access door
- See base matrix to determine bases for specified top

## 2 Select Finish

[Click to view finishes](#)

## 3 Select Edge

[Click to view edges](#)

Edge  
N/A

Edge  
N/A

Edge  
N/A

## 4 Select Hardware

[Click to view details](#)

Hardware  
N/A

Hardware  
N/A

Hardware  
N/A

**Conference**  
 Cube Post Bases  
 Contemporary Half Cube With Metal Detail

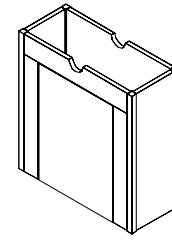

[Click here to view statement of line](#)

**1 Select Model**

- w" x d" x h"  
 For Tops Over 48" W  
 24 x 10 x 28.75  
 For tops 42" - 48" W  
 20 x 10 x 28.75  
 For tops less than 42" W  
 16 x 10 x 28.75

Weight	Standard Veneer		Premium Veneer		High Pressure Laminate	Thermally Fused Laminate	
85	TBB2410HS975W	2085	TBB2410HS975P	2294	"G" Option N/A	TBB2410HS975M	1629
65	TBB2010HS975W	1972	TBB2010HS975P	2169	"G" Option N/A	TBB2010HS975M	1542
45	TBB1610HS975W	1856	TBB1610HS975P	2043	"G" Option N/A	TBB1610HS975M	1450

**Product Features**

- 2 x 4 grommet cutout
- Open top and bottom
- Metal details on each corner anodized aluminum

**Notes**

- Access door
- See base matrix to determine bases for specified top

**2 Select Finish**

[Click to view finishes](#)

**3 Select Edge**

[Click to view edges](#)

Edge  
N/A

Edge  
N/A

Edge  
N/A

**4 Select Hardware**

[Click to view details](#)

Hardware  
N/A

Hardware  
N/A

Hardware  
N/A



# Conference

Cube Bases  
Transitional Cube

[Click here to view statement of line](#)

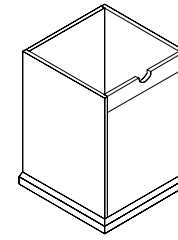

## 1 Select Model

w" x d" x h"  
For Tops Over 48" W  
24 x 24 x 28.75  
For tops 42" - 48" W  
20 x 20 x 28.75  
For tops less than 42" W  
16 x 16 x 28.75

Weight

	Standard Veneer	Premium Veneer	High Pressure Laminate	Thermally Fused Laminate
85	TBB2424TR962W 1697	"P" Option N/A	"G" Option N/A	"M" Option N/A
70	TBB2020TR962W 1578	"P" Option N/A	"G" Option N/A	"M" Option N/A
60	TBB1616TR962W 1455	"P" Option N/A	"G" Option N/A	"M" Option N/A

## Product Features

- Open top and bottom
- Transitional - Hardwood base 2 1/2" H

## Notes

- Access door
- See base matrix to determine bases for specified top

## 2 Select Finish

[Click to view finishes](#)

## 3 Select Edge

[Click to view edges](#)

Edge  
N/A

## 4 Select Hardware

[Click to view details](#)

Hardware  
N/A

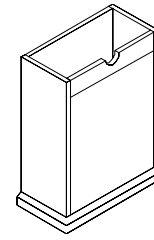

[Click here to view statement of line](#)

Standard Veneer	Premium Veneer	High Pressure Laminate	Thermally Fused Laminate
-----------------	----------------	------------------------	--------------------------

**2 Select Finish**  
[Click to view finishes](#)

**3 Select Edge**  
[Click to view edges](#)

Edge  
N/A

**4 Select Hardware**  
[Click to view details](#)

Hardware  
N/A

# Conference

Traditional Cube Bases  
Full Traditional Cabinet Bases

[Click here to view statement of line](#)

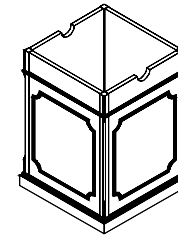

## 1 Select Model

w" x d" x h"  
For Tops Over 48" W  
24 x 24 x 28.75  
For tops 42" - 48" W  
20 x 20 x 28.75  
For tops less than 42" W  
16 x 16 x 28.75

Weight

	Standard Veneer	Premium Veneer	High Pressure Laminate	Thermally Fused Laminate
115	TBB2424TC962W 2351	"P" Option N/A	"G" Option N/A	"M" Option N/A
90	TBB2020TC962W 2173	"P" Option N/A	"G" Option N/A	"M" Option N/A
75	TBB1616TC962W 1992	"P" Option N/A	"G" Option N/A	"M" Option N/A

## Product Features

- 2 x 4 grommet cutout
- Hardwood beltline molding
- Hardwood corner post and base
- Molding
- Open bottom

## Notes

- Access door
- See base matrix to determine bases for specified top

## Options

- Molding
- DSM2: Delete panel molding - Deduct \$50

## 2 Select Finish

[Click to view finishes](#)

## 3 Select Edge

[Click to view edges](#)

Edge  
N/A

## 4 Select Hardware

[Click to view details](#)

Hardware  
N/A

# Conference

Traditional Cube Bases  
Half Traditional Cabinet Base

[Click here to view statement of line](#)

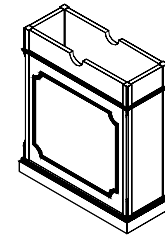

## 1 Select Model

w" x d" x h"  
For Tops Over 48" W  
24 x 10 x 28.75  
For tops 42" - 48" W  
20 x 10 x 28.75  
For tops less than 42" W  
16 x 10 x 28.75

Weight

	Standard Veneer	Premium Veneer	High Pressure Laminate	Thermally Fused Laminate
90	TBB2410TH977W 1898	"P" Option N/A	"G" Option N/A	"M" Option N/A
70	TBB2010TH977W 1798	"P" Option N/A	"G" Option N/A	"M" Option N/A
50	TBB1610TH977W 1713	"P" Option N/A	"G" Option N/A	"M" Option N/A

## Product Features

- 2 x 4 grommet cutout
- Hardwood beltline molding
- Hardwood corner post and base
- Molding
- Open bottom

## Notes

- Access door
- See base matrix to determine bases for specified top

## Options

- Molding
- DSM2: Delete panel molding - Deduct \$50

## 2 Select Finish

[Click to view finishes](#)

## 3 Select Edge

[Click to view edges](#)

Edge  
N/A

## 4 Select Hardware

[Click to view details](#)

Hardware  
N/A

# Conference

Modesty Trough / Tray Bases  
4 3/4" H Wire Trough Modesty

[Click here to view statement of line](#)

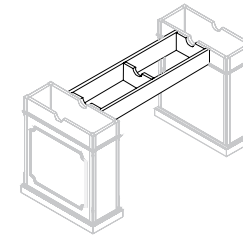

## 1 Select Model

w" x d" x h"

Weight

Required Trough Modesty for Top Sizes:

		Standard Veneer	Premium Veneer	High Pressure Laminate	Thermally Fused Laminate
240"	90	WT04-240W 3428	WT04-240P 3771	"G" Option N/A	WT04-240M 2399
216"	100	WT04-216W 3234	WT04-216P 3559	"G" Option N/A	WT04-216M 2264
Required Trough Modesty for Top Sizes:					
192"	210	WT04-192W 2904	WT04-192P 3195	"G" Option N/A	WT04-192M 2128
168"	190	WT04-168W 2718	WT04-168P 2990	"G" Option N/A	WT04-168M 1992
144"	170	WT04-144W 2529	WT04-144P 2782	"G" Option N/A	WT04-144M 1856
Required Trough Modesty for Top Sizes:					
120"	110	WT04-120W 1465	WT04-120P 1612	"G" Option N/A	WT04-120M 1076
96"	100	WT04-96W 1279	WT04-96P 1407	"G" Option N/A	WT04-96M 940
84"	95	WT04-84W 1091	WT04-84P 1201	"G" Option N/A	WT04-84M 803

## Product Features

- Open Bottom
- Wire grommets and channels

## Notes

- Actual dimension is 4 3/4"
- Interior base molding will be deleted on Traditional bases.
- Must order bases separately. Bases and Rack shipped separately. Requires assembly.
- Trough can be used on both contemporary and traditional bases

## 2 Select Finish

[Click to view finishes](#)

## 3 Select Edge

[Click to view edges](#)

Edge  
N/A

Edge  
N/A

Edge  
N/A

## 4 Select Hardware

[Click to view details](#)

Hardware  
N/A

Hardware  
N/A

Hardware  
N/A

## Conference

Panel Base W/ Wire Management Modesty  
Panel Base

[Click here to view statement of line](#)

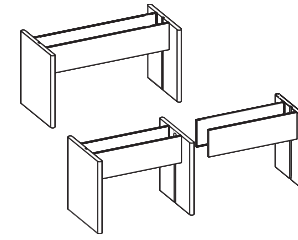

### 1 Select Model

w" x d" x h"

3 Panel Base for Tables

Weight	Model	Standard Veneer	Premium Veneer	High Pressure Laminate	Thermally Fused Laminate
240"	205	TBB20424PB972W 7202	TBB20424PB972P 7924	"G" Option N/A	"M" Option N/A
216"	190	TBB18024PB972W 6629	TBB18024PB972P 7291	"G" Option N/A	"M" Option N/A
192"	175	TBB15624PB972W 6057	TBB15624PB972P 6664	"G" Option N/A	"M" Option N/A
168"	160	TBB13224PB972W 5485	TBB13224PB972P 6033	"G" Option N/A	"M" Option N/A
144"	150	TBB10824PB972W 4911	TBB10824PB972P 5403	"G" Option N/A	"M" Option N/A

2 Panel Base for Tables

120"	100	TBB8424PB972W 3224	TBB8424PB972P 3688	"G" Option N/A	"M" Option N/A
96"	100	TBB6024PB972W 2638	TBB6024PB972P 3018	"G" Option N/A	"M" Option N/A
84"	100	TBB5424PB972W 2672	TBB5424PB972P 2939	"G" Option N/A	"M" Option N/A

### 2 Select Finish

[Click to view finishes](#)

### 3 Select Edge

[Click to view edges](#)

Edge  
N/A

Edge  
N/A

Edge  
N/A

### 4 Select Hardware

[Click to view details](#)

Hardware  
N/A

Hardware  
N/A

Hardware  
N/A

### Product Features

- 1.3125" thick end panels
- 3mm wood bands
- Anti-glide tearout band
- Wire management channels
- Wire trough modesty

### Notes

- 2 panel base Factory assembled
- 3 panels - shipped 2 sections
- Base height: 28.75"H

# Conference

## Panel Base W/ Wire Management Modesty Traditional Panel Base

[Click here to view statement of line](#)

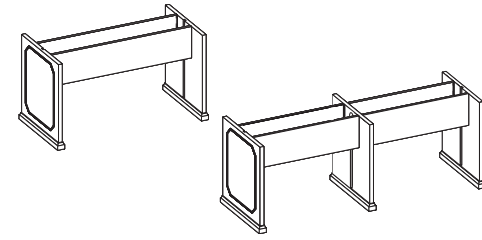

### 1 Select Model

w" x d" x h"

3 Panel Base for Tables

Weight	Model	SKU
240"	TBB20424TB972W	7921
216"	TBB18024TB972W	7290
192"	TBB15624TB972W	6664
168"	TBB13224TB972W	6033
144"	TBB10824TB972W	5403

2 Panel Base for Tables

120"	TBB8424TB972W	3687
96"	TBB6024TB972W	3019
84"	TBB5424TB972W	2941

Standard Veneer	Premium Veneer	High Pressure Laminate	Thermally Fused Laminate
	"P" Option N/A	"G" Option N/A	"M" Option N/A
	"P" Option N/A	"G" Option N/A	"M" Option N/A
	"P" Option N/A	"G" Option N/A	"M" Option N/A
	"P" Option N/A	"G" Option N/A	"M" Option N/A
	"P" Option N/A	"G" Option N/A	"M" Option N/A
	"P" Option N/A	"G" Option N/A	"M" Option N/A
	"P" Option N/A	"G" Option N/A	"M" Option N/A
	"P" Option N/A	"G" Option N/A	"M" Option N/A

### Product Features

- 1.3125" thick end panels
- 2.125" x 2" hardwood base
- 3mm wood bands
- Scalloped moldings
- Wire management channels
- Wire trough modesty

### Notes

- Base Height: 28.75"H

### Options

- Molding Panel
- DSM2: Delete panel molding - Deduct \$50

### 2 Select Finish

[Click to view finishes](#)

### 3 Select Edge

[Click to view edges](#)

Edge  
N/A

### 4 Select Hardware

[Click to view details](#)

Hardware  
N/A

# Conference

Panel Pedestal Bases  
Panel X Base

[Click here to view statement of line](#)

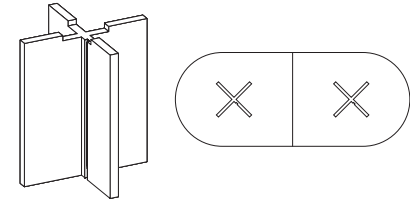

## 1 Select Model

w" x d" x h"  
For Tops 60" W and 54" DIA  
30 x 30 x 28.75 65  
For Tops 48" - 54" W and 42" - 48" DIA  
24 x 24 x 28.75 55  
For tops 36" - 42" W (N/A on round tables)  
18 x 18 x 28.75 45

Weight

Standard Veneer	Premium Veneer	High Pressure Laminate	Thermally Fused Laminate
TBB3030PX966W 1835	TBB3030PX966P 2019	"G" Option N/A	TBB3030PX966M 1283
TBB2424PX966W 1720	TBB2424PX966P 1893	"G" Option N/A	TBB2424PX966M 1204
TBB1818PX966W 1605	TBB1818PX966P 1766	"G" Option N/A	TBB1818PX966M 1139

## Product Features

- 1.3125 thick end panels with 3mm wood bands

## Notes

- Panel x base can be used as center support with Panel T base on 2 pc tops.  
- See base matrix to determine bases for specified top

## 2 Select Finish

[Click to view finishes](#)

## 3 Select Edge

[Click to view edges](#)

Edge  
N/A

Edge  
N/A

Edge  
N/A

## 4 Select Hardware

[Click to view details](#)

Hardware  
N/A

Hardware  
N/A

Hardware  
N/A



# Conference

Panel Pedestal Bases

Panel T Base

[Click here to view statement of line](#)

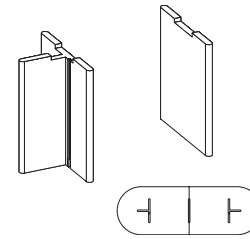

1 Select Model  
w" x d" x h"

Weight

Standard Veneer	Premium Veneer	High Pressure Laminate	Thermally Fused Laminate
-----------------	----------------	------------------------	--------------------------

2 Select Finish  
Click to view finishes

3 Select Edge  
Click to view edges

Edge  
N/A

Edge  
N/A

Edge  
N/A

4 Select Hardware  
Click to view details

Hardware  
N/A

Hardware  
N/A

Hardware  
N/A

# Conference

Traditional Bases  
 Traditional Duncan Phyfe Pedestal Base

[Click here to view statement of line](#)

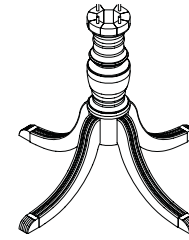

## 1 Select Model

w" x d" x h"

31 x 31 x 29.5

Weight

35

Standard Veneer	Premium Veneer	High Pressure Laminate	Thermally Fused Laminate
TBB3131PB955W 2272	"P" Option N/A	"G" Option N/A	"M" Option N/A

## Product Features

- 5 3/4" DIA column
- 13 1/2" Curve leg 12" High
- 24" DIA Sub top bolted to top of column (for attachment to top)

## Options

- Premium Metal Finishes
- Specify metal toe cap finish
  - ABT: Antique Brass Standard toe cap finish. Optional finish BPT: Brushed Pewter - n/c

## 2 Select Finish

[Click to view finishes](#)

Metal toe cap finish

ABT Antique Brass,  
 BPT Pewter

## 3 Select Edge

[Click to view edges](#)

Edge  
 N/A

## 4 Select Hardware

[Click to view details](#)

Hardware  
 N/A

# Conference

Metal Bases

Column "X" Series

[Click here to view statement of line](#)

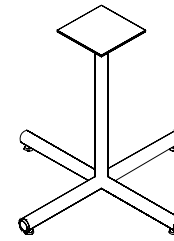

## 1 Select Model

w" x d" x h"

36 x 36 x 27.75

32 x 32 x 27.75

Weight

35

30

Silver Metal Base

TBB3636MB971	710
TBB3232MB971	658

## Product Features

- Standard Silver base (optional Black)
- Available with casters

## Options

Casters

- CAS20L: Casters - \$200 per base

Premium Finish Option

- MFB: Black Metal Finish - \$100

## 2 Select Finish

[Click to view finishes](#)

MFS

Metal Finish

MFS Silver. Additional

Metal Finishes are available, options

## 3 Select Edge

[Click to view edges](#)

Edge  
N/A

## 4 Select Hardware

[Click to view details](#)

Hardware  
N/A

# Conference

Metal Bases

Metal Column T-Leg

[Click here to view statement of line](#)

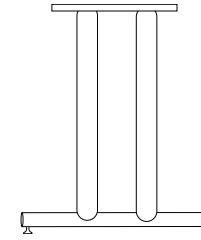

## 1 Select Model

- w" x d" x h"
- Single column T-leg
- 30 x 2 x 27.75
- Double column T-leg
- 26 x 2 x 27.75
- 36 x 2 x 27.75
- 42 x 2 x 27.75
- 42 x 3 x 27.75

Weight

Silver Metal Base			
20	TBB3002MB956	592	
20	TBB2602MB956	592	
25	TBB3602MB956	634	
30	TBB4202MB956	662	
30	TBB4203MB956	806	

## Product Features

- Available with casters. See notes
- Recommended Top Size 36" D - 60" D
- Standard Silver base (optional Black)

## Notes

- Casters not available for TBB3002MB956 and TBB4203MB956

## Options

Casters

- CAS20L: Casters - \$100 per base

Premium Finish Option

- MFB: Black Metal Finish - n/c

## 2 Select Finish

[Click to view finishes](#)

MFS

Metal Finish

MFS Silver. Additional

Metal Finishes are available, options

## 3 Select Edge

[Click to view edges](#)

Edge  
N/A

## 4 Select Hardware

[Click to view details](#)

Hardware  
N/A

# Conference

Metal Bases

Metal Leg - Kd

[Click here to view statement of line](#)

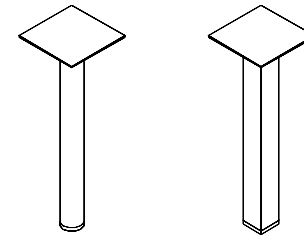

## 1 Select Model

w" x d" x h"

Round Leg

3 dia. x 27.75

Square Leg

2.4 x 2.4 x 27.75

Weight

15

15

Silver Metal Base

TBB0303MB982 310

TBB0303MB976 310

## Product Features

- Available with casters
- Standard Silver base (optional Black)

## Options

Casters

- CAS20L: Casters - \$100 per base

Premium Finish Option

- MFB: Black Metal Finish - \$100

## 2 Select Finish

[Click to view finishes](#)

## 3 Select Edge

[Click to view edges](#)

Edge  
N/A

## 4 Select Hardware

[Click to view details](#)

Hardware  
N/A

# Conference

Metal Bases

Tapered Metal Leg



[Click here to view statement of line](#)

## 1 Select Model

w" x d" x h"  
2.375 x 1 x 28

Weight  
15

Silver Metal Base	
TBB0301MB985	350

## Product Features

- Standard Silver base (optional Black)

## Options

Premium Finish Option  
 - Specify base Metal Finish color - \$160 per base  
 - MFB: Black, MFW: White

## 2 Select Finish

[Click to view finishes](#)

## 3 Select Edge

[Click to view edges](#)

Edge  
N/A

## 4 Select Hardware

[Click to view details](#)

Hardware  
N/A

# Conference

Metal Bases

Metal Angled Sleigh Base

[Click here to view statement of line](#)

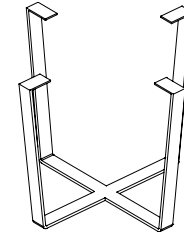

## 1 Select Model

w" x d" x h"  
36 x 36 x 28.5

Weight

65

Silver Metal Base

TBB3030MB984 1695

## 2 Select Finish

[Click to view finishes](#)

## 3 Select Edge

[Click to view edges](#)

Edge  
N/A

## 4 Select Hardware

[Click to view details](#)

Hardware  
N/A

## Product Features

- Standard Silver base (optional White, Black)

## Notes

- Cannot be used on tops less than 42" depth recommended for tops 48" or greater

## Options

Premium Finish Option

- Specify base Metal Finish color - \$160 per base

- MFB: Black, MFW: White

# Conference - Central Park

Central Park Base  
Single Metal "U" Shaped Leg

[Click here to view statement of line](#)

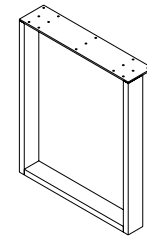

## 1 Select Model

w" x d" x h"	Weight
24 x 3 x 27.75	30
30 x 3 x 27.75	40
36 x 3 x 27.75	50

Metal Base				
TBB2403MB954	778			
TBB3003MB954	841			
TBB3603MB954	905			

## Product Features

- Standard black or silver base (optional white)

## Options

### Premium Finish Option

- Specify leg Metal Finish color - \$100 per leg
- MFW: White

### Wire Management

- W17: Wire management cover - \$80

Attaches to the leg by magnets

## 2 Select Finish

[Click to view finishes](#)

## 3 Select Edge

[Click to view edges](#)

Edge  
N/A

## 4 Select Hardware

[Click to view details](#)

Hardware  
N/A



Conference  
 Conferencing Legs  
 Single Metal Leg

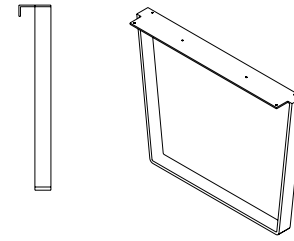

[Click here to view statement of line](#)

1 Select Model

w" x d" x h"	Weight
36 x 3 x 27.75	50
30 x 3 x 27.75	40

Silver Metal Base				
NSS3603MB988	833	"P" Option N/A	"G" Option N/A	"M" Option N/A
NSS3003MB988	803	"P" Option N/A	"G" Option N/A	"M" Option N/A
Edge N/A	Edge N/A	Edge N/A	Edge N/A	Edge N/A
Hardware N/A				

Product Features

- Legs have been laser cut and bent to create unique not so square shape
- Standard Silver base (optional White, Black)
- Top connection of leg is reinforced with turn downs that will keep tops from warping

Options

- Premium Finish Option
- Specify leg Metal Finish color - \$160 per leg
  - MFB: Black, MFW: White
- Wire Management
- W17: Wire management cover - \$80
- Attaches to the leg by magnets

2 Select Finish

[Click to view finishes](#)

3 Select Edge

[Click to view edges](#)

4 Select Hardware

[Click to view details](#)

# Conference - Capitol Park

Full Pedestal Credenzas  
 Conferencing Storage Credenza

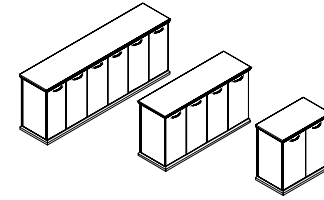

[Click here to view statement of line](#)

## 1 Select Model

w" x d" x h"	Weight
<b>Triple Storage</b>	
94 x 24 x 36	390
88 x 24 x 36	340
<b>Double Storage</b>	
71 x 24 x 36	290
65 x 24 x 36	260
59 x 24 x 36	245
48 x 24 x 36	200
<b>Single Storage</b>	
36 x 24 x 36	150
30 x 24 x 36	135

	Standard Veneer Top Standard Veneer Chassis		Premium Veneer Top Premium Veneer Chassis		High Pressure Laminate Top Veneer Chassis		Thermally Fused Laminate Top Thermally Fused Laminate Chassis	
<b>2 Select Finish</b> Click to view finishes								
<b>3 Select Edge</b> Click to view edges								
<b>4 Select Hardware</b> Click to view details								

## Product Features

- Adjustable glides
- Transitional - Hardwood base 2 1/2" H
- "W"/"G" styles have black adjustable shelf behind door set

## Notes

- Ganging: For end to end ganging, specify ganging flush cut modification for each ganged unit
- Unit has black back panel and is not designed for Open Plan use. Select OPB option for Open Plan application

## Options

- Accessories
- REF-01: Modify Storage section for refrigerator - \$205
- Audio Visual
- AVR1: AV Exhaust Fan - \$470
  - AVR2: AV Pullout Rack - \$2525
- Back Panel Wall Access
- M19: 2 Heat vent/cord access slots in back - \$ 160
- Door
- D2: Door Lock - \$100 per door set
  - D6A: "W"/"G" Styles - Delete Doors and replace black laminate shelf with finished shelf - n/c
- Flush Cut
- FC-B: Flush Unit Both Sides(Facing) for Ganging - \$100
  - FC-L: Flush Unit Left (Facing) for Ganging - \$100
  - FC-R: Flush Unit Right(Facing) for Ganging - \$100
- Open Plan \_ Finished Back
- OPB: W "G" Style - Modify Unit for Open Plan Application - \$195
- Trash Can
- TRC50: EZ Cargo 50 dual trash can - (1) 8 gallon and (1) 5 gallon - \$680

# Conference - Capitol Park

Full Pedestal Credenzas  
 Conferencing Buffet Credenza

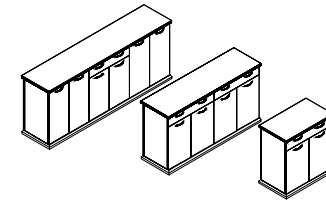

[Click here to view statement of line](#)

## 1 Select Model

w" x d" x h"  
 Triple Buffet  
 94 x 24 x 36  
 Double Buffet  
 71 x 24 x 36  
 Single Buffet  
 36 x 24 x 36

Weight	Standard Veneer Top Standard Veneer Chassis	Premium Veneer Top Premium Veneer Chassis	High Pressure Laminate Top Veneer Chassis	Thermally Fused Laminate Top Thermally Fused Laminate Chassis
390	CAP9424CA126W 8518	"P" Option N/A	CAP9424CA126G 8518	"M" Option N/A
300	CAP7124CA126W 7060	"P" Option N/A	CAP7124CA126G 7060	"M" Option N/A
175	CAP3624CA126W	"P" Option N/A	CAP3624CA126G 3874	"M" Option N/A

## Product Features

- Adjustable glides
- Transitional - Hardwood base 2 1/2" H
- Utility drawer w/ felt liner
- "W"/"G" styles have black adjustable shelf behind door set

## Notes

- Ganging: For end to end ganging, specify ganging flush cut modification for each ganged unit
- Unit has black back panel and is not designed for Open Plan use. Select OPB option for Open Plan application

## Options

- Door
- D2: Door Lock - \$100 per door set
  - D6A: "W"/"G" Styles - Delete Doors and replace black laminate shelf with finished shelf - n/c
- Flush Cut
- FC-B: Flush Unit Both Sides(Facing) for Ganging - \$100
  - FC-L: Flush Unit Left (Facing) for Ganging - \$100
  - FC-R: Flush Unit Right(Facing) for Ganging - \$100
- Open Plan \_ Finished Back
- OPB: "W"/"G" Style - Modify Unit for Open Plan Application - \$195
- Trash Can
- TRC50: EZ Cargo 50 dual trash can - (1) 8 gallon and (1) 5 gallon - \$650

## 2 Select Finish

[Click to view finishes](#)

## 3 Select Edge

[Click to view edges](#)



## 4 Select Hardware

[Click to view details](#)

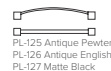
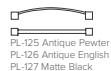

# Conference - Central Park

Full Pedestal Credenzas  
 Conferencing Storage Credenza

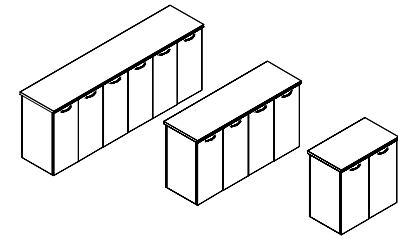

[Click here to view statement of line](#)

## 1 Select Model

w" x d" x h"	Weight
Triple Storage	
93 x 24 x 36	390
87 x 24 x 36	340
Double Storage	
70 x 24 x 36	290
64 x 24 x 36	260
58 x 24 x 36	245
47 x 24 x 36	200
Single Storage	
35 x 24 x 36	150
29 x 24 x 36	135

	Standard Veneer Top Standard Veneer Chassis		Premium Veneer Top Premium Veneer Chassis		High Pressure Laminate Top Veneer Chassis		Thermally Fused Laminate Top Thermally Fused Laminate Chassis	
	CPC9324CA124W	7427	CPC9324CA124P	8170	CPC9324CA124G	7427	CPC9324CA124M	3874
	CPC8724CA124W	7237	CPC8724CA124P	7962	CPC8724CA124G	7237	CPC8724CA124M	3588
	CPC7024CA124W	5125	CPC7024CA124P	5639	CPC7024CA124G	5125	CPC7024CA124M	2962
	CPC6424CA124W	4936	CPC6424CA124P	5431	CPC6424CA124G	4936	CPC6424CA124M	2904
	CPC5824CA124W	4650	CPC5824CA124P	5116	CPC5824CA124G	4650	CPC5824CA124M	2845
	CPC4724CA124W	4461	CPC4724CA124P	4907	CPC4724CA124G	4461	CPC4724CA124M	2729
	CPC3524CA124W	2826	CPC3524CA124P	3109	CPC3524CA124G	2826	CPC3524CA124M	1605
	CPC2924CA124W	2634	CPC2924CA124P	2898	CPC2924CA124G	2634	CPC2924CA124M	1554

## Product Features

- Adjustable glides
- "M" styles shelves match finish
- "W"/"G" styles have black adjustable shelf behind door set

## Notes

- All units are std with flush ends
- Unit has black back panel and is not designed for Open Plan use. Select OPB option for Open Plan application

## Options

- Accessories
  - REF-01: Modify Storage section for refrigerator - \$205
- Audio Visual
  - AVR1: AV Exhaust Fan - \$470
  - AVR2: AV Pullout Rack - \$2525
- Back Panel Wall Access
  - M19: 2 Heat vent/cord access slots in back - \$ 160
- Door
  - D2: Wood Door Lock - \$100 per door set
  - D6: Delete doors - n/c
  - D6A: "W"/"G" Styles - Delete Doors and replace black laminate shelf with finished shelf - n/c
- Open Plan \_ Finished Back
  - OPB: "W"/"G" Style - Modify Unit for Open Plan Application - \$195
  - OPB: "M" Style - Modify Unit for Open Plan Application - \$95
- Shelf
  - S25: Replace Black Laminate Shelf with Finished Shelf - \$80 per shelf
- Trash Can
  - TRC50: EZ Cargo 50 dual trash can - (1) 8 gallon and (1) 5 gallon - \$680

## 2 Select Finish

[Click to view finishes](#)

## 3 Select Edge

[Click to view edges](#)

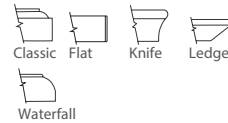
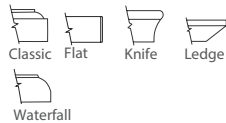

## 4 Select Hardware

[Click to view details](#)

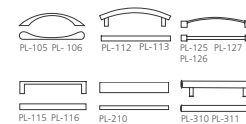
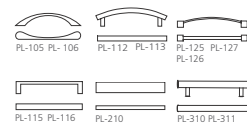
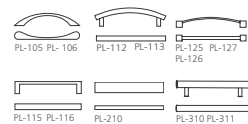
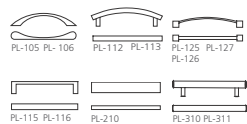

# Conference - Central Park

Full Pedestal Credenzas  
 Conferencing Buffet Credenza

[Click here to view statement of line](#)

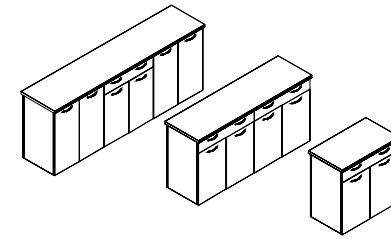

## 1 Select Model

w" x d" x h"  
 Triple Buffet  
 93 x 24 x 36  
 Double Buffet  
 70 x 24 x 36  
 Single Buffet  
 35 x 24 x 36

Weight	Standard Veneer Top Standard Veneer Chassis		Premium Veneer Top Premium Veneer Chassis		High Pressure Laminate Top Veneer Chassis		Thermally Fused Laminate Top Thermally Fused Laminate Chassis	
	Model	Weight	Model	Weight	Model	Weight	Model	Weight
390	CPC9324CA126W	8195	CPC9324CA126P	9015	CPC9324CA126G	8195	CPC9324CA126M	4344
300	CPC7024CA126W	6661	CPC7024CA126P	7328	CPC7024CA126G	6661	CPC7024CA126M	3435
175	CPC3524CA126W	3701	CPC3524CA126P	4073	CPC3524CA126G	3701	CPC3524CA126M	1845

## Product Features

- "M" styles have finished adjustable shelf behind door set
- Adjustable glides
- Full extension drawers - locking
- "W"/"G" styles have black adjustable shelf behind door set
- Utility drawer w/ felt liner

## Notes

- All units are std with flush ends
- Unit has black back panel and is not designed for Open Plan use. Select OPB option for Open Plan application

## Options

### Accessories

- REF-01: Modify Storage section for refrigerator - \$205
- Option is available on 93 x 24 x 36

### Door

- D2: Wood Door Lock - \$100 per door set
- D6: Delete doors - n/c
- D6A: "W"/"G" Styles - Delete Doors and replace black laminate shelf with finished shelf - n/c

### Open Plan \_ Finished Back

- OPB: "W"/"G" Style - Modify Unit for Open Plan Application - \$195
- OPB: "M" Style - Modify Unit for Open Plan Application - \$95

### Trash Can

- TRC50: EZ Cargo 50 dual trash can - (1) 8 gallon and (1) 5 gallon - \$680

## 2 Select Finish

[Click to view finishes](#)

## 3 Select Edge

[Click to view edges](#)

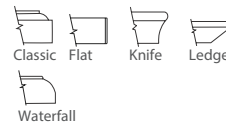
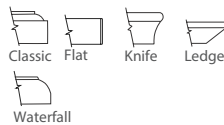

## 4 Select Hardware

[Click to view details](#)

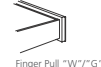
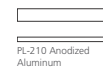
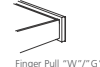
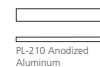
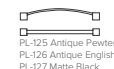
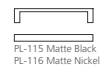
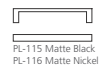
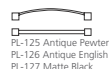
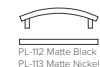

# Conference - Central Park

Conferencing Caseloads  
Mobile Extension Buffet Cart

[Click here to view statement of line](#)

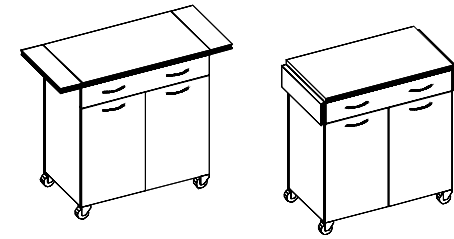

## 1 Select Model

w" x d" x h"  
35 x 24 x 36

Weight  
170

Standard Veneer Top Standard Veneer Chassis		Premium Veneer Top Premium Veneer Chassis		High Pressure Laminate Top Veneer Chassis	Thermally Fused Laminate Top Thermally Fused Laminate Chassis	
CPC3524SC483W	3401	CPC3524SC483P	3741	"G" Option N/A	CPC3524SC483M	2105

## Product Features

- (2) TM50 grommets in backpanel
- Flat/Flush ends
- Hinged top extensions
- Full extension drawers - locking silver casters
- Open storage & closed cabinet w/ grommet

## 2 Select Finish

[Click to view finishes](#)

## 3 Select Edge

[Click to view edges](#)

Edge  
N/A

Edge  
N/A

Edge  
N/A

## 4 Select Hardware

[Click to view details](#)

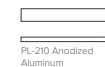
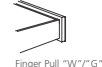
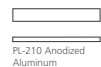
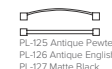
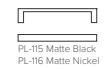
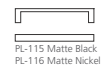
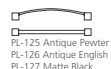
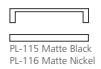

# Conference - Central Park

Visual Boards

Visual Board

[Click here to view statement of line](#)

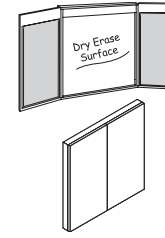

**1 Select Model**

w" x d" x h"	Weight
48 x 4 x 48	130
36 x 4 x 48	120
48 x 4 x 36	120
36 x 4 x 36	110

	Standard Veneer Top Standard Veneer Chassis		Premium Veneer Top Premium Veneer Chassis		High Pressure Laminate Top Veneer Chassis	Thermally Fused Laminate Top Thermally Fused Laminate Chassis
	CPC4848VB475W	3826	CPC4848VB475P	4210	"G" Option N/A	CPC4848VB475M 1649
	CPC3648VB475W	3552	CPC3648VB475P	3908	"G" Option N/A	CPC3648VB475M 1591
	CPC4836VB475W	3552	CPC4836VB475P	3908	"G" Option N/A	CPC4836VB475M 1591
	CPC3636VB475W	3086	CPC3636VB475P	3396	"G" Option N/A	CPC3636VB475M 1534

**Product Features**

- Built-in wall levelers
- Doors are 1" thick
- Fabric tack surface on doors (spinel sandstone)
- Finger pull at bottom
- White dry marker surface

**Options**

Accessories

- DMKIT: Dry marker kit for visual board - \$50
- Includes: 4 colored markers, eraser, 4 magnetic pins
- DMRT01: Replace fabric panels with dry marker/erase board - \$100

**2 Select Finish**

[Click to view finishes](#)

**3 Select Edge**

[Click to view edges](#)

Edge  
N/A

Edge  
N/A

Edge  
N/A

**4 Select Hardware**

[Click to view details](#)

Hardware  
N/A

Hardware  
N/A

Hardware  
N/A

## Conference - Central Park

Lecterns

Lectern

[Click here to view statement of line](#)

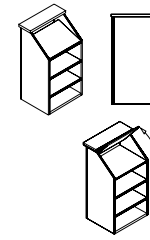

### 1 Select Model

w" x d" x h"  
24 x 24 x 46

Weight  
130

Standard Veneer Top Standard Veneer Chassis		Premium Veneer Top Premium Veneer Chassis		High Pressure Laminate Top Veneer Chassis	Thermally Fused Laminate Top Thermally Fused Laminate Chassis	
CPC2424LC499W	3581	CPC2424LC499P	3938	"G" Option N/A	CPC2424LC499M	1586

### Product Features

- 2 Adjustable shelves
- Front wheels/casters for easy relocation
- Lectern surface tilts up for storage

### 2 Select Finish

[Click to view finishes](#)

### 3 Select Edge

[Click to view edges](#)

Edge  
N/A

Edge  
N/A

Edge  
N/A

Edge  
N/A

### 4 Select Hardware

[Click to view details](#)

Hardware  
N/A

Hardware  
N/A

Hardware  
N/A

Hardware  
N/A



# Conference - Jamestown

Full Pedestal Credenzas  
 Conferencing Storage Credenza

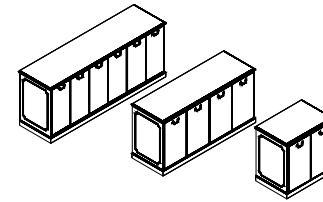

[Click here to view statement of line](#)

## 1 Select Model

w" x d" x h"	Weight
Triple Storage	
95 x 24 x 36	390
89 x 24 x 36	340
Double Storage	
72 x 24 x 36	260
66 x 24 x 36	260
60 x 24 x 36	245
48 x 24 x 36	200
Single Storage	
37 x 24 x 36	130
31 x 24 x 36	135

	Standard Veneer Top Standard Veneer Chassis		Premium Veneer Top Premium Veneer Chassis		High Pressure Laminate Top Veneer Chassis		Thermally Fused Laminate Top Thermally Fused Laminate Chassis	
	JCM9524CA124W	8833	"P" Option N/A	JCM9524CA124G	8833	"M" Option N/A	JCM9524CA124G	8833
	JCM8924CA124W	8055	"P" Option N/A	JCM8924CA124G	8055	"M" Option N/A	JCM8924CA124G	8055
	JCM7224CA124W	6634	"P" Option N/A	JCM7224CA124G	6634	"M" Option N/A	JCM7224CA124G	6634
	JCM6624CA124W	6494	"P" Option N/A	JCM6624CA124G	6494	"M" Option N/A	JCM6624CA124G	6494
	JCM6024CA124W	6423	"P" Option N/A	JCM6024CA124G	6423	"M" Option N/A	JCM6024CA124G	6423
	JCM4824CA124W	5784	"P" Option N/A	JCM4824CA124G	5784	"M" Option N/A	JCM4824CA124G	5784
	JCM3724CA124W	3387	"P" Option N/A	JCM3724CA124G	3387	"M" Option N/A	JCM3724CA124G	3387
	JCM3124CA124W	3168	"P" Option N/A	JCM3124CA124G	3168	"M" Option N/A	JCM3124CA124G	3168

## Product Features

- Finished adjustable shelf behind door set

## Notes

- Unit has black back panel and is not designed for Open Plan use. Select OPB option for Open Plan application

## Options

### Accessories

- REF-01: Modify Storage section for refrigerator - \$205

### Audio Visual

- AVR1: AV Exhaust Fan - \$470

- AVR2: AV Pullout Rack - \$2525

### Back Panel Wall Access

- M19: 2 Heat vent/cord access slots in back - \$ 160

### Molding Panel

- DSM2: Delete panel molding - Deduct \$50

### Door

- D2: Wood Door Lock - \$100 per door set

- D6: Delete doors - n/c

### Flush Cut

- FC-B: Flush Unit Both Sides(Facing) for Ganging - \$100

- FC-L: Flush Unit Left (Facing) for Ganging - \$100

- FC-R: Flush Unit Right(Facing) for Ganging - \$100

### Open Plan \_ Finished Back

- OPB: "W" "G" Style - Modify Unit for Open Plan Application - \$295

### Trash Can

- TRC50: EZ Cargo 50 dual trash can - (1) 8 gallon and (1) 5 gallon - \$680

## 2 Select Finish

[Click to view finishes](#)

- WEC
- WAC
- WIC
- WHC
- WOC
- WGW
- WBW
- WSW
- WNW
- WEW
- WWW

- GEC
- GAC
- GIC
- GHC
- GOC
- GNW
- GEW

## 3 Select Edge

[Click to view edges](#)



## 4 Select Hardware

[Click to view details](#)



# Conference - Jamestown

Full Pedestal Credenzas  
 Conferencing Buffet Credenza

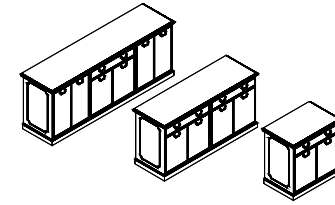

[Click here to view statement of line](#)

## 1 Select Model

w" x d" x h"  
 Triple Buffet  
 95 x 24 x 36  
 Double Buffet  
 72 x 24 x 36  
 Single Buffet  
 37 x 24 x 36

Weight	Standard Veneer Top Standard Veneer Chassis		Premium Veneer Top Premium Veneer Chassis		High Pressure Laminate Top Veneer Chassis		Thermally Fused Laminate Top Thermally Fused Laminate Chassis	
	400	JCM9524CA126W	9930	"P" Option N/A	JCM9524CA126G	9930	"M" Option N/A	
300	JCM7224CA126W	7363	"P" Option N/A	JCM7224CA126G	7363	"M" Option N/A		
150	JCM3724CA126W	3843	"P" Option N/A	JCM3724CA126G	3843	"M" Option N/A		

## Product Features

- Finished adjustable shelf behind door set
- Utility drawer w/ felt liner

## Notes

- Unit has black back panel and is not designed for Open Plan use. Select OPB option for Open Plan application

## Options

### Accessories

- REF-01: Modify Storage section for refrigerator - \$205  
 Option is available on 95"

### Molding

- DSM2: Delete panel molding - Deduct \$50

### Door

- D6: Delete doors - n/c

### Flush Cut

- FC-B: Flush Unit Both Sides(Facing) for Ganging - \$100
- FC-L: Flush Unit Left (Facing) for Ganging - \$100
- FC-R: Flush Unit Right(Facing) for Ganging - \$100

### Open Plan \_ Finished Back

- OPB: "W" "G" Style - Modify Unit for Open Plan Application - \$295

### Trash Can

- TRC50: EZ Cargo 50 dual trash can - (1) 8 gallon and (1) 5 gallon - \$650

## 2 Select Finish

[Click to view finishes](#)

## 3 Select Edge

[Click to view edges](#)



## 4 Select Hardware

[Click to view details](#)



# Conference - Jamestown

Cabinets

Traditional Telephone Cabinet

[Click here to view statement of line](#)

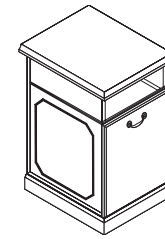

**1 Select Model**

w" x d" x h"

16 x 22 x 29

Weight

50

Standard Veneer Top Standard Veneer Chassis		Premium Veneer Top Premium Veneer Chassis		High Pressure Laminate Top Veneer Chassis		Thermally Fused Laminate Top Thermally Fused Laminate Chassis	
--	--	--	--	--	--	--	--

JCM1622TS487W	2502	"P" Option N/A		JCM1622TS487G	2502	"M" Option N/A	
---------------	------	----------------	--	---------------	------	----------------	--

**Product Features**

- Hardwood base and moldings

**Options**

Flush Cut

- FC-B: Flush Unit Both Sides(Facing) for Ganging - \$100
- FC-L: Flush Unit Left (Facing) for Ganging - \$100
- FC-R: Flush Unit Right(Facing) for Ganging - \$100

Molding

- STC01: Optional Scalloped Molding - \$105
- DSM2: Delete panel molding - Deduct \$50

Open Plan \_ Finished Back

- OPB: "W" "G" Style - Modify Unit for Open Plan Application - \$295

**2 Select Finish**

[Click to view finishes](#)

**3 Select Edge**

[Click to view edges](#)



**4 Select Hardware**

[Click to view details](#)



# Conference - NOT SO square

Full Pedestal Credenzas  
 Conferencing Storage Credenza

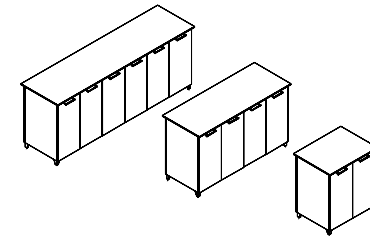

[Click here to view statement of line](#)

## 1 Select Model

w" x d" x h"  
 Triple Storage  
 95 x 24 x 36  
 89 x 24 x 36  
 Double Storage  
 72 x 24 x 36  
 66 x 24 x 36  
 60 x 24 x 36  
 48 x 24 x 36  
 3130  
 Single Storage  
 37 x 24 x 36  
 31 x 24 x 36

Weight	Standard Veneer Top Standard Veneer Chassis		Premium Veneer Top Premium Veneer Chassis		High Pressure Laminate Top Veneer Chassis		Thermally Fused Laminate Top Thermally Fused Laminate Chassis	
400	NSS9524CA124W	5653	NSS9524CA124P	6219	NSS9524CA124G	5653	NSS9524CA124M	4429
360	NSS8924CA124W	5528	NSS8924CA124P	6081	NSS8924CA124G	5528	NSS8924CA124M	4117
300	NSS7224CA124W	4799	NSS7224CA124P	5280	NSS7224CA124G	4799	NSS7224CA124M	3386
275	NSS6624CA124W	4670	NSS6624CA124P	5137	NSS6624CA124G	4670	NSS6624CA124M	3324
250	NSS6024CA124W	4540	NSS6024CA124P	4994	NSS6024CA124G	4540	NSS6024CA124M	3259
200	NSS4824CA124W	4281	NSS4824CA124P	4709	NSS4824CA124G	4281	NSS4824CA124M	
150	NSS3724CA124W	2578	NSS3724CA124P	2837	NSS3724CA124G	2578	NSS3724CA124M	1848
135	NSS3124CA124W	2393	NSS3124CA124P	2634	NSS3124CA124G	2393	NSS3124CA124M	1792

## 2 Select Finish

[Click to view finishes](#)  
  
 Metal Finish  
 MFS Silver. Additional  
 Metal Finishes are  
 available, options

## 3 Select Edge

[Click to view edges](#)



## 4 Select Hardware

[Click to view details](#)

## Product Features

- Adjustable glides
- "M" styles shelves match finish
- Standard Silver feet (optional White, Black)
- Storage cabinet w/ adjustable black laminate shelf

## Notes

- Ganging: For end to end ganging, specify ganging flush cut modification for each ganged unit

## Options

- Accessories
- REF-01: Modify Storage section for refrigerator - \$205
- Audio Visual
- AVR1: AV Exhaust Fan - \$470
  - AVR2: AV Pullout Rack - \$2525
- Door
- D2: Wood Door Lock - \$100 per door set
  - D6: Delete Doors - n/c
  - D6A: "W"/"G" Styles - Delete Doors and replace black laminate shelf with finished shelf - n/c
  - D8: Delete feet (includes extended fronts to the floor) - n/c
- Flush Cut
- FC-B: Flush Unit Both Sides(Facing) for Ganging - \$55
  - FC-L: Flush Unit Left (Facing) for Ganging - \$55
  - FC-R: Flush Unit Right(Facing) for Ganging - \$55
- Open Plan \_ Finished Back
- OPB: "W"/"G" Style - Modify Unit for Open Plan Application - \$195
  - OPBM: "M" Style - Modify Unit for Open Plan Application - \$95
- Premium Finish Option
- Specify foot Metal Finish color - \$30 per foot
  - MFB: Black, MFW: White
- Shelf
- S25: Replace Black Laminate Shelf with Finished Shelf - \$80 per shelf
- Trash Can
- TRC230: Trash Can Insert - (2) 30 gal containers - \$495

# Conference - NOT SO square

Storage Credenzas  
Buffet / Storage Credenzas

[Click here to view statement of line](#)

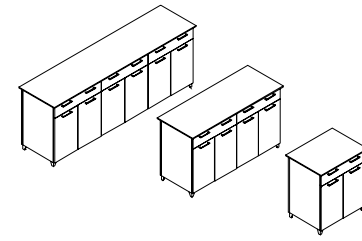

## 1 Select Model

w" x d" x h"	Weight
Triple Storage	
95 x 24 x 36	400
89 x 24 x 36	360
Double Storage	
72 x 24 x 36	300
60 x 24 x 36	250
Single Storage	
37 x 24 x 36	150
2112	
31 x 24 x 36	135

	Standard Veneer Top Standard Veneer Chassis		Premium Veneer Top Premium Veneer Chassis		High Pressure Laminate Top Veneer Chassis		Thermally Fused Laminate Top Thermally Fused Laminate Chassis	
	NSS9524CA126W	6150	NSS9524CA126P	6765	NSS9524CA126G	6150	NSS9524CA126M	4956
	NSS8924CA126W	5956	NSS8924CA126P	6553	NSS8924CA126G	5956	NSS8924CA126M	4644
	NSS7224CA126W	5085	NSS7224CA126P	5594	NSS7224CA126G	5085	NSS7224CA126M	3911
	NSS6024CA126W	4828	NSS6024CA126P	5310	NSS6024CA126G	4828	NSS6024CA126M	3785
	NSS3724CA126W	2723	NSS3724CA126P	2995	NSS3724CA126G	2723	NSS3724CA126M	
	NSS3124CA126W	2537	NSS3124CA126P	2790	NSS3124CA126G	2537	NSS3124CA126M	2053

## 2 Select Finish

[Click to view finishes](#)

## 3 Select Edge

[Click to view edges](#)



NSS Bevel



NSS Bevel



NSS Bevel



NSS Bevel

## 4 Select Hardware

[Click to view details](#)



PL-115 Matte Black  
PL-116 Matte Nickel



PL-210 Anodized  
Aluminum



PL-115 Matte Black  
PL-116 Matte Nickel



PL-210 Anodized  
Aluminum



PL-115 Matte Black  
PL-116 Matte Nickel



PL-210 Anodized  
Aluminum



PL-115 Matte Black  
PL-116 Matte Nickel



PL-210 Anodized  
Aluminum

## Product Features

- 1 adjustable black laminate shelf behind each door set
- Soft close suspension drawer(s)
- Standard Silver Feet (optional White, Black)

## Notes

- Unit not designed for open plan use. Select OPB for Open Plan application

## Options

### Door

- D2: Door Lock - \$100 per door set
- D6: Delete Doors - n/c
- D6A: "W"/"G" Styles - Delete Doors and replace black laminate shelf with finished shelf - n/c
- D9SC: Soft Close Door Hinges - \$20 per door

### Feet

- D8: Delete feet (includes extended fronts to the floor) - n/c

### Flush Cut

- FC-B: Flush Unit Both Sides(Facing) for Ganging - \$55
- FC-L: Flush Unit Left (Facing) for Ganging - \$55
- FC-R: Flush Unit Right(Facing) for Ganging - \$55

### Grommets (Standard Location)

Specify Color and Location (Right/Left/Center) - \$50 ea.

- Black: TM30-R (Right), TM30-L (Left), TM30-C (Center)
- Silver: TM31-R (Right), TM31-L (Left), TM31-C (Center)
- White: TM34-R (Right), TM34-L (Left), TM34-C (Center)

### Grommets (Non-Standard Location)

Provide drawing w/ Grommet Location and Specify Color - \$95 ea.

- Black: TM30-NS
- Silver: TM31-NS
- White: TM34-NS

### Grommet (Vertical Surface)

Standard Location - \$50 ea.

- Black Plastic Vertical Surface: TM50-C (Bottom Center)

Non-Standard Location - \$90 ea.

- Black Plastic Vertical Surface: TM50-NS

### Open Plan \_ Finished Back

- OPB: "W"/"G" Style - Modify Unit for Open Plan Application - \$195
- OPBM: "M" Style - Modify Unit for Open Plan Application - \$95

### Premium Finish Option

- Specify foot Metal Finish color - \$30 per foot
- MFB: Black, MFW: White

### Trash Can

- TRC230: Trash Can Insert - (2) 30 gal containers - \$495

# Conference - NOT SO square

Storage Credenzas  
Console Cabinets

[Click here to view statement of line](#)

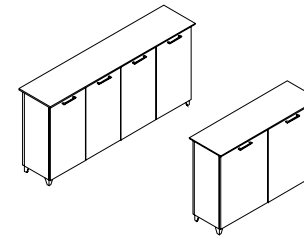

## 1 Select Model

w" x d" x h"

Weight	4 Door	2 Door
210	72 x 15 x 36	48 x 15 x 36
175	60 x 15 x 36	36 x 15 x 36
140		48 x 15 x 36
110		36 x 15 x 36

	Standard Veneer Top Standard Veneer Chassis		Premium Veneer Top Premium Veneer Chassis		High Pressure Laminate Top Veneer Chassis		Thermally Fused Laminate Top Thermally Fused Laminate Chassis	
4 Door	NSS7215CA524W	4218	NSS7215CA524P	4642	NSS7215CA524G	4218	NSS7215CA524M	2719
60 x 15 x 36	NSS6015CA524W	4117	NSS6015CA524P	4530	NSS6015CA524G	4117	NSS6015CA524M	2477
2 Door	NSS4815CA524W	2537	NSS4815CA524P	2790	NSS4815CA524G	2537	NSS4815CA524M	1778
36 x 15 x 36	NSS3615CA524W	2200	NSS3615CA524P	2420	NSS3615CA524G	2200	NSS3615CA524M	1578

## Product Features

- 1 adjustable black laminate shelf behind each section
- Interior shelf depth 12"
- Standard Silver Feet (optional White, Black)

## Notes

- Unit not designed for open plan use. Select OPB for Open Plan application

## Options

### Door

- D2: Door Lock - \$100 per door set
- D6: Delete Doors - n/c
- D6A: "W"/"G" Styles - Delete Doors and replace black laminate shelf with finished shelf - n/c
- D9SC: Soft Close Door Hinges - \$20 per door

### Feet

- D8: Delete feet (includes extended fronts to the floor) - n/c

### Flush Cut

- FC-B: Flush Unit Both Sides(Facing) for Ganging - \$55
- FC-L: Flush Unit Left (Facing) for Ganging - \$55
- FC-R: Flush Unit Right(Facing) for Ganging - \$55

### Grommets (Standard Location)

Specify Color and Location (Right/Left/Center) - \$50 ea.

- Black: TM30-R (Right), TM30-L (Left), TM30-C (Center)
- Silver: TM31-R (Right), TM31-L (Left), TM31-C (Center)
- White: TM34-R (Right), TM34-L (Left), TM34-C (Center)
- TM50: Black grommet in back panel - \$45

### Grommets (Non-Standard Location)

Provide drawing w/ Grommet Location and Specify Color - \$95 ea.

- Black: TM30-NS

- Silver: TM31-NS

- White: TM34-NS

### Grommet (Vertical Surface)

Standard Location - \$50 ea.

- Black Plastic Vertical Surface: TM50-C (Bottom Center)

Non-Standard Location - \$90 ea.

- Black Plastic Vertical Surface: TM50-NS

### Open Plan \_ Finished Back

- OPB: "W"/"G" Style - Modify Unit for Open Plan Application - \$195

- OPBM: "M" Style - Modify Unit for Open Plan Application - \$95

### Shelves

- S25: "W"/"G" Styles - Replace Black Laminate Shelf with Finished Shelf - \$80 per shelf
- S714F: Heavy Duty Lumber 1" Shelves - \$80 per shelf ("M" Styles - n/a)

### Premium Finish Option

- Specify foot Metal Finish color - \$30 per foot
- MFB: Black, MFW: White

## 2 Select Finish

[Click to view finishes](#)

## 3 Select Edge

[Click to view edges](#)



## 4 Select Hardware

[Click to view details](#)

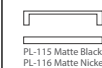
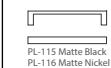

# Conference - Prado

Full Pedestal Credenzas  
 Conferencing Storage Credenza

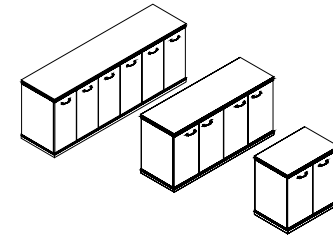

[Click here to view statement of line](#)

### 1 Select Model

w" x d" x h"

	Weight	Standard Veneer Top Standard Veneer Chassis		Premium Veneer Top Premium Veneer Chassis		High Pressure Laminate Top Veneer Chassis		Thermally Fused Laminate Top Thermally Fused Laminate Chassis	
<b>Triple Storage</b>									
94 x 24 x 36	360	PRA9424CA124W	9155	"P" Option N/A		PRA9424CA124G	9155	"M" Option N/A	
88 x 24 x 36	345	PRA8824CA124W	8980	"P" Option N/A		PRA8824CA124G	8980	"M" Option N/A	
<b>Double Storage</b>									
71 x 24 x 36	270	PRA7124CA124W	6913	"P" Option N/A		PRA7124CA124G	6913	"M" Option N/A	
65 x 24 x 36	260	PRA6524CA124W	6779	"P" Option N/A		PRA6524CA124G	6779	"M" Option N/A	
59 x 24 x 36	220	PRA5924CA124W	6649	"P" Option N/A		PRA5924CA124G	6649	"M" Option N/A	
48 x 24 x 36	210	PRA4824CA124W	6381	"P" Option N/A		PRA4824CA124G	6381	"M" Option N/A	
<b>Single Storage</b>									
36 x 24 x 36	160	PRA3624CA124W	3954	"P" Option N/A		PRA3624CA124G	3954	"M" Option N/A	
30 x 24 x 36	150	PRA3024CA124W	3781	"P" Option N/A		PRA3024CA124G	3781	"M" Option N/A	

### 2 Select Finish

[Click to view finishes](#)

### 3 Select Edge

[Click to view edges](#)



### 4 Select Hardware

[Click to view details](#)

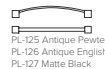
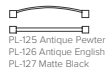

### Product Features

- Adjustable glides
- 1 Adjustable black shelf/storage
- Hardwood base / dentil molding

### Options

#### Accessories

- REF-01: Modify Storage section for refrigerator - \$205

#### Audio Visual

- AVR1: AV Exhaust Fan - \$470
- AVR2: AV Pullout Rack - \$2525

#### Back Panel Wall Access

- M19: 2 Heat vent/cord access slots in back - \$ 160

#### Door

- D2: Wood Door Lock - \$100 per door set

#### Flush Cut

- FC-B: Flush Unit Both Sides(Facing) for Ganging - \$100
- FC-L: Flush Unit Left (Facing) for Ganging - \$100
- FC-R: Flush Unit Right(Facing) for Ganging - \$100

#### Open Plan \_ Finished Back

- OPB: "W" "G" Style - Modify Unit for Open Plan Application - \$195

#### Trash Can

- TRC50: EZ Cargo 50 dual trash can - (1) 8 gallon and (1) 5 gallon - \$680

#### Shelf

- S25: Replace Black Laminate Shelf with Finished Shelf - \$80 per shelf

# Conference - Prado

Full Pedestal Credenzas  
 Conferencing Buffet Credenza

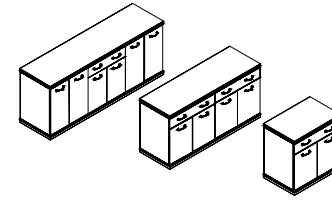

[Click here to view statement of line](#)

## 1 Select Model

w" x d" x h"  
 Triple Buffet  
 94 x 24 x 36  
 Double Buffet  
 71 x 24 x 36  
 Single Buffet  
 36 x 24 x 36

Weight	Standard Veneer Top Standard Veneer Chassis	Premium Veneer Top Premium Veneer Chassis	High Pressure Laminate Top Veneer Chassis	Thermally Fused Laminate Top Thermally Fused Laminate Chassis
350	PRA9424CA126W 8839	"P" Option N/A	PRA9424CA126G 8839	"M" Option N/A
300	PRA7124CA126W 7765	"P" Option N/A	PRA7124CA126G 7765	"M" Option N/A
160	PRA3624CA126W 4130	"P" Option N/A	PRA3624CA126G 4130	"M" Option N/A

## 2 Select Finish

[Click to view finishes](#)

WEC  
 WAC  
 WIC  
 WHC  
 WOC  
 WEW  
 GWG  
 WBW  
 WSW  
 WNW  
 WWW

GEC  
 GAC  
 GIC  
 GHC  
 GOC  
 GNW  
 GEW

## 3 Select Edge

[Click to view edges](#)



## 4 Select Hardware

[Click to view details](#)

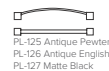
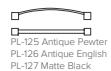

## Product Features

- 1 Adjustable black shelf/storage
- Utility drawer w/ felt liner

## Options

### Accessories

- REF-01: Modify Storage section for refrigerator - \$205

### Door

- D2: Wood Door Lock - \$100 per door set

### Flush Cut

- FC-B: Flush Unit Both Sides(Facing) for Ganging - \$100
- FC-L: Flush Unit Left (Facing) for Ganging - \$100
- FC-R: Flush Unit Right(Facing) for Ganging - \$100

### Open Plan \_ Finished Back

- OPB: "W" "G" Style - Modify Unit for Open Plan Application - \$195

### Trash Can

- TRCS0: EZ Cargo 50 dual trash can - (1) 8 gallon and (1) 5 gallon - \$650

### Shelf

- S25: Replace Black Laminate Shelf with Finished Shelf - \$80 per shelf



# Conference - Richmond Park

Full Pedestal Credenzas  
 Conferencing Storage Credenza

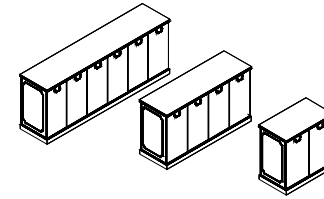

[Click here to view statement of line](#)

## 1 Select Model

w" x d" x h"  
 Triple Storage  
 95 x 24 x 36  
 89 x 24 x 36  
 Double Storage  
 72 x 24 x 36  
 66 x 24 x 36  
 60 x 24 x 36  
 48 x 24 x 36  
 Single Storage  
 37 x 24 x 36  
 31 x 24 x 36

Weight	Standard Veneer Top Standard Veneer Chassis		Premium Veneer Top Premium Veneer Chassis		High Pressure Laminate Top Veneer Chassis		Thermally Fused Laminate Top Thermally Fused Laminate Chassis	
390	RPC9524CA124W	8336	"P" Option N/A	RPC9524CA124G	8336	"M" Option N/A		
340	RPC8924CA124W	8141	"P" Option N/A	RPC8924CA124G	8141	"M" Option N/A		
290	RPC7224CA124W	5855	"P" Option N/A	RPC7224CA124G	5855	"M" Option N/A		
260	RPC6624CA124W	5664	"P" Option N/A	RPC6624CA124G	5664	"M" Option N/A		
245	RPC6024CA124W	5474	"P" Option N/A	RPC6024CA124G	5474	"M" Option N/A		
200	RPC4824CA124W	5092	"P" Option N/A	RPC4824CA124G	5092	"M" Option N/A		
150	RPC3724CA124W	3380	"P" Option N/A	RPC3724CA124G	3380	"M" Option N/A		
135	RPC3124CA124W	3190	"P" Option N/A	RPC3124CA124G	3190	"M" Option N/A		

## 2 Select Finish

[Click to view finishes](#)

## 3 Select Edge

[Click to view edges](#)



Richmond Classic



Richmond Classic

## 4 Select Hardware

[Click to view details](#)



PL-4 Antique Brass



PL-5 Antique Brass  
 PL-50 Brushed Pewter



PL-4 Antique Brass



PL-5 Antique Brass  
 PL-50 Brushed Pewter

## Product Features

- Adjustable black laminate shelf per section
- Adjustable glides
- Traditional - Molding, hardwood base & profile edge on drawers / doors

## Notes

- Ganging: For end to end ganging, specify ganging flush cut modification for each ganged unit

## Options

- Accessories
- REF-01: Modify Storage section for refrigerator - \$205
- Audio Visual
- AVR1: AV Exhaust Fan - \$470
  - AVR2: AV Pullout Rack - \$2525
- Back Panel Wall Access
- M19: 2 Heat vent/cord access slots in back - \$ 160
- Molding Panel
- DSM2: Delete panel molding - Deduct \$50
- Door
- D2: Wood Door Lock - \$100 per door set
  - D6: Delete Doors - n/c
  - D6A: "W"/"G" Styles - Delete Doors and replace black laminate shelf with finished shelf - n/c
- Flush Cut
- FC-B: Flush Unit Both Sides(Facing) for Ganging - \$100
  - FC-L: Flush Unit Left (Facing) for Ganging - \$100
  - FC-R: Flush Unit Right(Facing) for Ganging - \$100
- Open Plan \_ Finished Back
- OPB: "W" Style - Modify Unit for Open Plan Application - \$295
- Trash Can
- TRC50: EZ Cargo 50 dual trash can - (1) 8 gallon and (1) 5 gallon - \$680

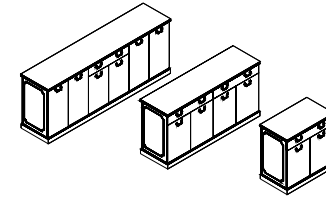

[Click here to view statement of line](#)

1 Select Model

w" x d" x h"  
Triple Buffet  
95 x 24 x 36  
Double Buffet  
72 x 24 x 36  
Single Buffet  
37 x 24 x 36

Weight	Standard Veneer Top Standard Veneer Chassis		Premium Veneer Top Premium Veneer Chassis		High Pressure Laminate Top Veneer Chassis		Thermally Fused Laminate Top Thermally Fused Laminate Chassis	
390	RPC9524CA126W	9097	"P" Option N/A		RPC9524CA126G	9097	"M" Option N/A	
300	RPC7224CA126W	7572	"P" Option N/A		RPC7224CA126G	7572	"M" Option N/A	
175	RPC3724CA126W	4241	"P" Option N/A		RPC3724CA126G	4241	"M" Option N/A	

Product Features

- Adjustable glides
- Full extension drawers - locking
- Storage cabinet w/ adjustable black laminate shelf
- Traditional - Molding, hardwood base & profile edge on drawers / doors
- Utility drawer w/ felt liner

Notes

- Ganging: For end to end ganging, specify ganging flush cut modification for each ganged unit

Options

- Accessories
- REF-01: Modify Storage section for refrigerator - \$205
- Audio Visual
- AVR1: AV Exhaust Fan - \$470
  - AVR2: AV Pullout Rack - \$2525
- Back Panel Wall Access
- M19: 2 Heat vent/cord access slots in back - \$ 160
- Molding Panel
- DSM2: Delete panel molding - Deduct \$50
- Door
- D6: Delete Doors - n/c
  - D6A: "W"/"G" Styles - Delete Doors and replace black laminate shelf with finished shelf - n/c
- Open Plan \_ Finished Back
- OPB: "W"/"G" Style - Modify Unit for Open Plan Application - \$295
- Trash Can
- TRC50: EZ Cargo 50 dual trash can - (1) 8 gallon and (1) 5 gallon - \$650

2 Select Finish

[Click to view finishes](#)

3 Select Edge

[Click to view edges](#)



4 Select Hardware

[Click to view details](#)

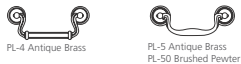

# Conference - Rift

## Conference Table

### Round Conference Table With Column

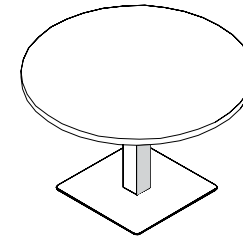

[Click here to view statement of line](#)

#### 1 Select Model

w" x d" x h"	Weight
48 DIA x 29.5	160
42 DIA x 29.5	150
36 DIA x 29.5	140
30 DIA x 29.5	135

Standard Veneer Top Standard Veneer Chassis	Premium Veneer Top Premium Veneer Chassis	High Pressure Laminate Top Veneer Chassis	Thermally Fused Laminate Top Thermally Fused Laminate Chassis
"W" Option N/A	RFT4848DT089P 3547	"G" Option N/A	"M" Option N/A
"W" Option N/A	RFT4242DT089P 3413	"G" Option N/A	"M" Option N/A
"W" Option N/A	RFT3636DT089P 3306	"G" Option N/A	"M" Option N/A
"W" Option N/A	RFT3030DT089P 3165	"G" Option N/A	"M" Option N/A

#### Product Features

- 1 - 1/2" Thick work surface
- 4" x 4" Steel column with accent wood panel insert centered under top
- Flat edge standard
- Steel platform with self-leveling cushion bottom

#### Seating Accommodations

- 48" and 42" diameter seats four to five
- 36" diameter seats three to four
- 30" diameter seats three

#### 2 Select Finish

[Click to view finishes](#)

#### 3 Select Edge

[Click to view edges](#)



#### 4 Select Hardware

[Click to view details](#)

Hardware  
N/A

# Conference - Rift

Top  
Rectangle

[Click here to view statement of line](#)

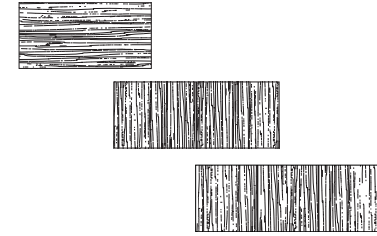

## 1 Select Model

3 Piece Top	Weight
40" x 60" x 6" h"	545
240 x 54	530
216 x 60	475
216 x 54	455
<b>2 Piece Top</b>	
192 x 54	405
168 x 54	355
144 x 48	270
120 x 48	225

Standard Veneer Top Standard Veneer Chassis	Premium Veneer Top Premium Veneer Chassis	High Pressure Laminate Top Veneer Chassis	Thermally Fused Laminate Top Thermally Fused Laminate Chassis
"W" Option N/A	RFT24060RE500P 13419	"G" Option N/A	"M" Option N/A
"W" Option N/A	RFT24054RE500P 12081	"G" Option N/A	"M" Option N/A
"W" Option N/A	RFT21660RE500P 12081	"G" Option N/A	"M" Option N/A
"W" Option N/A	RFT21654RE500P 10876	"G" Option N/A	"M" Option N/A
"W" Option N/A	RFT19254RE500P 8274	"G" Option N/A	"M" Option N/A
"W" Option N/A	RFT16854RE500P 8053	"G" Option N/A	"M" Option N/A
"W" Option N/A	RFT14448RE500P 7358	"G" Option N/A	"M" Option N/A
"W" Option N/A	RFT12048RE500P 6943	"G" Option N/A	"M" Option N/A



Hardware  
N/A

## Product Features

- 1.5" thick tops
- Tops and bases are pre-located to ensure proper installation location

### Seating Accommodations

- 240" seats sixteen to eighteen
- 216" seats twelve to fourteen
- 192" seats ten to twelve
- 168" seats ten
- 144" and 120" seats eight to ten
- 96" and 84" seats eight
- 72" seats six to eight

## Options

- Power / data communications support module hardware available in options selection
- Undertop wire trough and channels available in options section

## 2 Select Finish

[Click to view finishes](#)

## 3 Select Edge

[Click to view edges](#)

## 4 Select Hardware

[Click to view details](#)

# Conference - Rift

Top  
Boat

[Click here to view statement of line](#)

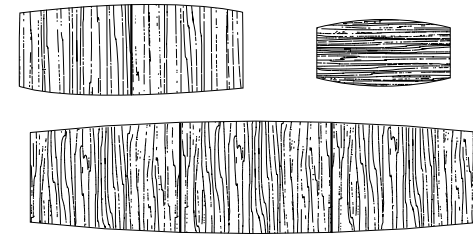

## 1 Select Model

w" x d" x h"	Weight
3 Piece Top	
240 x 60/48	545
240 x 54/42	530
216 x 60/48	475
216 x 54/42	455
2 Piece Top	
192 x 54/42	385
168 x 54/42	335
144 x 48/39	250
120 x 48/39	215
1 Piece Top	
96 x 48/36	170
84 x 42/32	130
72 x 36/30	100

	Standard Veneer Top Standard Veneer Chassis	Premium Veneer Top Premium Veneer Chassis	High Pressure Laminate Top Veneer Chassis	Thermally Fused Laminate Top Thermally Fused Laminate Chassis
"W" Option N/A	RFT24060BT500P	14088	"G" Option N/A	"M" Option N/A
"W" Option N/A	RFT24054BT500P	12682	"G" Option N/A	"M" Option N/A
"W" Option N/A	RFT21660BT500P	12682	"G" Option N/A	"M" Option N/A
"W" Option N/A	RFT21654BT500P	11418	"G" Option N/A	"M" Option N/A
"W" Option N/A	RFT19254BT500P	8688	"G" Option N/A	"M" Option N/A
"W" Option N/A	RFT16854BT500P	8456	"G" Option N/A	"M" Option N/A
"W" Option N/A	RFT14448BT500P	7726	"G" Option N/A	"M" Option N/A
"W" Option N/A	RFT12048BT500P	7288	"G" Option N/A	"M" Option N/A
"W" Option N/A	RFT9648BT500P	4191	"G" Option N/A	"M" Option N/A
"W" Option N/A	RFT8442BT500P	4033	"G" Option N/A	"M" Option N/A
"W" Option N/A	RFT7236BT500P	3695	"G" Option N/A	"M" Option N/A

## Product Features

- 1.5" thick tops
- Tops and bases are pre-located to ensure proper installation location

### Seating Accommodations

- 240" seats sixteen to eighteen
- 216" seats twelve to fourteen
- 192" seats ten to twelve
- 168" seats ten
- 144" and 120" seats eight to ten
- 96" and 84" seats eight
- 72" seats six

## Options

- Power / data communications support module hardware available in options selection
- Undertop wire trough and channels available in options section

## 2 Select Finish

[Click to view finishes](#)

## 3 Select Edge

[Click to view edges](#)



Flat

Rift

## 4 Select Hardware

[Click to view details](#)

Hardware  
N/A

# Conference - Rift

Top  
Telecom Wedge

[Click here to view statement of line](#)

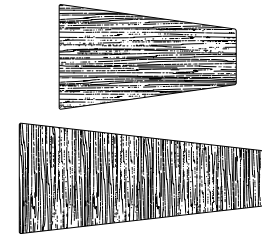

## 1 Select Model

w" x d" x h"	Weight
2 Piece	
144 x 60/30	255
132 x 60/30	240
120 x 54/30	220
1 Piece Top	
96 x 51/30	175
84 x 48/30	135
72 x 42/28	105

Standard Veneer Top Standard Veneer Chassis	Premium Veneer Top Premium Veneer Chassis	High Pressure Laminate Top Veneer Chassis	Thermally Fused Laminate Top Thermally Fused Laminate Chassis
"W" Option N/A	RFT14460WE500P 7726	"G" Option N/A	"M" Option N/A
"W" Option N/A	RFT13260WE500P 7509	"G" Option N/A	"M" Option N/A
"W" Option N/A	RFT12054WE500P 7288	"G" Option N/A	"M" Option N/A
"W" Option N/A	RFT9651WE500P 4191	"G" Option N/A	"M" Option N/A
"W" Option N/A	RFT8448WE500P 4033	"G" Option N/A	"M" Option N/A
"W" Option N/A	RFT7242WE500P 3695	"G" Option N/A	"M" Option N/A

## Product Features

- 1.5" thick tops
- Tops and bases are pre-located to ensure proper installation location

## Notes

- Contact Customer Service for Base Suggestions
- Seating Accommodations
  - 144" and 120" seats eight to ten
  - 132" and 120" seats eight to ten
  - 108", 96" and 84" seats eight
  - 72" seats four to five

## Options

- Power / data communications support module hardware available in options selection
- Undertop wire trough and channels available in options section

## 2 Select Finish

[Click to view finishes](#)

## 3 Select Edge

[Click to view edges](#)



## 4 Select Hardware

[Click to view details](#)

Hardware  
N/A

# Conference - Rift

Top  
Midship

[Click here to view statement of line](#)

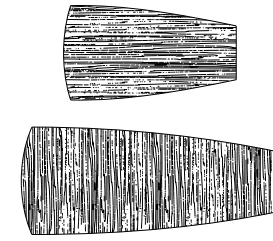

## 1 Select Model

w" x d" x h"	Weight
2 Piece	
144 x 60/30	255
132 x 60/30	240
120 x 54/30	220
1 Piece Top	
96 x 51/30	175
84 x 48/30	135
72 x 42/28	105

Standard Veneer Top Standard Veneer Chassis	Premium Veneer Top Premium Veneer Chassis	High Pressure Laminate Top Veneer Chassis	Thermally Fused Laminate Top Thermally Fused Laminate Chassis
"W" Option N/A	RFT14460MD500P 7726	"G" Option N/A	"M" Option N/A
"W" Option N/A	RFT13260MD500P 7509	"G" Option N/A	"M" Option N/A
"W" Option N/A	RFT12054MD500P 7288	"G" Option N/A	"M" Option N/A
"W" Option N/A	RFT9651MD500P 4191	"G" Option N/A	"M" Option N/A
"W" Option N/A	RFT8448MD500P 4033	"G" Option N/A	"M" Option N/A
"W" Option N/A	RFT7242MD500P 3695	"G" Option N/A	"M" Option N/A
TBCO TBSW TSTV TSMV TSLV TOBW			
Hardware N/A			

## Product Features

- 1.5" thick tops
- Tops and bases are pre-located to ensure proper installation location

## Notes

- Contact Customer Service for Base Suggestions
- Seating Accommodations
- 144" seats ten
- 132" and 120" seats eight to ten
- 96" and 84" seats six to eight
- 72" seats four to five

## Options

- Power / data communications support module hardware available in options selection
- Undertop wire trough and channels available in options section

## 2 Select Finish

[Click to view finishes](#)

## 3 Select Edge

[Click to view edges](#)

## 4 Select Hardware

[Click to view details](#)

# Conference - Rift

Bases

Stationary Base

[Click here to view statement of line](#)

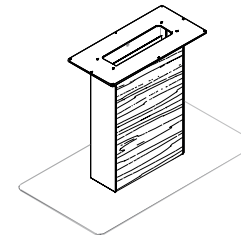

## 1 Select Model

w" x d" x h"

42 x 22

25 x 12

Weight

110

100

Standard Veneer Top Standard Veneer Chassis	Premium Veneer Top Premium Veneer Chassis	High Pressure Laminate Top Veneer Chassis	Thermally Fused Laminate Top Thermally Fused Laminate Chassis
"W" Option N/A "W" Option N/A	RFB4222MB986P 3047 RFB2512MB986P 2330	"G" Option N/A "G" Option N/A	"M" Option N/A "M" Option N/A
	Edge N/A		
	Hardware N/A		

## Product Features

- Steel column base with accent wood panel insert
- Steel platform base with self-leveling cushion bottom
- Wood panel sides attach with magnet and are easily removable for wire access

## Notes

- Power units can not be specified over base. Wire trough is required if power units are ordered

## 2 Select Finish

[Click to view finishes](#)

## 3 Select Edge

[Click to view edges](#)

## 4 Select Hardware

[Click to view details](#)



# Conference - Rift

Bases  
Adjustable Height Base

[Click here to view statement of line](#)

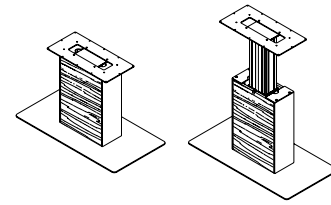

conference height   bar height

## 1 Select Model

w" x d" x h"

42 x 22	110
25 x 12	100

Weight

Standard Veneer Top Standard Veneer Chassis	Premium Veneer Top Premium Veneer Chassis	High Pressure Laminate Top Veneer Chassis	Thermally Fused Laminate Top Thermally Fused Laminate Chassis
"W" Option N/A "W" Option N/A	RFB4222MB987P    5940 RFB2512MB987P    5224	"G" Option N/A "G" Option N/A	"M" Option N/A "M" Option N/A
	Edge N/A		
	Hardware N/A		

## Product Features

- Electronic mechanism with programmable lift
- Steel column base with accent wood panel insert
- Steel platform base with self-leveling cushion bottom
- Wood panel sides attach with magnet and are easily removable for wire access

## Notes

- Power units can not be specified over base. Wire trough is required if power units are ordered

## Options

- Bases
- Linking Cable
- LINK2: Linking cable: Linkage for two base tables - \$185
  - LINK3: Linking cable: Linkage for three base tables - \$315

## 2 Select Finish

[Click to view finishes](#)

## 3 Select Edge

[Click to view edges](#)

## 4 Select Hardware

[Click to view details](#)

# Conference - Rift

Credenzas  
Buffet Credenza

[Click here to view statement of line](#)

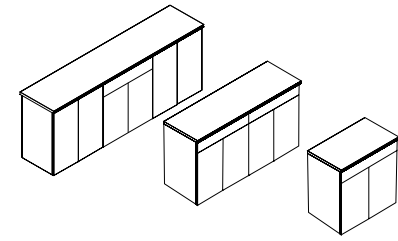

### 1 Select Model

w" x d" x h"	Weight
Triple Buffet 96 x 22 x 36	490
Double Buffet 72 x 22 x 36	340
Single Buffet 36 x 22 x 36	170

	Standard Veneer Top Standard Veneer Chassis	Premium Veneer Top Premium Veneer Chassis	High Pressure Laminate Top Veneer Chassis	Thermally Fused Laminate Top Thermally Fused Laminate Chassis
"W" Option N/A	RFT9622CA126P	8968	"G" Option N/A	"M" Option N/A
"W" Option N/A	RFT7222CA126P	7021	"G" Option N/A	"M" Option N/A
"W" Option N/A	RFT3622CA126P	3579	"G" Option N/A	"M" Option N/A

### 2 Select Finish

[Click to view finishes](#)

### 3 Select Edge

[Click to view edges](#)

### 4 Select Hardware

[Click to view details](#)

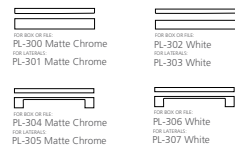

### Product Features

- Floor levelers
- Storage cabinet w/ adjustable wood shelf
- Utility drawer w/ felt liner

### Options

- Accessories
- REF-01: Modify Storage section for refrigerator - \$205
- Door
- D2: Wood Door Lock - \$100 per door set
  - D2: Wood Drawer Lock - \$100 per drawer Set
- Open Plan \_ Finished Back
- OPB: "W" "G" Style - Modify Unit for Open Plan Application - \$195
- Top
- Clear Top
- CCG-36: clear glass on metal standoffs for 36 degree credenza--\$725 list.
  - CCG-72: clear glass on metal standoffs for 72 degree credenza--\$1,225 list.
  - CCG-96: clear glass on metal standoffs for 96 degree credenza--\$1,650 list.
- Frosted Top
- CFG-36: frosted glass on metal standoffs for 36 degree credenza--\$900 list.
  - CFG-72: frosted glass on metal standoffs for 72 degree credenza--\$1,590 list.
  - CFG-96: frosted glass on metal standoffs for 96 degree credenza--\$2,115 list.
- Trash Can
- TRC50: EZ Cargo 50 dual trash can - (1) 8 gallon and (1) 5 gallon - \$680

# Conference - Rift

Credenzas  
Storage Credenza

[Click here to view statement of line](#)

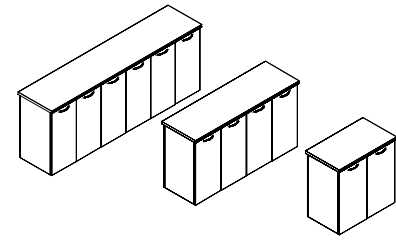

## 1 Select Model

w" x d" x h"	Weight
Triple Storage 96 x 22 x 36	480
Double Storage 72 x 22 x 36	330
Single Storage 36 x 22 x 36	165

	Standard Veneer Top Standard Veneer Chassis	Premium Veneer Top Premium Veneer Chassis	High Pressure Laminate Top Veneer Chassis	Thermally Fused Laminate Top Thermally Fused Laminate Chassis
"W" Option N/A	RFT9622CA124P	8807	"G" Option N/A	"M" Option N/A
"W" Option N/A	RFT7222CA124P	6599	"G" Option N/A	"M" Option N/A
"W" Option N/A	RFT3622CA124P	3368	"G" Option N/A	"M" Option N/A

## 2 Select Finish

[Click to view finishes](#)

## 3 Select Edge

[Click to view edges](#)

## 4 Select Hardware

[Click to view details](#)

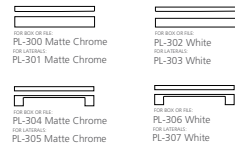

## Product Features

- Adjustable black shelf per door section
- Floor levelers

## Options

- Accessories
- MTL30-S: Silver metal legs - \$315 unit
  - MTL30-W: White metal legs - \$420 unit
  - REF-01: Modify Storage section for refrigerator - \$205
- Door
- D2: Wood Door Lock - \$100 per door set
- Open Plan \_ Finished Back
- OPB: "W" "G" Style - Modify Unit for Open Plan Application - \$195
- Top
- Clear Top
- CCG-36: clear glass on metal standoffs for 36 degree credenza--\$725 list.
  - CCG-72: clear glass on metal standoffs for 72 degree credenza--\$1,225 list.
  - CCG-96: clear glass on metal standoffs for 96 degree credenza--\$1,650 list.
- Frosted Top
- CFG-36: frosted glass on metal standoffs for 36 degree credenza--\$900 list.
  - CFG-72: frosted glass on metal standoffs for 72 degree credenza--\$1,590 list.
  - CFG-96: frosted glass on metal standoffs for 96 degree credenza--\$2,115 list.

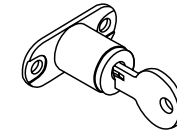
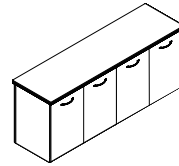

DOOR MODIFICATIONS  
soft close door hinge

Style Number	List Price
D9SC	20 Per door

DOOR MODIFICATIONS  
delete doors/replace black laminate  
shelf w/ finished shelf

Style Number	List Price
D6A	N/C

DOOR MODIFICATIONS  
panel door lock

Style Number	List Price
D2	100 Per door set

Specifications

- Snap onto standard door hinge
- Requires (2) per door
- Max door height 43"
- Factory installed where specified
- Individually shipped for field installation

Notes  
- Specify Each Item To Have Slow Close Feature

Specifications

- Delete doors and replace black laminate shelf with finished shelf

Notes  
- Available on: Storage "W"/"G" Style Credenzas

Specifications

- Door Locks - 1 Door w/ Lock, Other Door w/ Catch Latch
- Contact Customer Service regarding limited lock locations and keying.

Notes  
- Available on: Panel Doors, Wood Frame Doors, and Silverluma doors

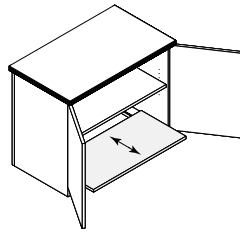

**PEDESTAL MODIFICATIONS**  
black laminate printer pullout  
bottom shelf

Style Number	List Price
PPOS	225

**Specifications**

- Black Laminate pullout shelf on suspension
- Black grommet
- Adjustable Shelf

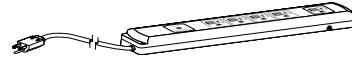

**POWER / DATA**  
power supply cordset

Style Number	List Price
PD717	100

**Specifications**

- SIZE: 10.75"L x 2.0"W x 1.06"H
- (5) Outlets w/ 10' cord
- Surge suppression (720 Joules)
- 15 Amp breaker
- Available on: Vertical Panels, Cabinet Interiors, and under tops

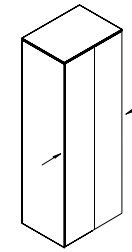

**PRODUCT MODIFICATIONS**  
modify width - open/closed storage

Style Number	List Price
MOD-2	250

**Specifications**

- Modify width down on any unit with open or closed storage section: overheads, wall hung units, storage credenzas, towers

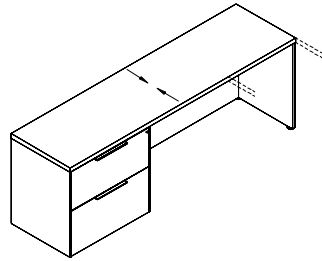

PRODUCT MODIFICATIONS  
 modify width - outside of mod-1,  
 mod-2

Style Number	List Price
MOD-3	Contact for pricing

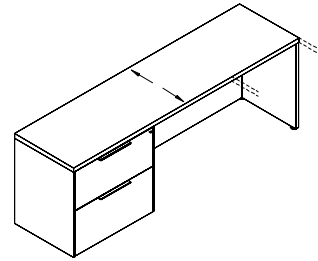

PRODUCT MODIFICATIONS  
 modify depth - decrease depth

Style Number	List Price
MOD-5	125

PRODUCT MODIFICATIONS  
 modify depth - increase depth

Style Number	List Price
MOD-6	Add 10%

PRODUCT MODIFICATIONS  
 modify height

Style Number	List Price
MOD-7	Contact for pricing

### Specifications

- Width modification outside of MOD-1 & MOD-2

### Specifications

- Modify depth down (minimum depth for a unit with drawers is 21"D)

Notes  
 - Ex. 24" to 21", 30" to 24", and 36" to 30"

### Specifications

- Increase depth by no more than 6"

Notes  
 - Ex. 24" to 30", 30" to 36", and 36" to 42"  
 - Add 10% to the unit you want to increase the depth of by no more than 6"

### Specifications

- Modify height of a unit

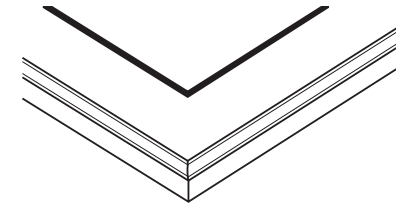
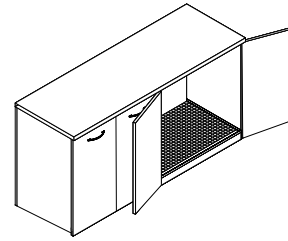

**PRODUCT MODIFICATIONS**  
modify conference table length and width - 1 piece top

Style Number	List Price
MOD-8	125

**PRODUCT MODIFICATIONS**  
modify conference table length and width - 2/3 piece top

Style Number	List Price
MOD-9	250

**REFRIGERATOR MODIFICATION**  
refrigerator cabinet modification

Style Number	List Price
REF01	205

**SPECIALTY VENEER ACCENTS**  
black ebony wood inlay in one piece conference top

Style Number	List Price
One Piece Conference Top	
T30 Two Piece Conference Top	Contact for Pricing
T31	Contact for Pricing

**Specifications**

- Modify length/width on a 1 piece table top

**Specifications**

- Modify length/width on a 2 or 3 piece table top

**Specifications**

- Open back cutout for venting
- Moisture sponge mat
- Contaminate ledge
- Contact customer service for maximum refrigerator size (Changes based on unit).

Notes  
- Available on: 36" and 42" Storage Credenzas

**Specifications**

- Standard veneer top is routed for Ebony wood inlay 1/8" x 3/16" width line. Inlay wood is miter jointed in the corners, hand fitted, glued and sanded flush with top veneer. Inlay forms a 3" border to top edge

Notes  
- Hand fitted miter corner Black Ebony wood inlay installed in standard wood veneer tops

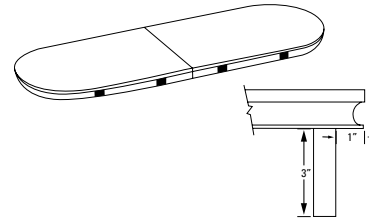
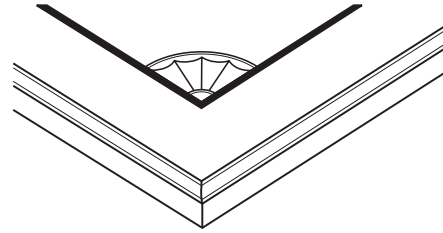
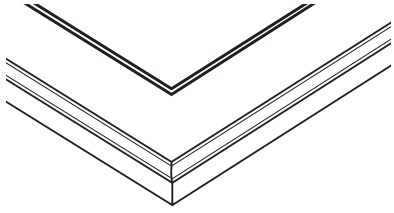

**SPECIALTY VENEER ACCENTS**  
black/white/black wood inlay

**SPECIALTY VENEER ACCENTS**  
black ebony wood inlay w/ wood fan detail - 1 piece conference table top

**TOP MODIFICATION**  
top apron rail

**TOP MODIFICATION**  
top apron rail

Style Number	List Price
One Piece Top T30BWB	Contact for Pricing
Two Piece Top T31BWB	Contact for Pricing

Style Number	List Price
One Piece Top T51	Contact for Pricing
Two Piece Top T52	Contact for Pricing

Style Number	List Price
TAR	Add 10% to top price for apron only to top

Style Number	List Price
TAR-M	Add 15% (Apron rail with beltline detail)

**Specifications**

- Standard veneer top is routed for wood inlay 1/8" x 3/16" width line. Each color is 1/16" wide. White inlay line is finished over providing a subtle contrast to line detail

**Notes**

- Available on: Conferencing Tops
- Hand fitted miter corner ebony-maple-ebony wood inlay installed in standard veneer top
- The center white line can be masked off preventing color stains from penetrating. Final top coats are applied over the white line.

**Specifications**

- Standard veneer top is routed for wood inlay 1/8" x 3/16" width line. With each 90 degree corner routed for Quarter circle fan inlays. Inlay fans combined with solid black inlay preserves an old traditional appearance. Fans are handcrafted from teakwood, rosewood, mahogany, and other exotic woods. Each piece of veneer is shaded by burning and is hand fitted to a perfect fan shape - truly and old world craft

- Conference tables: 4 fans, one in each corner per top section

**Notes**

- Available on: Conferencing Tops
- Hand fitted miter corner wood inlay and fan installed in standard veneer top
- Only available on square/ rectangle tops

**Specifications**

- 3 x 3/4 thick apron rail is set back under top 1"

- Apron rail is recommended for fixed port installation for power/data support.

**Notes**

- Available on: Conferencing Tops only
- Select power/data support separately.
- See power options for available apron power

**Specifications**

- Traditional with apron rail and molding - available in Cherry and Walnut.

**Notes**

- Available on: Conference tops only
- Select power/data support separately.
- See power options for available apron power



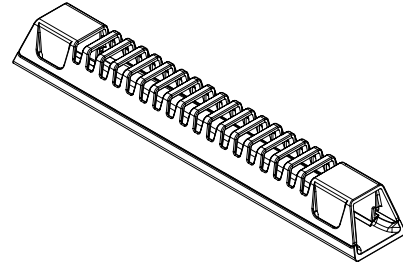
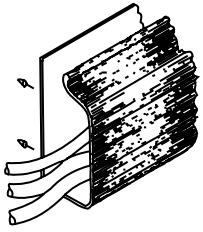

**WIRE MANAGEMENT**  
horizontal j-channel wire  
management raceway

**WIRE MANAGEMENT**  
horizontal wire management  
raceway

**WIRE MANAGEMENT**  
horizontal u-channel wire  
management raceway

**WIRE MANAGEMENT**  
coil wire manager

Style Number	List Price
W1	80 Per 4' section

Style Number	List Price
W21	35

Style Number	List Price
W2A	80 Per 4' section

Style Number	List Price
W18	160

**Specifications**

- 4' section for field installation.
- The "J" shape black thermoplastic wire raceway may be added to specified worksurface tops to provide concealed channeling of wires to and from worksurface grommets. For use in open kneespace areas, raceway is attachable to top of back panel with pan head screws. Interior dimensions are 1" x 1- 1/2" providing ample storage for multiple wires and excess cable. Front of raceway flexes out for easy cord insertion.

- Notes
- Units w/ Wire Channel Standard.
  - Field Installation

**Specifications**

- 10"W x 1.5"D x 1.25"H
- Grey Wire Manager (10.5")
- Power and data cables can be discretely housed and managed with the W21 Gray Wire Manager. This can be mounted in any location to metal frame or underside of conference tables and runs cables through a 1" channel from power module to hollow steel legs. This keeps cables organized under the table top. Release clips make it simple to snap on and off the Wire Manager for easy organization and access after attached to the table

- Notes
- Field installed

**Specifications**

- 4' section for field installation.

- Notes
- Units w/ Wire Channel Standard.
  - Field Installation

**Specifications**

- Weighted Base, Table attachment plate
- 39- 1/2" Length
- Black

- Notes
- Location

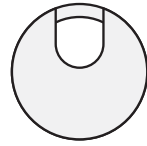
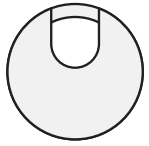

**WIRE MANAGEMENT**  
standard location grommets -  
factory installed

Style Number	List Price
Standard Location Grommet	
Black	
TM30	50
Silver	
TM31	50
Antique Brass	
TM33	50
White	
TM34	50

**WIRE MANAGEMENT**  
non-standard location grommets -  
factory installed

Style Number	List Price
Non-Standard Location Grommet	
Black	
TM30 -NS	95
Silver	
TM31 -NS	95
Antique Brass	
TM33 -NS	95
White	
TM34 -NS	95

**WIRE MANAGEMENT**  
black plastic vertical surface  
grommets - factory installed

Style Number	List Price
Standard Location Grommet	
TM50-C	50
Non-Standard Location Grommet	
TM50-NS	95

**Specifications**

- 1 -5/8" Metal Grommet

Notes

- \*Units w/ Grommets Standard Are Noted Under Standard Features. Grommets Match Pull Finish - Standard (Unless Specified Otherwise)

**Specifications**

- 1 -5/8" Metal Grommet

Notes

- \*Units w/ Grommets Standard Are Noted Under Standard Features. Grommets Match Pull Finish - Standard (Unless Specified Otherwise)

**Specifications**

- 2 " Black Plastic Grommet

Notes

- Standard Location is Bottom Center

Aircharge wireless charging grommet

Style Number	List Price
ACWG WIRELESS GROMMET	\$213

Specifications

- › When used with GROVE Tables an additional \$350 LIST will apply for the special cutout required.
- › AirCharge offers a convenient way to charge any Qi compatible smartphone or device without the need to carry charging cables or find an available power outlet.
- › The Aircharge is powered by the latest Qi compliant IC offering reliable and efficient wireless charging in a convenient 3" grommet hub. Simply place your phone on the Aircharge and an LED will confirm pairing and begin wireless charging.
- › Recess: Efficient space conservation and quick access
- › Input: DC 5V (with included AC power adapter), DC 9V, 1.67A (with optional QC 2.0 power adapter)
- › Output: 5 watts Max. with DC 5V, 2A power adapter, 10 watts Max. with QC 2.0 power adapter
- › Qi V1.2 compliant IC
- › Charging distance: 6mm Max.

Available: All DARRAN collections



Cove power unit - non-linking

Style Number	List Price
 PD-COVE PLUG	\$600
Non-linking version	

### Specifications

- › Size 5.75”L x 2.5”W
- › (2) 15 Amp Receptacles and (2) USB charging ports
- › Surface Mount
- › 108” Cord
- › Standard Silver Finish, Available in White or Black Finish upon request
- › ETL Listed

Available: All DARRAN collections



Cove power unit with daisylink

Style Number                      List Price

STARTER UNITS



COV-DCH HARDWIRED                      \$744

Includes (1) Cove unit with Hardwire Infeed  
- 120"

ADDITIONAL LINKING UNITS

COV-DCL                                      \$627 EACH

Includes Linking Cove unit and Jumper up to  
96", cable length determined by the top size

Specifications

- > Size: 5.75"L x 2.5"W
- > (2) 15 Amp Receptacles and (2) 2.1 Amp USB charging ports
- > Surface Mount
- > Max Daisy Chain - Hardwire - (9) units; Plug/Corded - (4) units
- > Standard Silver Finish, Available in White or Black Finish upon request
- > ETL Listed

Available: All DARRAN collections



Cove corded series

Style Number	List Price
 PD-COVE-PKO	\$872

Specifications

- › Size 9.5”L x 2.5”W x 3.18”D
- › When used with GROVE Tables an additional \$350 LIST will apply for the special cutout required.
- › (2) Power Receptacles, (2) 2.1 Amp USB charging ports and (1) Telecom Plate Knockout
- › Surface Mount
- › 108” Cord
- › Standard Silver Finish, Available in White or Black Finish upon request
- › ETL Listed



Available: All DARRAN collections

Telecom Plates	
RJ45 (1)	\$55
RJ45 (2)	\$110
RJ45 (3)	\$165
USB (1)	\$70
USB (2)	\$140
RJ11/RJ45	\$110
RJ45/USB	\$125
RJ45/HDMI	\$210
HDMI/DVI	\$325
HDMI/USB	\$205
HDMI/VGA	\$240
VGA/MINI-STEREO	\$155
VGA/USB	\$175

This pod can have up to 1 total plates.  
 \*All telecom connectors sold separately.



FPDB flush power/data bay

Style Number	List Price
 Hardwired	
FPDB-H72 72" Cord	\$1363
FPDB-H108 108" Cord	\$1300
FPDB-H144 144" Cord	\$1350
FPDB-H180 180" Cord	\$1400
 Power/Plug	
FPDB-C72 72" Cord	\$1250
FPDB-C108 108" Cord	\$1300
FPDB-C144 144" Cord	\$1350
FPDB-C180 180" Cord	\$1400

Specifications

- › Size 14.19"L x 6.39"W x 3.38"H
- › (4) 15 Amp receptacles
- › Available in white, silver or black
- › (3) telecom plate cutouts standard
- › (1) Dual USB ports
- › Corded units are UL Listed and CSA Certified. Hardwired Units are CSA Certified
- › Select 72", 108", 144", or 180" power cord or hardwire whip cord

Available: All DARRAN collections, excludes rail and grove

Telecom Plates	
RJ45 (1)	\$55
RJ45 (2)	\$110
RJ45 (3)	\$165
USB (1)	\$70
USB (2)	\$140
RJ11/RJ45	\$110
RJ45/USB	\$125
RJ45/HDMI	\$210
HDMI/DVI	\$325
HDMI/USB	\$205
HDMI/VGA	\$240
VGA/MINI-STEREO	\$155
VGA/USB	\$175

This pod can have up to 3 total plates.  
 \*All telecom connectors sold separately.



Standard underside Convenience plug. Can be used for Daisy Chaining up to (4) total units. Specify hardwired or plug for the first unit in series, daisy chained units will have a plug for connection through convenience plug.

Reef power unit with daisylink

Style Number	List Price
 REF310 PLUG	\$1199

Specifications

- › Size 16.1”L x 6.25”W x 4.89”D
- › When used with GROVE Tables an additional \$350 LIST will apply for the special cutout required.
- › (3) 120V Receptacles, (2) USB charging ports, 1 Data Plate Knockout, (2) Knockouts for RJ45 Data Ports
- › Surface Mount
- › 108” Cord
- › Features Convenience Plug on bottom of unit that allows for max (3) Daisy Chain
- › Standard Black Finish, Available in White or Silver Finish upon request
- › Additional Telecom Plate Knockout
- › RJ45 for Knockouts not required. If not ordered a small hole will be present in the pod in this this location
- › ETL Listed

Available: Conferencing

Telecom Plates	
RJ45 (1)	\$55
RJ45 (2)	\$110
RJ45 (3)	\$165
USB (1)	\$70
USB (2)	\$140
RJ11/RJ45	\$110
RJ45/USB	\$125
RJ45/HDMI	\$210
HDMI/DVI	\$325
HDMI/USB	\$205
HDMI/VGA	\$240
VGA/MINI-STEREO	\$155
VGA/USB	\$175

This pod can have up to 1 total plates.  
 \*All telecom connectors sold separately.

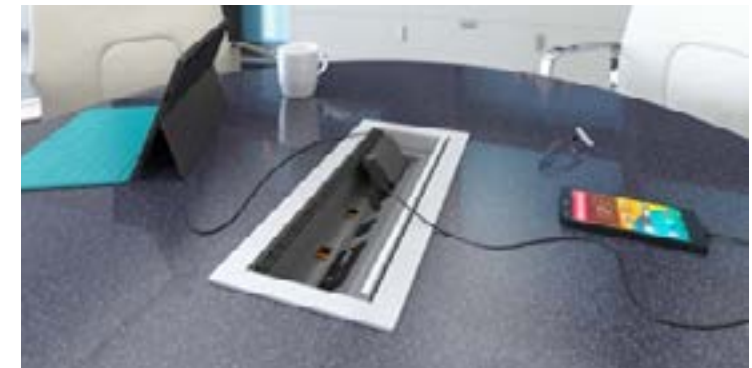



Powered seamless grommet w/ seclusion daisylink

Style Number	List Price
 Power/Plug	
PSG82-C: PLUG	\$2044
* Not Available on Thermally Fused Laminate	

Additional Linking Units

Style Number	List Price
 Power/Plug	
PSG82-L: Linking	\$1590
*Covers up to 120" distance between pods	
* Not Available on Thermally Fused Laminate	

Specifications

- › Grommet comes with 2 Power Pods that are mounted under the Seamless Grommet. Pods daisylink together with (2) innerconnecting cables.
- › Size: 11.5"L x 8.25"W
- › (4) Power Receptacles per power pod, 8 total
- › 144" Power cord
- › Standard Black Finish
- › UL Listed
- › (2) 2.1 Dual USB ports per pod, 4 total
- › (2) Data ports per pod, 4 total

Available: ThinkingQuietly, EdgeWorks, Conferencing

Telecom Plates	
RJ45 (1)	\$55
RJ45 (2)	\$110
RJ45/HDMI	\$210
HDMI/VGA	\$240
RJ45/VGA	\$210

This pod can have up to 1 total plates.  
 \*All telecom connectors sold separately.



### Soba wire manager

Style Number	List Price
STARTER UNITS	
SCDW	\$218
White wire manager	
SCDB	\$218
Black wire manager	

## Specifications

- › Dimensions: 9ft x 9in x 3.15in
- › Zips up, bundles and routes loose, messy cables into a single tube
- › Routes and guides cables behind desks, TVs, and anywhere cables tend to get messy
- › Accommodates large or small cables, up to three cables at once
- › Support channels, used to route cables, include powerful adhesive backing which allows easy attachment to surfaces.

Available: All DARRAN collections



TBB1616CS974 TBB2020CS974 TBB2424CS974 TBB1610HS975 TBB2010HS975 TBB2410HS975 TBB1616CC962 TBB2020CC962 TBB2424CC962 TBB1610CH977 TBB2010CH977 TBB2410CH977 TBB1616TR962 TBB2020TR962 TBB2424TR962 TBB1616TC962 TBB2020TC962 TBB2424TC962 TBB1610TH977 TBB2010TH977 TBB2410TH977 TBB3131PB955

## TABLE SHAPE

### ROUND



36 DIA.  
42 DIA.  
48 DIA.  
54 DIA.  
60 DIA.

### SQUARE



42 x 42  
48 x 48  
54 x 54  
60 x 60

### RECTANGLE



72 x 36  
84 x 42  
96 x 48  
120 x 48  
144 x 48  
168 x 54  
192 x 54  
216 x 54  
216 x 60  
240 x 54  
240 x 60

### ARCH RECTANGLE



### BOAT SHAPE



72 x 36/30  
84 x 42/32  
96 x 48/36  
120 x 48/39  
144 x 48/39  
168 x 54/42  
192 x 54/42  
216 x 54/39  
216 x 60/48  
216 x 54/42  
240 x 60/48

TABLE SHAPE	16"	20"	24"	16"	20"	24"	16"	20"	24"	16"	20"	24"	16"	20"	24"	16"	20"	24"	16"	20"	24"	22"	
ROUND																							1
SQUARE	1						1									1							1
RECTANGLE				2						2										2			2
ARCH RECTANGLE					2						2										2		2
BOAT SHAPE	2			2			2			2			2			2			2				2

\*Bases can be deleted when trough is specified.

# DARRAN<sup>®</sup>

TBB1616WD969 TBB2020WD969 TBB2424WD969 TBB1616TD969 TBB2020TD969 TBB2424TD969 TBB1608HD968 TBB2010HD968 TBB2412HD968 NSS0301MB985 NSS3030MB984 TBB0303MB982 TBB0303MB976 TBB3232MB971 TBB3636MB971 TBB2403MB954 TBB3003MB954 TBB3603MB954 NSS3003MB988 NSS3603MB988 TBB0102MB979 TBB3002MB956 TBB2602MB956 TBB3602MB956 TBB4202MB956 TBB4203MB956

## TABLE SHAPE

### ROUND



	16 DIA.	20 DIA.	24 DIA.	16 DIA.	20 DIA.	24 DIA.	16"	20"	24"	3.75"	30"	3 DIA.	3"	32"	36"	24	30"	36"	30"	36"	2"	30"	26"	36"	42"	42"
W	28.75"	28.75"	28.75"	28.75"	28.75"	28.75"	8"	10"	12"	28.5"	28.5"	27.75"	27.75"	27.75"	27.75"	3"	3"	3"	3"	3"	28.75"	27.75"	27.75"	27.75"	27.75"	27.75"
H	1			1						4	1	4	4	1							4					
36 DIA.	1			1						4	1	4	4	1							4					
42 DIA.		1			1					4	1	4	4	1							4					
48 DIA.		1			1					4	1	4	4		1						4					
54 DIA.			1			1				4	1	4	4								4					
60 DIA.			1			1				4	1	4	4								4					

### SQUARE



42 x 42										4	1	4	4								4					
48 x 48										4	1	4	4								4					
54 x 54										4	1	4	4								4					
60 x 60										4	1	4	4								4					

### RECTANGLE



72 x 36	2			2			2			4		4	4			2			2		4	2	2			
84 x 42		2			2					4	2	4	4	2		2			2		4			2		
96 x 48		2			2						2	6	6		2	2			2		6				2	
120 x 48		2			2						2	6	6		2	3			3		6				3	
144 x 48		2			2						2	6	6		3	3			3		6				3	
168 x 54			3			3											3									3
192 x 54			3			3											4									4
216 x 54			3			3											4									4
216 x 60			3			3												4								4
240 x 54			4			4													6							6
240 x 60			4			4													6							6

### ARCH RECTANGLE



168 x 54			3			3											3									3
192 x 54			3			3											4									4
216 x 54			3			3											4									4
216 x 60			3			3												4								4
240 x 54			4			4													6							6
240 x 60			4			4													6							6

### BOAT SHAPE



72 x 36/30	2			2			2										2			2	2					
84 x 42/32	2			2			2					4	4	2			2			4	2	2				
96 x 48/36		2			2							6	6	2			2			6			2			
120 x 48/39	2+	2		2+	2		2+					6	6		2				3	6					3	
144 x 48/39	2+	2		2+	2		2+					6	6		3				3	6					3	
168 x 54/42	2+			2+			2+																		3	
192 x 54/42	2+			2+			2+																		4	
216 x 54/39	2+			2+			2+																		4	
216 x 60/48	2+			2+			2+																			4
216 x 54/42	2+			2+			2+																		6	
240 x 60/48	2+			2+			2+																			6

\*Bases can be deleted when trough is specified.

# DARRAN

TBB1812TB963  
TBB2412TB963  
TBB1818PX966  
TBB2424PX966  
TBB3030PX966  
TBB5424PB972  
TBB6024PB972  
TBB8424PB972  
TBB10824PB972  
TBB13224PB972  
TBB15624PB972  
TBB18024PB972  
TBB20424PB972  
TBB5424TB972  
TBB6024TB972  
TBB8424TB972  
TBB10824TB972  
TBB13224TB972  
TBB15624TB972  
TBB18024TB972  
TBB20424TB972

W	18"	24"	18"	24"	30"	84"	96"	120"	144"	168"	192"	216"	240"	84"	96"	120"	144"	168"	192"	216"	240"	
H	28.75"	28.75"	28.75"	28.75"	28.75"	28.75"	28.75"	28.75"	28.75"	28.75"	28.75"	28.75"	28.75"	28.75"	28.75"	28.75"	28.75"	28.75"	28.75"	28.75"	28.75"	28.75"

## TABLE SHAPE

### ROUND

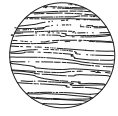

36 DIA.																						
42 DIA.			1																			
48 DIA.			1																			
54 DIA.					1																	
60 DIA.																						

### SQUARE



42 x 42			1																			
48 x 48			1																			
54 x 54					1																	
60 x 60																						

### RECTANGLE



72 x 36	2		2																			
84 x 42		2		2		1								1								
96 x 48		2		2			1								1							
120 x 48		2+		3				1								1						
144 x 48		2+		3					1								1					
168 x 54					3					1								1				
192 x 54					3						1										1	
216 x 54					3							1								1		
216 x 60												1								1		
240 x 54													1									1
240 x 60													1									1

### ARCH RECTANGLE



72 x 36/30	2																					
84 x 42/32	2					1								1								
96 x 48/36		2		2			1								1							
120 x 48/39		2+		2				1								1						
144 x 48/39		2+		3					1								1					
168 x 54/42				2+						1								1				
192 x 54/42				2+							1									1		
216 x 54/39				2+								1									1	
216 x 60/48												1									1	
216 x 54/42					2+							1									1	
240 x 60/48												1									1	

### BOAT SHAPE



RFB2512/MB986

RFB4222/MB986

## TABLE SHAPE

### BOAT



	RFB2512/MB986	RFB4222/MB986
72 x 36	2	
84 x 42	2	
96 x 48	2	
120 x 48	3	
144 x 48	3	
168 x 54		3
192 x 54		3
216 x 54		4
216 x 60		4
216 x 54		4
240 x 60		4

### RECTANGLE

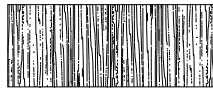

	RFB2512/MB986	RFB4222/MB986
72 x 36	2	
84 x 42	2	
96 x 48	2	
120 x 48	3	
144 x 48	3	
168 x 54		3
192 x 54		3
216 x 54		4
216 x 60		4
240 x 54		4
240 x 60		4