

DARRAN®



Nika Price List

Effective June 9, 2023

Designed By Bill Raftery

| Date | Page | Modification | Description |
|----------|------|--------------------------|-------------|
| 10.12.23 | | Added Kvadrat | |
| 01.26.24 | 4 | Added Disclaimer callout | |

Statement of Line

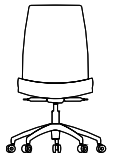

Page 5
Armless
Mid-Back



Page 6
Armless
High-Back

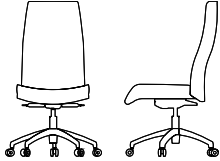

Page 7
Adjustable Ergonomic Arms
Mid-Back



Page 8
Adjustable Ergonomic Arms
High-Back



Page 9
Polished Aluminum Arm
Mid-Back



Page 10
Polished Aluminum Arm
High-Back



Seating & fabric leather program

DARRAN has partnered with some of the most prestigious fabric suppliers of the office furniture industry to bring you quality fabrics that are engaging designs, environmentally friendly and durable for years to come. The majority of fabrics we have graded-in are in heavy supply making it most likely available on our Quickship however, we cannot guarantee stock. If you do not see the fabric you wish to include in a project, please contact Customer Service to see if this pattern can be graded in at 800.334.7891.

Fabrics & Leathers

Please visit our Seating Fabrics page at darran.com/textilesleather

| | |
|---|--|
| Camira www.camirafabrics.com 800.334.789 | Wollsdorf www.wollsdorf.com 336.884.5005 |
| CFStinson www.cfstinson.com 800.841.6279 | Green Hides www.greenhides.com 336.315.9720 |
| DesignTex www.designtex.com 800.797.4949 | Kvadrat www.kvadrat.fabrics.com +45 8953 1866 |
| Maharam www.maharam.com 800.645.3943 | |
| Momentum Textiles www.momentumtextiles.com 800.366.6839 | |
| Ultrafabrics www.ultrafabricsinc.com 800.334.7891 | |

Application instructions must be specified on the purchase order or COM / COL submission form. In the absence of application instructions, DARRAN will apply materials accordingly.

CAL117

All DARRAN seating products conform to California Technical Bulletin 117 as a minimum standard.

CAL133

To meet the California Technical Bulletin 133 flammability regulation, a combination of proper materials must be used to pass, as it tests the fire resistance of a finished product. Flame resistant fabric, a fire blocker material and special foam must be used to pass CAL133 fire codes.

Testing is available for all seating products with the following fees and considerations:

- If laboratory certification is not required, any style can be manufactured to comply with California Technical Bulletin 133 for \$75 list per yard required. (Customer's Own Materials must factor in additional yardage requirements based on repeat.)
- The purchase order must clearly indicate the requirement of California Technical Bulletin 133
- If laboratory California Technical Bulletin 133 certification is required, the cost of testing a chair is \$820 NET, plus the cost of the chair and covering material.
- An additional lead time of 4 to 6 weeks is required for testing for CAL133.
- Once testing is completed, we will provide a certification letter specific to the sample tested for CAL133.
- DARRAN's manufacturing procedures for California TB 133 compliance are based on the testing of representative style with specific fabrics. Please contact Customer Service for an updated list of tested models.
- A copy of test certification is available upon request.

Combination fabrics

DARRAN is pleased to offer customers the design freedom of combination fabrics. When using fabric, vinyl or leather combinations, pricing will be as follows:

- When combining two materials of the same grade, pricing will be specified grade + 5%.
- If combining two materials of different grades or leather/ fabric combination, use the highest grade/price + 5%.
- If using COM or COL, pricing will be COM or COL + 5%. If both COM + COL are used in combination, use COL + 5%

COM/COL ordering instructions

Please complete the COM Submission Form prior to ordering the fabric from the supplier. All COM fabrics must be approved prior to order submission. Please refer to our website or contact DARRAN Seating Customer Service for an updated list of preapproved COM fabrics. Application instructions must be specified on the purchase order or COM/COL approval form. In the absence of application instructions, DARRAN will apply materials in the best manner and cannot be held responsible for tailoring or application objections after upholstery. COM orders will be scheduled for production after receipt of the material. Packages must be clearly marked and the fabric must be first quality, continuous yardage.

COM/COL yardage requirements

The yardage requirements stated in this price list for each style are calculated using 54" wide, non-directional fabrics. For fabrics with a different width or for patterns with repeats, please refer to the below chart to calculate the additional percent of fabric required:

| Fabric Width | Plain Fabric | 2" - 14" Repeat | 15" - 19" Repeat | 20" - 27" Repeat | 28" - 36" Repeat |
|--------------|--------------|-----------------|------------------|------------------|------------------|
| 54" | 0 | 15% | 20% | 25% | 30% |
| 53" | 6% | 19% | 24% | 28% | 36% |
| 52" | 13% | 23% | 28% | 33% | 38% |
| 51" | 19% | 26% | 31% | 36% | 41% |
| 50" | 25% | 30% | 35% | 40% | 45% |
| 49" | 30% | 35% | 40% | 45% | 50% |
| 48" | 35% | 40% | 45% | 50% | 55% |
| 47" | 45% | 50% | 55% | 58% | 65% |

DARRAN®

Nika Seating Fabric & Leather Program

NOTE: Prior To Completion Of This Form, Please Refer To Our Graded In Materials Program For Preapproved Fabrics/Leathers.

COM/COL Approval

DARRAN Furniture Industries
2402 Shore Street, High Point, NC 27263
ATTN: Seating Division / COM/COL Approval
TAG: DARRAN Quote Number

Shipping approved COM/COL materials

DARRAN Furniture Industries
2402 Shore Street, High Point, NC 27263
ATTN: Seating Division / COM/COL Approval
TAG: DARRAN Quote Number

Please complete this form, attach a 6"x 6" sample and mail to the COM/COL APPROVAL address shown above.
This form can also be downloaded from our website at www.darran.com/leathers OR www.darran.com/fabrics

Quote # _____

Dealer's Name _____

Contact _____

Address _____

Telephone _____

Email _____

Chair Style _____

Manufacturer _____

Pattern Name _____

Pattern Color _____

Content _____

Repeat _____

Please specify any special requirements and check the application above.

ATTACH 6" X 6" FABRIC/LEATHER SAMPLE HERE

NOTE
Actual Fabric/Leather samples needed instead of digital images. If digital images are sent in lieu of samples, DARRAN will only verify the pattern and will not take responsibility for color variances that cannot be verified due to printing limitations.

In the absence of application instructions, DARRAN will apply the material in the best manner and cannot be held responsible for tailoring or application objections after upholstering.

Unless otherwise instructed on the purchase order, excess COM materials will be recycled at the discretion of DARRAN after six months of the original product ship date.

The COM approval solely pertains to the application of the fabric onto the specified DARRAN seating product. DARRAN's approval or acceptance does not constitute any responsibility or warranty to the overall appearance, durability, flammability, defects, dye lot variations or colorfastness of the COM. It is the customer's responsibility to ensure the COM meets CAL 117 compliance and are first quality continuous goods.

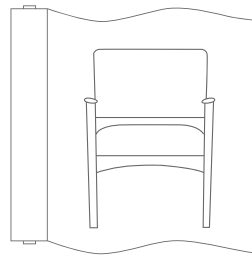

RAILROAD

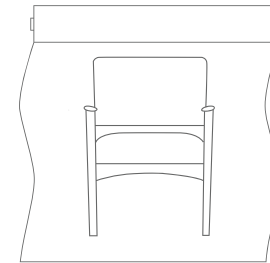

SETUP

DARRAN®

Nika Seating Specification

Width = 26"
Depth = 25"
Height = 35"-39"
Seat Width = 20-1/2"
Seat Depth = 19"
Seat Height = 18 - 22"
Arm Height = 26.5" - 30.5"

Frame Construction: Hardwood
Plywood components are precision cut on CNC routers and feature interlocking tab joinery for superior strength and long term durability. All joints are assembled utilizing glue and steel fasteners.

Cushioning: Back utilizes an elastic sheet webbing suspension that conforms to individual's lumbar curvatures for adaptive support. Cushioning materials are laminations or CAL117 rated high-density polyurethane foams of varying compression rates, providing durability and long terms comfort.

Polished Aluminum Arms.

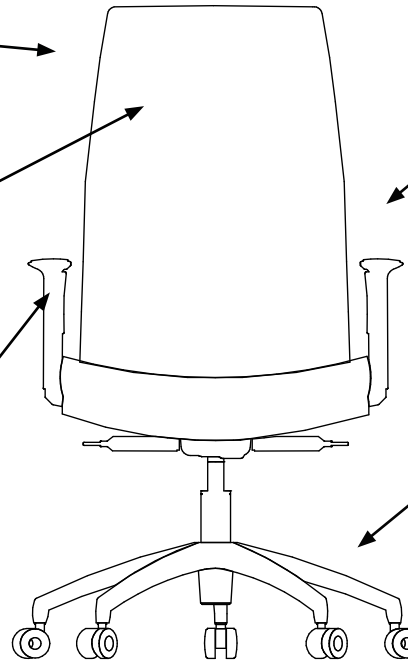

Black ergonomic arms are adjustable providing comfort for varied body types.

Bases: 26" diameter, available in Black Standard or Polished Aluminum.

Casters: 60mm diameter wheels are standard and promote increased mobility.

Carpet casters are standard. For hard floor surfaces specify CST20 - no upcharge.

* Flange stitch may not be available on all textiles/vinyls. DARRAN will use its discretion, using a top stitch detail in cases where the thickness or stiffness prevents an acceptable appearance with the flange stitching detail.

Whether it is used for the elevated environments of the executive boardroom, or the individual workstations associated with essential personnel, the Nika Conference/Task chair has the poise and elegance to win in any location. Designed to stand apart from other products in this category, the Nika incorporates subtle details in its architecture and ergonomics that create a highly effective and elegant option to what is typically found on the market. The slim profile of Nika is sculpted to accept the human form and offer an excellent degree of comfort within a considered footprint. Neither too small nor too big, the Nika in all its versions is an outstanding option to the typical ergonomic task chair as well as being an elegant solution to the standard executive boardroom conference chair. The name Nika is derived from the Greek word nike, so no matter where you use it, it is a win.

Nika

Armless
Mid-Back

[Click here to view statement of line](#)

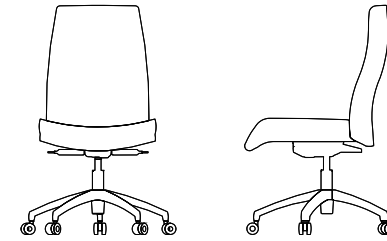

1 Model NIK9925NAM00

w" x d" x h"
26" x 25" x 35"-39"
Arm Height N/A
Seat Height 18" - 22"
Inside Seat Depth 19"
Inside Seat Width 20 -1/2"

| COM | COL | 1 | 2 | 3 | 4 | 5 | 6 | 7 | 8 | 9 | 10 | 11/L1 | 12 | 13/L2 |
|------|------|------|------|------|------|------|------|------|------|------|------|-------|------|-------|
| 1466 | 1503 | 1540 | 1577 | 1614 | 1651 | 1688 | 1725 | 1762 | 1799 | 1836 | 1873 | 1910 | 1947 | 2021 |

Upholstery Requirements
Fabric yds: 2 Leather Sq. Ft.: 36
Carton Weight:

Product Features

- Black Polymer base standard
- Formed plywood shell offers slim profile with contoured comfort
- Synchro-Tilt mechanism allows users to be more mobile during seated worktime

2 Select Finish

[Click to view finishes](#)

Finishes N/A

3 Combination Fabrics

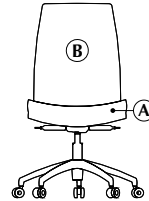

DARRAN is pleased to offer customers the design freedom of combination fabrics. When using fabric, vinyl or leather combinations, pricing/yardage requirements will be as follows:

- A Seat 1 yd(s).
- B Back 1.5 yd(s).

- When combining two materials of the same grade, pricing will be specified grade + 5%
- If combining two materials of different grades or leather/fabric combination, use the highest grade/price + 5%
- If using COM or COL, pricing will be COM or COL + 5%.
- If both COM + COL are used in combination, use COL + 5%.

Options

Base

- POL: Polished Aluminum Base - \$88

Nika

Armless
High-Back

[Click here to view statement of line](#)

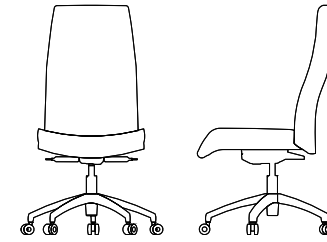

1 Model NIK9925NAH01

w" x d" x h"
26" x 25" x 39"-43"
Arm Height N/A
Seat Height 18" - 22"
Inside Seat Depth 19"
Inside Seat Width 20 -1/2"

| COM | COL | 1 | 2 | 3 | 4 | 5 | 6 | 7 | 8 | 9 | 10 | 11/L1 | 12 | 13/L2 |
|------|------|------|------|------|------|------|------|------|------|------|------|-------|------|-------|
| 1581 | 1627 | 1673 | 1719 | 1765 | 1811 | 1857 | 1903 | 1949 | 1995 | 2041 | 2087 | 2133 | 2179 | 2271 |

Upholstery Requirements
Fabric yds: 2.5 Leather Sq. Ft.: 45
Carton Weight:

Product Features

- Black Polymer base standard
- Formed plywood shell offers slim profile with contoured comfort
- Synchro-Tilt mechanism allows users to be more mobile during seated worktime

2 Select Finish

[Click to view finishes](#)

Finishes N/A

3 Combination Fabrics

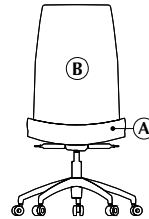

DARRAN is pleased to offer customers the design freedom of combination fabrics. When using fabric, vinyl or leather combinations, pricing/yardage requirements will be as follows:

- A Seat 1 yd(s).
- B Back 1.5 yd(s).

- When combining two materials of the same grade, pricing will be specified grade + 5%
- If combining two materials of different grades or leather/fabric combination, use the highest grade/price + 5%
- If using COM or COL, pricing will be COM or COL + 5%.
- If both COM + COL are used in combination, use COL + 5%.

Options

Base

- POL: Polished Aluminum Base - \$88

Nika

Adjustable Ergonomic Arms
Mid-Back

[Click here to view statement of line](#)

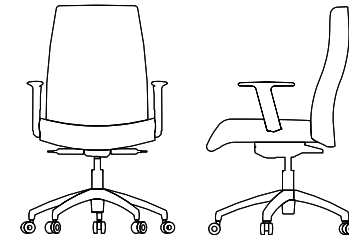

1 Model NIK9925AAM02

w" x d" x h"
26" x 25" x 35"-39"
Arm Height 26.5"-30.5"
Seat Height 18" - 22"
Inside Seat Depth 19"
Inside Seat Width 20 -1/2"

| COM | COL | 1 | 2 | 3 | 4 | 5 | 6 | 7 | 8 | 9 | 10 | 11/L1 | 12 | 13/L2 |
|------|------|------|------|------|------|------|------|------|------|------|------|-------|------|-------|
| 1589 | 1626 | 1663 | 1700 | 1737 | 1774 | 1811 | 1848 | 1885 | 1922 | 1959 | 1996 | 2033 | 2070 | 2144 |

Upholstery Requirements
Fabric yds: 2 Leather Sq. Ft.: 36
Carton Weight:

2 Select Finish

[Click to view finishes](#)

Finishes N/A

3 Combination Fabrics

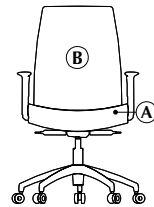

DARRAN is pleased to offer customers the design freedom of combination fabrics. When using fabric, vinyl or leather combinations, pricing/yardage requirements will be as follows:

A Seat 1 yd(s).
B Back 1.5 yd(s).

- When combining two materials of the same grade, pricing will be specified grade + 5%
- If combining two materials of different grades or leather/fabric combination, use the highest grade/price + 5%
- If using COM or COL, pricing will be COM or COL + 5%.
- If both COM + COL are used in combination, use COL + 5%.

Product Features

- Black Polymer base standard
- Formed plywood shell offers slim profile with contoured comfort
- Black ergonomic arms are adjustable providing comfort for varied body types
- Synchro-Tilt mechanism allows users to be more mobile during seated worktime

Options

Base

- POL: Polished Aluminum Base and Arms - \$88

Nika

Adjustable Ergonomic Arms
High-Back

[Click here to view statement of line](#)

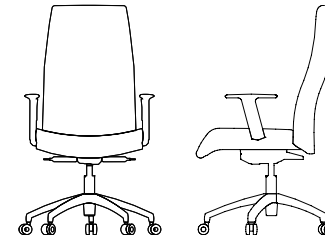

1 Model NIK9925AAH03

w" x d" x h"
26" x 25" x 39"-43"
Arm Height 26.5"-30.5"
Seat Height 18" - 22"
Inside Seat Depth 19"
Inside Seat Width 20 -1/2"

| COM | COL | 1 | 2 | 3 | 4 | 5 | 6 | 7 | 8 | 9 | 10 | 11/L1 | 12 | 13/L2 |
|------|------|------|------|------|------|------|------|------|------|------|------|-------|------|-------|
| 1662 | 1708 | 1754 | 1800 | 1846 | 1892 | 1938 | 1984 | 2030 | 2076 | 2122 | 2168 | 2214 | 2260 | 2352 |

Upholstery Requirements
Fabric yds: 2.5 Leather Sq. Ft.: 45
Carton Weight:

2 Select Finish

[Click to view finishes](#)

Finishes N/A

3 Combination Fabrics

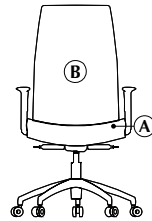

DARRAN is pleased to offer customers the design freedom of combination fabrics. When using fabric, vinyl or leather combinations, pricing/yardage requirements will be as follows:

A Seat 1 yd(s).
B Back 1.5 yd(s).

- When combining two materials of the same grade, pricing will be specified grade + 5%
- If combining two materials of different grades or leather/fabric combination, use the highest grade/price + 5%
- If using COM or COL, pricing will be COM or COL + 5%.
- If both COM + COL are used in combination, use COL + 5%.

Product Features

- Black Polymer base standard
- Formed plywood shell offers slim profile with contoured comfort
- Black ergonomic arms are adjustable providing comfort for varied body types
- Synchro-Tilt mechanism allows users to be more mobile during seated worktime

Options

Base

- POL: Polished Aluminum Base and Arms - \$88

Nika

Polished Aluminum Arm
Mid-Back

[Click here to view statement of line](#)

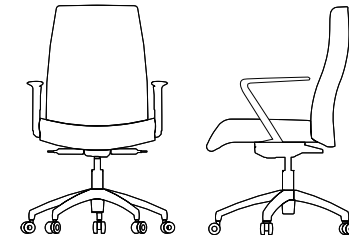

1 Model NIK9925AAM14

w" x d" x h"
26" x 25" x 35"-39"
Arm Height 26.5"-30.5"
Seat Height 18" - 22"
Inside Seat Depth 19"
Inside Seat Width 20 -1/2"

| COM | COL | 1 | 2 | 3 | 4 | 5 | 6 | 7 | 8 | 9 | 10 | 11/L1 | 12 | 13/L2 |
|------|------|------|------|------|------|------|------|------|------|------|------|-------|------|-------|
| 1677 | 1714 | 1751 | 1788 | 1825 | 1862 | 1899 | 1936 | 1973 | 2010 | 2047 | 2084 | 2121 | 2158 | 2232 |

Upholstery Requirements
Fabric yds: 2 Leather Sq. Ft.: 36
Carton Weight:

2 Select Finish

[Click to view finishes](#)

Finishes N/A

3 Combination Fabrics

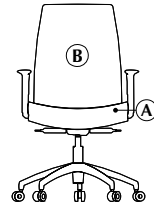

DARRAN is pleased to offer customers the design freedom of combination fabrics. When using fabric, vinyl or leather combinations, pricing/yardage requirements will be as follows:

A Seat 1 yd(s).
B Back 1.5 yd(s).

- When combining two materials of the same grade, pricing will be specified grade + 5%
- If combining two materials of different grades or leather/fabric combination, use the highest grade/price + 5%
- If using COM or COL, pricing will be COM or COL + 5%.
- If both COM + COL are used in combination, use COL + 5%.

Product Features

- Black Polymer base standard
- Formed plywood shell offers slim profile with contoured comfort
- Synchro-Tilt mechanism allows users to be more mobile during seated worktime
- Precision machined polished aluminum arms with comfort support pad built into top of arms

Options

Base

- POL: Polished Aluminum Base and Arms - \$88

Nika

Polished Aluminum Arm
High-Back

[Click here to view statement of line](#)

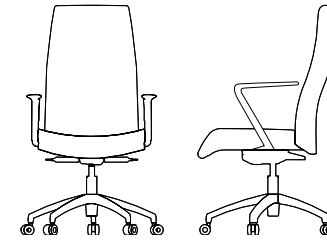

1 Model NIK9925AAH15

w" x d" x h"
26" x 25" x 39"-43"
Arm Height 26.5"-30.5"
Seat Height 18" - 22"
Inside Seat Depth 19"
Inside Seat Width 20 -1/2"

| COM | COL | 1 | 2 | 3 | 4 | 5 | 6 | 7 | 8 | 9 | 10 | 11/L1 | 12 | 13/L2 |
|------|------|------|------|------|------|------|------|------|------|------|------|-------|------|-------|
| 1750 | 1796 | 1842 | 1888 | 1934 | 1980 | 2026 | 2072 | 2118 | 2164 | 2210 | 2256 | 2302 | 2348 | 2440 |

Upholstery Requirements
Fabric yds: 2.5 Leather Sq. Ft.: 45
Carton Weight:

2 Select Finish

[Click to view finishes](#)

Finishes N/A

3 Combination Fabrics

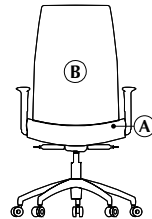

DARRAN is pleased to offer customers the design freedom of combination fabrics. When using fabric, vinyl or leather combinations, pricing/yardage requirements will be as follows:

A Seat 1 yd(s).
B Back 1.5 yd(s).

- When combining two materials of the same grade, pricing will be specified grade + 5%
- If combining two materials of different grades or leather/fabric combination, use the highest grade/price + 5%
- If using COM or COL, pricing will be COM or COL + 5%.
- If both COM + COL are used in combination, use COL + 5%.

Product Features

- Black Polymer base standard
- Formed plywood shell offers slim profile with contoured comfort
- Synchro-Tilt mechanism allows users to be more mobile during seated worktime
- Precision machined polished aluminum arms with comfort support pad built into top of arms

Options

Base

- POL: Polished Aluminum Base and Arms - \$88