

DARRAN®



Prado Price List

Effective April 1, 2024

Designed By David Allan Pessa

Date	Page	Modification	Description
04.03.24		Updated Pricing	

Statement of Line
Features & Advantages1
Finishes | Specifications3
Edges | Pulls | Knobs.....4
Grommets | Grommet Reference.....5
Ganging | Height Reference6
Modesty Reference | Doors | Grain Direction7
Drawer Dimensions | Filing Reference8
Double Pedestal Desk.....9
Table Desk.....11
Single Pedestal Desk.....12
Returns.....14
Bridges17
Freestanding Credenzas18
Workstation Credenzas25
Single Height Freestanding Overheads.....28
Overhead Accessories.....30
Single Height Wall Hung Overheads.....34
Wall Hung Accessories36
Overhead Half Towers.....41
Overhead Bookcases43
Vertical Half Towers.....44
Vertical Full Towers.....45
Bookcases.....48
Options49
Power & Data.....64

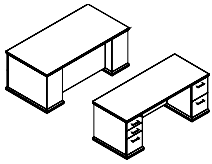

Page 9
Desk
Breakfront - Double Pedestal

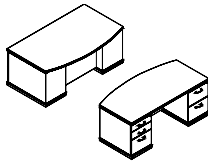

Page 10
Desk
Bowfront / Breakfront Double Pedestal

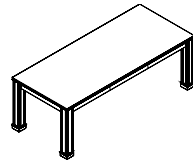

Page 11
Table Desks
Fluted Leg Table Desk

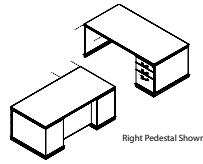

Page 12
Workstation Desks
Breakfront - Single Pedestal

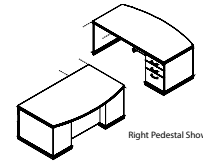

Page 13
Workstation Desks
Bowfront / Breakfront Single Pedestal

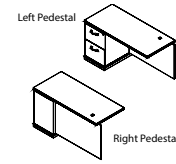

Page 14
Workstation "L" Returns
File / File

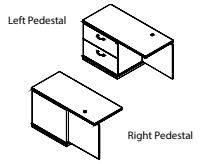

Page 15
Workstation "L" Returns
Lateral File

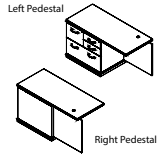

Page 16
Workstation "L" Returns
Multi-File

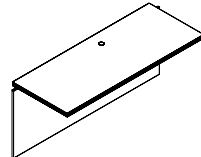

Page 17
Workstation Bridges
Bridge - Fixed Back

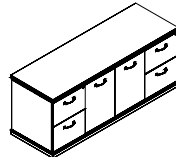

Page 18
Credenzas
File / Storage

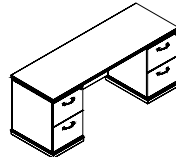

Page 19
Credenzas
Kneespace

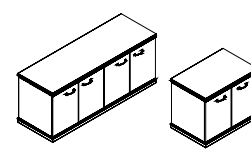

Page 20
Credenzas
Storage Units

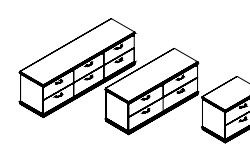

Page 21
Credenzas
Lateral Files



Page 22
Credenzas
Vertical Lateral File

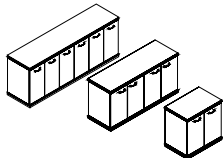

Page 23
Credenzas
Conference Storage

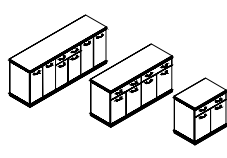

Page 24
Credenzas
Buffet Credenza

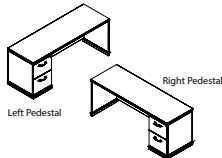

Page 25
Workstation Credenzas
File / File

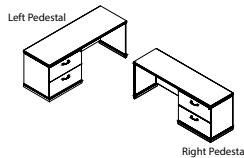

Page 26
Workstation Credenzas
Lateral File

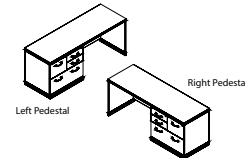

Page 27
Workstation Credenzas
Multi-File

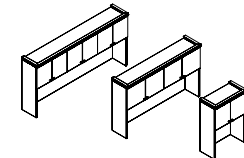

Page 28
Overhead Task
Freestanding Panel Door - 6/4/2 Door

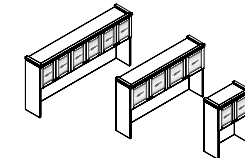

Page 29
Overhead Task
Freestanding Wood Frame Lead-
ed/Beveled Glass Doors

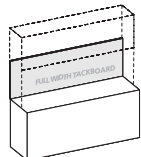

Page 30
Overhead Tackboards

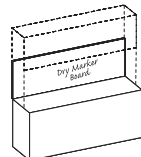

Page 31
Overhead Dry Marker Boards

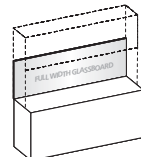

Page 32
Overhead Glassboards

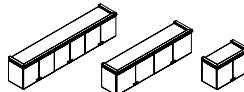

Page 33
Wall Hung Cabinets
Single Height Panel Doors - 6/4/2 Door

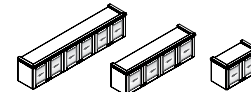

Page 34
Wall Hung Cabinets
Single Height Wood Frame Lead-
ed/Beveled Glass Doors

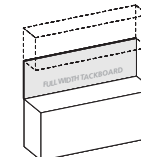

Page 35
Wall Hung Tackboards

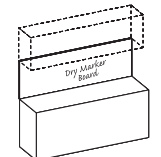

Page 36
Wall Hung Dry Marker Boards

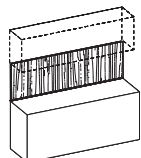

Page 37
Wall Hung Veneer Panels

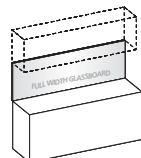

Page 38
Wall Hung Glassboards

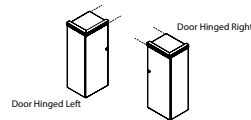

Page 39
Ganging - Overhead Tower -
Panel Doors
Wardrobe / Storage

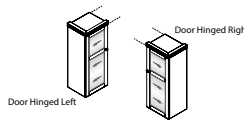

Page 40
Overhead Tower
Ganging Wardrobe / Leaded/Be-
veled Glass Doors

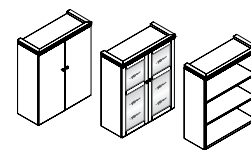

Page 41
Overhead Bookcase Hutches
Bookcase/Hutch Overhead

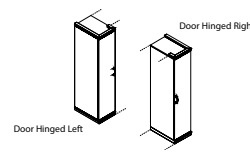

Page 42
Half Towers
Ganging Vertical Wardrobe Panel
Door

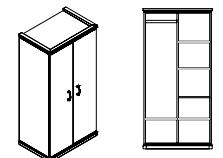

Page 43
Vertical Full Tower
Freestanding Panel Door - Ward-
robe / Storage

Statement of Line

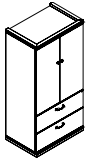

Page 44
Vertical Full Tower
Freestanding File / Wardrobe
- Panel Door

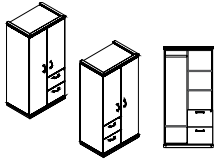

Page 45
Vertical Full Tower Wardrobe /
File / Storage
Freestanding Panel Door

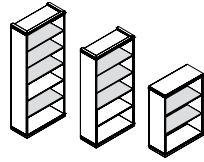

Page 46
Bookcases
Freestanding Open Bookcases

DARRAN

Veneer

DARRAN only uses HPVA AA Grade Flat Cut Cherry and Walnut Veneers. All veneers are selected and matched for balance and consistency.

Veneer Tops

Prado veneer tops feature a 45-pound density substrate with balanced 3-ply construction. Tops are 1-1/8" thick on MDF core comprised of 100% recycled and recovered wood fibers. All veneer tops are slipmatched and feature a 3mm external solid hardwood band or profile edge.

Laminate Tops

Prado high-pressure laminate tops feature a 45-pound density substrate with balanced 3-ply construction. Tops are 1-1/8" thick on MDF core comprised of 100% recycled and recovered wood fibers. All high pressure laminate tops are available with a profile edge, laminate self-edge or 2mm PVC edge band. Laminates in wood grain patterns feature a fine grain texture that features the polish and luxe of a real wood veneer with a subtle narrow grain structure.

Cleaning wood & laminate

In addition to regular dusting, give your furniture an occasional cleaning in accordance with our cleaning instructions. DARRAN wood and laminate products can be cleaned with a soft cloth and a mild soap and water mixture. Use approximately 32 oz of water mixed with one tablespoon of dish soap, always wiping with the grain. Dry with a soft cloth, going with the grain, to avoid spotting or streaking.

Wood products should be waxed periodically using a non-wax liquid; please do not use any waxy polish or cleaner. Interior of drawers may also be cleaned with mild soap and water mixture, or any household cleaner that is not petroleum or thinner-based.

Chassis & pedestal

Chassis components are 3/4" thick core of particle board or MDF rated EPP/SCS/CARB-II material with 3-ply balanced construction. Pedestal and Cabinets feature dowel construction reinforced with steel bracket plates, wood cleats, screws and glue. All units are standard with 1" adjustable glides that allow for leveling of units that are secured in solid wood glide blocks to prevent tear out.

Overhead cabinet construction Freestanding & wall mount

Freestanding Overhead storage cabinets are constructed of 1" and 3/4" thick core of particle board or MDF rated EPP/SCS/CARB-II material with 3-ply balanced construction. Panels are attached with cam fasteners in conjunction with dowels securely adhered with glue. All surface mount cabinets connect to work surface with anti-slip tape. Wall mount cabinets are mounted to the wall with steel "z" bracket attachment method using 5mm euro screws to attach to the back

Prado Features & Advantages

of the cabinet. All units ship with a steel "z" bracket. This bracket is mounted to the wall by field installers. Installers are responsible for selecting and supplying appropriate fasteners for wall conditions.

Bookcase construction

All chassis (sides, back, top and bottom panels) are constructed with 3/4" thick core of particle board or MDF rated EPP/SCS/CARB-II material with 3-ply balanced construction. Panels are attached with cam-lock fasteners in conjunction with dowels securely adhered with glue. Shelves on all units are 3/4" thick balance 3 ply panels. Optional heavy duty shelves are 1" thick lumber core balanced 5 ply construction.

Tackboards

Wall mount tackboards are constructed of .75" thick fiberboard. The fabric is precisely aligned and fitted to the tackboard with a sock on cover. Overhead storage tackboards are constructed of .75" thick fiberboard. The fabric is precisely aligned and fitted to the tackboard and adhered to the rigid hardboard with staples. Wall mount cabinets are mounted to the wall with steel "z" bracket attachment method using 5mm euro screws to attach to the back of the cabinet. All units ship with a steel "z" bracket. This bracket is mounted to the wall by field installers. Installers are responsible for selecting and supplying appropriate fasteners for wall conditions.

Adjustable glides

Glides provide 1" of vertical leveling adjustment. Glide bottom is durable metal. Glides are secured in solid wood blocks that are screwed and glued for durability.

Drawers

All drawers are constructed of four sides and a bottom, which are attached to a drawer front with screws for easy removal. Drawer fronts are vertically matched in balanced sets. Pencil trays are standard in all box drawers. Drawers are constructed of maple veneer 1/2" thick material for drawer sides, fronts and backs with a UV finish for maximum durability. Drawer bottoms are 3/16" thick 3-ply maple veneer. Drawer boxes are assembled at each corner with dowel joinery for maximum drawer strength. Lifetime free replacement warranty.

Drawer Fronts

Drawer fronts are vertically matched in balanced sets. Doors feature vertical veneer bookmatched horizontally in sets of 2 / 4 and 6 doors. All tower fronts matched in vertical sets.

Standard Wood Drawers

Optional hardwood veneer plywood drawers feature banded top and bottom edges for smoothness. Drawers are dowel joint construction with a UV cured finish over maple veneers, plus a lifetime free replacement guarantee.

Suspensions

All caseloads utilize cold rolled steel zinc plated high-grade drawer suspensions. Box and File drawers are full extension, featuring steel ball bearings for a smoother quieter range of motion

DARRAN

with soft close operation and are rated 100lbs. Lateral file drawers are a progressive action full extension suspension with the soft close operation and is rated at 150lbs. Lateral files include anti tip mechanism that will allow only one drawer at a time to be opened. All suspensions are soft close and are warranted for the lifetime of the product.

Hinges

Units with doors include 95 degree swing hinges.

Filing

Prado features metal file frames around the perimeter of the drawers with cross bars secured to the drawer sides to support hanging files. A metal adjustable cross bar is standard with all file drawers to support letter/legal filing front to back or side to side. File drawers have one adjustable cross bar and lateral files have two adjustable cross bars. See filing reference for details.

Locks

Locks are Standard on all drawers below the worksurface. Random lock cores are installed at the factory. Some units may be shipped with the same key number. Locks are Silver, Black or Bronze and match pull finish unless otherwise specified.

DARRAN will also send lock cores separately to the dealer at your request. These units will be send with an empty lock core and the Dealer will receive a shipment of the requested lock core/keys.

Keying

Keying is available either factory or field installed. Factory installed keying is random.

Wire management

Wire management capabilities include standard and optional worksurface grommets. Specify W-1 under surface wire channels for organization and management of all communication wires and cords. Horizontal J-Channel wire management (Sku: W-1) is sold separately to conceal wire under worksurfaces.

Grommets

Metal grommets are provided to match the drawer pull selection. Grommet is available in black, silver, white or antique brass. Specify standard or non-standard location. Black plastic grommets are available as an option for vertical applications.

Powerports

A large selection of power pods are available and handle power, data, docking stations and communication. See options section for selection..

Prado Features & Advantages

LED tasklights

LED task lighting provides high efficiency, low energy lighting with a long life. Surface mounted light is encased in silver aluminum channel with milk lense and rounded end caps. Lights are field installed.

Product specifications listed below:

- Diffuser creates a softer light and eliminates hot spots
- Touch dimmer switch
- Can be “daisy chained” up to 90W
- 4.6 watts per foot
- 120 LEDs per meter
- Certification: UL Listed
- 50,000 hour life span.

Color Temp is 4000K

WOOD FINISHES



WGW Gunstock Walnut



WHC Honey Cherry



WAC Amber Cherry



WNW Natural Walnut



WSW Smokey Walnut



WBW Henna Walnut



WEW Executive Walnut



WIC Crimson Cherry



WOC KoKo Cherry

HIGH PRESSURE LAMINATES



GHC Honey Cherry



GAC Amber Cherry



GNW Natural Walnut



GEW Executive Walnut



GIC Crimson Cherry



GOC KoKo Cherry



Finish

Welltech Finish delivers a superior furniture coating with exceptional performance that can withstand stringent cleaning agents and possesses unparalleled durability, allowing DARRAN to provide lasting, sustainable products to our customers.

DARRAN

Standard profile

Prado Edge
Hardwood Rim Species Same As Surface Veneer

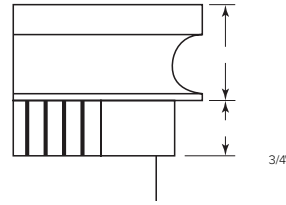

Tops:
1-1/8" thick with 3/4" thick Solid Hardwood Rim profile shaped on 4 sides of desk and 3 sides of credenzas.

Moldings:
3/4" Dentil Moldings and corners are handfitte under top edge profile. (DSM1: Delete moldings - n/c)

Solid Hardwood Base:
Bases are constructed of solid hardwood lumber 2-1/2" x 1-5/8". 1-1/2" x 1-1/2" hardwood corner block with inserted leveler. All units are standard with a 1" adjustable glide.

Cornice Top Profile

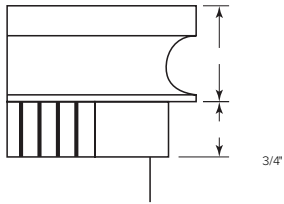

Base profile

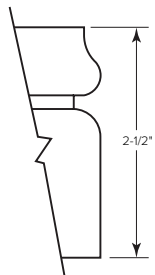

Solid Hardwood Base:
Bases are constructed of solid hardwood lumber 2-1/2" x 1-5/8". 1-1/2" x 1-1/2" hardwood corner block with inserted leveler. All units are standard with a 1" adjustable glide.

Hookup edge profile

Coped Edge

Prado Edges | Pulls | Knobs

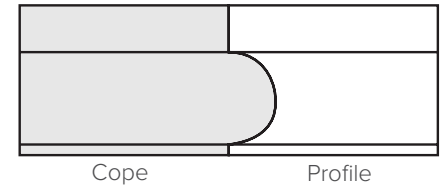

Pulls/knobs

Factory Installed

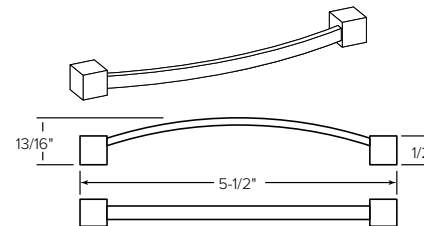

PL-125 Antique Pewter
PL-126 Antique English
PL-127 Matte Black

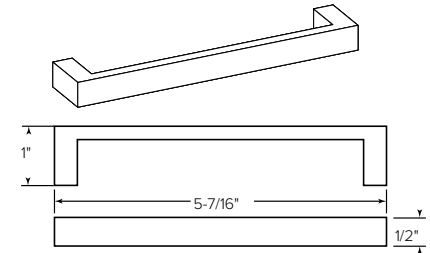

PL-115 Matte Black
PL-116 Matte Nickel

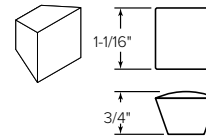

DK-125 Antique Pewter
DK-126 Antique English
DK-127 Matte Black

TM30
Black
1-5/8" Dia.

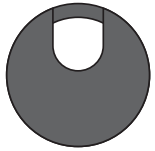

TM31
Silver
1-5/8" Dia.

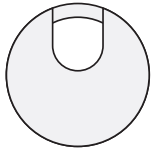

TM33
Antique Brass
1-5/8" Dia.

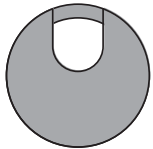

Optional grommets

Factory Installed

Grommets (Standard Location)

Specify Color and Left/Right/Center - \$50 ea.

- Black: TM30-R (Right), TM30-L (Left), TM30-C (Center)
- Silver: TM31-R (Right), TM31-L (Left), TM31-C (Center)
- Antique Brass: TM33-R (Right), TM33-L (Left), TM33-C (Center)

Grommets (Non-Standard Location)

Provide drawing w/ Grommet Location and Specify Color - \$95 ea.

- Black: TM30-NS
- Silver: TM31-NS
- Antique Brass: TM33-NS

Prado Grommets | Grommet Reference

TM50
Black
1-5/8" Dia.



Grommets (vertical surface)

Standard Location - \$50 ea.

- Black Plastic Vertical Surface: TM50-C (Bottom Center)

Non-Standard Location - \$95 ea.

- Black Plastic Vertical Surface: TM50-NS

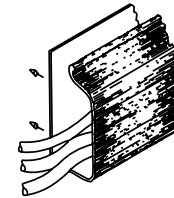

W1

Horizontal J-channel

Horizontal J-Channel wire management (Sku: W-1) is sold separately to conceal wire under worksurfaces.

Standard grommet location reference

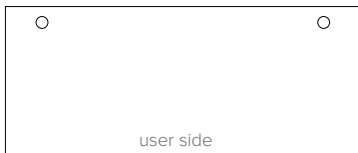

Desk
Specify Right or Left Grommet



6" Overhang Desk
Specify Right or Left Grommet

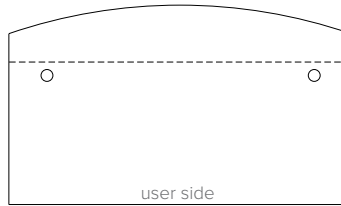

6"/12" Bow Front Desk
Specify Right or Left Grommet

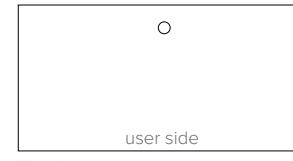

Bridge
Center Grommet

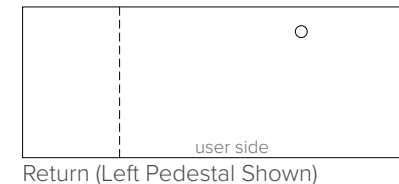

Return (Left Pedestal Shown)
Right Pedestal - Left Grommet
Left Pedestal - Right Grommet

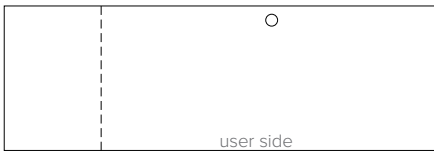

Workstation Credenza
Center Kneespace Grommet

Ganging – Flush Cut Modification

30”H Casework Worksurface & Base Ganging Modifications

To gang two casework units, each unit end to be ganged must be flush cut modified for gapless surfaces and cabinet chassis.

Order Option:

- FC-B: Flush Unit Both Sides(Facing) for Ganging - \$100
- FC-L: Flush Unit Left (Facing) for Ganging - \$100
- FC-R: Flush Unit Right (Facing) for Ganging - \$100

Flush cut modification per unit includes all modifications to gang to one end or both ends when units are ganged. Modification includes tops, base and molding.

Modification reduces width size approximately 1” per end.

Overhead consoles and towers are offered freestanding and ganging – inclusive of flush cut modifications.

Example:

PRA3024CA104W Two Drawer Lateral File (Left) Flush Cut Right – FC-R...\$100

PRA7124CA054W Kneespace Credenza (Right) Flush Cut Left – FC-L...\$100

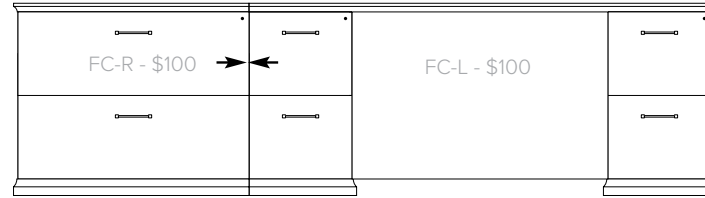

Height reference

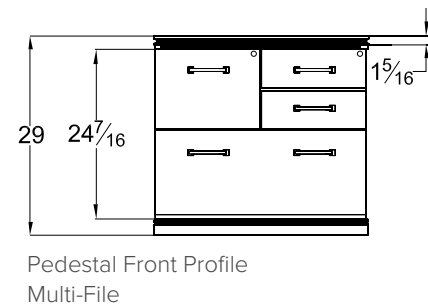
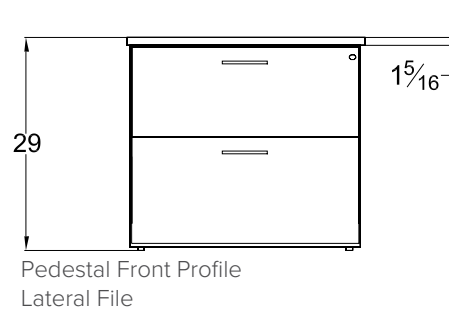
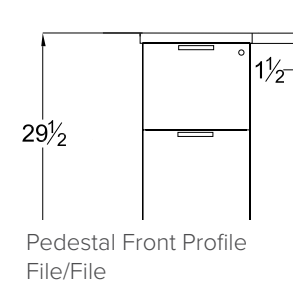
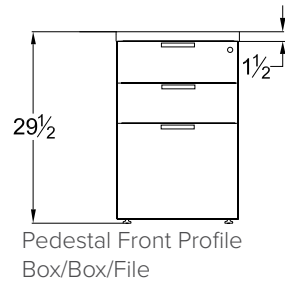
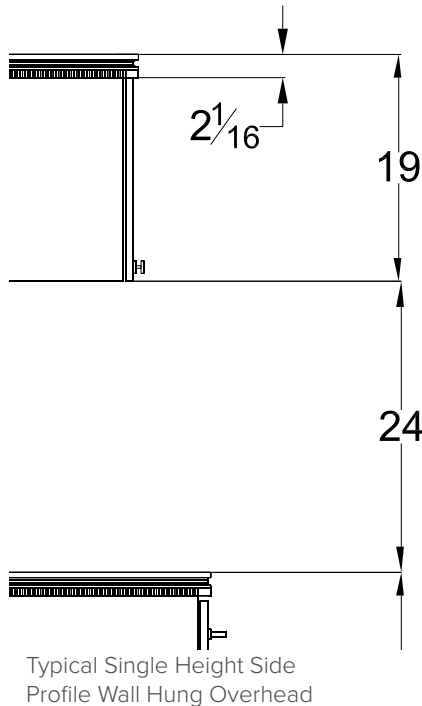

Modesty reference

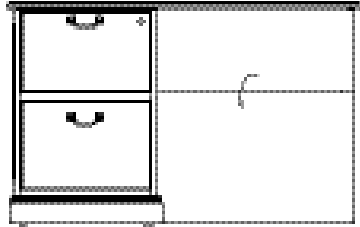

Top View

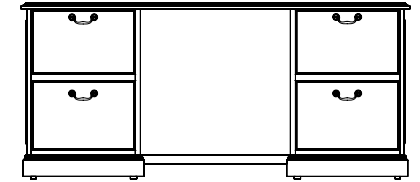
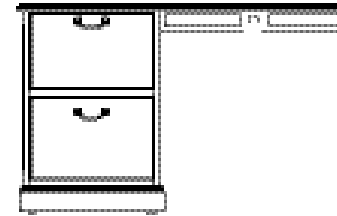

M34

Drop Door Tech Modesty

M51

Open Back Modesty with 4" Wire Management Rail

M37

Fixed Full Modesty

Overhead door

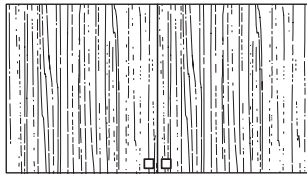

Panel Door

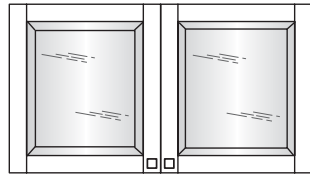

Beveled Glass Door

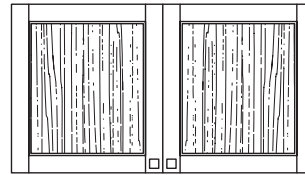

Solid Hardwood Frame Door w/ Veneer Insert - Only Available on "W" Styles

Grain direction

Veneer chassis parts are vertical grain. Doors feature vertical veneer bookmatched horizontally in sets of 2,4, and 6 doors. Tower fronts are matched in vertical sets.



Desk

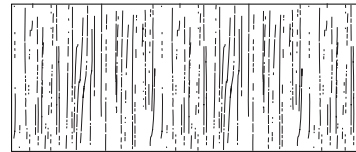

Runoff Desk
Grain Direction on TFL Units Above 66" runs end to end

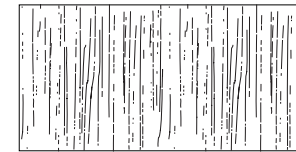

Bridge
Grain Direction on TFL Units Above 66" runs end to end

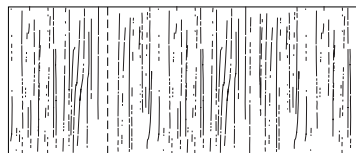

Return
Grain Direction on TFL Units Above 66" runs end to end



Credenza

Interior drawer dimensions

UNIT DEPTH	DRAWER TYPE	OVERALL DIMENSIONS			INTERIOR DRAWER DIMENSIONS			NOTES
		W	D	H	W	D	H	
15-5/8" Letter	30" Box	13-1/8	19-11/16	4	12-1/8	18-11/16	3-7/16	Units less than 72"
	30" File	13-1/8	19-11/16	9-13/16	12-1/8	18-11/16	9-5/16	Units less than 72"
	24" Box	13-1/8	16-1/16	4	12-1/8	15-1/16	3-7/16	Units less than 72"
	24" File	13-1/8	16-1/16	9-13/16	12-1/8	15-1/16	9-5/16	Units less than 72"
18-9/16" Legal	36" Box	16-1/6	19-11/16	4	12-1/8	18-11/16	3-7/16	Units 72" & above
	36" File	16-1/6	19-11/16	9-13/16	12-1/8	18-11/16	9-5/16	Units 72" & above
	30" Box	16-1/6	19-11/16	4	12-1/8	18-11/16	3-7/16	Units 72" & above
	30" File	16-1/6	19-11/16	9-13/16	12-1/8	18-11/16	9-5/16	Units 72" & above
	24" Box	16-1/6	16-1/16	4	12-1/8	15-1/16	3-7/16	Units less than 72"
	24" File	16-1/6	16-1/16	9-13/16	12-1/8	15-1/16	9-5/16	Units less than 72"
29" Lateral	24" File	26-1/2	16-1/16	9-13/16	25-1/2	15-1/16	9-5/16	Workstation Credenzas less than 82"
31" Lateral	24" File	28-9/16	16-1/16	9-13/16	27-9/16	15-1/16	9-5/16	Multi-File Lateral File
35" Lateral	24" File	32-1/2	16-1/16	9-13/16	31-1/2	15-1/16	9-5/16	Workstation Credenzas over 83"

Filing reference

Filing for 24" depth units

13 1/8" Wide File Drawer - 16 1/16" Deep

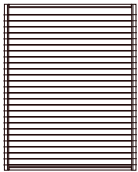

Letter Front to Back

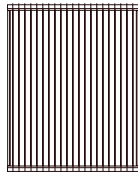

Legal Side to Side with File Rail

29" Lateral file drawer

26-1/2" Wide File Drawer - 16-1/16" Deep

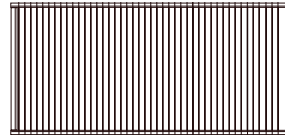

Legal Side to Side

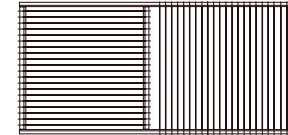

Legal Side to Side
Letter Front to Back with File Rail

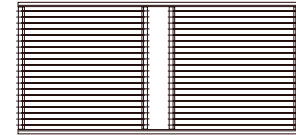

Letter Front to Back with File Rail

Filing for 30" & 36" depth units

13 1/8" Wide File Drawer - 19 11/16" Deep

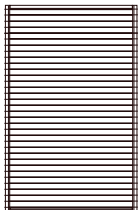

Letter Front to Back



Legal Side to Side with File Rail

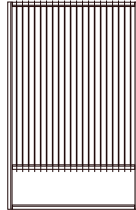

Letter Side to Side with File Rail

35" Lateral file drawer

32-1/2" Wide File Drawer - 16-1/16" Deep

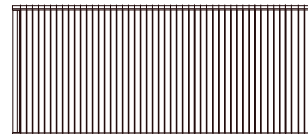

Legal Side to Side

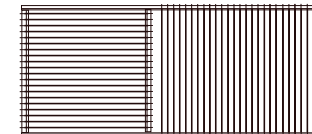

Legal Side to Side
Letter Front to Back with File Rail

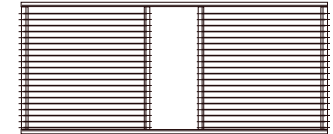

Letter Front to Back with File Rail

Prado

Desk
Breakfront - Double Pedestal

[Click here to view statement of line](#)

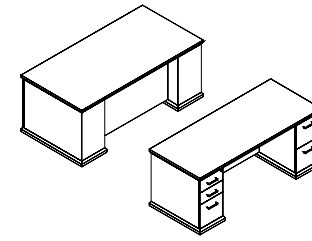

1 Select Model

w" x d" x h"
Legal Width Double Letter Filing

84 x 36 x 29 395 PRA8436DD000W 7145
72 x 36 x 29 375 PRA7236DD000W 6477

Letter Width Legal / Letter Filing

72 x 30 x 29 350 PRA7230DD000W 6312
66 x 30 x 29 320 PRA6630DD000W 6141

Weight

Standard Veneer Top Standard Veneer Chassis	Premium Veneer Top Premium Veneer Chassis	High Pressure Laminate Top Veneer Chassis	Thermally Fused Laminate Top Thermally Fused Laminate Chassis
--	--	--	--

"P" Option N/A
"P" Option N/A

PRA8436DD000G 7145
PRA7236DD000G 6477

"M" Option N/A
"M" Option N/A

"P" Option N/A
"P" Option N/A

PRA7230DD000G 6312
PRA6630DD000G 6141

"M" Option N/A
"M" Option N/A

2 Select Finish

[Click to view finishes](#)

3 Select Edge

[Click to view edges](#)



Prado



Prado

4 Select Hardware

[Click to view details](#)



PL-115 Matte Black
PL-116 Matte Nickel

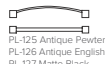

PL-125 Antique Pewter
PL-126 Antique English
PL-127 Matte Black



PL-115 Matte Black
PL-116 Matte Nickel



PL-125 Antique Pewter
PL-126 Antique English
PL-127 Matte Black

Product Features

- Adjustable glides
- Full extension drawers - locking
- Soft close suspension drawer(s)
- Solid hardwood base/dentil molding

Notes

- Glides adjust 1"

Options

Accessories

- K1: Center Drawer - \$290
- K4: Box Drawer Black Dura-Leather Bottom - \$495
- K28: Articulating keyboard w/ mouse pad (Installed) - \$390
- P1-A: Pullout writing shelf - \$205
- PC10A: desk Pedestal Wire Cavity - \$100

Drawer

- P6: Modify File/File to Box/Box/File - \$55

Grommets (Standard Location)

- Specify Color and Location Right/Left - \$50 ea.
- Black: TM30-R (Right), TM30-L (Left)
- Silver: TM31-R (Right), TM31-L (Left)
- Antique Brass: TM33-R (Right), TM33-L (Left)

Grommets (Non-Standard Location)

- Provide drawing w/ Grommet Location and Specify Color - \$95 ea.
- Black: TM30-NS
- Silver: TM31-NS
- Antique Brass: TM33-NS

Molding

- DSM1: Delete Dentil Molding Only - n/c

Prado

Desk
Bowfront / Breakfront Double Pedestal

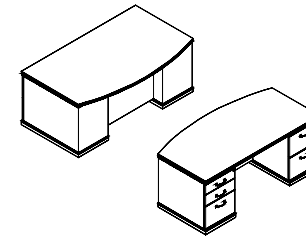

[Click here to view statement of line](#)

1 Select Model

w" x d" x h"
Legal Width Double Letter Filing

84 x 36/42 x 29 420 PRA8442DD006W 8149
72 x 36/42 x 29 390 PRA7242DD006W 7482

Letter Width Legal / Letter Filing

72 x 30/36 x 29 345 PRA7236DD006W 7313

Weight

Standard Veneer Top Standard Veneer Chassis	Premium Veneer Top Premium Veneer Chassis	High Pressure Laminate Top Veneer Chassis	Thermally Fused Laminate Top Thermally Fused Laminate Chassis
--	--	--	--

"P" Option N/A
"P" Option N/A

PRA8442DD006G 8149
PRA7242DD006G 7482

"M" Option N/A
"M" Option N/A

"P" Option N/A

PRA7236DD006G 7313

"M" Option N/A

2 Select Finish

[Click to view finishes](#)

3 Select Edge

[Click to view edges](#)



Prado



Prado

4 Select Hardware

[Click to view details](#)



PL-115 Matte Black
PL-116 Matte Nickel

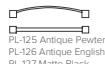

PL-125 Antique Pewter
PL-126 Antique English
PL-127 Matte Black



PL-115 Matte Black
PL-116 Matte Nickel



PL-125 Antique Pewter
PL-126 Antique English
PL-127 Matte Black

Product Features

- Adjustable glides
- Full extension drawers - locking
- Soft close suspension drawer(s)
- Solid hardwood base/dentil molding

Notes

- Glides adjust 1"

Options

Accessories

- K1: Center Drawer - \$290
- K28: Articulating keyboard w/ mouse pad (installed) - \$390
- P1-A: Pullout writing shelf - \$205
- PC10A: desk Pedestal Wire Cavity - \$100

Drawer

- P6: Modify File/File to Box/Box/File - \$55

Grommets (Standard Location)

Specify Color and Location Right/Left - \$50 ea.

- Black: TM30-R (Right), TM30-L (Left)
- Silver: TM31-R (Right), TM31-L (Left)
- Antique Brass: TM33-R (Right), TM33-L (Left)

Grommets (Non-Standard Location)

Provide drawing w/ Grommet Location and Specify Color - \$95 ea.

- Black: TM30-NS
- Silver: TM31-NS
- Antique Brass: TM33-NS

Molding

- DSM1: Delete Dentil Molding Only - n/c

Prado

Table Desks
Fluted Leg Table Desk

[Click here to view statement of line](#)

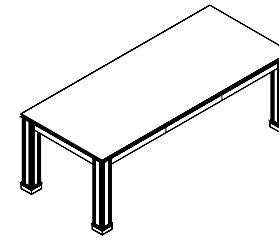

1 Select Model

w" x d" x h"	Weight
84 x 36 x 29	250
72 x 36 x 29	235

Standard Veneer Top Standard Veneer Chassis		Premium Veneer Top Premium Veneer Chassis	High Pressure Laminate Top Veneer Chassis	Thermally Fused Laminate Top Thermally Fused Laminate Chassis
PRA8436DT107W	7145	"P" Option N/A	PRA8436DT107G	7145
PRA7236DT107W	6477	"P" Option N/A	PRA7236DT107G	6477
				"M" Option N/A "M" Option N/A

Product Features

- Adjustable glides
- Dentil molding
- Full extension drawers - locking
- Post leg 4" x 4" w/ flute detailing
- Solid hardwood base/dentil molding
- Utility center drawer w/ black Dura-Leather bottom

Notes

- Glides adjust 1"

Options

Grommets (Standard Location)

Specify Color and Location Right/Left - \$50 ea.

- Black: TM30-R (Right), TM30-L (Left)
- Silver: TM31-R (Right), TM31-L (Left)
- Antique Brass: TM33-R (Right), TM33-L (Left)

Grommets (Non-Standard Location)

Provide drawing w/ Grommet Location and Specify Color - \$95 ea.

- Black: TM30-NS
- Silver: TM31-NS
- Antique Brass: TM33-NS

2 Select Finish

[Click to view finishes](#)

3 Select Edge

[Click to view edges](#)



4 Select Hardware

[Click to view details](#)

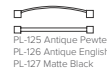
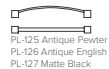

Prado

Workstation Desks
Breakfront - Single Pedestal

[Click here to view statement of line](#)

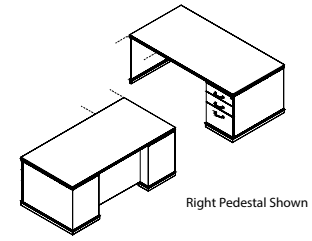

1 Select Model

w" x d" x h"

Weight

Legal/dbl Letter Filing (Right Pedestal)

72 x 36 x 29 300 PRA7236DS010W 5458
Legal/dbl Letter Filing (Left Pedestal)

72 x 36 x 29 300 PRA7236DS009W 5458
legal/letter filing (Right Pedestal)

72 x 30 x 29 275 PRA7230DS010W 5292
66 x 30 x 29 250 PRA6630DS010W 5124
legal/letter filing (Left Pedestal)

72 x 30 x 29 275 PRA7230DS009W 5292
66 x 30 x 29 250 PRA6630DS009W 5124

Standard Veneer Top
Standard Veneer Chassis

Premium Veneer Top
Premium Veneer Chassis

High Pressure Laminate Top
Veneer Chassis

Thermally Fused Laminate Top

"P" Option N/A

PRA7236DS010G 5458

"M" Option N/A

"P" Option N/A

PRA7236DS009G 5458

"M" Option N/A

"P" Option N/A

PRA7230DS010G 5292

"M" Option N/A

"P" Option N/A

PRA6630DS010G 5124

"M" Option N/A

"P" Option N/A

PRA7230DS009G 5292

"M" Option N/A

"P" Option N/A

PRA6630DS009G 5124

"M" Option N/A

Product Features

- Adjustable glides
- Breakfront modesty
- Full extension drawers - locking
- Hookup hardware
- Soft close suspension drawer(s)
- Solid hardwood base/dentil molding

Notes

- Glides adjust 1"

Options

Accessories

- K1: Center Drawer - \$290
- K28: Articulating keyboard w/ mouse pad (installed) - \$390
- P1-A: Pullout writing shelf - \$205
- PC10A: desk Pedestal Wire Cavity - \$100

Drawer

- P6: Modify Box/Box/File to File/File - \$55

Grommets (Standard Location)

Specify Color and Location Right/Left - \$50 ea.

- Black: TM30-R (Right), TM30-L (Left)
- Silver: TM31-R (Right), TM31-L (Left)
- Antique Brass: TM33-R (Right), TM33-L (Left)

Grommets (Non-Standard Location)

Provide drawing w/ Grommet Location and Specify Color - \$95 ea.

- Black: TM30-NS
- Silver: TM31-NS
- Antique Brass: TM33-NS

Molding

- DSM1: Delete Dentil Molding Only - n/c

2 Select Finish

[Click to view finishes](#)

3 Select Edge

[Click to view edges](#)



Prado



Prado

4 Select Hardware

[Click to view details](#)



PL-115 Matte Black
PL-116 Matte Nickel

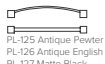

PL-125 Antique Pewter
PL-126 Antique English
PL-127 Matte Black



PL-115 Matte Black
PL-116 Matte Nickel



PL-125 Antique Pewter
PL-126 Antique English
PL-127 Matte Black

Prado

Workstation Desks
Bowfront / Breakfront Single Pedestal

[Click here to view statement of line](#)

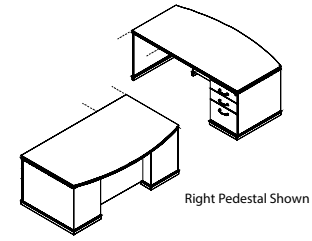

1 Select Model

w" x d" x h"

Weight

Legal/dbl Letter Filing (Right Pedestal)

72 x 36/42 x 29 320 PRA7242DS018W 6293
Legal/dbl Letter Filing (Left Pedestal)

72 x 36/42 x 29 320 PRA7242DS017W 6293
legal/letter filing (Right Pedestal)

72 x 30/36 x 29 295 PRA7236DS018W 6128
legal/letter filing (Left Pedestal)

72 x 30/36 x 29 295 PRA7236DS017W 6128

Standard Veneer Top Standard Veneer Chassis	Premium Veneer Top Premium Veneer Chassis	High Pressure Laminate Top Veneer Chassis	Thermally Fused Laminate Top Thermally Fused Laminate Chassis
--	--	--	--

"P" Option N/A

PRA7242DS018G 6293

"M" Option N/A

"P" Option N/A

PRA7242DS017G 6293

"M" Option N/A

"P" Option N/A

PRA7236DS018G 6128

"M" Option N/A

"P" Option N/A

PRA7236DS017G 6128

"M" Option N/A

Product Features

- Adjustable glides
- Breakfront modesty
- Full extension drawers - locking
- Hookup hardware
- Soft close suspension drawer(s)
- Solid hardwood base/dentil molding

Notes

- Glides adjust 1"

Options

Accessories

- K1: Center Drawer - \$290
- K28: Articulating keyboard w/ mouse pad (installed) - \$390
- P1-A: Pullout writing shelf - \$205
- PC10A: desk Pedestal Wire Cavity - \$100

Drawer

- P6: Modify Box/Box/File to File/File - \$55

Grommets (Standard Location)

Specify Color and Location Right/Left - \$50 ea.

- Black: TM30-R (Right), TM30-L (Left)
- Silver: TM31-R (Right), TM31-L (Left)
- Antique Brass: TM33-R (Right), TM33-L (Left)

Grommets (Non-Standard Location)

Provide drawing w/ Grommet Location and Specify Color - \$95 ea.

- Black: TM30-NS
- Silver: TM31-NS
- Antique Brass: TM33-NS

Molding

- DSM1: Delete Dentil Molding Only - n/c

2 Select Finish

[Click to view finishes](#)

3 Select Edge

[Click to view edges](#)



Prado



Prado

4 Select Hardware

[Click to view details](#)



PL-115 Matte Black
PL-116 Matte Nickel

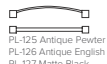

PL-125 Antique Pewter
PL-126 Antique English
PL-127 Matte Black



PL-115 Matte Black
PL-116 Matte Nickel



PL-125 Antique Pewter
PL-126 Antique English
PL-127 Matte Black

Prado

Workstation "L" Returns
File / File

[Click here to view statement of line](#)

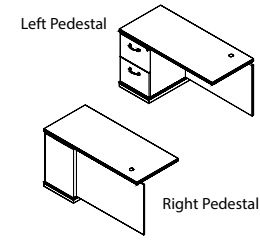

1 Select Model

w" x d" x h"

	Weight								
Left Pedestal									
60 x 24 x 29	165	PRA6024RE195W	3971	"P" Option N/A	PRA6024RE195G	3971	"M" Option N/A		
54 x 24 x 29	155	PRA5424RE195W	3885	"P" Option N/A	PRA5424RE195G	3885	"M" Option N/A		
48 x 24 x 29	145	PRA4824RE195W	3802	"P" Option N/A	PRA4824RE195G	3802	"M" Option N/A		
42 x 24 x 29	135	PRA4224RE195W	3717	"P" Option N/A	PRA4224RE195G	3717	"M" Option N/A		
Right Pedestal									
60 x 24 x 29	165	PRA6024RE196W	3971	"P" Option N/A	PRA6024RE196G	3971	"M" Option N/A		
54 x 24 x 29	155	PRA5424RE196W	3885	"P" Option N/A	PRA5424RE196G	3885	"M" Option N/A		
48 x 24 x 29	145	PRA4824RE196W	3802	"P" Option N/A	PRA4824RE196G	3802	"M" Option N/A		
42 x 24 x 29	135	PRA4224RE196W	3717	"P" Option N/A	PRA4224RE196G	3717	"M" Option N/A		

2 Select Finish

[Click to view finishes](#)

3 Select Edge

[Click to view edges](#)



4 Select Hardware

[Click to view details](#)

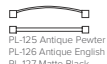

Product Features

- 1 Standard grommet - matches pull finish or specify black TM30, silver TM31 or antique brass TM33
- Finished back - open plan
- Full extension drawers - locking
- Full fixed modesty
- Soft close suspension drawer(s)
- Solid hardwood base/dentil molding

Notes

- Return Top Grain Direction Same As Desk 42" -60"W

Options

Accessories

- K1: Center Drawer - \$290
- K28: Articulating keyboard w/ mouse pad (Installed) - \$390

Drawer

- P6: Modify File/File to Box/Box/File - \$55 per pedestal
- P40B: extra Box/Box/File or File/File to Kneespace - \$1025

Flush Cut

- FC-R: Flush Unit Right(Facing) for Ganging - \$100
- FC-L: Flush Unit Left (Facing) for Ganging - \$100

Grommets (Non-Standard Location)

Provide drawing w/ Grommet Location and Specify Color - \$95 ea.

- Black: TM30-NS
- Silver: TM31-NS
- Antique Brass: TM33-NS

Modesty

- M34T: Drop Door Tech Modesty - \$130
- M5t: Open Back Modesty with Wire Mgmt Rail - Deduct \$95

Molding

- DSM1: Delete Dentil Molding Only - n/c

Prado

Workstation "L" Returns
Lateral File

[Click here to view statement of line](#)

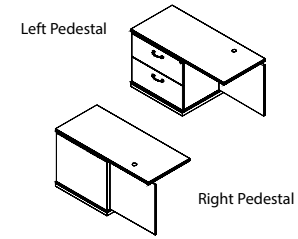

1 Select Model

w" x d" x h"

	Weight	Standard Veneer Top Standard Veneer Chassis	Premium Veneer Top Premium Veneer Chassis	High Pressure Laminate Top Veneer Chassis	Thermally Fused Laminate Top Thermally Fused Laminate Chassis
Left Pedestal					
60 x 24 x 29	200	PRA6024RE187W 4470	"P" Option N/A	PRA6024RE187G 4470	"M" Option N/A
54 x 24 x 29	185	PRA5424RE187W 4219	"P" Option N/A	PRA5424RE187G 4219	"M" Option N/A
48 x 24 x 29	175	PRA4824RE187W 4136	"P" Option N/A	PRA4824RE187G 4136	"M" Option N/A
Right Pedestal					
60 x 24 x 29	200	PRA6024RE188W 4470	"P" Option N/A	PRA6024RE188G 4470	"M" Option N/A
54 x 24 x 29	185	PRA5424RE188W 4219	"P" Option N/A	PRA5424RE188G 4219	"M" Option N/A
48 x 24 x 29	175	PRA4824RE188W 4136	"P" Option N/A	PRA4824RE188G 4136	"M" Option N/A

2 Select Finish

[Click to view finishes](#)

3 Select Edge

[Click to view edges](#)



Prado



Prado

4 Select Hardware

[Click to view details](#)



PL-115 Matte Black
PL-116 Matte Nickel

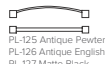

PL-125 Antique Pewter
PL-126 Antique English
PL-127 Matte Black



PL-115 Matte Black
PL-116 Matte Nickel



PL-125 Antique Pewter
PL-126 Antique English
PL-127 Matte Black

Product Features

- 1 Standard grommet - matches pull finish or specify black TM30, silver TM31 or antique brass TM33
- Finished back - open plan
- Full fixed modesty
- Features ball bearing suspensions, suspensions are full extension
- Solid hardwood base/dentil molding

Notes

- Keyboards N/A on 48" Lateral File Returns
- Return Top Grain Direction Same As Desk 42" -60" W

Options

Accessories

- K1: Center Drawer - \$290
- K28: Articulating keyboard w/ mouse pad (Installed) - \$390 (n/a on 48" W units)

Drawer

- P40B: extra Box/Box/File or File/File to Kneespace (n/a on 48") - \$1,025

Flush Cut

- FC-R: Flush Unit Right(Facing) for Ganging - \$100
- FC-L: Flush Unit Left (Facing) for Ganging - \$100

Grommets (Non-Standard Location)

Provide drawing w/ Grommet Location and Specify Color - \$95 ea.

- Black: TM30-NS
- Silver: TM31-NS
- Antique Brass: TM33-NS

Modesty

- M34T: Drop Door Tech Modesty - \$130
- M51: Open Back Modesty with Wire Mgmt Rail - Deduct \$95

Molding

- DSM1: Delete Dentil Molding Only - n/c

Prado

Workstation "L" Returns
Multi-File

[Click here to view statement of line](#)

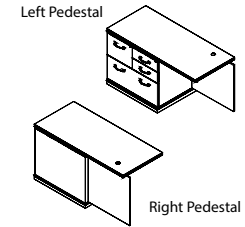

1 Select Model

w" x d" x h"	Weight
Left Pedestal	
60 x 24 x 29	200
54 x 24 x 29	185
48 x 24 x 29	175
Right Pedestal	
60 x 24 x 29	200
54 x 24 x 29	185
48 x 24 x 29	175

	Standard Veneer Top Standard Veneer Chassis	Premium Veneer Top Premium Veneer Chassis	High Pressure Laminate Top Veneer Chassis	Thermally Fused Laminate Top Thermally Fused Laminate Chassis
"P" Option N/A		"P" Option N/A		"M" Option N/A
PRA6024RE218W 4807	PRA6024RE218W 4807	PRA6024RE219W 4807	PRA6024RE218G 4807	PRA6024RE219G 4807
"P" Option N/A		"P" Option N/A		"M" Option N/A
PRA5424RE218W 4553	PRA5424RE218W 4553	PRA5424RE219W 4553	PRA5424RE218G 4553	PRA5424RE219G 4553
"P" Option N/A		"P" Option N/A		"M" Option N/A
PRA4824RE218W 4470	PRA4824RE218W 4470	PRA4824RE219W 4470	PRA4824RE218G 4470	PRA4824RE219G 4470

Product Features

- 1 Standard grommet - matches pull finish or specify black TM30, silver TM31 or antique brass TM33
- Full fixed modesty
- Multi-File is 31"W
- iWi & iGi Box and File Drawers feature soft close suspensions (Lateral Drawers feature ball bearing suspensions)
- Solid hardwood base/dentil molding

Notes

- Return Top Grain Direction Same As Desk 42" -60"W

Options

Accessories

- K1: Center Drawer - \$290
- K28: Articulating keyboard w/ mouse pad (Installed) - \$390 (n/a on 48" W units)

Drawer

- P40B: extra Box/Box/File or File/File to Kneespace (n/a on 48") - \$1,025

Flush Cut

- FC-R: Flush Unit Right(Facing) for Ganging - \$100
- FC-L: Flush Unit Left (Facing) for Ganging - \$100

Grommets (Non-Standard Location)

- Provide drawing w/ Grommet Location and Specify Color - \$95 ea.
- Black: TM30-NS
- Silver: TM31-NS
- Antique Brass: TM33-NS

Modesty

- M34T: Drop Door Tech Modesty - \$130
- M5t: Open Back Modesty with Wire Mgmt Rail - Deduct \$95

Molding

- DSM1: Delete Dentil Molding Only - n/c

2 Select Finish

[Click to view finishes](#)

3 Select Edge

[Click to view edges](#)



Prado



Prado

4 Select Hardware

[Click to view details](#)



PL-115 Matte Black
PL-116 Matte Nickel

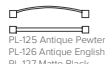

PL-125 Antique Pewter
PL-126 Antique English
PL-127 Matte Black



PL-115 Matte Black
PL-116 Matte Nickel



PL-125 Antique Pewter
PL-126 Antique English
PL-127 Matte Black

Prado

Workstation Bridges
 Bridge - Fixed Back

[Click here to view statement of line](#)

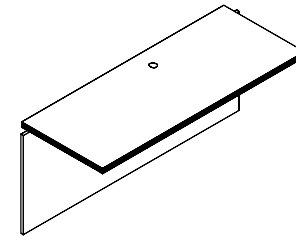

1 Select Model

w" x d" x h"

Weight	48 x 24 x 29	42 x 24 x 29	36 x 24 x 29
85			
80			
70			

Standard Veneer Top Standard Veneer Chassis		Premium Veneer Top Premium Veneer Chassis		High Pressure Laminate Top Veneer Chassis		Thermally Fused Laminate Top Thermally Fused Laminate Chassis	
PRA4824BR150W	1794	"P" Option N/A		PRA4824BR150G	1794	"M" Option N/A	
PRA4224BR150W	1711	"P" Option N/A		PRA4224BR150G	1711	"M" Option N/A	
PRA3624BR150W	1675	"P" Option N/A		PRA3624BR150G	1675	"M" Option N/A	

Product Features

- 1 Standard grommet - matches pull finish or specify black TM30, silver TM31 or antique brass TM33

Notes

- Bridge grain direction same as Desk / Credenza

Options

Accessories

- K28: Articulating keyboard w/ mouse pad (Installed) - \$390

Bridge

- M5t: Open back wall access bridge option - Deduct \$95

- M34T: Drop Door Tech Modesty - \$130

Grommets (Non-Standard Location)

Provide drawing w/ Grommet Location and Specify Color - \$95 ea.

- Black: TM30-NS

- Silver: TM31-NS

- Antique Brass: TM33-NS

Molding

- DSM1: Delete Dentil Molding Only - n/c

2 Select Finish

[Click to view finishes](#)

3 Select Edge

[Click to view edges](#)



Prado



Prado

4 Select Hardware

[Click to view details](#)

Hardware
N/A

Hardware
N/A

Prado

Credenzas
File / Storage

[Click here to view statement of line](#)

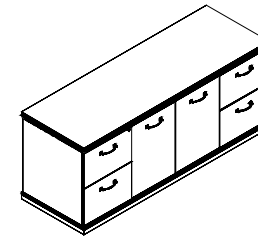

1 Select Model

w" x d" x h"
71 x 24 x 29 300
65 x 24 x 29 290

Weight

Standard Veneer Top Standard Veneer Chassis	Premium Veneer Top Premium Veneer Chassis	High Pressure Laminate Top Veneer Chassis	Thermally Fused Laminate Top Thermally Fused Laminate Chassis
PRA7124CA050W 6128 PRA6524CA050W 5960	*P* Option N/A *P* Option N/A	PRA7124CA050G 6128 PRA6524CA050G 5960	*M* Option N/A *M* Option N/A

Product Features

- 1 Adjustable veneer shelf behind door set
- Adjustable glides
- Full extension drawers - locking
- Legal/Letter filing
- Soft close suspension drawer(s)
- Solid hardwood base/dentil molding

Notes

- Glides adjust 1"
- Unit has black back panel and is not designed for Open Plan use. Select OPB Option for Open Plan application

Options

Door

- D2: Door Lock - \$100 per door set
- D6: Delete Doors - n/c
- D9SC: Soft Close Door Hinges - \$20 per door

Flush Cut

- FC-B: Flush Unit Both Sides(Facing) for Ganging - \$100
- FC-R: Flush Unit Right(Facing) for Ganging - \$100
- FC-L: Flush Unit Left (Facing) for Ganging - \$100

Grommets (Vertical Surface)

- Standard Location - \$50 ea.
- Black Plastic Vertical Surface: TM50-C (Bottom Center)
- Non-Standard Location: Provide drawing w/ Grommet Location and Specify Color - \$95
- Black Plastic Vertical Surface: TM50-NS

Molding

- DSM1: Delete Dentil Molding Only - n/c

Open Plan _ Finished Back

- OPB: W "G" Style - Modify Unit for Open Plan Application - \$295

2 Select Finish

[Click to view finishes](#)

3 Select Edge

[Click to view edges](#)



Prado



Prado

4 Select Hardware

[Click to view details](#)



PL-115 Matte Black
PL-116 Matte Nickel

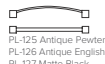

PL-125 Antique Pewter
PL-126 Antique English
PL-127 Matte Black



PL-115 Matte Black
PL-116 Matte Nickel



PL-125 Antique Pewter
PL-126 Antique English
PL-127 Matte Black

Prado

Credenzas
Kneespace

[Click here to view statement of line](#)

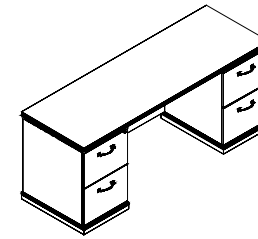

1 Select Model

w" x d" x h"	Weight
71 x 24 x 29	260
65 x 24 x 29	250

Standard Veneer Top Standard Veneer Chassis		Premium Veneer Top Premium Veneer Chassis	High Pressure Laminate Top Veneer Chassis	Thermally Fused Laminate Top Thermally Fused Laminate Chassis
PRA7124CA054W	5292	"P" Option N/A	PRA7124CA054G	5292
PRA6524CA054W	5124	"P" Option N/A	PRA6524CA054G	5124
			 Prado	
			 Prado	

2 Select Finish

[Click to view finishes](#)

3 Select Edge

[Click to view edges](#)



Prado

4 Select Hardware

[Click to view details](#)



PL-115 Matte Black
PL-116 Matte Nickel

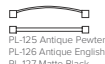

PL-125 Antique Pewter
PL-126 Antique English
PL-127 Matte Black



PL-115 Matte Black
PL-116 Matte Nickel



PL-125 Antique Pewter
PL-126 Antique English
PL-127 Matte Black

Product Features

- Adjustable glides
- Full extension drawers - locking
- Kneespace w/ fixed full modesty
- Legal/Letter filing
- Soft close suspension drawer(s)
- Solid hardwood base/dentil molding

Notes

- Glides adjust 1"
- Unit has black back panel and is not designed for Open Plan use. Select OPB Option for Open Plan application

Options

Accessories

- K1: Center Drawer - \$290
- K28: Articulating keyboard w/ mouse pad (Installed) - \$390

Drawer

- P6: Modify File/File to Box/Box/File - \$55 per pedestal

Flush Cut

- FC-B: Flush Unit Both Sides(Facing) for Ganging - \$100
- FC-R: Flush Unit Right(Facing) for Ganging - \$100
- FC-L: Flush Unit Left (Facing) for Ganging - \$100

Grommets (Standard Location)

Specify Color - \$50 ea.

- Black: TM30-C (Center)
- Silver: TM31-C (Center)
- Antique Brass: TM33-C (Center)

Grommets (Non-Standard Location)

Provide drawing w/ Grommet Location and Specify Color - \$95 ea.

- Black: TM30-NS
- Silver: TM31-NS
- Antique Brass: TM33-NS

Modesty

- M34T: Drop Door Tech Modesty - \$130
- M51: Open Back Modesty with Wire Mgmt Rail - Deduct \$95

Molding

- DSM1: Delete Dentil Molding Only - n/c

Open Plan _ Finished Back

- OPB: W "G" Style - Modify Unit for Open Plan Application - \$295

Prado

Credenzas
Storage Units

[Click here to view statement of line](#)

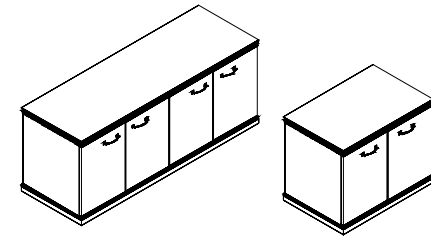

1 Select Model

w" x d" x h"

	Weight
4 Door	
71 x 24 x 29	260
59 x 24 x 29	225
2 Door	
36 x 24 x 29	130
30 x 24 x 29	120

	Standard Veneer Top Standard Veneer Chassis	Premium Veneer Top Premium Veneer Chassis	High Pressure Laminate Top Veneer Chassis	Thermally Fused Laminate Top Thermally Fused Laminate Chassis
	PRA7124CA125W 5641	"P" Option N/A	PRA7124CA125G 5641	"M" Option N/A
	PRA5924CA125W 5389	"P" Option N/A	PRA5924CA125G 5389	"M" Option N/A
	PRA3624CA125W 3300	"P" Option N/A	PRA3624CA125G 3300	"M" Option N/A
	PRA3024CA125W 3133	"P" Option N/A	PRA3024CA125G 3133	"M" Option N/A

Product Features

- Adjustable glides
- 1 Adjustable veneer shelf behind door set
- Solid hardwood base/dentil molding

Notes

- Glides adjust 1"
- Unit has black back panel and is not designed for Open Plan use. Select OPB Option for Open Plan application

Options

Accessories

- REF-01: Modify storage section for refrigerator (Open back/water mat) - \$205

Door

- D2: Door lock - \$100 per door set
- D6: Delete Doors - n/c
- D9SC: Soft Close Door Hinges - \$20 per door

Flush Cut

- FC-B: Flush Unit Both Sides(Facing) for Ganging - \$100
- FC-R: Flush Unit Right(Facing) for Ganging - \$100
- FC-L: Flush Unit Left (Facing) for Ganging - \$100

Grommets (Standard Location)

- Specify Color and Location (Right/Left/Center) - \$50 ea.
- Black: TM30-R (Right), TM30-L (Left), TM30-C (Center)
- Silver: TM31-R (Right), TM31-L (Left), TM31-C (Center)
- Antique Brass: TM33-R (Right), TM33-L (Left), TM33-C (Center)

Grommets (Non-Standard Location)

- Provide drawing w/ Grommet Location and Specify Color - \$95 ea.
- Black: TM30-NS, Silver: TM31-NS, Antique Brass: TM33-NS

Grommets (Vertical Surface)

- Standard Location - \$50 ea. ea.
- Black Plastic Vertical Surface: TM50-C (Bottom Center)
- Non-Standard Location - \$95 ea.
- Black Plastic Vertical Surface: TM50-NS

Molding

- DSM1: Delete Dentil Molding Only - n/c

Open Plan _ Finished Back

- OPB: W "G" Style - Modify Unit for Open Plan Application - \$295

2 Select Finish

[Click to view finishes](#)

3 Select Edge

[Click to view edges](#)



Prado



Prado

4 Select Hardware

[Click to view details](#)



PL-115 Matte Black
PL-116 Matte Nickel

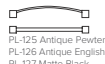

PL-125 Antique Pewter
PL-126 Antique English
PL-127 Matte Black



PL-115 Matte Black
PL-116 Matte Nickel



PL-125 Antique Pewter
PL-126 Antique English
PL-127 Matte Black

Prado

Credenzas
Lateral Files

[Click here to view statement of line](#)

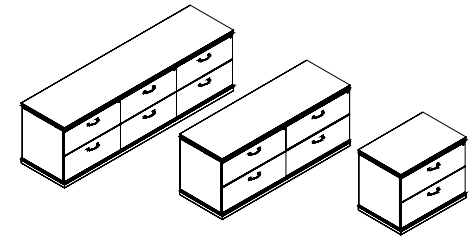

1 Select Model

w" x d" x h"

Weight

		Standard Veneer Top Standard Veneer Chassis		Premium Veneer Top Premium Veneer Chassis		High Pressure Laminate Top Veneer Chassis		Thermally Fused Laminate Top Thermally Fused Laminate Chassis	
6 Drawer									
94 x 24 x 29	525	PRA9424CA104W	9928	"P" Option N/A		PRA9424CA104G	9928	"M" Option N/A	
88 x 24 x 29	490	PRA8824CA104W	9758	"P" Option N/A		PRA8824CA104G	9758	"M" Option N/A	
4 Drawer									
71 x 24 x 29	325	PRA7124CA104W	7298	"P" Option N/A		PRA7124CA104G	7298	"M" Option N/A	
59 x 24 x 29	290	PRA5924CA104W	6965	"P" Option N/A		PRA5924CA104G	6965	"M" Option N/A	
2 Drawer									
36 x 24 x 29	170	PRA3624CA104W	3466	"P" Option N/A		PRA3624CA104G	3466	"M" Option N/A	
30 x 24 x 29	160	PRA3024CA104W	3300	"P" Option N/A		PRA3024CA104G	3300	"M" Option N/A	

2 Select Finish

[Click to view finishes](#)

3 Select Edge

[Click to view edges](#)



Prado



Prado

4 Select Hardware

[Click to view details](#)



PL-115 Matte Black
PL-116 Matte Nickel

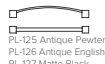

PL-125 Antique Pewter
PL-126 Antique English
PL-127 Matte Black



PL-115 Matte Black
PL-116 Matte Nickel



PL-125 Antique Pewter
PL-126 Antique English
PL-127 Matte Black

Product Features

- Adjustable glides
- Anti-tilt safety feature
- Legal/Double letter filing
- Features ball bearing suspensions, suspensions are full extension.
- Solid hardwood base/dentil molding

Notes

- Glides adjust 1"
- Unit has black back panel and is not designed for Open Plan use. Select OPB Option for Open Plan application

Options

Drawer

- P13: Modify Lateral File To Storage Cabinet - \$100 per pedestal(Use on 4/6 drawer units)

Flush Cut

- FC-B: Flush Unit Both Sides(Facing) for Ganging - \$100
- FC-R: Flush Unit Right(Facing) for Ganging - \$100
- FC-L: Flush Unit Left (Facing) for Ganging - \$100

Molding

- DSM1: Delete Dentil Molding Only - n/c

Open Plan _ Finished Back

- OPB: W "G" Style - Modify Unit for Open Plan Application - \$295

Prado

Credenzas
Vertical Lateral File

[Click here to view statement of line](#)

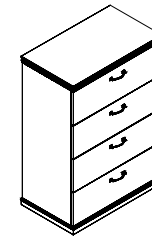

1 Select Model

w" x d" x h"

Freestanding

36 x 24 x 52

30 x 24 x 52

Weight

275
250

Standard Veneer Top Standard Veneer Chassis	Premium Veneer Top Premium Veneer Chassis	High Pressure Laminate Top Veneer Chassis	Thermally Fused Laminate Top Thermally Fused Laminate Chassis
--	--	--	--

PRA3624FI111W	5307
PRA3024FI111W	5141

"P" Option N/A
"P" Option N/A

PRA3624FI111G	5307
PRA3024FI111G	5141

"M" Option N/A
"M" Option N/A

Product Features

- Adjustable glides
- Anti-tilt safety feature
- Legal/Double letter filing
- Features ball bearing suspensions, suspensions are full extension

Notes

- Glides adjust 1"
- Unit has black back panel and is not designed for Open Plan use. Select OPB Option for Open Plan application

Options

Flush Cut

- FC-B: Flush Unit Both Sides(Facing) for Ganging - \$100
- FC-R: Flush Unit Right(Facing) for Ganging - \$100
- FC-L: Flush Unit Left (Facing) for Ganging - \$100

Molding

- DSM1: Delete Dentil Molding Only - n/c

Open Plan _ Finished Back

- OPB: W "G" Style - Modify Unit for Open Plan Application - \$295

2 Select Finish

[Click to view finishes](#)

3 Select Edge

[Click to view edges](#)



Prado



Prado

4 Select Hardware

[Click to view details](#)



PL-115 Matte Black
PL-116 Matte Nickel

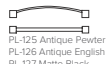

PL-125 Antique Pewter
PL-126 Antique English
PL-127 Matte Black



PL-115 Matte Black
PL-116 Matte Nickel



PL-125 Antique Pewter
PL-126 Antique English
PL-127 Matte Black

Prado

Credenzas
Conference Storage

[Click here to view statement of line](#)

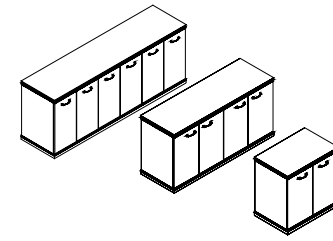

1 Select Model

w" x d" x h"

Weight	6 Door	4 Door	2 Door
94 x 24 x 36	360		
88 x 24 x 36	345		
71 x 24 x 36		270	
59 x 24 x 36		220	
36 x 24 x 36		160	
30 x 24 x 36		150	

Standard Veneer Top Standard Veneer Chassis	Premium Veneer Top Premium Veneer Chassis	High Pressure Laminate Top Veneer Chassis	Thermally Fused Laminate Top Thermally Fused Laminate Chassis
PRA9424CA124W 8803	"P" Option N/A	PRA9424CA124G 8803	"M" Option N/A
PRA8824CA124W 8635	"P" Option N/A	PRA8824CA124G 8635	"M" Option N/A
PRA7124CA124W 6647	"P" Option N/A	PRA7124CA124G 6647	"M" Option N/A
PRA5924CA124W 5865	"P" Option N/A	PRA5924CA124G 5865	"M" Option N/A
PRA3624CA124W 3802	"P" Option N/A	PRA3624CA124G 3802	"M" Option N/A
PRA3024CA124W 3636	"P" Option N/A	PRA3024CA124G 3636	"M" Option N/A

Product Features

- Adjustable glides
- 1 Adjustable veneer shelf behind door set
- Solid hardwood base/dentil molding

Notes

- Glides adjust 1"
- Unit has black back panel and is not designed for Open Plan use. Select OPB Option for Open Plan application

Options

Accessories

- REF-01: Modify storage section for refrigerator (Open back/water mat) - \$205

Door

- D2: Door lock - \$100 per door set
- D6: Delete Doors - n/c
- D9SC: Soft Close Door Hinges - \$20 per door

Flush Cut

- FC-B: Flush Unit Both Sides(Facing) for Ganging - \$100
- FC-R: Flush Unit Right(Facing) for Ganging - \$100
- FC-L: Flush Unit Left (Facing) for Ganging - \$100

Grommets (Standard Location)

- Specify Color and Location (Right/Left/Center) - \$50 ea.
- Black: TM30-R (Right), TM30-L (Left), TM30-C (Center)
- Silver: TM31-R (Right), TM31-L (Left), TM31-C (Center)
- Antique Brass: TM33-R (Right), TM33-L (Left), TM33-C (Center)

Grommets (Non-Standard Location)

- Provide drawing w/ Grommet Location and Specify Color - \$95 ea.
- Black: TM30-NS, Silver: TM31-NS, Antique Brass: TM33-NS

Grommets (Vertical Surface)

- Standard Location - \$50 ea. ea.
- Black Plastic Vertical Surface: TM50-C (Bottom Center)
- Non-Standard Location - \$95 ea.
- Black Plastic Vertical Surface: TM50-NS

Molding

- DSM1: Delete Dentil Molding Only - n/c

Open Plan _ Finished Back

- OPB: W "G" Style - Modify Unit for Open Plan Application - \$295

2 Select Finish

[Click to view finishes](#)

3 Select Edge

[Click to view edges](#)



4 Select Hardware

[Click to view details](#)

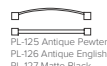

Prado

Credenzas

Buffet Credenza

[Click here to view statement of line](#)

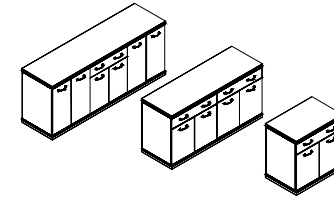

1 Select Model

w" x d" x h"

Weight	6 Door 94 x 24 x 36	4 Door 71 x 24 x 36	2 Door 36 x 24 x 36
350			
300			
160			

Standard Veneer Top Standard Veneer Chassis	Premium Veneer Top Premium Veneer Chassis	High Pressure Laminate Top Veneer Chassis	Thermally Fused Laminate Top Thermally Fused Laminate Chassis
PRA9424CA126W 8499	"P" Option N/A	PRA9424CA126G 8499	"M" Option N/A
PRA7124CA126W 7466	"P" Option N/A	PRA7124CA126G 7466	"M" Option N/A
PRA3624CA126W 3971	"P" Option N/A	PRA3624CA126G 3971	"M" Option N/A

2 Select Finish

[Click to view finishes](#)

3 Select Edge

[Click to view edges](#)



Prado



Prado

4 Select Hardware

[Click to view details](#)

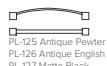

Product Features

- 1 Adjustable veneer shelf behind door set
- Adjustable glides
- Full extension drawers - locking
- Soft close suspension drawer(s)
- Utility drawer with felt liner

Notes

- Glides adjust 1"
- Unit has black back panel and is not designed for Open Plan use. Select OPB Option for Open Plan application

Options

Accessories

- REF-01: Modify storage section for refrigerator (Open back/water mat) - \$205

Door

- D2: Door lock - \$100 per door set
- D6: Delete Doors - n/c
- D9SC: Soft Close Door Hinges - \$20 per door

Flush Cut

- FC-B: Flush Unit Both Sides(Facing) for Ganging - \$100
- FC-R: Flush Unit Right(Facing) for Ganging - \$100
- FC-L: Flush Unit Left (Facing) for Ganging - \$100

Grommets (Standard Location)

- Specify Color and Location (Right/Left/Center) - \$50 ea.
- Black: TM30-R (Right), TM30-L (Left), TM30-C (Center)
- Silver: TM31-R (Right), TM31-L (Left), TM31-C (Center)
- Antique Brass: TM33-R (Right), TM33-L (Left), TM33-C (Center)

Grommets (Non-Standard Location)

- Provide drawing w/ Grommet Location and Specify Color - \$95 ea.
- Black: TM30-NS, Silver: TM31-NS, Antique Brass: TM33-NS

Grommets (Vertical Surface)

- Standard Location - \$50 ea. ea.
- Black Plastic Vertical Surface: TM50-C (Bottom Center)
- Non-Standard Location - \$95 ea.
- Black Plastic Vertical Surface: TM50-NS

Molding

- DSM1: Delete Dentil Molding Only - n/c

Open Plan _ Finished Back

- OPB: W "G" Style - Modify Unit for Open Plan Application - \$295

Prado

Workstation Credenzas
File / File

[Click here to view statement of line](#)

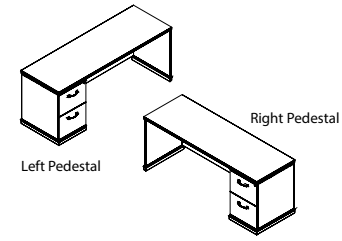

1 Select Model

w" x d" x h"	Weight
88 x 24 x 29	240
71 x 24 x 29	220
65 x 24 x 29	190
88 x 24 x 29	240
71 x 24 x 29	220
65 x 24 x 29	190

Standard Veneer Top Standard Veneer Chassis	Premium Veneer Top Premium Veneer Chassis	High Pressure Laminate Top Veneer Chassis	Thermally Fused Laminate Top Thermally Fused Laminate Chassis
PRA8824CA086W 6141	"P" Option N/A	PRA8824CA086G 6141	"M" Option N/A
PRA7124CA086W 4637	"P" Option N/A	PRA7124CA086G 4637	"M" Option N/A
PRA6524CA086W 4395	"P" Option N/A	PRA6524CA086G 4395	"M" Option N/A
PRA8824CA087W 6141	"P" Option N/A	PRA8824CA087G 6141	"M" Option N/A
PRA7124CA087W 4637	"P" Option N/A	PRA7124CA087G 4637	"M" Option N/A
PRA6524CA087W 4395	"P" Option N/A	PRA6524CA087G 4395	"M" Option N/A

Product Features

- Full extension drawers - locking
- Full fixed modesty
- Soft close suspension drawer(s)
- Solid hardwood base/dentil molding
- Wire management channel

Notes

- Unit has black back panel and is not designed for Open Plan use. Select OPB Option for Open Plan application

Options

Accessories

- K28: Articulating keyboard w/ mouse pad (Installed) - \$390

Drawer

- P6: Modify File/File to Box/Box/File - \$55 per pedestal
- P40B: extra Box/Box/File or File/File to Kneespace - \$1025

Flush Cut

- FC-B: Flush Unit Both Sides(Facing) for Ganging - \$100
- FC-R: Flush Unit Right(Facing) for Ganging - \$100
- FC-L: Flush Unit Left (Facing) for Ganging - \$100

Grommets (Standard Location)

Specify Color - \$50 ea.

- Black: TM30-C (Center)
- Silver: TM31-C (Center)
- Antique Brass: TM33-C (Center)

Grommets (Non-Standard Location)

Provide drawing w/ Grommet Location and Specify Color - \$95 ea.

- Black: TM30-NS
- Silver: TM31-NS
- Antique Brass: TM33-NS

Modesty

- M34T: Drop Door Tech Modesty - \$130
- M51: Open Back Modesty with Wire Mgmt Rail - Deduct \$95

Molding

- DSM1: Delete Dentil Molding Only - n/c

Open Plan _ Finished Back

- OPB: "W" "G" Style - Modify Unit for Open Plan Application - \$295

2 Select Finish

[Click to view finishes](#)

3 Select Edge

[Click to view edges](#)



4 Select Hardware

[Click to view details](#)

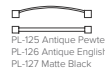
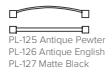

Prado

Workstation Credenzas
Lateral File

[Click here to view statement of line](#)

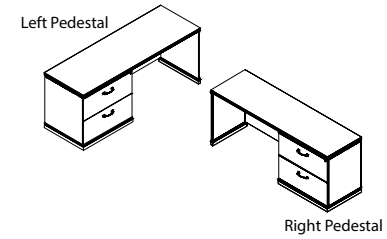

1 Select Model

w" x d" x h"

	Weight
Left Pedestal	
94 x 24 x 29	310
88 x 24 x 29	285
71 x 24 x 29	265
65 x 24 x 29	250
Right Pedestal	
94 x 24 x 29	310
88 x 24 x 29	285
71 x 24 x 29	265
65 x 24 x 29	250

	Standard Veneer Top Standard Veneer Chassis	Premium Veneer Top Premium Veneer Chassis	High Pressure Laminate Top Veneer Chassis	Thermally Fused Laminate Top Thermally Fused Laminate Chassis
	PRA9424CA066W 6647	"P" Option N/A	PRA9424CA066G 6647	"M" Option N/A
	PRA8824CA066W 6477	"P" Option N/A	PRA8824CA066G 6477	"M" Option N/A
	PRA7124CA066W 5307	"P" Option N/A	PRA7124CA066G 5307	"M" Option N/A
	PRA6524CA066W 5141	"P" Option N/A	PRA6524CA066G 5141	"M" Option N/A
	PRA9424CA067W 6647	"P" Option N/A	PRA9424CA067G 6647	"M" Option N/A
	PRA8824CA067W 6477	"P" Option N/A	PRA8824CA067G 6477	"M" Option N/A
	PRA7124CA067W 5307	"P" Option N/A	PRA7124CA067G 5307	"M" Option N/A
	PRA6524CA067W 5141	"P" Option N/A	PRA6524CA067G 5141	"M" Option N/A

Product Features

- Full fixed modesty
- Features ball bearing suspensions, suspensions are full extension
- Solid hardwood base/dentil molding

Notes

- Unit has black back panel and is not designed for Open Plan use. Select OPB Option for Open Plan application
- 94" W & 88"W have 35"W Lateral
- 71" W & 65" W have 29"W Lateral

Options

Accessories

- K28: Articulating keyboard w/ mouse pad (Installed) - \$390

Drawer

- P13: Modify Lateral File To Storage Cabinet - \$100
- P40B: extra Box/Box/File or File/File to Kneespace - \$1025 (n/a on 65" w unit)

Flush Cut

- FC-B: Flush Unit Both Sides(Facing) for Ganging - \$100
- FC-R: Flush Unit Right(Facing) for Ganging - \$100
- FC-L: Flush Unit Left (Facing) for Ganging - \$100

Grommets (Standard Location)

- Specify Color - \$50 ea.
- Black: TM30-C (Center)
 - Silver: TM31-C (Center)
 - Antique Brass: TM33-C (Center)

Grommets (Non-Standard Location)

- Provide drawing w/ Grommet Location and Specify Color - \$95 ea.
- Black: TM30-NS
 - Silver: TM31-NS
 - Antique Brass: TM33-NS

Modesty

- M34T: Drop Door Tech Modesty - \$130
- M51: Open Back Modesty with Wire Mgmt Rail - Deduct \$95

Molding

- DSM1: Delete Dentil Molding Only - n/c

Open Plan _ Finished Back

- OPB: "W" "G" Style - Modify Unit for Open Plan Application - \$295

2 Select Finish

[Click to view finishes](#)

3 Select Edge

[Click to view edges](#)



Prado



Prado

4 Select Hardware

[Click to view details](#)



PL-115 Matte Black
PL-116 Matte Nickel

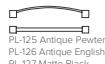

PL-125 Antique Pewter
PL-126 Antique English
PL-127 Matte Black



PL-115 Matte Black
PL-116 Matte Nickel



PL-125 Antique Pewter
PL-126 Antique English
PL-127 Matte Black

Prado

Workstation Credenzas
Multi-File

[Click here to view statement of line](#)

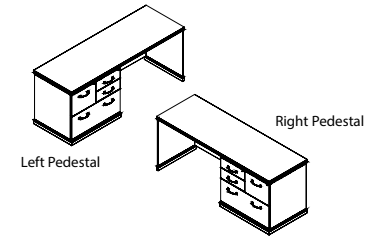

1 Select Model

w" x d" x h"	Weight
94 x 24 x 29	310
88 x 24 x 29	285
71 x 24 x 29	265
65 x 24 x 29	250
Right Pedestal	
94 x 24 x 29	310
88 x 24 x 29	285
71 x 24 x 29	265
65 x 24 x 29	250

Standard Veneer Top Standard Veneer Chassis	Premium Veneer Top Premium Veneer Chassis	High Pressure Laminate Top Veneer Chassis	Thermally Fused Laminate Top Thermally Fused Laminate Chassis
PRA9424CA667W 7145	"P" Option N/A	PRA9424CA667G 7145	"M" Option N/A
PRA8824CA667W 6980	"P" Option N/A	PRA8824CA667G 6980	"M" Option N/A
PRA7124CA667W 5807	"P" Option N/A	PRA7124CA667G 5807	"M" Option N/A
PRA6524CA667W 5641	"P" Option N/A	PRA6524CA667G 5641	"M" Option N/A
Right Pedestal			
PRA9424CA668W 7145	"P" Option N/A	PRA9424CA668G 7145	"M" Option N/A
PRA8824CA668W 6980	"P" Option N/A	PRA8824CA668G 6980	"M" Option N/A
PRA7124CA668W 5807	"P" Option N/A	PRA7124CA668G 5807	"M" Option N/A
PRA6524CA668W 5641	"P" Option N/A	PRA6524CA668G 5641	"M" Option N/A

2 Select Finish

[Click to view finishes](#)

3 Select Edge

[Click to view edges](#)



Prado



Prado

4 Select Hardware

[Click to view details](#)



PL-115 Matte Black
PL-116 Matte Nickel

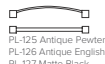

PL-125 Antique Pewter
PL-126 Antique English
PL-127 Matte Black



PL-115 Matte Black
PL-116 Matte Nickel



PL-125 Antique Pewter
PL-126 Antique English
PL-127 Matte Black

Product Features

- Full fixed modesty
- + - iWi & iGi Box and File Drawers feature soft close suspensions (Lateral Drawers Feature ball bearing suspensions)
- Solid hardwood base/dentil molding

Notes

- Unit has black back panel and is not designed for Open Plan use. Select OPB Option for Open Plan application

Options

Accessories

- K28: Articulating keyboard w/ mouse pad (Installed) - \$390 (n/a on 71" and 65")

Drawer

- P40B: extra Box/Box/File or File/File to Kneespace - \$1025 (n/a on 65" w unit)

Flush Cut

- FC-B: Flush Unit Both Sides(Facing) for Ganging - \$100
- FC-R: Flush Unit Right(Facing) for Ganging - \$100
- FC-L: Flush Unit Left (Facing) for Ganging - \$100

Grommets (Standard Location)

Specify Color - \$50 ea.

- Black: TM30-C (Center)
- Silver: TM31-C (Center)
- Antique Brass: TM33-C (Center)

Grommets (Non-Standard Location)

Provide drawing w/ Grommet Location and Specify Color - \$95 ea.

- Black: TM30-NS
- Silver: TM31-NS
- Antique Brass: TM33-NS

Modesty

- M34T: Drop Door Tech Modesty - \$130
- M51: Open Back Modesty with Wire Mgmt Rail - Deduct \$95

Molding

- DSM1: Delete Dentil Molding Only - n/c

Open Plan _ Finished Back

- OPB: "W" "G" Style - Modify Unit for Open Plan Application - \$295

Prado

Overhead Task
Freestanding Panel Door - 6/4/2 Door

[Click here to view statement of line](#)

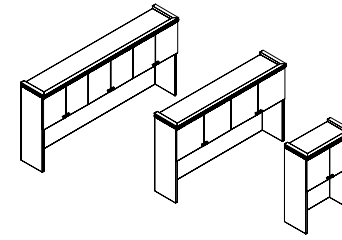

1 Select Model

w" x d" x h"	Weight
6 Door	
94 x 15 x 44	310
88 x 15 x 44	280
4 Door	
83 x 15 x 44	260
76 x 15 x 44	245
71 x 15 x 44	230
65 x 15 x 44	210
59 x 15 x 44	195
48 x 15 x 44	185
2 Door	
36 x 15 x 44	155
30 x 15 x 44	145

Standard Veneer Top Standard Veneer Chassis		Premium Veneer Top Premium Veneer Chassis		High Pressure Laminate Top Veneer Chassis		Thermally Fused Laminate Top Thermally Fused Laminate Chassis	
PRA9444OH325W	7313	"P" Option N/A		"G" Option N/A		"M" Option N/A	
PRA8844OH325W	6647	"P" Option N/A		"G" Option N/A		"M" Option N/A	
PRA8344OH325W	5977	"P" Option N/A		"G" Option N/A		"M" Option N/A	
PRA7644OH325W	5807	"P" Option N/A		"G" Option N/A		"M" Option N/A	
PRA7144OH325W	5641	"P" Option N/A		"G" Option N/A		"M" Option N/A	
PRA6544OH325W	5473	"P" Option N/A		"G" Option N/A		"M" Option N/A	
PRA5944OH325W	5223	"P" Option N/A		"G" Option N/A		"M" Option N/A	
PRA4844OH325W	5017	"P" Option N/A		"G" Option N/A		"M" Option N/A	
PRA3644OH325W	3271	"P" Option N/A		"G" Option N/A		"M" Option N/A	
PRA3044OH325W	3180	"P" Option N/A		"G" Option N/A		"M" Option N/A	

Product Features

- 2" Top cornice frame with dentil molding
- Finished top
- Interior cabinet depth 12.5"
- Interior clearance 15 -5/8"
- 5/8" grommet(s) included for task light wire management

Notes

- Ganged Units Must Be Clearly Noted As To Individual Unit Locations
- Shipped Assembled
- Unit has black back panel and is not designed for Open Plan use. Select OPB Option for Open Plan application

Options

Door

- D2: Door lock - \$100 per door set
- D6: Delete Doors - n/c
- D9SC: Soft Close Door Hinges - \$20 per door

Flush Cut

- FC-B: Flush Unit Both Sides(Facing) for Ganging - \$100
- FC-R: Flush Unit Right(Facing) for Ganging - \$100
- FC-L: Flush Unit Left (Facing) for Ganging - \$100

Grommets (Vertical Surface)

- Standard Location - \$50 ea. ea.
- Black Plastic Vertical Surface: TM50-C (Bottom Center)
- Non-Standard Location - \$95 ea.
- Black Plastic Vertical Surface: TM50-NS

Molding

- DSM: Delete Dentil Molding Only - n/c

Open Plan _ Finished Back

- OPB: W "G" Style - Modify Unit for Open Plan Application - \$395

Task Lighting

Overhead task light cord is located on the right facing side. If the opposite location is required please contact customer service.

- LT-LED24: 24" LED Task light - \$215
- LT-LED48: 48" LED Task light - \$270
- LT-LED60: 60" LED Task light - \$335
- LT-LED72: 72" LED Task light - \$360

2 Select Finish

[Click to view finishes](#)

3 Select Edge

[Click to view edges](#)

Edge
N/A

4 Select Hardware

[Click to view details](#)



DK-125 Antique Pewter
DK-126 Antique English
DK-127 Matte Black

Prado

Overhead Task
Freestanding Wood Frame Leaded/Beveled Glass Doors

[Click here to view statement of line](#)

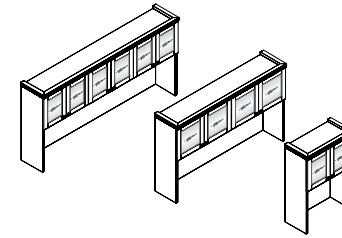

1 Select Model

w" x d" x h"	Weight
6 Door	
94 x 15 x 44	310
88 x 15 x 44	280
4 Door	
83 x 15 x 44	260
76 x 15 x 44	245
71 x 15 x 44	230
65 x 15 x 44	210
59 x 15 x 44	195
2 Door	
36 x 15 x 44	155
30 x 15 x 44	145

Standard Veneer Top Standard Veneer Chassis		Premium Veneer Top Premium Veneer Chassis		High Pressure Laminate Top Veneer Chassis		Thermally Fused Laminate Top Thermally Fused Laminate Chassis	
		"P" Option N/A		"G" Option N/A		"M" Option N/A	
		"P" Option N/A		"G" Option N/A		"M" Option N/A	
		"P" Option N/A		"G" Option N/A		"M" Option N/A	
		"P" Option N/A		"G" Option N/A		"M" Option N/A	
		"P" Option N/A		"G" Option N/A		"M" Option N/A	
		"P" Option N/A		"G" Option N/A		"M" Option N/A	
		"P" Option N/A		"G" Option N/A		"M" Option N/A	
		"P" Option N/A		"G" Option N/A		"M" Option N/A	
		"P" Option N/A		"G" Option N/A		"M" Option N/A	
		"P" Option N/A		"G" Option N/A		"M" Option N/A	

2 Select Finish

[Click to view finishes](#)

3 Select Edge

[Click to view edges](#)

Edge
N/A

4 Select Hardware

[Click to view details](#)



Product Features

- 2" Top cornice frame with dentil molding
- Beveled glass w/ lead bead detailing
- Finished top
- Interior cabinet depth 12.5"
- Interior clearance 15 -5/8"
- Solid wood door frame
- 5/8" grommet(s) included for task light wire management

Notes

- Ganged Units Must Be Clearly Noted As To Individual Unit Locations
- Shipped Assembled
- Unit has black back panel and is not designed for Open Plan use. Select OPB Option for Open Plan application

Options

Door

- D2: Door lock - \$100 per door set
- D6: Delete Doors - n/c
- D9SC: Soft Close Door Hinges - \$20 per door
- D35: Replace glass panel insert with veneer panel insert - \$35 per door

Flush Cut

- FC-B: Flush Unit Both Sides(Facing) for Ganging - \$100
- FC-R: Flush Unit Right(Facing) for Ganging - \$100
- FC-L: Flush Unit Left (Facing) for Ganging - \$100

Grommets (Vertical Surface)

- Standard Location - \$50 ea. ea.
- Black Plastic Vertical Surface: TM50-C (Bottom Center)
- Non-Standard Location - \$95 ea.
- Black Plastic Vertical Surface: TM50-NS

Interior Cabinet Lighting

- LEDPK starter kit includes Infeed, 1 Puck Interior Light and the ability to daisy chain up to 6 total Puck Lights
- LEDPK: LED Puck Starter Kit - \$310
- PK: 1 LED Interior Light - \$130

Task Lighting

- Overhead task light cord is located on the right facing side. If the opposite location is required please contact customer service.
- LT-LED24: 24" LED Task light - \$215
- LT-LED48: 48" LED Task light - \$270
- LT-LED60: 60" LED Task light - \$335
- LT-LED72: 72" LED Task light - \$360

Molding

- DSM1: Delete Dentil Molding Only - n/c

Open Plan _ Finished Back

- OPB: W "G" Style - Modify Unit for Open Plan Application - \$395

DARRAN

Overhead tackboard
Full width tackboards

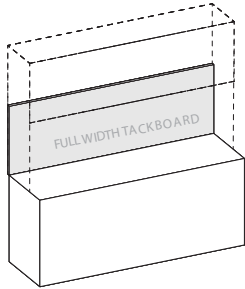

Product Width	Panel Dimension	SKU	COM	1	2	3	4	5	6	7	8	9	10	11/L1	12	13/L2
94	91 x .75 x 21	FTOC9121	379	480	531	582	633	684	735	786	837	888	939	990	1041	1143
88	85 x .75 x 21	FTOC8521	358	449	497	545	593	641	689	737	785	833	881	929	977	1073
84	81 x .75 x 21	FTOC8121	336	428	474	520	566	612	658	704	750	796	842	888	934	1026
77	74 x .75 x 21	FTOC7421	309	392	435	478	521	564	607	650	693	736	779	822	865	951
71	68 x .75 x 21	FTOC6821	282	361	401	441	481	521	561	601	641	681	721	761	801	881
65	62 x .75 x 21	FTOC6221	256	330	366	402	438	474	510	546	582	618	654	690	726	798
59	56 x .75 x 21	FTOC5621	234	299	331	363	395	427	459	491	523	555	587	619	651	715
48	45 x .75 x 21	FTOC4521	187	242	269	296	323	350	377	404	431	458	485	512	539	593
36	33 x .75 x 21	FTOC3321	141	180	200	220	240	260	280	300	320	340	360	380	400	440
30	27 x .75 x 21	FTOC2721	112	149	166	183	200	217	234	251	268	285	302	319	336	370

Standard Features

- Constructed of .5" thick fiberboard
- Fabric is precisely aligned and fitted to the tackboard
- Adhered to the rigid hardboard with staples
- Hung with Z-Strip mounting system

Notes

- Fabric Tack Panels are raised 3" from bottom edge when TM50 grommet is ordered

Overhead tackboard
Half width tackboards

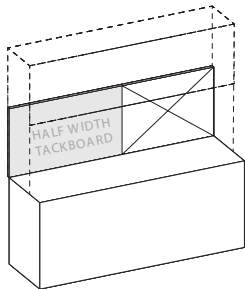

Product Width	Panel Dimension	SKU	COM	1	2	3	4	5	6	7	8	9	10	11/L1	12	13/L2
94 Half Width	45.5 x .75 x 21	FTOC4521	189	240	266	292	318	344	370	396	422	448	474	500	526	578
88 Half Width	42.5 x .75 x 21	FTOC4221	179	225	249	273	297	321	345	369	393	417	441	465	489	537
84 Half Width	40.5 x .75 x 21	FTOC4021	168	214	237	260	283	306	329	352	375	398	421	444	467	513
77 Half Width	37 x .75 x 21	FTOC3721	155	196	217	238	259	280	301	322	343	364	385	406	427	469
71 Half Width	34 x .75 x 21	FTOC3421	141	180	200	220	240	260	280	300	320	340	360	380	400	440
65 Half Width	31 x .75 x 21	FTOC3121	128	165	183	201	219	237	255	273	291	309	327	345	363	399

Standard Features

- Constructed of .5" thick fiberboard
- Fabric is precisely aligned and fitted to the tackboard
- Adhered to the rigid hardboard with staples
- Hung with Z-Strip mounting system

Notes

- Half width tackboards can be specified and combined with a Veneer Panel, Marker Board, or Glass Board. See "Half Width" items under product width.
- Specify right or left facing tackboard
- Fabric Tack Panels are raised 3" from bottom edge when TM50 grommet is ordered

DARRAN

Overhead dry marker board
Full width dry marker board

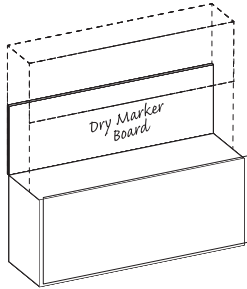

Product Width	Panel Dimension	SKU	List
94	91 x .5 x 21	DMOC9121	1136
88	85 x .5 x 21	DMOC8521	1061
84	81 x .5 x 21	DMOC8121	1011
77	74 x .5 x 21	DMOC7421	924
71	68 x .5 x 21	DMOC6821	849
65	62 x .5 x 21	DMOC6221	774
59	56 x .5 x 21	DMOC5621	699
48	45 x .5 x 21	DMOC4521	587
36	33 x .5 x 21	DMOC3321	437
30	27 x .5 x 21	DMOC2721	337

Standard Features

- Dry marker panel has edge trim molding
- Standard magnetic surface

- Hung with Z-Strip mounting system

Overhead dry marker board
Half width dry marker board

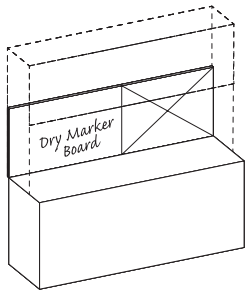

Product Width	Panel Dimension	SKU	List
94 Half Width	45.5 x .5 x 21	DMOC4521	555
88 Half Width	42.5 x .5 x 21	DMOC4221	518
84 Half Width	40.5 x .5 x 21	DMOC4021	493
77 Half Width	37 x .5 x 21	DMOC3721	449
71 Half Width	34 x .5 x 21	DMOC3421	437
65 Half Width	31 x .5 x 21	DMOC3121	374

Standard Features

- Dry marker panel has edge trim molding
- Standard magnetic surface
- Hung with Z-Strip mounting system

Notes

- Half width dry marker boards can be specified and combined with a Tackboard, Veneer Panel, or Glass Board. See "Half Width" items under product width.
- Specify right or left facing dry marker board

DARRAN

Overhead glassboard
Full width glassboard

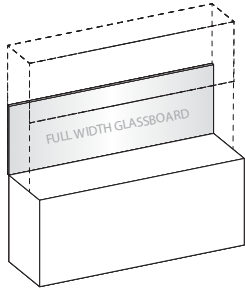

Product Width	Panel Dimension	SKU	List
94	91 x .5 x 21	GBOC9121	2382
88	85 x .5 x 21	GBOC8521	2236
84	81 x .5 x 21	GBOC8121	2138
77	74 x .5 x 21	GBOC7421	1969
71	68 x .5 x 21	GBOC6821	1822
65	62 x .5 x 21	GBOC6221	1676
59	56 x .5 x 21	GBOC5621	1531
48	45 x .5 x 21	GBOC4521	1264
36	33 x .5 x 21	GBOC3321	972
30	27 x .5 x 21	GBOC2721	826

Standard Features

- 4 mm tempered glass

Notes

- Earth magnets are required to hold items securely in place
- Hung with Z-Strip mounting system
- Use glass cleaner or alcohol to clean
- Standard dry erase markers may be used

Overhead glassboard
Half width glassboard

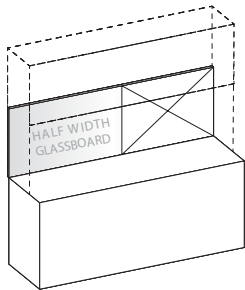

Product Width	Panel Dimension	SKU	List
94 Half Width	45.5 x .5 x 21	GBOC4521	1251
88 Half Width	42.5 x .5 x 21	GBOC4221	1178
84 Half Width	40.5 x .5 x 21	GBOC4021	1129
77 Half Width	37 x .5 x 21	GBOC3721	985
71 Half Width	34 x .5 x 21	GBOC3421	972
65 Half Width	31 x .5 x 21	GBOC3121	899

Standard Features

- 4 mm tempered glass
- Hung with Z-Strip mounting system

Notes

- Half width glassboards can be specified and combined with a Tackboard, Veneer panel, Marker Board. See "Half Width" items under product width.
- Specify right or left facing glassboard
- Use glass cleaner or alcohol to clean
- Standard dry erase markers may be used
- Earth magnets are required to hold items securely in place

Prado

Wall Hung Cabinets
Single Height Panel Doors - 6/4/2 Door

[Click here to view statement of line](#)

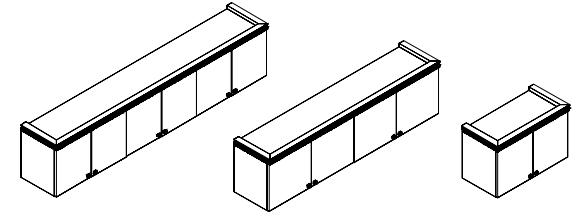

1 Select Model

w" x d" x h"	Weight
6 Door	
94 x 15 x 20	190
88 x 15 x 20	175
4 Door	
84 x 15 x 20	165
76 x 15 x 20	155
71 x 15 x 20	145
65 x 15 x 20	130
2 Door	
59 x 15 x 20	120
48 x 15 x 20	110
36 x 15 x 20	75
30 x 15 x 20	65

	Standard Veneer Top Standard Veneer Chassis	Premium Veneer Top Premium Veneer Chassis	High Pressure Laminate Top Veneer Chassis	Thermally Fused Laminate Top Thermally Fused Laminate Chassis
		"P" Option N/A	"G" Option N/A	"M" Option N/A
		"P" Option N/A	"G" Option N/A	"M" Option N/A
		"P" Option N/A	"G" Option N/A	"M" Option N/A
		"P" Option N/A	"G" Option N/A	"M" Option N/A
		"P" Option N/A	"G" Option N/A	"M" Option N/A
		"P" Option N/A	"G" Option N/A	"M" Option N/A
		"P" Option N/A	"G" Option N/A	"M" Option N/A
		"P" Option N/A	"G" Option N/A	"M" Option N/A
		"P" Option N/A	"G" Option N/A	"M" Option N/A
		"P" Option N/A	"G" Option N/A	"M" Option N/A

Product Features

- 2" Top cornice frame with dentil moldings on 3 sides
- Interior cabinet depth 12"
- Prices include ganging mitre fit as specified
- Wall mount rail included

Notes

- The DARRAN wall mounted cabinet(or shelf) must be hung on a weight-bearing wall. The suitability of the wall supporting the wall mounted cabinet, and the installation and maintenance of the wall-mounted cabinet, is the sole responsibility of the customer. Failure to correctly install and/or exceed the loaded weight capacity of this product may cause it to fall, resulting in damage to the product, adjacent property and/or bodily injury.
- Can only gang with other wall cabinets. Cannot gang with overheads or towers.

Options

- Door**
 - D2: Door lock - \$100 per door set
 - D6: Delete door - n/c
 - D9SC: Soft Close Door Hinges - \$20 per door
- Flush Cut**
 - FC-B: Flush Unit Both Sides(Facing) for Ganging - \$100
 - FC-R: Flush Unit Right(Facing) for Ganging - \$100
 - FC-L: Flush Unit Left (Facing) for Ganging - \$100
- Molding**
 - DSM: Delete Dentil Molding Only - n/c
- Task Lighting**
 - Overhead task light cord is located on the right facing side. If the opposite location is required please contact customer service.
 - LT-LED24: 24" LED Task light - \$215
 - LT-LED48: 48" LED Task light - \$270
 - LT-LED60: 60" LED Task light - \$335
 - LT-LED72: 72" LED Task light - \$360

2 Select Finish

[Click to view finishes](#)

3 Select Edge

[Click to view edges](#)

Edge
N/A

4 Select Hardware

[Click to view details](#)



DK-125 Antique Pewter
DK-126 Antique English
DK-127 Matte Black

Prado

Wall Hung Cabinets
Single Height Wood Frame Leaded/Beveled Glass Doors

[Click here to view statement of line](#)

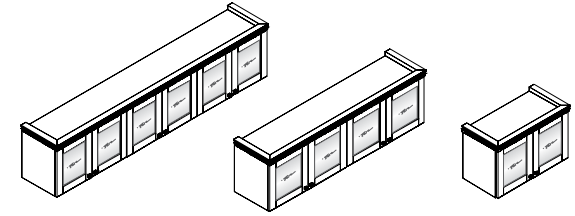

1 Select Model

w" x d" x h"	Weight
6 Door	
94 x 15 x 20	190
88 x 15 x 20	175
4 Door	
71 x 15 x 20	145
65 x 15 x 20	130
59 x 15 x 20	120
2 Door	
36 x 15 x 20	75
30 x 15 x 20	65

	Standard Veneer Top Standard Veneer Chassis	Premium Veneer Top Premium Veneer Chassis	High Pressure Laminate Top Veneer Chassis	Thermally Fused Laminate Top Thermally Fused Laminate Chassis
		"P" Option N/A	"G" Option N/A	"M" Option N/A
		"P" Option N/A	"G" Option N/A	"M" Option N/A
		"P" Option N/A	"G" Option N/A	"M" Option N/A
		"P" Option N/A	"G" Option N/A	"M" Option N/A
		"P" Option N/A	"G" Option N/A	"M" Option N/A
		"P" Option N/A	"G" Option N/A	"M" Option N/A
		"P" Option N/A	"G" Option N/A	"M" Option N/A
		"P" Option N/A	"G" Option N/A	"M" Option N/A

2 Select Finish

[Click to view finishes](#)

3 Select Edge

[Click to view edges](#)

Edge
N/A

4 Select Hardware

[Click to view details](#)



Product Features

- 2" Top cornice frame with dentil moldings on 3 sides
- Interior cabinet depth 12"
- Prices include ganging mitre fit as specified
- Wall mount rail included

Notes

- The DARRAN wall mounted cabinet(or shelf) must be hung on a weight-bearing wall. The suitability of the wall supporting the wall mounted cabinet, and the installation and maintenance of the wall-mounted cabinet, is the sole responsibility of the customer. Failure to correctly install and/or exceed the loaded weight capacity of this product may cause it to fall, resulting in damage to the product, adjacent property and/or bodily injury.
- Can only gang with other wall cabinets. Cannot gang with overheads or towers.

Options

Door

- D2: Door Lock - \$100 per door set
- D6: Delete Doors - n/c
- D9SC: Soft Close Door Hinges - \$20 per door
- D35: Replace glass panel insert with veneer panel insert - \$35 per door

Flush Cut

- FC-B: Flush Unit Both Sides(Facing) for Ganging - \$100
- FC-R: Flush Unit Right(Facing) for Ganging - \$100
- FC-L: Flush Unit Left (Facing) for Ganging - \$100

Interior Cabinet Lighting

- LEDPK starter kit includes Infeed, 1 Puck Interior Light and the ability to daisy chain up to 6 total Puck Lights
- LEDPK: LED Puck Starter Kit - \$310
- PK: 1 LED Interior Light - \$130

Task Lighting

- Overhead task light cord is located on the right facing side. If the opposite location is required please contact customer service.
- LT-LED24: 24" LED Task light - \$215
- LT-LED48: 48" LED Task light - \$270
- LT-LED60: 60" LED Task light - \$335
- LT-LED72: 72" LED Task light - \$360

Molding

- DSM1: Delete Dentil Molding Only - n/c

DARRAN

Wall hung tackboards Full width tackboards

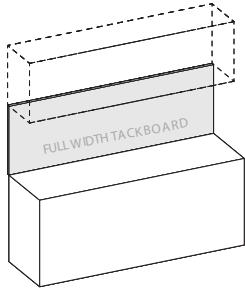

Product Width	Panel Dimension	SKU	COM	1	2	3	4	5	6	7	8	9	10	11/L1	12	13/L2
94	93 x .75 x 24	FTWH9324	465	576	627	678	729	780	831	882	933	984	1035	1086	1137	1239
88	87 x .75 x 24	FTWH8724	448	539	587	635	683	731	779	827	875	923	971	1019	1067	1163
84	83 x .75 x 24	FTWH8324	422	514	560	606	652	698	744	790	836	882	928	974	1020	1112
77	76 x .75 x 24	FTWH7624	388	471	514	557	600	643	686	729	772	815	858	901	944	1030
71	70 x .75 x 24	FTWH7024	355	434	474	514	554	594	634	674	714	754	794	834	874	954
65	64 x .75 x 24	FTWH6424	322	396	432	468	504	540	576	612	648	684	720	756	792	864
59	58 x .75 x 24	FTWH5824	294	359	391	423	455	487	519	551	583	615	647	679	711	775
48	47 x .75 x 24	FTWH4724	236	291	318	345	372	399	426	453	480	507	534	561	588	642
36	35 x .75 x 24	FTWH3524	176	217	237	257	277	297	317	337	357	377	397	417	437	477
30	29 x .75 x 24	FTWH2924	142	179	196	213	230	247	264	281	298	315	332	349	366	400

Standard Features

- Constructed of .5" thick fiberboard
- Fabric is precisely aligned and fitted to the tackboard
- Adhered to the rigid hardboard with staples

- Hung with Z-Strip mounting system

Wall hung tackboards Half width tackboards

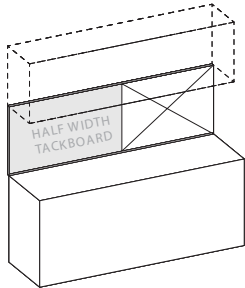

Product Width	Panel Dimension	SKU	COM	1	2	3	4	5	6	7	8	9	10	11/L1	12	13/L2
94 Half Width	46.5 x .75 x 24	FTWH4624	233	288	313	338	363	388	413	438	463	488	513	538	563	613
88 Half Width	43.5 x .75 x 24	FTWH4324	225	270	294	318	342	366	390	414	438	462	486	510	534	582
84 Half Width	41.5 x .75 x 24	FTWH4124	211	257	280	303	326	349	372	395	418	441	464	487	510	556
77 Half Width	38 x .75 x 24	FTWH3824	194	235	256	277	298	319	340	361	382	403	424	445	466	508
71 Half Width	35 x .75 x 24	FTWH3524	178	217	237	257	277	297	317	337	357	377	397	417	437	477
65 Half Width	32 x .75 x 24	FTWH3224	161	198	216	234	252	270	288	306	324	342	360	378	396	432

Standard Features

- Constructed of .5" thick fiberboard
- Fabric is precisely aligned and fitted to the tackboard
- Adhered to the rigid hardboard with staples
- Hung with Z-Strip mounting system

Notes

- Half width tackboards can be specified and combined with a Veneer Panel, Marker Board, or Glass Board. See "Half Width" items under product width.
- Specify right or left facing tackboard

DARRAN

Wall hung dry marker board
Full width dry marker board

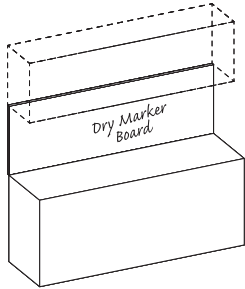

Product Width	Panel Dimension	SKU	List
94	93 x .75 x 24	DMWH9324	1161
88	87 x .75 x 24	DMWH8724	1086
84	83 x .75 x 24	DMWH8324	1023
77	76 x .75 x 24	DMWH7624	948
71	70 x .75 x 24	DMWH7024	874
65	64 x .75 x 24	DMWH6424	799
59	58 x .75 x 24	DMWH5824	724
48	47 x .75 x 24	DMWH4724	587
36	35 x .75 x 24	DMWH3524	437
30	29 x .75 x 24	DMWH2924	362

Standard Features

- Dry marker panel has edge trim molding
- Standard magnetic surface
- Hung with Z-Strip mounting system

Wall hung dry marker board
Half width dry marker board

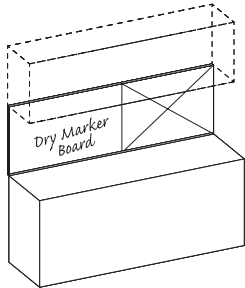

Product Width	Panel Dimension	SKU	List
94 Half Width	46.5 x .75 x 24	DMWH4624	580
88 Half Width	43.5 x .75 x 24	DMWH4324	543
84 Half Width	41.5 x .75 x 24	DMWH4124	518
77 Half Width	38 x .75 x 24	DMWH3824	474
71 Half Width	35 x .75 x 24	DMWH3524	437
65 Half Width	32 x .75 x 24	DMWH3224	399

Standard Features

- Dry marker panel has edge trim molding
- Standard magnetic surface
- Hung with Z-Strip mounting system

Notes

- Half width dry marker boards can be specified and combined with a Tackboard, Veneer Panel, or Glass Board. See "Half Width" items under product width.
- Specify right or left facing dry marker board

DARRAN

Wall hung veneer panel
Full width veneer panel

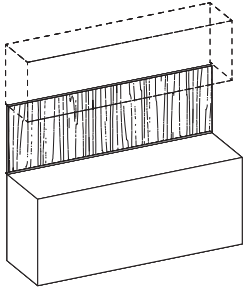

Product Width	Panel Dimension	SKU	List
94	93 x .75 x 24	VPWH9324	967
88	87 x .75 x 24	VPWH8724	905
84	83 x .75 x 24	VPWH8324	853
77	76 x .75 x 24	VPWH7624	790
71	70 x .75 x 24	VPWH7024	728
65	64 x .75 x 24	VPWH6424	666
59	58 x .75 x 24	VPWH5824	603
48	47 x .75 x 24	VPWH4724	489
36	35 x .75 x 24	VPWH3524	364
30	29 x .75 x 24	VPWH2924	302

Standard Features

- Veneer edges

Notes

- Vertical wire channels on back for task light cords
- Steel mounting wall channel is recessed for flush mounting
- Hung with Z-Strip mounting system
- Can be used with or without overhead cabinet
- Required for other accessory panels

Wall hung veneer panel
Half width veneer panel

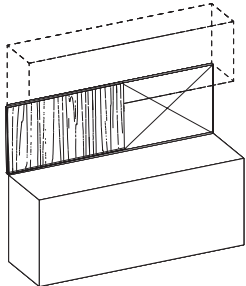

Product Width	Panel Dimension	SKU	List
94 Half Width	46.5 x .75 x 24	VPWH4624	484
88 Half Width	43.5 x .75 x 24	VPWH4324	452
84 Half Width	41.5 x .75 x 24	VPWH4124	432
77 Half Width	38 x .75 x 24	VPWH3824	395
71 Half Width	35 x .75 x 24	VPWH3524	364
65 Half Width	32 x .75 x 24	VPWH3224	333

Standard Features

- Veneer edges
- Vertical wire channels on back for task light cords
- Steel mounting wall channel is recessed for flush mounting
- Hung with Z-Strip mounting system

Notes

- Half width veneer panels can be specified and combined with a Tackboard, Marker Board, or Glass Board. See "Half Width" items under product width.
- Specify right or left facing veneer panel
- Can be used with or without overhead cabinet.
- Required for other accessory panels.

DARRAN

Wall hung glassboard Full width glassboards

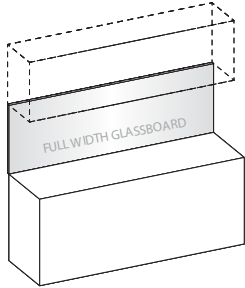

Product Width	Panel Dimension	SKU	List
94	93 x .75 x 24	GBWH9324	2753
88	87 x .75 x 24	GBWH8724	2586
84	83 x .75 x 24	GBWH8324	2475
77	76 x .75 x 24	GBWH7624	2281
71	70 x .75 x 24	GBWH7024	2114
65	64 x .75 x 24	GBWH6424	1948
59	58 x .75 x 24	GBWH5824	1780
48	47 x .75 x 24	GBWH4724	1476
36	35 x .75 x 24	GBWH3524	1142
30	29 x .75 x 24	GBWH2924	976

Standard Features

- 4 mm tempered glass

Notes

- Earth magnets are required to hold items securely in place
- Hung with Z-Strip mounting system
- Use glass cleaner or alcohol to clean
- Standard dry erase markers may be used

Wall hung glassboard Half width glassboards

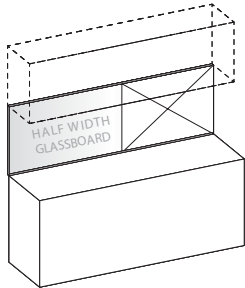

Product Width	Panel Dimension	SKU	List
94 Half Width	46.5 x .75 x 24	GBWH4624	1461
88 Half Width	43.5 x .75 x 24	GBWH4324	1378
84 Half Width	41.5 x .75 x 24	GBWH4124	1323
77 Half Width	38 x .75 x 24	GBWH3824	1232
71 Half Width	35 x .75 x 24	GBWH3524	1142
65 Half Width	32 x .75 x 24	GBWH3224	1059

Standard Features

- 4 mm tempered glass

Notes

- Half width glassboards can be specified and combined with a Tackboard, Veneer panel, Marker Board. See "Half Width" items under product width.
- Specify right or left facing glassboard
- Use glass cleaner or alcohol to clean
- Standard dry erase markers may be used
- Earth magnets are required to hold items securely in place
- Hung with Z-Strip mounting system

Prado

Ganging - Overhead Tower - Panel Doors
Wardrobe / Storage

[Click here to view statement of line](#)

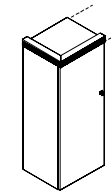

Door Hinged Left

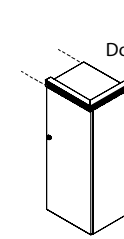

Door Hinged Right

1 Select Model

w" x d" x h"

Hinged Left

17.5 x 15 x 44

14.5 x 15 x 44

Hinged Right

17.5 x 15 x 44

14.5 x 15 x 44

Weight

		Standard Veneer Top Standard Veneer Chassis	Premium Veneer Top Premium Veneer Chassis	High Pressure Laminate Top Veneer Chassis	Thermally Fused Laminate Top Thermally Fused Laminate Chassis
	100	PRA1744OH340W 2889	"P" Option N/A	"G" Option N/A	"M" Option N/A
	85	PRA1444OH340W 2806	"P" Option N/A	"G" Option N/A	"M" Option N/A
	100	PRA1744OH341W 2889	"P" Option N/A	"G" Option N/A	"M" Option N/A
	85	PRA1444OH341W 2806	"P" Option N/A	"G" Option N/A	"M" Option N/A

Product Features

- 3/4" Veneer adjustable shelves
- 2 Adjustable shelves
- Flush on one end so you can gang with overhead consoles/overhead bookcase hutches
- Interior shelf depth 12"
- Prices include ganging mitre fit as specified

Notes

- Ganged Units Must Be Clearly Noted As To Individual Unit Locations
- Unit has black back panel and is not designed for Open Plan use. Select OPB Option for Open Plan application

Options

Door

- D2: Door lock - \$100 per door
- D6: Delete Doors - n/c
- D9SC: Soft Close Door Hinges - \$20 per door

Molding

- DSM1: Delete Dentil Molding Only - n/c

Open Plan _ Finished Back

- OPB: "W" "G" Style - Modify Unit for Open Plan Application - \$395

2 Select Finish

[Click to view finishes](#)

3 Select Edge

[Click to view edges](#)

Edge
N/A

4 Select Hardware

[Click to view details](#)



DK-125 Antique Pewter
DK-126 Antique English
DK-127 Matte Black

Prado

Overhead Tower
Ganging Wardrobe / Leaded/Beveled Glass Doors

[Click here to view statement of line](#)

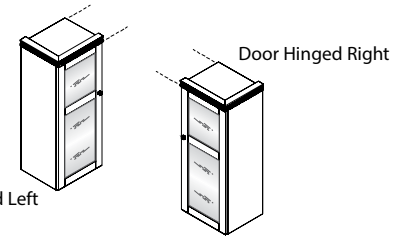

1 Select Model

w" x d" x h"	Weight
Hinged Left	
17.5 x 15 x 44	100
14.5 x 15 x 44	85
Hinged Right	
17.5 x 15 x 44	100
14.5 x 15 x 44	85

Standard Veneer Top Standard Veneer Chassis	Premium Veneer Top Premium Veneer Chassis	High Pressure Laminate Top Veneer Chassis	Thermally Fused Laminate Top Thermally Fused Laminate Chassis
PRA1744OH342W 3225	"P" Option N/A	"G" Option N/A	"M" Option N/A
PRA1444OH342W 3139	"P" Option N/A	"G" Option N/A	"M" Option N/A
PRA1744OH343W 3225	"P" Option N/A	"G" Option N/A	"M" Option N/A
PRA1444OH343W 3139	"P" Option N/A	"G" Option N/A	"M" Option N/A

Product Features

- 3/4" Veneer adjustable shelves
- 2 Adjustable shelves
- Flush on one end so you can gang with overhead consoles/overhead bookcase hutches
- Interior shelf depth 12"
- Prices include ganging mitre fit as specified
- Solid wood door frame

Notes

- Ganged Units Must Be Clearly Noted As To Individual Unit Locations
- Unit has black back panel and is not designed for Open Plan use. Select OPB Option for Open Plan application

Options

- Door**
- D2: Door lock - \$100 per door
 - D9SC: Soft Close Door Hinges - \$20 per door
 - D35: Replace glass panel insert with veneer panel insert - \$35 per door
- Interior Cabinet Lighting**

- LEDPK starter kit includes Infeed, 1 Puck Interior Light and the ability to daisy chain up to 6 total Puck Lights
- LEDPK: LED Puck Starter Kit - \$310
 - PK: 1 LED Interior Light - \$130

- Molding**
- DSM1: Delete Dentil Molding Only - n/c
- Open Plan _ Finished Back**
- OPB: "W" "G" Style - Modify Unit for Open Plan Application - \$395

- Shelf**
- GS14H: Replace Standard Shelves with Glass Shelves - \$90 per shelf

2 Select Finish

[Click to view finishes](#)

3 Select Edge

[Click to view edges](#)

Edge
N/A

4 Select Hardware

[Click to view details](#)



Prado

Overhead Bookcase Hutches Bookcase/Hutch Overhead

[Click here to view statement of line](#)

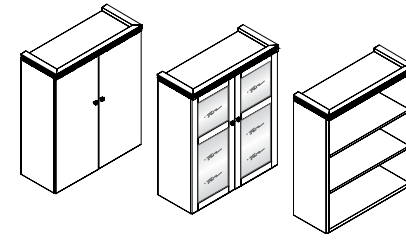

1 Select Model

w" x d" x h"
Panel Door
36 x 15 x 44
30 x 15 x 44
Leaded/Beveled Glass Doors

Weight

		Standard Veneer Top Standard Veneer Chassis	Premium Veneer Top Premium Veneer Chassis	High Pressure Laminate Top Veneer Chassis	Thermally Fused Laminate Top Thermally Fused Laminate Chassis
36 x 15 x 44	130	PRA3644OH570W 3414	"P" Option N/A	"G" Option N/A	"M" Option N/A
30 x 15 x 44	125	PRA3044OH570W 3247	"P" Option N/A	"G" Option N/A	"M" Option N/A
36 x 15 x 44	120	PRA3644OH552W 4083	"P" Option N/A	"G" Option N/A	"M" Option N/A
30 x 15 x 44	115	PRA3044OH552W 3918	"P" Option N/A	"G" Option N/A	"M" Option N/A
Open Bookcase					
36 x 15 x 44	100	PRA3644OH551W 2912	"P" Option N/A	"G" Option N/A	"M" Option N/A
30 x 15 x 44	90	PRA3044OH551W 2747	"P" Option N/A	"G" Option N/A	"M" Option N/A

2 Select Finish

[Click to view finishes](#)

3 Select Edge

[Click to view edges](#)

Edge
N/A

4 Select Hardware

[Click to view details](#)



Product Features

- 2" Top cornice frame with dentil molding
- 2 Adjustable shelves
- Interior shelf depth 12"
- Prices include ganging mitre fit as specified

Notes

- Unit has black back panel and is not designed for Open Plan use. Select OPB Option for Open Plan application

Options

Door

- D2: Door lock - \$100 per door
- D6: Delete Doors - n/c
- D9SC: Soft Close Door Hinges - \$20 per door
- D35: Replace glass panel insert with veneer panel insert - \$35 per door

Flush Cut

- FC-B: Flush Unit Both Sides(Facing) for Ganging - \$100
- FC-R: Flush Unit Right(Facing) for Ganging - \$100
- FC-L: Flush Unit Left (Facing) for Ganging - \$100

Interior Cabinet Lighting

LEDPK starter kit includes Infeed, 1 Puck Interior Light and the ability to daisy chain up to 6 total Puck Lights

- LEDPK: LED Puck Starter Kit - \$310
- PK: 1 LED Interior Light - \$130

Molding

- DSM1: Delete Dentil Molding Only - n/c

Open Plan _ Finished Back

- OPB: "W" "G" Style - Modify Unit for Open Plan Application - \$395

Shelf

- GS14F: Replace Standard Shelves with Glass Shelves - \$90 per shelf
- S714F: Replace Standard Shelf with Heavy Duty Lumber 1" Shelf - \$80 per shelf ("M" Styles - n/a)

Prado

Half Towers

Ganging Vertical Wardrobe Panel Door

[Click here to view statement of line](#)

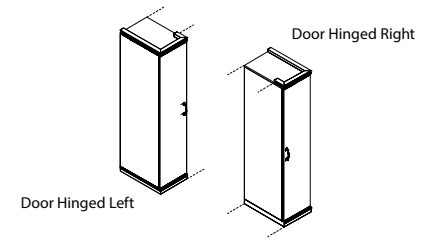

1 Select Model

w" x d" x h"

Hinged Left

16 x 24 x 73

Hinged Right

16 x 24 x 73

Weight

170

170

Standard Veneer Top Standard Veneer Chassis	Premium Veneer Top Premium Veneer Chassis	High Pressure Laminate Top Veneer Chassis	Thermally Fused Laminate Top Thermally Fused Laminate Chassis
--	--	--	--

PRA1673TW283W 3971

"P" Option N/A

"G" Option N/A

"M" Option N/A

PRA1673TW284W 3971

"P" Option N/A

"G" Option N/A

"M" Option N/A

Product Features

- Hardwood base/cornice/dentil molding
- Prices include ganging mitre fit as specified
- Wardrobe w/ coat rod & hook

Notes

- Unit has black back panel and is not designed for Open Plan use. Select OPB Option for Open Plan application
- Flush on one end so you can gang with overhead consoles / overhead bookcase hutches

Options

Door

- D2: Door lock - \$100 per door
- D6: Delete Doors - n/c
- D9SC: Soft Close Door Hinges - \$20 per door

Freestanding

- FREE-ST: unit for freestanding use - \$105

Molding

- DSM1: Delete Dentil Molding Only - n/c

Open Plan _ Finished Back

- OPB: "W" "G" Style - Modify Unit for Open Plan Application - \$395

2 Select Finish

[Click to view finishes](#)

3 Select Edge

[Click to view edges](#)

Edge
N/A

4 Select Hardware

[Click to view details](#)

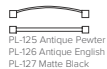

Prado

Vertical Full Tower

Freestanding Panel Door - Wardrobe / Storage

[Click here to view statement of line](#)

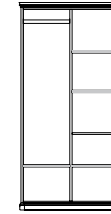
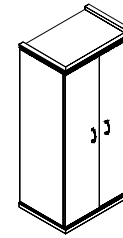

1 Select Model

w" x d" x h"

36 x 24 x 73

30 x 24 x 73

Weight

350

315

Standard Veneer Top Standard Veneer Chassis		Premium Veneer Top Premium Veneer Chassis	High Pressure Laminate Top Veneer Chassis	Thermally Fused Laminate Top Thermally Fused Laminate Chassis
--	--	--	--	--

PRA3673TW275W	6810
PRA3073TW275W	6647

"P" Option N/A
"P" Option N/A

"G" Option N/A
"G" Option N/A

"M" Option N/A
"M" Option N/A

Product Features

- 3 Adjustable shelves, 1 fixed
- Hardwood base/cornice/dentil molding
- Prices include ganging mitre fit as specified
- Wardrobe w/ coat rod & hook

Notes

- Unit has black back panel and is not designed for Open Plan use. Select OPB Option for Open Plan application
- Ganging: Factory modified cornice top & base to fit specified ganging locations

Options

Door

- D2: Door lock - \$100 per door
- D6: Delete Doors - n/c
- D9SC: Soft Close Door Hinges - \$20 per door

Delete Center Partition

- MOD31: Delete Center Partition / Add (3) Full Width Adj. Shelves & (1) Fixed - \$295

Flush Cut

- FC-B: Flush Unit Both Sides(Facing) for Ganging - \$100
- FC-R: Flush Unit Right(Facing) for Ganging - \$100
- FC-L: Flush Unit Left (Facing) for Ganging - \$100

Molding

- DSM1: Delete Dentil Molding Only - n/c

Open Plan _ Finished Back

- OPB: "W" "G" Style - Modify Unit for Open Plan Application - \$395

2 Select Finish

[Click to view finishes](#)

3 Select Edge

[Click to view edges](#)

Edge
N/A

4 Select Hardware

[Click to view details](#)

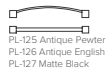

Prado

Vertical Full Tower
Freestanding File / Wardrobe - Panel Door

[Click here to view statement of line](#)

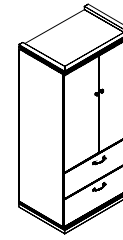

1 Select Model

w" x d" x h"	Weight
36 x 24 x 73	360
30 x 24 x 73	325

Standard Veneer Top Standard Veneer Chassis		Premium Veneer Top Premium Veneer Chassis	High Pressure Laminate Top Veneer Chassis	Thermally Fused Laminate Top Thermally Fused Laminate Chassis
PRA3673TW281W	7313	"P" Option N/A	"G" Option N/A	"M" Option N/A
PRA3073TW281W	7145	"P" Option N/A	"G" Option N/A	"M" Option N/A

Product Features

- 3 Adjustable shelves, 1 fixed
- Can be ganged to 15" or 24" deep towers
- Hardwood base/cornice/dentil molding
- Features ball bearing suspensions, suspensions are full extension
- Wardrobe w/ coat rod & hook

Notes

- Unit has black back panel and is not designed for Open Plan use. Select OPB Option for Open Plan application
- Ganging: Factory modified cornice top & base to fit specified ganging locations

Options

Door

- D2: Door lock - \$100 per door
- D6: Delete Doors - n/c
- D9SC: Soft Close Door Hinges - \$20 per door

Delete Center Partition

- MOD30: Delete Center Partition / Add (2) Full Width Adj. Shelves - \$295
- When deleting Center partition (1) D2 Door lock should be specified.

Flush Cut

- FC-B: Flush Unit Both Sides(Facing) for Ganging - \$100
- FC-R: Flush Unit Right(Facing) for Ganging - \$100
- FC-L: Flush Unit Left (Facing) for Ganging - \$100

Molding

- DSM1: Delete Dentil Molding Only - n/c

Open Plan _ Finished Back

- OPB: "W" "G" Style - Modify Unit for Open Plan Application - \$395

2 Select Finish

[Click to view finishes](#)

3 Select Edge

[Click to view edges](#)

Edge
N/A

4 Select Hardware

[Click to view details](#)

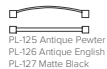

Prado

Vertical Full Tower Wardrobe / File / Storage
Freestanding Panel Door

[Click here to view statement of line](#)

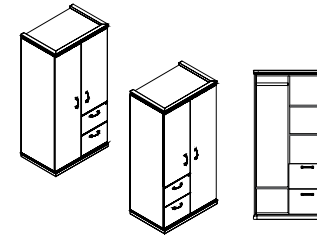

1 Select Model

w" x d" x h"
Wardrobe Left
36 x 24 x 73
Wardrobe Right
36 x 24 x 73

Weight

Standard Veneer Top Standard Veneer Chassis	Premium Veneer Top Premium Veneer Chassis	High Pressure Laminate Top Veneer Chassis	Thermally Fused Laminate Top Thermally Fused Laminate Chassis
--	--	--	--

350
350

PRA3673TW273W 7313
PRA3673TW274W 7313

"P" Option N/A
"P" Option N/A

"G" Option N/A
"G" Option N/A

"M" Option N/A
"M" Option N/A

2 Select Finish

[Click to view finishes](#)

3 Select Edge

[Click to view edges](#)

Edge
N/A

4 Select Hardware

[Click to view details](#)

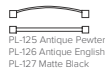

Product Features

- 2 Adjustable shelves, 1 fixed
- Full extension drawers - locking
- Hardwood base/cornice/dentil molding
- Wardrobe w/ coat rod & hook

Notes

- Unit has black back panel and is not designed for Open Plan use. Select OPB Option for Open Plan application

Options

Door

- D2: Door lock - \$100 per door
- D6: Delete Doors - n/c
- D9SC: Soft Close Door Hinges - \$20 per door

Drawers

- P6: Modify File/File to Box/Box/File - \$55 per pedestal

Molding

- DSM1: Delete Dentil Molding Only - n/c

Open Plan _ Finished Back

- OPB: "W" "G" Style - Modify Unit for Open Plan Application - \$395

Flush Cut

- FC-B: Flush Unit Both Sides(Facing) for Ganging - \$100
- FC-R: Flush Unit Right(Facing) for Ganging - \$100
- FC-L: Flush Unit Left (Facing) for Ganging - \$100

Prado

Bookcases
Freestanding Open Bookcases

[Click here to view statement of line](#)

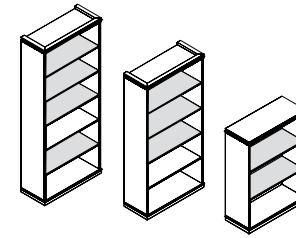

1 Select Model

w" x d" x h"	Weight
30" Width	
30 x 15 x 85	165
30 x 15 x 73	160
30 x 15 x 50	110
36" Width	
36 x 15 x 85	185
36 x 15 x 73	180
36 x 15 x 50	120

	Standard Veneer Top Standard Veneer Chassis	Premium Veneer Top Premium Veneer Chassis	High Pressure Laminate Top Veneer Chassis	Thermally Fused Laminate Top Thermally Fused Laminate Chassis
		"P" Option N/A	"G" Option N/A	"M" Option N/A
	PRA3085BK250W 3802	"P" Option N/A	"G" Option N/A	"M" Option N/A
	PRA3073BK250W 3300	"P" Option N/A	"G" Option N/A	"M" Option N/A
	PRA3050BK250W 2965	"P" Option N/A	"G" Option N/A	"M" Option N/A
		"P" Option N/A	"G" Option N/A	"M" Option N/A
	PRA3685BK250W 4303	"P" Option N/A	"G" Option N/A	"M" Option N/A
	PRA3673BK250W 3802	"P" Option N/A	"G" Option N/A	"M" Option N/A
	PRA3650BK250W 3466	"P" Option N/A	"G" Option N/A	"M" Option N/A

Product Features

- Hardwood base/cornice/dentil molding
- Interior shelf depth 12"
- "W" styles - 50" H units finished top, 73", 85" H units black painted top

Notes

- Adjustable shelves are shaded
- Unit has black back panel and is not designed for Open Plan use. Select OPB Option for Open Plan application

Options

Flush Cut

- FC-B: Flush Unit Both Sides(Facing) for Ganging - \$100
- FC-R: Flush Unit Right(Facing) for Ganging - \$100
- FC-L: Flush Unit Left (Facing) for Ganging - \$100

Interior Cabinet Lighting

- LEDPK starter kit includes Infeed, 1 Puck Interior Light and the ability to daisy chain up to 6 total Puck Lights
- LEDPK: LED Puck Starter Kit - \$310
- PK: 1 LED Interior Light - \$130

Molding

- DSM1: Delete Dentil Molding Only - n/c

Open Plan _ Finished Back

- OPB: "W" "G" Style - Modify Unit for Open Plan Application - \$395

Shelf

- GS14F: Bookcase glass shelf 29" -35" - \$90 Each
- S714F: Heavy Duty Lumber Core Shelves (Replaces Std. Shelves) - \$80 per shelf

2 Select Finish

[Click to view finishes](#)

3 Select Edge

[Click to view edges](#)

Edge
N/A

4 Select Hardware

[Click to view details](#)

Hardware
N/A



COMPUTER SUPPORT
single monitor arm

Style Number	List Price
MA1	280

Specifications

- Available in black or silver
- Desk clamp and mounting included
- Easy assembly and flexibility
- Elastic painting process for a durable and beautiful finish
- Gas spring tension adjustment for counter-balance height adjustment for monitors 1-8 KG
- Gas spring tested to 50,000 repetitions
- Hidden cable management



COMPUTER SUPPORT
double monitor arm

Style Number	List Price
MA2	450

Specifications

- Available in black or silver
- Desk clamp and mounting included
- Easy assembly and flexibility
- Elastic painting process for a durable and beautiful finish
- Gas spring tension adjustment for counter-balance height adjustment for monitors 1-8 KG
- Gas spring tested to 50,000 repetitions
- Hidden cable management



COMPUTER SUPPORT
triple monitor arm

Style Number	List Price
MA3	530

Specifications

- Available in black or silver
- Desk clamp and mounting included
- Easy assembly and flexibility
- Elastic painting process for a durable and beautiful finish
- Gas spring tension adjustment for counter-balance height adjustment for monitors 1-8 KG
- Gas spring tested to 50,000 repetitions
- Hidden cable management



COMPUTER SUPPORT
quadruple monitor arm

Style Number	List Price
MA4	705

Specifications

- Available in black
- Desk clamp and mounting included
- Easy assembly and flexibility
- Elastic painting process for a durable and beautiful finish
- Gas spring tension adjustment for counter-balance height adjustment for monitors 1-8 KG
- Gas spring tested to 50,000 repetitions
- Hidden cable management

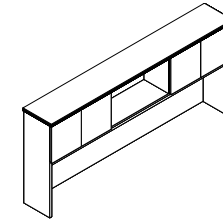
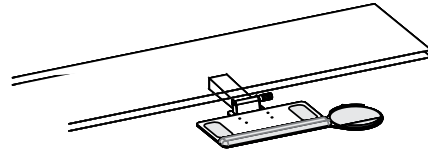
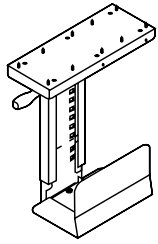

COMPUTER SUPPORT
cpu retractable cradle

COMPUTER SUPPORT
articulating keyboard tray

DOOR MODIFICATIONS
soft close door hinge

DOOR MODIFICATIONS
delete doors

Style Number	List Price
K18	205

Style Number	List Price
Factory Installed	
K28	390
Field Installed	
K28F	415

Style Number	List Price
D9SC	20 Per door

Style Number	List Price
D6	N/C

Specifications

- Black Metal CPU Carriage
- Full 360° swivel capability allows easy access to rear of CPU for cables / wires
- Track allows 8- 1/2" extension
- Width Adjustment 5-1/2" to 9-1/4"
- Height adjustment 14- 5/8" to 20- 1/2"
- Black epoxy finish

Notes
- Factory Installed

Specifications

- Adjusts effortlessly - A simple one-handed motion allows the keyboard to be repositioned instantly, without the use of locks or levers
- Encourages low-risk postures - Maximizes adjustability within a safe operating range.
- Will last a lifetime - Exceeds all applicable BIFMA Standards and comes with a lifetime guarantee.

Notes
- Available on: Freestanding Desk
- Factory Installed (standard)
- FIELD INSTALL - \$415

Specifications

- Snap onto standard door hinge
- Requires (2) per door
- Max door height 43"
- Factory installed where specified
- Individually shipped for field installation

Notes
- Specify Each Item To Have Slow Close Feature

Specifications

- Standard Door overheads and cabinets can have door deleted for open access. Modification of hinge rails and structural components are made face ready.

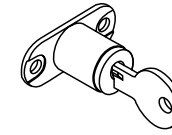
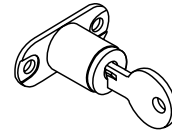
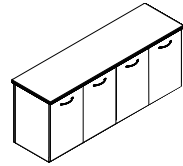
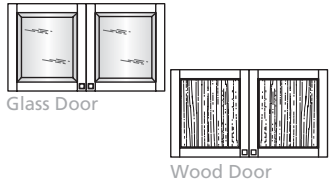

DOOR MODIFICATIONS
replace glass panel insert with veneer panel insert

Style Number	List Price
D35	35 Per door

DOOR MODIFICATIONS
delete doors/replace

Style Number	List Price
D6A	

DOOR MODIFICATIONS
panel door lock

Style Number	List Price
D2	100 Per door set

DOOR MODIFICATIONS
glass door lock

Style Number	List Price
D2-G	205 Per door set

Specifications

- Replace glass panel insert with veneer panel insert

Notes

- Not Available on "M" skus
- Glass door has beveled glass
- Wood door w/ veneer insert - only available on "W" style

Specifications

- Delete doors

Notes

- Available on: All Storage "W"/"G" Style Credenzas.

Specifications

- Door Locks - 1 Door w/ Lock, Other Door w/ Catch Latch
- Contact Customer Service regarding limited lock locations and keying.

Notes

- Available on: Panel Doors, Wood Frame Doors, and Silverluma doors

Specifications

- Door Locks - 1 Door w/ Lock, Other Door w/ Catch Latch
- Contact Customer Service regarding limited lock locations and keying.

Notes

- Available on: Glass Doors

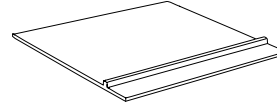
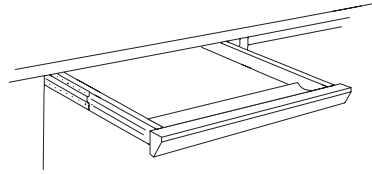
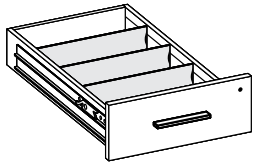

DRAWER OPTIONS
box drawer accessories

Style Number	List Price
Wood Drawer Dividers w/ Clips K-DIV	SET OF 3 - 30
Single Tray - Utility Tray K-Sut	35 ea.

DRAWER OPTIONS
prado center drawer - veneer bottom

Style Number	List Price
Factory Installed K1	290
Field Installed KIF	290

DRAWER OPTIONS - BOTTOM COVER
felt bottom center drawer insert liner

Style Number	List Price
K3	100

GLASSBOARD ACCESSORIES
glassboard accessory kit

Style Number	List Price
GBKIT	290

Specifications

- K-DIV Extra Wood Drawer Dividers with Clips, Top Box drawers standard with 1 divider
- K-SUT Single Tray - Utility Tray, Specify Legal or Letter drawer width

Specifications

- Ball bearing smooth operation
- Drawer has lifetime guarantee
- Solid hardwood front
- Standard with matching wood grain pencil tray

Specifications

- Inserts into center drawer and features divider for open pen and pencil storage. Removable for easy cleaning.
- Adds a luxurious touch to center drawers.
- Color: Dark Brown Coal

Specifications

- 8 Earth magnets, 1 magnetic marker cup holder and 1 magnetic dry eraser

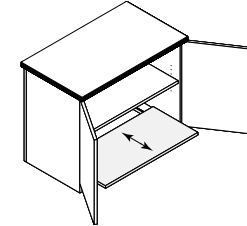
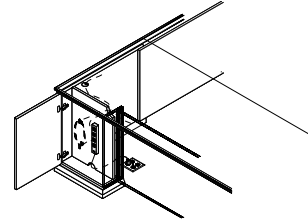
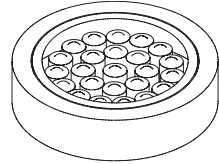

TASK LIGHTING
lt-led task light

Style Number	List Price
24" Task light LT-LED24	215
48" Task light LT-LED48	270
60" Task light LT-LED60	335
72" Task light LT-LED72	360

Specifications

- 6.5' Power cord. Switch with touch dimmer
- 36 LEDs per foot
- 4.6 Watts per foot
- 91 Lumens per watt
- Please note when ganging.
- Overhead tasklight cord is located on the right facing side. If the opposite location is required please contact customer service.

LIGHTING
led interior cabinet puck light

Style Number	List Price
Starter Kit LEDPK	310
1 LED Interior Puck Light PK	130

Specifications

- Starter kit includes Infeed, 1 Puck Interior Light and the ability to daisy chain up to 6 total Puck Lights
- (1) LED Puck Light with 30W power drive and switch
- Recessed fixture
- 12V linking cord 98"L
- Silver finish
- 50,000 hour life
- 2 watt per light

Notes

- Available on: Overhead/Tower Units with glass doors or no doors
- Power drive included, Light only

PEDESTAL MODIFICATIONS
breakfront pedestal with wire management cavity door

Style Number	List Price
PC10 Power Supply Cordset PD717	100
	100

Specifications

- Hinged pedestal front door offers easy access for wire management
- Wire hooks provide wire coil storage
- Wire access openings allow access to floor, cabinets interior and kneespace
- Cabinet interior is black finish
- Top grommet is positioned over cavity for access ease
- (Power Strip Optional)

Notes

- Breakfront Chassis Only

PEDESTAL MODIFICATIONS
black laminate printer pullout bottom shelf

Style Number	List Price
PPOS	225

Specifications

- Black Laminate pullout shelf on suspension
- Black grommet
- Adjustable Shelf

DARRAN

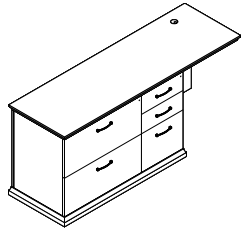

PEDESTAL MODIFICATIONS
add veneer kneespace cabinets - base

Style Number	List Price
Add Box/Box/File or File/File P40B	1025
Add Lateral File 29" W P41B	1255
Add Multi-File - 31"W P42B	1255
Add Storage With Doors 29"W P43B	1140
Add CPU /Printer Cabinet - Open P44B	1140

Specifications

- Multi-file specify Box/Box Left or Right

Notes

- Add additional Standard Cabinets To Kneespace Area.

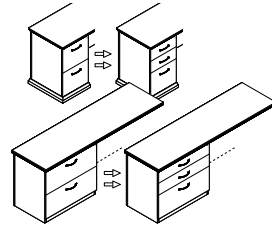

PEDESTAL MODIFICATIONS
modify drawer configurations

Style Number	List Price
File/File to Box/Box/File P6	55 Per ped
Box/Box/File to File/File P6	55 Per ped
Lateral File to 2 Box Drawers P8	100 Per ped

Specifications

- Modify File/File To Box/Box/File - Any Unit

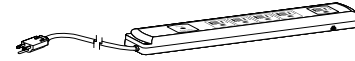

POWER / DATA
power supply cordset

Style Number	List Price
PD717	100

Specifications

- SIZE: 10.75"L x 2.0"W x 1.06"H
- (5) Outlets w/ 10' cord
- Surge suppression (720 Joules)
- 15 Amp breaker
- Available on: Vertical Panels, Cabinet Interiors, and under tops

Prado Options

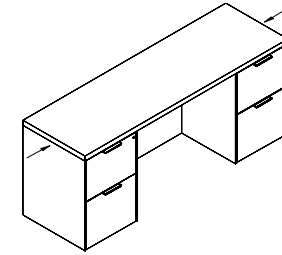

PRODUCT MODIFICATIONS
modify width - open kneespace

Style Number	List Price
MOD-1	125

Specifications

- Modify width down on any unit with an open kneespace: desk, workstation credenza, bridge, return

DARRAN

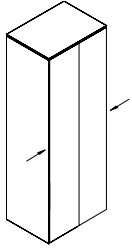

PRODUCT MODIFICATIONS
 modify width - open/closed storage

Style Number	List Price
MOD-2	250

Specifications

- Modify width down on any unit with open or closed storage section: overheads, wall hung units, storage credenzas, towers

PRODUCT MODIFICATIONS
 modify width - outside of mod-1, mod-2

Style Number	List Price
MOD-3	Contact for pricing

Specifications

- Width modification outside of MOD-1 & MOD-2

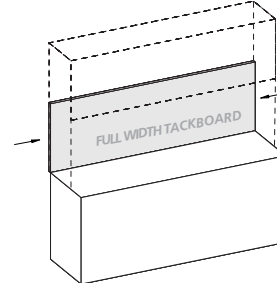

PRODUCT MODIFICATIONS
 modify width - tackboard, veneer panel, or a glassboard

Style Number	List Price
MOD-4	50

Specifications

- Modify width down on tackboard, veneer panel, or a overhead glassboard

Prado Options

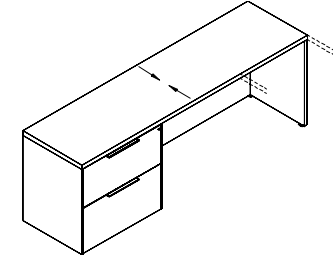

PRODUCT MODIFICATIONS
 modify depth - decrease depth

Style Number	List Price
MOD-5	125

Specifications

- Modify depth down (minimum depth for a unit with drawers is 21"D)

Notes
 - Ex. 24" to 21", 30" to 24", and 36" to 30"

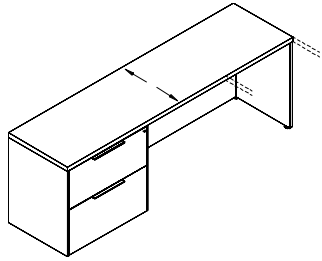

PRODUCT MODIFICATIONS
modify depth - increase depth

Style Number	List Price
MOD-6	Add 10%

Specifications

- Increase depth by no more than 6"

Notes

- Ex. 24" to 30", 30" to 36", and 36" to 42"
- Add 10% to the unit you want to increase the depth of by no more than 6"

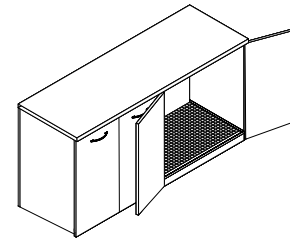

REFRIGERATOR MODIFICATION
refrigerator cabinet modification

Style Number	List Price
REF01	205

Specifications

- Open back cutout for venting
- Moisture sponge mat
- Contaminate ledge
- Contact customer service for maximum refrigerator size (Changes based on unit).

Notes

- Available on: 36" and 42" Storage Credenzas

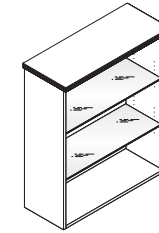

SHELF MODIFICATIONS
glass shelves - tempered full width
26" - 35"

Style Number	List Price
26"W - 35"W x 14"D Shelf GS14F	90

Specifications

- Glass Shelves Replace Wood Shelf In Open Or Glass Door Cabinet. Also Order Interior Cabinet Lighting.

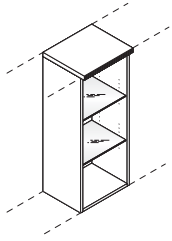

SHELF MODIFICATIONS

tempered glass shelves for half cabinet 17- 1/2" widths

Style Number	List Price
14-1/2"W - 17- 1/2"W x 14"D Shelf GS14H	70 ea.

Specifications

- Glass Shelves Replace Wood Shelf In Open Or Glass Door Cabinet. Also Order Interior Cabinet Lighting.

Notes

- Replace only adjustable shelves between cabinet light and fixed lower wood shelf.

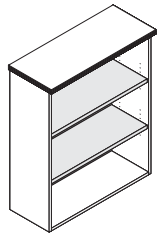

SHELF MODIFICATIONS

heavy duty solid wood bookcase replacement shelves

Style Number	List Price
1" Wood Shelf 14" Deep S714F	80 ea.
1" Wood Shelf 24" Deep S714FX	160 ea.

Specifications

- 1" Solid Lumber Core Shelves Replace Standard 3/4" Plywood Adjustable And Fixed Shelves

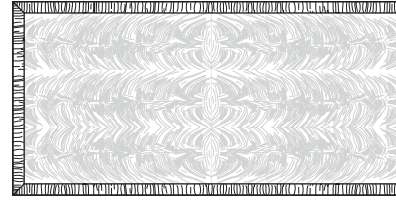

SPECIALTY VENEER ACCENTS

crotch mahogany infield with mitered border

Style Number	List Price
TCB-1 - 84 x 36/42	Contact For Pricing
TCB-2 - 72 x 36/42	Contact For Pricing
TCB-3 - 72 x 30/36	Contact For Pricing

Specifications

- Center balanced butt and book matched crotch mahogany
- 35 sheen non-rubbed finish ensures maximum durability

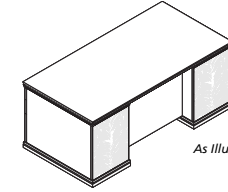

As Illustrated: (2) FCC1

Desk Approach Pedestal Fronts

SPECIALTY VENEER ACCENTS
crotch mahogany desk pedestal fronts

Style Number	List Price
FCC1	Contact For Pricing

Specifications

- Center balanced butt and book matched crotch mahogany
- 35 sheen non-rubbed finish ensures maximum durability

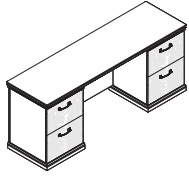

Box/Box/File or File/File
Drawer Fronts



All Three Illustrations Represent: (1) FCC2



Both Illustrations
Represent: FCC3



52" Center Balance Butt
& Bookmatch

SPECIALTY VENEER ACCENTS
crotch mahogany drawer fronts

Style Number	List Price
FCC1	Contact For Pricing

SPECIALTY VENEER ACCENTS
crotch mahogany double width panel
fronts

Style Number	List Price
FCC2	Contact For Pricing

SPECIALTY VENEER ACCENTS
crotch mahogany double width/
double height fronts

Style Number	Contact For Pricing
FCC3	

Specifications

- Center balanced butt and book matched crotch mahogany
- 35 sheen non-rubbed finish ensures maximum durability

Specifications

- Center balanced butt and book matched crotch mahogany
- 35 sheen non-rubbed finish ensures maximum durability

Specifications

- Center balanced butt and book matched crotch mahogany
- 35 sheen non-rubbed finish ensures maximum durability

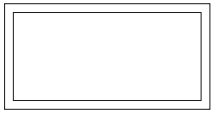

RECTANGLE INLAY

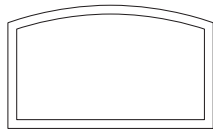

CURVED INLAY

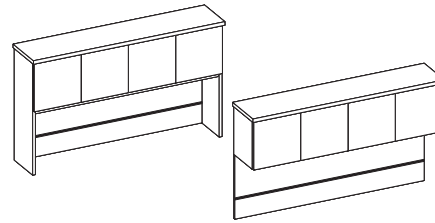

SPECIALTY VENEER ACCENTS

rectangle inlay - ebony hardwood inlay detail

Style Number	List Price
T10SA	Contact For Pricing

SPECIALTY VENEER ACCENTS

bowfront inlay - ebony hardwood inlay detail

Style Number	List Price
T11SA	Contact For Pricing

TOOL CHANNEL ACCESSORIES

recessed aluminum tool channel

Style Number	List Price
ATB02	5 per 1"W

Specifications

- 3/16" x 3/16" thick hardwood ebony inlay is handfitted and glued into routed top and sanded flush with surface
- Inlay is finished over with all finish steps

Notes
- Ebony inlay not recommended in: Koko Cherry

Specifications

- 3/16" x 3/16" thick hardwood ebony inlay is handfitted and glued into routed top and sanded flush with surface
- Inlay is finished over with all finish steps

Notes
- Ebony inlay not recommended in: Koko Cherry

Specifications

- Anodized aluminum finish
- Fully recessed
- Finish matches anodized aluminum accessories
- Can be specified with fabric tack surface mounted above channel

Notes
- If using tool channel with wallhung overhead, a veneer panel must be specified.

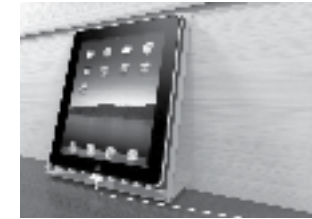
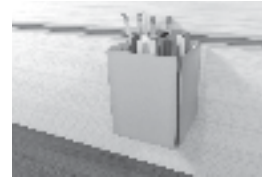
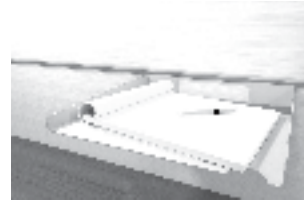

TOOL CHANNEL ACCESSORIES
iphone holder

TOOL CHANNEL ACCESSORIES
large shelf

TOOL CHANNEL ACCESSORIES
pencil pen holder

TOOL CHANNEL ACCESSORIES
tablet holder

Style Number	List Price
ATB31	125

Style Number	List Price
ATB35	135

Style Number	List Price
ATB38	120

Style Number	List Price
ATB30	145

Specifications

- For Console/Wall Hung Back Panels With Optional Tool Bar
- 18 Gauge Steel - Stamp Formed
- Silver Powdercoat Finish
- 5" x 3 -3/4"W
- Non-slip Neoprene pad

Specifications

- 12"W x 10"D

Specifications

- For Console/Wall Hung Back Panels With Optional Tool Bar
- 18 Gauge Steel - Stamp Formed
- Silver Powdercoat Finish
- 5"H x 4"W x 4"D

Specifications

- For Console/Wall Hung Back Panels With Optional Tool Bar
- 18 Gauge Steel - Stamp Formed
- Silver Powdercoat Finish
- 10" x 8"W
- Non-slip Neoprene pad

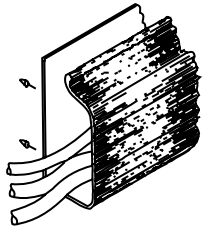

WIRE MANAGEMENT
horizontal j-channel wire
management raceway

Style Number	List Price
W1	80 Per 4' section

Specifications

- 4' section for field installation.
- The "J" shape black thermoplastic wire raceway may be added to specified worksurface tops to provide concealed channeling of wires to and from worksurface grommets. For use in open kneespace areas, raceway is attachable to top of back panel with pan head screws. Interior dimensions are 1" x 1- 1/2" providing ample storage for multiple wires and excess cable. Front of raceway flexes out for easy cord insertion.

- Notes
- Units w/ Wire Channel Standard.
 - Field Installation

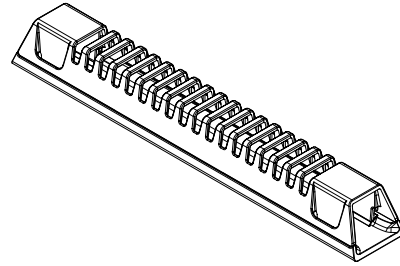

WIRE MANAGEMENT
horizontal wire management raceway

Style Number	List Price
W21	35

Specifications

- 10"W x 1.5"D x 1.25"H
- Gray Wire Manager (10.5")
- Power and data cables can be discretely housed and managed with the W21 Gray Wire Manager. This can be mounted in any location to metal frame or underside of conference tables and runs cables through a 1" channel from power module to hollow steel legs. This keeps cables organized under the table top. Release clips make it simple to snap on and off the Wire Manager for easy organization and access after attached to the table

- Notes
- Field installed

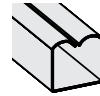

WIRE MANAGEMENT
horizontal u-channel wire
management raceway

Style Number	List Price
W2A	80 Per 4' section

Specifications

- 4' section for field installation.
- Units w/ Wire Channel Standard.
- Field Installation

- Notes
- Units w/ Wire Channel Standard.
 - Field Installation



WIRE MANAGEMENT
coil wire manager

Style Number	List Price
W18	160

Specifications

- Weighted Base, Table attachment plate
- 39- 1/2" Length
- Black

- Notes
- Location

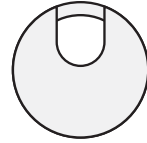
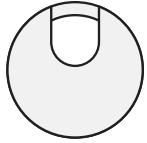

WIRE MANAGEMENT

standard location grommets - factory installed

Style Number	List Price
Standard Location Grommet	
Black	
TM30	50
Silver	
TM31	50
Antique Brass	
TM33	50
White	
TM34	50

Specifications

- 1 -5/8" Metal Grommet

Notes

- *Units w/ Grommets Standard Are Noted Under Standard Features. Grommets Match Pull Finish - Standard (Unless Specified Otherwise)

WIRE MANAGEMENT

non-standard location grommets - factory installed

Style Number	List Price
Non-Standard Location Grommet	
Black	
TM30 -NS	95
Silver	
TM31 -NS	95
Antique Brass	
TM33 -NS	95
White	
TM34 -NS	95

Specifications

- 1 -5/8" Metal Grommet

Notes

- *Units w/ Grommets Standard Are Noted Under Standard Features. Grommets Match Pull Finish - Standard (Unless Specified Otherwise)

WIRE MANAGEMENT

black plastic vertical surface grommets - factory installed

Style Number	List Price
Standard Location Grommet	
TM50-C	50
Non-Standard Location Grommet	
TM50-NS	95

Specifications

- 2 " Black Plastic Grommet

Notes

- Standard Location is Bottom Center

Aircharge wireless charging grommet

Style Number	List Price
 ACWG WIRELESS GROMMET	\$213

Specifications

- > When used with GROVE Tables an additional \$350 LIST will apply for the special cutout required.
- > AirCharge offers a convenient way to charge any Qi compatible smartphone or device without the need to carry charging cables or find an available power outlet.
- > The Aircharge is powered by the latest Qi compliant IC offering reliable and efficient wireless charging in a convenient 3" grommet hub. Simply place your phone on the Aircharge and an LED will confirm pairing and begin wireless charging.
- > Recess: Efficient space conservation and quick access
- > Input: DC 5V (with included AC power adapter), DC 9V, 1.67A (with optional QC 2.0 power adapter)
- > Output: 5 watts Max. with DC 5V, 2A power adapter, 10 watts Max. with QC 2.0 power adapter
- > Qi V1.2 compliant IC
- > Charging distance: 6mm Max.

Available: All DARRAN collections



Cove power unit - non-linking

Style Number	List Price
--------------	------------



PD-COVE PLUG	\$600
--------------	-------

Non-linking version

Specifications

- > Size 5.75"L x 2.5"W
- > (2) 15 Amp Receptacles and (2) USB charging ports
- > Surface Mount
- > 108" Cord
- > Standard Silver Finish, Available in White or Black Finish upon request
- > ETL Listed

Available: All DARRAN collections



Cove corded series

Style Number

List Price



PD-COVE-PKO

\$872

Specifications

- > Size 9.5"L x 2.5"W x 3.18"D
- > When used with GROVE Tables an additional \$350 LIST will apply for the special cutout required.
- > (2) Power Receptacles, (2) 2.1 Amp USB charging ports and (1) Telecom Plate Knockout
- > Surface Mount
- > 108" Cord
- > Standard Silver Finish, Available in White or Black Finish upon request
- > ETL Listed

Available: All DARRAN collections

Telecom Plates

RJ45 (1)	\$55
RJ45 (2)	\$110
RJ45 (3)	\$160
USB (1)	\$70
USB (2)	\$140
RJ11/RJ45	\$110
RJ45/USB	\$125
RJ45/HDMI	\$210
HDMI/DVI	\$325
HDMI/USB	\$205
HDMI/VGA	\$240
VGA/MINI-STEREO	\$155
VGA/USB	\$175

This pod can have up to 1 total plates.
 *All telecom connectors sold separately.



Soba wire manager

Style Number	List Price
STARTER UNITS	
SCDW	\$218
White wire manager	
SCDB	\$218
Black wire manager	

Specifications

- > Dimensions: 9ft x 9in x 3.15in
- > Zips up, bundles and routes loose, messy cables into a single tube
- > Routes and guides cables behind desks, TVs, and anywhere cables tend to get messy
- > Accommodates large or small cables, up to three cables at once
- > Support channels, used to route cables, include powerful adhesive backing which allows easy attachment to surfaces.

Available: All DARRAN collections



VILLA Power unit - non-linking

Style Number	List Price
 VIL-C PLUG	\$562
Non-Linking	

Specifications

- > Size: Top Grommet 5.68"L X 3.39"W; Under Top 12"L x 3.13"W x 3.08"D
- > (2) Power receptacles; (2) USB charging ports and (1) Knockouts for RJ45 Data Ports
- > Surface Mount
- > 72" Cord (Longer cord available, contact Customer Service)
- > Standard Silver Finish, Black Finish available upon request
- > UL or ETL Certified

Available: All DARRAN collections, excludes Grove

RJ45 Knockout	
RJ45 (1)	\$55

