



Not So Square Office Price List

Effective April 1, 2024

Date Page
04.12.24

Modification
Updated Pricing

Description

Statement of Line
Features & Advantages..... 1
Finishes | Specifications 3
Edges | Pulls..... 4
Grommets | Grommet Reference..... 5
Ganging | Height Reference 6
Metal Legs..... 8
Modesty Reference | Grain Direction 9
Drawer Dimensions | FILING Reference..... 10
Double Pedestal Desk..... 11
Table Desk..... 12
Freestanding Desks 13
Single Pedestal Desk 14
Conference Desk..... 15
Runoff Desk 17
Returns 18
Bridges 21
Freestanding Credenzas 22
Workstation Credenzas 23
Bench Cabinets 30
Pedestals..... 31
Single Height Freestanding Overheads 32
Double Height Freestanding Overheads..... 35
Overhead Accessories..... 37
Single Height Wall Hung Overheads 41
Double Height Wall Hung Overheads..... 44
Wall Hung Accessories..... 47
Wall Hung Overheads..... 52
Overhead Bookcases..... 54
Vertical Half Towers..... 55
Vertical Full Towers 58
Bookcases..... 60
Options 61
Power & Data..... 74

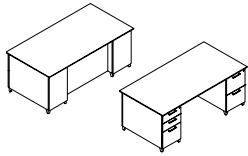

Page 10
Freestanding Desks
Breakfront - Full Pedestal With
Modesty Panel

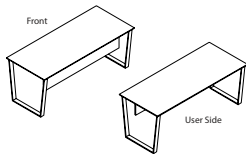

Page 11
Freestanding Desks
Table Desk With Sleigh Base

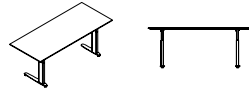

Page 12
Freestanding Desks
Adjustable Desk / Motorized

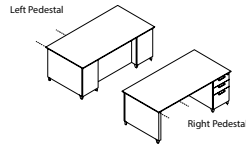

Page 13
Freestanding Workstation Desks
Breakfront Single Pedestal

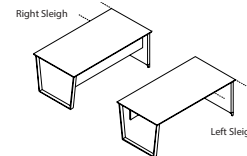

Page 14
Conference Workstation Desks
Rectangle Top With Sleigh Base

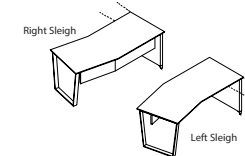

Page 15
Conference Workstation Desks
Angular Top With Sleigh Base

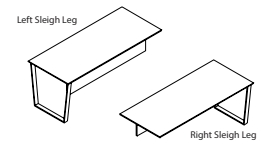

Page 16
Runoff Conference Workstation
Desks
Rectangle Runoff Desk With
Sleigh Base

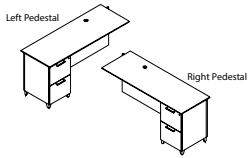

Page 17
"L" Workstation Returns
File/File

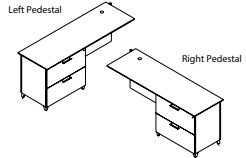

Page 18
"L" Workstation Returns
Lateral File

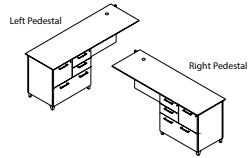

Page 19
"L" Workstation Returns
Multi-File

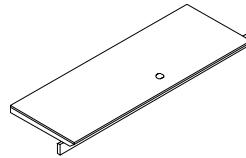

Page 20
Workstation Bridges
Open Back Bridge

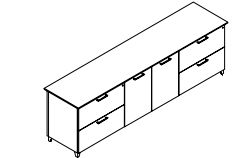

Page 21
Freestanding Lateral File Credenzas
Lateral File/Storage

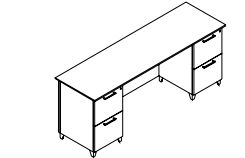

Page 22
File Credenzas
File/File/Kneespace

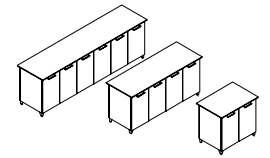

Page 23
Freestanding Storage Credenzas
Storage

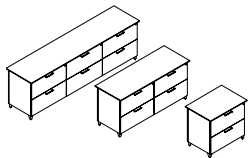

Page 24
Freestanding Lateral File Cre-
denzas
Horizontal Lateral File

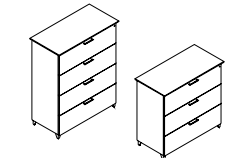

Page 25
Freestanding Lateral File Cre-
denzas
Vertical Lateral File

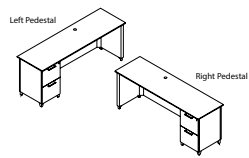

Page 26
Workstation Credenzas
File/File

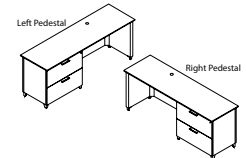

Page 27
Workstation Credenzas
Lateral File

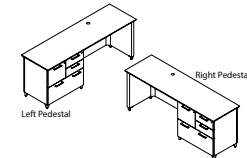

Page 28
Workstation Credenzas
Multi-File

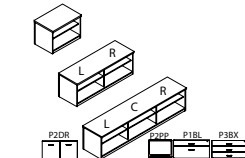

Page 29
Bench Cabinets
One / Two / Three Section
Storage

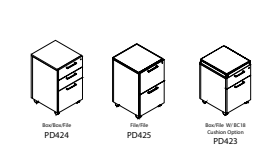

Page 30
Freestanding Mobile Pedestal
Mobile Pedestal - Under Surface
Storage

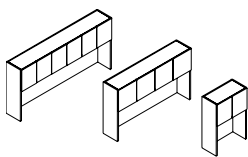

Page 31
Single Storage Overhead
Consoles
Panel Door - 6/4/2 Door

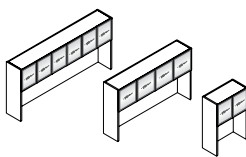

Page 32
Single Storage Overhead
Consoles
Silverluma Frame Doors / 6/4/2
Door

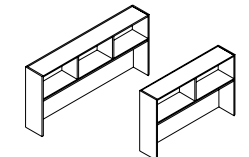

Page 33
Single Storage Overhead
Consoles
Open Storage Console

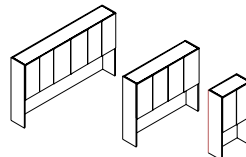

Page 34
Double Height Overhead
Consoles
Panel Door

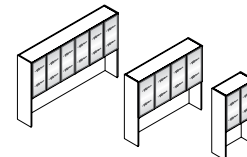

Page 35
Double Height Overhead
Consoles
Silverluma Frame 6/4/2 Doors

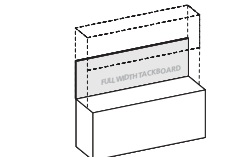

Page 36
Overhead Tackboards

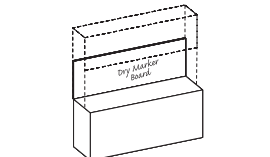

Page 37
Overhead Dry Marker Boards

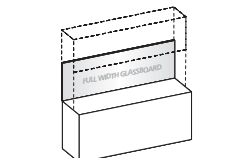

Page 38
Overhead Glassboards

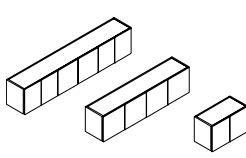

Page 39
Single Height Wall Hung Over-
heads
Panel Doors

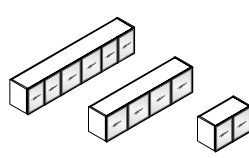

Page 40
Single Height Wall Hung Over-
heads
Silverluma Frame / Doors

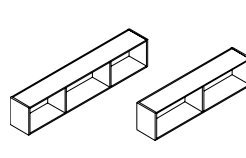

Page 41
Single Height Wall Hung Over-
heads
Open Storage Cabinet

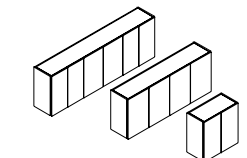

Page 42
Double Height Wall Hung
Overheads
Panel Doors

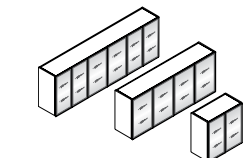

Page 43
Double Height Wall Hung
Overheads
Silverluma Frame / Doors

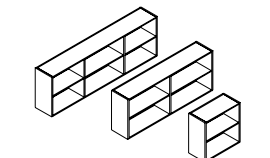

Page 44
Double Height Wall Hung
Overheads
Open Storage Cabinet

Statement of Line

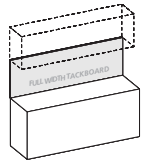

Page 45
Wall Hung Tackboards

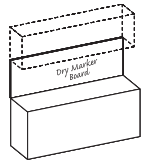

Page 46
Wall Hung Dry Marker Boards

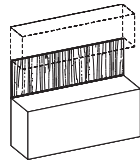

Page 47
Wall Hung Veneer Panels

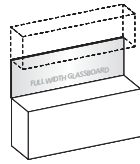

Page 48
Wall Hung Glassboards

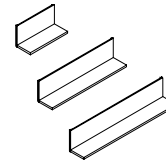

Page 49
Single Height Wall Hung Overheads
Open Endless Shelf Single Height

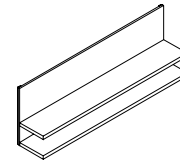

Page 50
Double Height Wall Hung Overheads
Open Endless Shelf Double Height

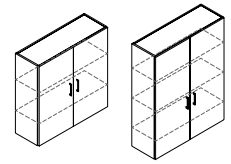

Page 51
Overhead Bookcases
Panel Doors / Storage

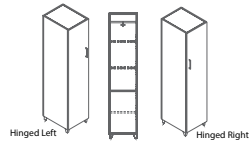

Page 52
Freestanding Half Towers
Wardrobe / Storage

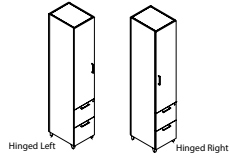

Page 53
Freestanding Half Towers
Storage / File

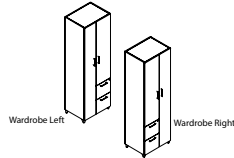

Page 54
Freestanding Towers
Storage / File- Mini-Wardrobe

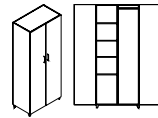

Page 55
Freestanding Towers
Wardrobe / Storage Full Tower

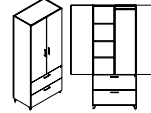

Page 56
Freestanding Towers
Storage / File Full Tower

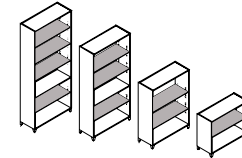

Page 57
Open Bookcases
Freestanding

Veneer

DARRAN only uses HPVA AA Grade Flat Cut Cherry, Maple, and Walnut Veneers and AA Grade Quartered Oak Veneers. Not SO square is also available in double cut reconstituted walnut and oak patterns made from rapidly renewable wood veneer providing a repeatable consistent straight grain pattern. All veneers are selected and matched for balance and consistency.

Veneer Tops

Not SO square veneer tops feature a 45-pound density substrate with balanced 3-ply construction. Tops are 1-1/8" thick on MDF core comprised of 100% recycled and recovered wood fibers. All veneer tops are slipmatched and feature a 3mm external solid hardwood band or profile edge.

Laminate Tops

Not SO square high-pressure laminate tops feature a 45-pound density substrate with balanced 3-ply construction. Tops are 1-1/8" thick on MDF core comprised of 100% recycled and recovered wood fibers. All high pressure laminate tops are available with a profile edge, laminate self-edge or 2mm PVC edge band. Laminates in wood grain patterns feature a fine grain texture that features the polish and luxe of a real wood veneer with a subtle narrow grain structure.

TFL tops

Thermally Fused Laminate tops feature a 45-pound density substrate with balanced 3-ply construction. Tops are 1-1/8" thick on MDF core that is comprised of 100% recycled and recovered wood fibers. All Thermally Fused Laminate tops are available with a 2mm flat PVC band. Laminates in wood grain patterns feature Timberline Texture providing the grain pattern of wood.

Cleaning wood & laminate

In addition to regular dusting, give your furniture an occasional cleaning in accordance with our cleaning instructions. DARRAN wood and laminate products can be cleaned with a soft cloth and a mild soap and water mixture. Use approximately 32 oz of water mixed with one tablespoon of dish soap, always wiping with the grain. Dry with a soft cloth, going with the grain, to avoid spotting or streaking.

Wood products should be waxed periodically using a non-wax liquid; please do not use any waxy polish or cleaner. Interior of drawers may also be cleaned with mild soap and water mixture, or any household cleaner that is not petroleum or thinner-based.

Chassis & pedestal

Chassis components are 3/4" thick core of particle board or MDF rated EPP/SCS/CARB-II material with 3-ply balanced construction. Pedestal and Cabinets feature dowel construction reinforced with steel bracket plates, wood cleats, screws and glue. All units are standard with 1" adjustable glides that allow for leveling of units that are secured in

Not so square features & advantages

solid wood glide blocks to prevent tearout.

Overhead cabinet construction Freestanding & wall mount

Freestanding Overhead storage cabinets are constructed of 1" and 3/4" thick core of particle board or MDF rated EPP/SCS/CARB-II material with 3-ply balanced construction. Panels are attached with cam fasteners in conjunction with dowels securely adhered with PVAc glue. All surface mount cabinets connect to work surface with anti-slip tape. Wall mount cabinets are mounted to the wall with steel "z" bracket attachment method using 5mm euro screws to attach to the back of the cabinet. All units ship with a steel "z" bracket. This bracket is mounted to the wall by field installers. Installers are responsible for selecting and supplying appropriate fasteners for wall conditions.

Bookcase Construction

All chassis (sides, back, top and bottom panels) are constructed with 3/4" thick core of particle board or MDF rated EPP/SCS/CARB-II material with 3-ply balanced construction. Panels are attached with cam-lock fasteners in conjunction with dowels securely adhered with glue. Shelves on all units are 3/4" thick balance 3 ply panels. Optional heavy duty shelves are 1" thick lumber core balanced 5 ply construction.

Tackboards

Wall mount tackboards are constructed of .75" thick fiberboard. The fabric is precisely aligned and fitted to the tackboard with a sock on cover. Overhead storage tackboards are constructed of .75" thick fiberboard. The fabric is precisely aligned and fitted to the tackboard and adhered to the rigid hardboard with staples. Wall mount cabinets are mounted to the wall with steel "z" bracket attachment method using 5mm euro screws to attach to the back of the cabinet. All units ship with a steel "z" bracket. This bracket is mounted to the wall by field installers. Installers are responsible for selecting and supplying appropriate fasteners for wall conditions.

Adjustable glides

Glides provide 1" of vertical leveling adjustment. Glide bottom is durable metal. Glides are secured in solid wood blocks that are screwed and glued for durability.

Drawers

All drawers are constructed with mitre joint/dowel construction in a natural maple finish with four sides and a bottom, which are attached to a drawer front with screws for easy removal. Drawer fronts are vertically matched in balanced sets. Pencil trays are standard in all box drawers. Drawers are constructed of 1/2" thick wood grained wrapped 5 sided miter-folded construction with 1/4" thick hardboard bottoms reinforced for heavy weight capacity. Drawers have been tested and pass BIFMA 50,000 cycle test. All drawers are guaranteed lifetime with free replacement warranty.

Optional wood drawers

Optional hardwood veneer plywood drawers feature banded top and bottom edges for smoothness. Drawers are dowel joint construction with a UV cured finish over maple veneers, plus a lifetime free replacement guarantee.

Optional Wood Drawer (Any Size) – Option Code P33...\$45 List Price Per Drawer

Drawer fronts

Drawer fronts are vertically matched in balanced sets. Doors feature vertical veneer bookmatched horizontally in sets of 2 / 4 and 6 doors. All drawers and doors have traditional scallop profile edge shape. All tower fronts matched in vertical sets.

Suspensions

All caseloads utilize cold rolled steel zinc plated high-grade drawer suspensions. All suspensions are warranted for the lifetime of the product. Box and File drawers are full extension, featuring steel ball bearings for a smoother quieter range of motion and are rated 100lbs. Lateral file drawers are a progressive action full extension suspension and is rated at 150lbs. Veneer and High Pressure laminate caseloads feature soft close suspension. Thermally Fused Laminate caseloads feature standard suspensions. Lateral files include anti tip mechanism that allow only one drawer to be opened at a time.

Hinges

Units with doors include 95 degree swing hinges.

Filing

Not SO square features a highly durable black plastic extrusion that is securely fastened into a route on top of the drawer to support hanging files. An adjustable crossbar is provided for all file drawers that enables legal/letter filing front to back or side-to-side based on the drawer size..

Locks

Locks are Standard on all drawers below the worksurface. Random lock cores are installed at the factory. Some units may be shipped with the same key number. Locks are Silver, Black or Bronze and match pull finish unless otherwise specified.

DARRAN will also send lock cores separately to the dealer at your request. These units will be send with an empty lock core and the Dealer will receive a shipment of the requested lock core/keys.

Keying

Keying is available either factory or field installed. Factory installed keying is random.

Wire management

Wire management capabilities include standard and optional worksurface grommets. Specify W-1 under surface wire channels for organization and management of all communication wires and cords. Horizontal J-Channel wire management (Sku: W-1) is sold separately to conceal wire under worksurfaces.

Grommets

Metal grommets are provided to match the drawer pull selection. Grommet is available in black, silver or white. Must specify standard or non-standard location. Black plastic grommets are available as an option for vertical applications.

Powerports

A large selection of power pods are available and handle power, data, docking stations and communication. See options section for selection.

LED tasklights

LED task lighting provides high efficiency, low energy lighting with a long life. Surface mounted light is encased in silver aluminum channel with milk lense and rounded end caps. Lights are field installed. Product specifications listed below:

- Diffuser creates a softer light and eliminates hot spots
- Touch dimmer switch
- Can be “daisy chained” up to 90W
- 4.6 watts per foot
- 120 LEDs per meter
- Certification: UL Listed
- 50,000 hour life span.

Color Temp is 4000K

PREMIUM VENEERS



WLO Lofty Oak



TBCO Baby's Cheek



WFO Fawn Cypress



WNO Natural Oak



TOBW Organic Brown



TSTV Studio Teak



TSLV Skyline Walnut



TBSW Brown Sugar



WMO Mocha Oak

HIGH PRESSURE LAMINATES



GWL Designer White

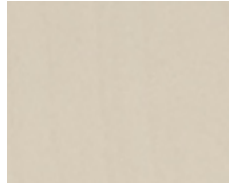

GAM Alabaster Maple



GNA Narvik Ash



GCM Clear Maple



LW02 Fawn Cypress



LW01 Neo Walnut



TSTV Studio Teak



TSLV Skyline Walnut



GHC Honey Cherry



GAC Amber Cherry



GNW Natural Walnut



GEW Executive Walnut



GIC Crimson Cherry

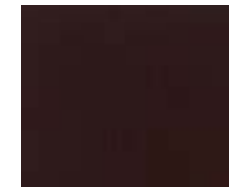

WOC KoKo Cherry



WEC Ebony Cherry

NOTE: Fenix Laminates available as top options for additional upcharge.
Contact Customer Service for quote

Finish

Welltech Finish delivers a superior furniture coating with exceptional performance that can withstand stringent cleaning agents and possesses unparalleled durability, allowing DARRAN to provide lasting, sustainable products to our customers.



TFL LAMINATE

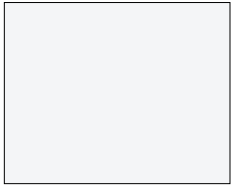

GWL Designer White



WAF Narvik Ash



WWW Weathered Walnut



TSTV Studio Teak



WGW Gunstock Walnut



TSLV Skyline Walnut



WAC Amber Cherry



WOC KoKo Cherry



WEC Ebony Cherry

POWDERCOATS

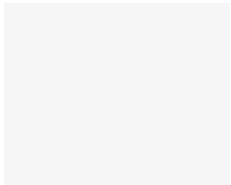

MFW White



MFCB Chrome

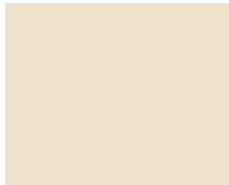

MFOS Oyster

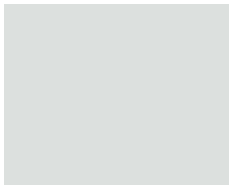

MFG Grey

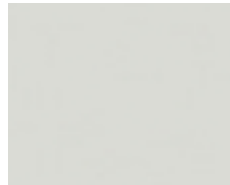

MFGW Gray White



MFS Silver



MFCB Grey Beige



MFGM Gold



MFSB Satin Bronze



MFCG Graphite Gray



MFNA Navy



MFMB Matte Black

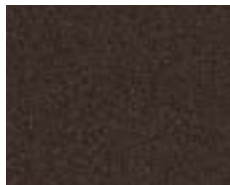

MFDB Dark Bronze

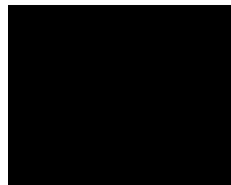

MFB Black

Finish

Welltech Finish delivers a superior furniture coating with exceptional performance that can withstand stringent cleaning agents and possesses unparalleled durability, allowing DARRAN to provide lasting, sustainable products to our customers.



PAINTS (On Maple Veneer)



* Pure White (PM21)



* Boucle White (PM13)



Designer White (WWP)



Skyline Steel (PSS-SW 1015)



* Warm Gray (PM14)



* Golden Sand (PM17)



Designer White (WWP)



* Flagstone (PM11)



* Gold Umber (PM15)



* Redwood (PM19)



* London Gray (PM16)



Cyberspace (PCS-SW 7076)



* Maritime (PM23)



* Moonless Night (PM20)

* Contrasting Tops and Chassis are available for additional charge.
Contact Customer Service for Quote

Finish

Welltech Finish delivers a superior furniture coating with exceptional performance that can withstand stringent cleaning agents and possesses unparalleled durability, allowing DARRAN to provide lasting, sustainable products to our customers.



Standard profile
NSS Edge

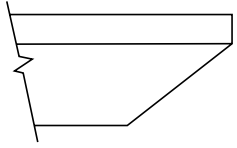

NSS Bevel
"W" 3mm Solid Hardwood Band
"G" PVC Edge on Wood Chassis



NSS Bevel
"G" 2mm PVC Edge with Black Foil
on Melamine Chassis

Pulls/knobs
Factory Installed

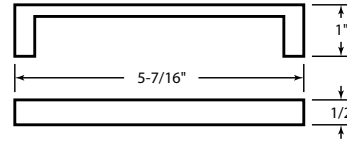

PL-115 Matte Black
PL-116 Matte Nickel

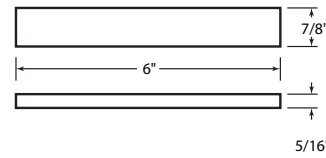

PL-210 Anodized Aluminum



Bridge/return hookup edge

Hookup tops feature reverse cope shaping for custom flush surface appearance and improved use.

DARRAN®

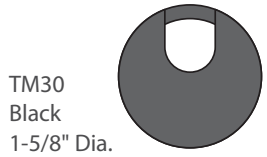

TM30
Black
1-5/8" Dia.

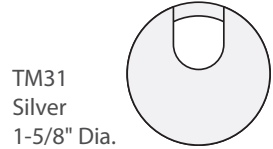

TM31
Silver
1-5/8" Dia.



TM34
White
1-5/8" Dia.

Optional grommets

Factory Installed

Grommets (Standard Location)

Specify Color and Left/Right/Center - \$50 ea.

- Black: TM30-R (Right), TM30-L (Left), TM30-C (Center)
- Silver: TM31-R (Right), TM31-L (Left), TM31-C (Center)
- White: TM34-R (Right), TM34-L (Left), TM34-C (Center)

Grommets (Non-Standard Location)

Provide drawing w/ Grommet Location and Specify Color - \$95 ea.

- Black: TM30-NS
- Silver: TM31-NS
- White: TM34-NS

Not So Square Grommets | Grommet Reference

TM50
Black
1-5/8" Dia.



Grommets (vertical surface)

Standard Location - \$50 ea.

- Black Plastic Vertical Surface: TM50-C (Bottom Center)

Non-Standard Location - \$95 ea.

- Black Plastic Vertical Surface: TM50-NS

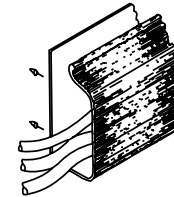

W1

Horizontal J-channel

Horizontal J-Channel wire management (Sku: W-1) is sold separately to conceal wire under worksurfaces.

Standard grommet location reference



Desk
Specify Right or Left Grommet

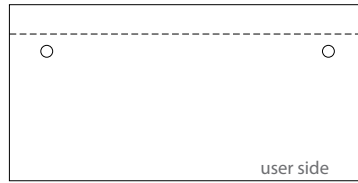

6" Overhang Desk
Specify Right or Left Grommet



Bridge
Center Grommet



Return (Left Pedestal Shown)
Right Pedestal - Left Grommet
Left Pedestal - Right Grommet



Workstation Credenza
Center Kneespace Grommet

Ganging – flush cut modification

30”H Casework Worksurface & Base Ganging Modifications

To gang two casework units, each unit end to be ganged must be flush cut modified for gapless surfaces and cabinet chassis.

Order Option:

- FC-B: Flush Unit Both Sides(Facing) for Ganging - \$100
- FC-L: Flush Unit Left (Facing) for Ganging - \$100
- FC-R: Flush Unit Right (Facing) for Ganging - \$100

Flush cut modification per unit includes all modifications to gang to one end or both ends when units are ganged. Modification includes tops, base and molding. Modification reduces width size approximately 1” per end.

Example:

NSS3121100W Two Drawer Lateral File (Left) Flush Cut Right – FC-R...\$100

NSS7221054 Kneespace Credenza (Right) Flush Cut Left – FC-L...\$100

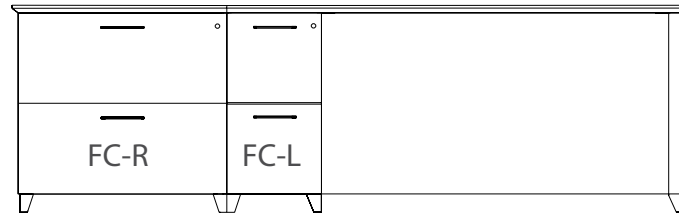

Height reference

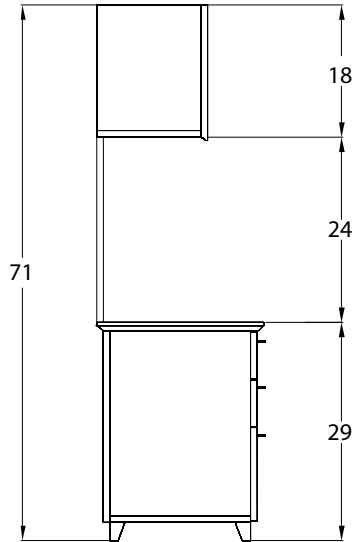

Typical Single Height Side Profile Wall Hung Overhead

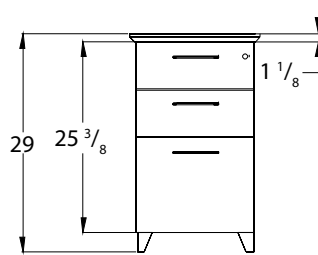

Pedestal Front Profile Box/Box/File

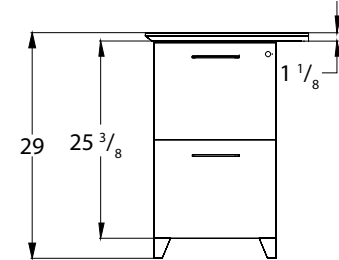

Pedestal Front Profile File/File

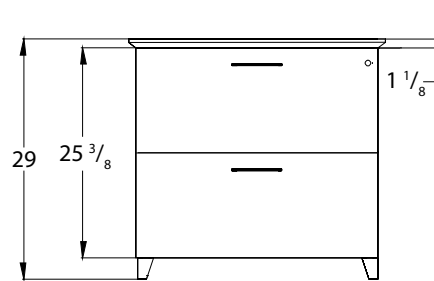

Pedestal Front Profile Lateral File

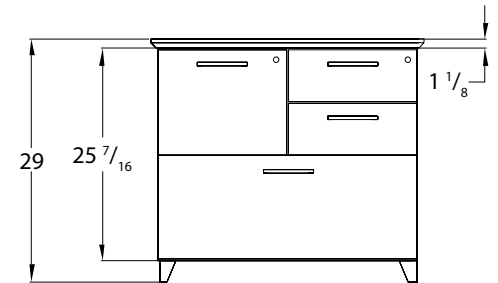

Pedestal Front Profile Multi-File

Credenzas, overheads and towers

Towers and overheads are standard flat top for easy ganging. No modification needed.

Credenza must be specified for flush cut ends when ganging to towers.

Credenza width matches overhead width when both credenza ends are flush cut.

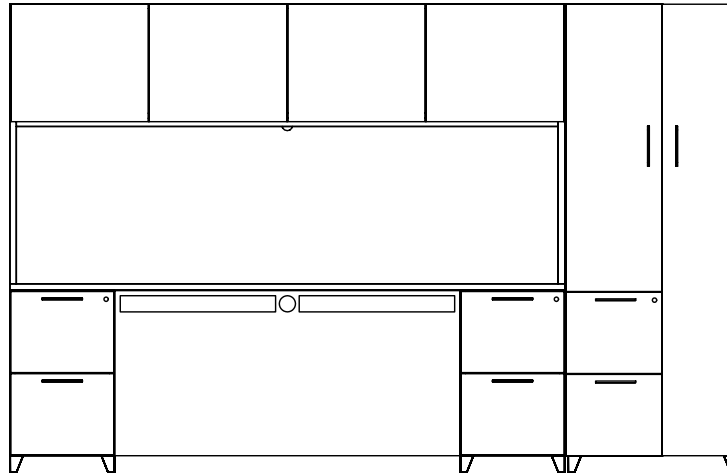

CABINET ANGULAR FOOT
Cast Angular Foot

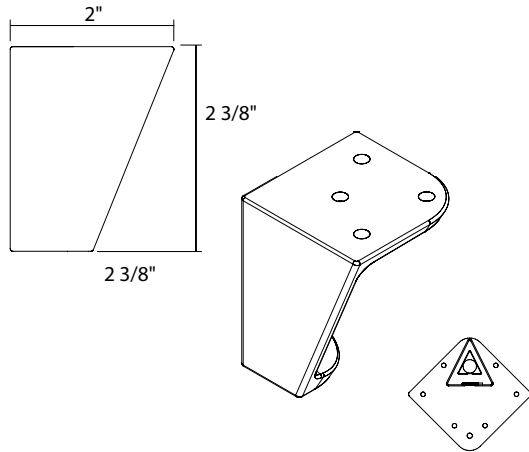

DESK ANGULAR POST

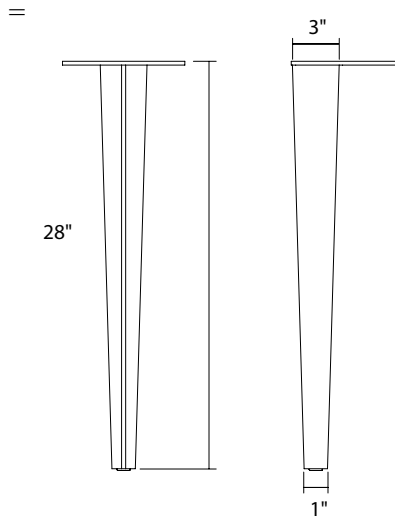

DESK ANGULAR SLEIGH BASE

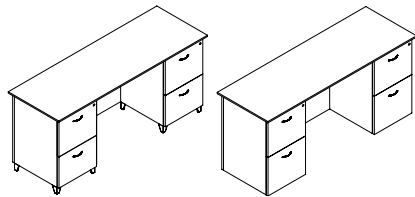
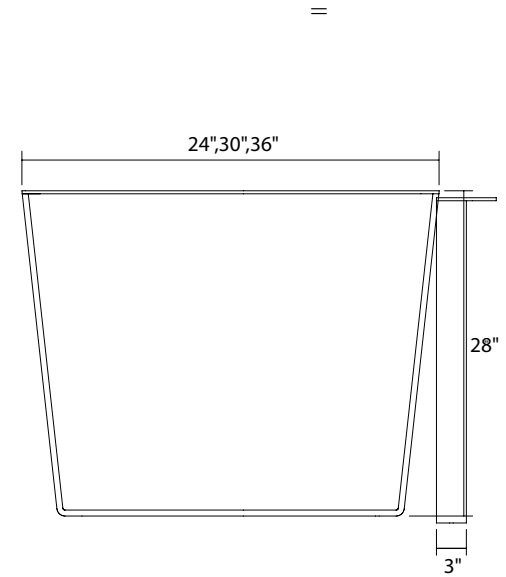

Option: Delete Feet/Extended Fronts

Standard metal feet can be deleted on any unit. Delete foot option extends chassis cabinets to floor. Drawer/Door fronts are extended to within 3/8" of full cabinet height when delete foot option is specified.

Delete Foot Chassis Modification Option:
D8. . .No Charge

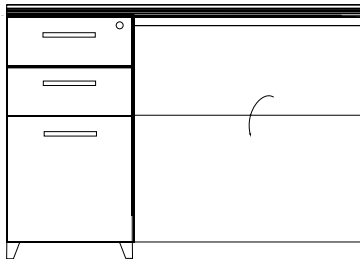

M34
Drop Door Tech Modesty

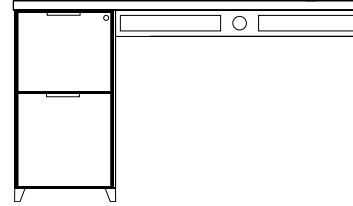

M51
Open Back Modesty with 4"
Wire Management Rail

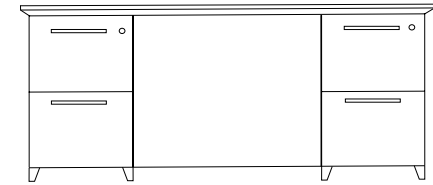

M37
Fixed Full Modesty

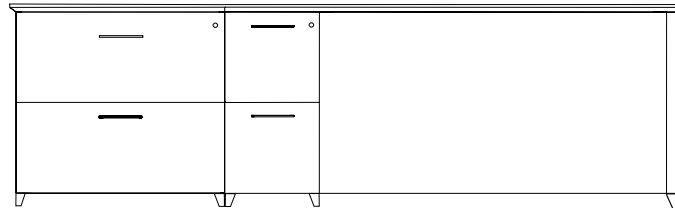

Grain direction

Veneer chassis parts are vertical grain. The backs of Thermally Fused Laminate overheads, wall hungs, wall hung shelves and flush chassis desks are horizontal grain. Bridges, returns, and credenza kneespace Thermally Fused Laminate backs over 60" are horizontal grain. Doors feature vertical veneer bookmatched horizontally in sets of 2, 4, and 6 doors. Tower fronts are matched in vertical sets.

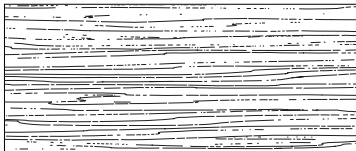

Desk

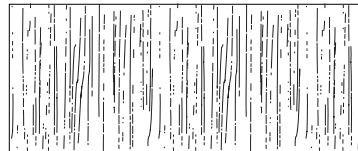

Runoff Desk
Grain Direction on TFL Units
Above 60" runs end to end

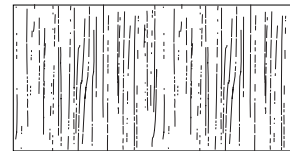

Bridge
Grain Direction on TFL Units
Above 60" runs end to end



Credenza

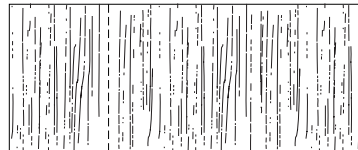

Return
Grain Direction on TFL Units
Above 60" runs end to end

NOT SO square office
Freestanding Desks
Breakfront - Full Pedestal With Modesty Panel

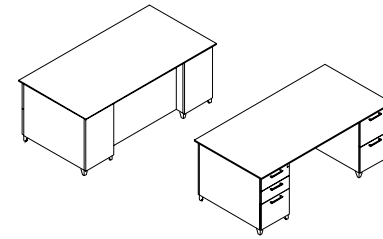

[Click here to view statement of line](#)

1 Select Model

w" x d" x h"	Weight
84 x 36 x 29	350
72 x 36 x 29	315
72 x 30 x 29	295
66 x 30 x 29	270

Standard Veneer Top Standard Veneer Chassis		Premium Veneer Top Premium Veneer Chassis		High Pressure Laminate Top Veneer Chassis		High Pressure Laminate Top Thermally Fused Laminate Chassis	
NSS8436DD000W	5214	NSS8436DD000P	5736	NSS8436DD000G	5214	NSS8436DD000M	3882
NSS7236DD000W	4846	NSS7236DD000P	5332	NSS7236DD000G	4846	NSS7236DD000M	3744
NSS7230DD000W	4625	NSS7230DD000P	5087	NSS7230DD000G	4625	NSS7230DD000M	3693
NSS6630DD000W	4581	NSS6630DD000P	5041	NSS6630DD000G	4581	NSS6630DD000M	3612

Product Features

- 6" recessed modesty
- Breakfront modesty
- Locking drawers
- Soft close suspension drawer(s)
- Standard Silver Feet (optional White, Black)

Options

- Accessories**
- K28: Articulating Keyboard w/ Mouse - \$390
 - K31: Center Drawer w/out Pull - \$205
- Chassis**
- MODCX: Modify breakfront chassis to flush front chassis - n/c
- Drawer**
- P6: Modify File/File to Box/Box/File - \$55 per pedestal
 - P33: Wood Drawer Upgrade - \$45 per drawer
 - WPD3061: Designer White - \$80 per pedestal
- Feet**
- D8: Delete feet (extend fronts to floor) - n/c
- Grommets (Standard Location)**
- Specify Color and Location Right/Left - \$50 ea.
- Black: TM30-R (Right), TM30-L (Left)
 - Silver: TM31-R (Right), TM31-L (Left)
 - White: TM34-R (Right), TM34-L (Left)
- Grommets (Non-Standard Location)**
- Provide drawing w/ Grommet Location and Specify Color - \$95 ea.
- Black: TM30-NS
 - Silver: TM31-NS
 - White: TM34-NS
- Modesty**
- HM51: Half Modesty - \$205
 - HM39: SilverLuma frame/frost (Half Modesty) - \$340
- Premium Finish Option**
- Specify foot Metal Finish color - \$130 per unit. Contact customer service
 - MFB: Black, MFW: White, MFDB: Dark Bronze, MFGM: Matte Gold

2 Select Finish

[Click to view finishes](#)

WAC	WNW
WIC	WWP
WHC	WWW
WOC	WNF(Natural Oak on Flat Cut)
WEC	WSF(Salted Oak on Flat Cut)
WAM	WMF(Mocha Oak on Flat Cut)
WCM	WLF(Lofty Oak on Flat Cut)
WEW	
WGW	
WBW	
WSW	

TBCO
TBSW
TSTV
TSMV
TSLV
TOBW
WLO
WMO
WNO
WSO

GAC GSLV +10%
GIC GWL
GHC
GOC
GEC
GAM
GCM
GEW
GNW
GSTV +10%

GAC/MAC
GOC/MOC
GEC/MEC
GSTV/MTW
GSLV/MSW
GWL/MWL

3 Select Edge

[Click to view edges](#)



4 Select Hardware

[Click to view details](#)

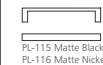
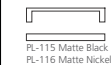

NOT SO square office

Freestanding Desks Table Desk With Sleigh Base

[Click here to view statement of line](#)

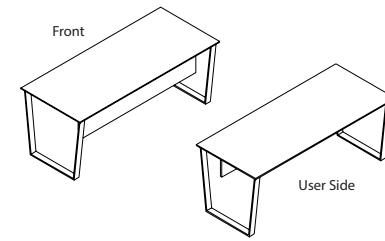

1 Select Model

w" x d" x h"	Weight
72 x 36 x 29	150
72 x 30 x 29	135
66 x 30 x 29	125

Standard Veneer Top Standard Veneer Chassis		Premium Veneer Top Premium Veneer Chassis		High Pressure Laminate Top Veneer Chassis		High Pressure Laminate Top Thermally Fused Laminate Chassis	
NSS7236DT107W	4512	NSS7236DT107P	4962	NSS7236DT107G	4512	NSS7236DT107M	2967
NSS7230DT107W	4317	NSS7230DT107P	4750	NSS7230DT107G	4317	NSS7230DT107M	2866
NSS6630DT107W	4262	NSS6630DT107P	4688	NSS6630DT107G	4262	NSS6630DT107M	2762

Product Features

- Half modesty panel standard
- Freestanding use
- Standard table desk sleigh base is silver Metal Finish (optional white or black)

Options

Accessories

- K28: Articulating Keyboard w/ Mouse - \$390
- K31: Center Drawer w/out Pull - \$205
- W17: Wire Mgmt. Cover matches leg finish - \$80

Grommets (Standard Location)

Specify Color and Location Right/Left - \$50 ea.

- Black: TM30-R (Right), TM30-L (Left)
- Silver: TM31-R (Right), TM31-L (Left)
- White: TM34-R (Right), TM34-L (Left)

Grommets (Non-Standard Location)

Provide drawing w/ Grommet Location and Specify Color - \$95 ea.

- Black: TM30-NS
- Silver: TM31-NS
- White: TM34-NS

Premium Finish Option

- Specify foot Metal Finish color - \$160 per unit. Contact customer service
- MFB: Black, MFW: White

2 Select Finish

[Click to view finishes](#)

Metal Finish

MFS Silver. Additional Metal Finishes are available, options

WAC	WNW	TBCO	GAC	GSLV +10%	GAC/MAC
WIC	WWP	TBSW	GIC	GWL	GOC/MOC
WHC	WWW	TSTV	GHC		GEC/MEC
WOC	WNF(Natural Oak on Flat Cut)	TSMV	GOC		GSTV/MTW
WEC	WSF(Salted Oak on Flat Cut)	TSLV	GEC		GSLV/MSW
WAM	WCM	TOBW	GAM		GWL/MWL
WCM	WEW	WLO	GCM		
WEW	WGW	WMO	GEW		
WGW	WBW	WNO	GNW		
WBW	WSW	WSO	GSTV +10%		
WSW					

3 Select Edge

[Click to view edges](#)



4 Select Hardware

[Click to view details](#)

Hardware
N/A

Hardware
N/A

Hardware
N/A

Hardware
N/A

NOT SO square office

Freestanding Desks
Adjustable Desk / Motorized

[Click here to view statement of line](#)

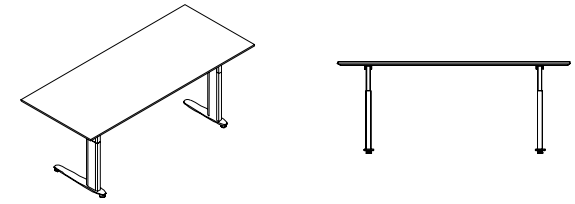

1 Select Model

w" x d" x h"	Weight
72 x 30 x 29-48	230
66 x 30 x 29-48	215
60 x 30 x 29-48	200

Standard Veneer Top Standard Veneer Chassis		Premium Veneer Top Premium Veneer Chassis		High Pressure Laminate Top Veneer Chassis		High Pressure Laminate Top Thermally Fused Laminate Chassis	
NSS7230DT090W	4709	NSS7230DT090P	5181	NSS7230DT090G	4709	NSS7230DT090M	3466
NSS6630DT090W	4683	NSS6630DT090P	5153	NSS6630DT090G	4683	NSS6630DT090M	3389
NSS6030DT090W	4654	NSS6030DT090P	5120	NSS6030DT090G	4654	NSS6030DT090M	3302

Product Features

- Adjustable height base - silver, white or black
- Electronic mechanism with programmable lift
- Unit includes 72" power cord

Notes

- Shipped KD

Options

Accessories

- K28: Articulating Keyboard w/ Mouse - \$390
- K31: Center Drawer w/out Pull - \$205
- W18: Coil Cable Manager - \$160

Grommets (Standard Location)

Specify Color and Location Right/Left - \$50 ea.

- Black: TM30-R (Right), TM30-L (Left)
- Silver: TM31-R (Right), TM31-L (Left)
- White: TM34-R (Right), TM34-L (Left)

Grommets (Non-Standard Location)

Provide drawing w/ Grommet Location and Specify Color - \$95 ea.

- Black: TM30-NS
- Silver: TM31-NS
- White: TM34-NS

Modesty

- HM3: Veneer Half Modesty - \$260 (For "W" and "G")
- HM3M: Melamine Half Modesty - \$205 (For "M")

2 Select Finish

[Click to view finishes](#)

WAC	WNW
WIC	WWP
WHC	WWW
WOC	WNF(Natural Oak on Flat Cut)
WEC	WSF(Salted Oak on Flat Cut)
WAM	WMO
WCM	WML(Melamine on Flat Cut)
WEW	WMF(Mocha Oak on Flat Cut)
WGW	WLF(Lofty Oak on Flat Cut)
WBW	WSW

TBCO
TBSW
TSTV
TSMV
TSLV
TOBW
WLO
WMO
WNO
WSO

GAC
GIC
GHC
GOC
GEC
GAM
GCM
GEW
GNW
GSTV +10%

GAC/MAC
GOC/MOC
GEC/MEC
GSTV/MTW
GSLV/MSW
GWL/MWL

3 Select Edge

[Click to view edges](#)



NSS Bevel



NSS Bevel



NSS Bevel



NSS Bevel

4 Select Hardware

[Click to view details](#)

Hardware
N/A

Hardware
N/A

Hardware
N/A

Hardware
N/A

NOT SO square office

Freestanding Workstation Desks

Breakfront Single Pedestal

[Click here to view statement of line](#)

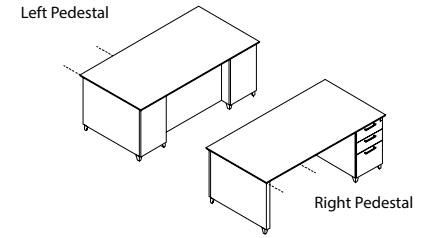

1 Select Model

w" x d" x h"	Weight
Left Pedestal	
72 x 36 x 29	300
72 x 30 x 29	270
66 x 30 x 29	260
Right Pedestal	
72 x 36 x 29	300
72 x 30 x 29	270
66 x 30 x 29	260

Standard Veneer Top Standard Veneer Chassis		Premium Veneer Top Premium Veneer Chassis		High Pressure Laminate Top Veneer Chassis		High Pressure Laminate Top Thermally Fused Laminate Chassis	
NSS7236DS009W	4733	NSS7236DS009P	5207	NSS7236DS009G	4733	NSS7236DS009M	3152
NSS7230DS009W	4520	NSS7230DS009P	4972	NSS7230DS009G	4520	NSS7230DS009M	3074
NSS6630DS009W	4481	NSS6630DS009P	4931	NSS6630DS009G	4481	NSS6630DS009M	3016
NSS7236DS010W	4733	NSS7236DS010P	5207	NSS7236DS010G	4733	NSS7236DS010M	3152
NSS7230DS010W	4520	NSS7230DS010P	4972	NSS7230DS010G	4520	NSS7230DS010M	3074
NSS6630DS010W	4481	NSS6630DS010P	4931	NSS6630DS010G	4481	NSS6630DS010M	3016

Product Features

- 6" recessed modesty
- Full extension drawers - locking
- Soft close suspension drawer(s)
- Standard Silver Feet (optional White, Black)

Options

- Accessories**
- K28: Articulating Keyboard w/ Mouse - \$390
 - K31: Center Drawer - \$205
- Chassis**
- MODCX-1: Modify breakfront chassis to flush front chassis w/ 6" overhang top - n/c
- Drawer**
- P33: Wood Drawer Upgrade - \$45 per drawer
 - WPD3061: Designer White - \$80 per pedestal
- Feet**
- D8: Delete feet (extend fronts to floor) - n/c
- Grommets (Standard Location)**
- Specify Color and Location Right/Left - \$50 ea.
- Black: TM30-R (Right), TM30-L (Left)
 - Silver: TM31-R (Right), TM31-L (Left)
 - White: TM34-R (Right), TM34-L (Left)
- Grommets (Non-Standard Location)**
- Provide drawing w/ Grommet Location and Specify Color - \$95 ea.
- Black: TM30-NS
 - Silver: TM31-NS
 - White: TM34-NS
- Modesty**
- HM39: SilverLuma frame/frost (Half Modesty) - \$340
 - HM51: Half Modesty - \$205
- Premium Finish Option**
- Specify foot Metal Finish color - \$160 per unit. Contact customer service
 - MFB: Black, MFW: White, MFDB: Dark Bronze, MFGM: Matte Gold

2 Select Finish

[Click to view finishes](#)

Metal Finish
MFS Silver. Additional Metal Finishes are available, options

WAC	WNW
WIC	WWP
WHC	WWW
WOC	WNF(Natural Oak on Flat Cut)
WEC	WSF(Salted Oak on Flat Cut)
WAM	WSM(Mocha Oak on Flat Cut)
WCM	WLF(Lofty Oak on Flat Cut)
WEW	WLO
WGW	WMO
WBW	WNO
WSW	WSO

TBCO
TBSW
TSTV
TSMV
TSLV
TOBW
WLO
WMO
WNO
WSO

GAC
GIC
GHC
GOC
GEC
GAM
GCM
GEW
GNW
GSTV +10%

GSLV +10%
GWL

GAC/MAC
GOC/MOC
GEC/MEC
GSTV/MTW
GSLV/MSW
GWL/MWL

3 Select Edge

[Click to view edges](#)



4 Select Hardware

[Click to view details](#)

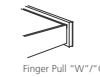
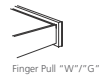
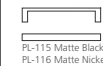
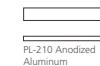
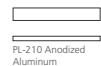

NOT SO square office

Conference Workstation Desks

Rectangle Top With Sleigh Base

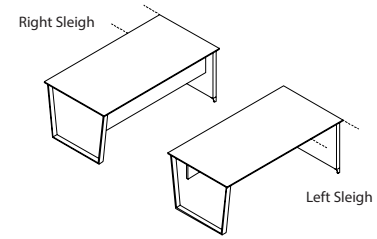

[Click here to view statement of line](#)

1 Select Model

Weight	w" x d" x h"
	Right Sleigh Leg
165	72 x 36 x 29
145	72 x 30 x 29
125	66 x 30 x 29
115	60 x 24 x 29
105	54 x 24 x 29
	Left Sleigh Leg
165	72 x 36 x 29
145	72 x 30 x 29
125	66 x 30 x 29
115	60 x 24 x 29
105	54 x 24 x 29

	Standard Veneer Top Standard Veneer Chassis		Premium Veneer Top Premium Veneer Chassis		High Pressure Laminate Top Veneer Chassis		High Pressure Laminate Top Thermally Fused Laminate Chassis	
	NSS7236DC766W	4311	NSS7236DC766P	4742	NSS7236DC766G	4311	NSS7236DC766M	2853
	NSS7230DC766W	4117	NSS7230DC766P	4530	NSS7230DC766G	4117	NSS7230DC766M	2692
	NSS6630DC766W	4076	NSS6630DC766P	4483	NSS6630DC766G	4076	NSS6630DC766M	2607
	NSS6024DC766W	2650	NSS6024DC766P	2916	NSS6024DC766G	2650	NSS6024DC766M	2548
	NSS5424DC766W	2620	NSS5424DC766P	2883	NSS5424DC766G	2620	NSS5424DC766M	2490
	NSS7236DC767W	4311	NSS7236DC767P	4742	NSS7236DC767G	4311	NSS7236DC767M	2853
	NSS7230DC767W	4117	NSS7230DC767P	4530	NSS7230DC767G	4117	NSS7230DC767M	2692
	NSS6630DC767W	4076	NSS6630DC767P	4483	NSS6630DC767G	4076	NSS6630DC767M	2607
	NSS6024DC767W	2650	NSS6024DC767P	2916	NSS6024DC767G	2650	NSS6024DC767M	2548
	NSS5424DC767W	2620	NSS5424DC767P	2883	NSS5424DC767G	2620	NSS5424DC767M	2490

2 Select Finish

Click to view finishes	WAC	WNW	TBCO	GAC	GSLV +10%	GAC/MAC
	WIC	WWP	TBSW	GIC	GWL	GOC/MOC
	WHC	WWW	TSTV	GHC		GEC/MEC
	WOC	WNF(Natural Oak on Flat Cut)	TSMV	GOC		GSTV/MTW
Metal Finish	WEC	WSF(Salted Oak on Flat Cut)	TSLV	GEC		GSLV/MSW
MFS Silver. Additional Metal Finishes are available, options	WAM	WMF(Mocha Oak on Flat Cut)	TOBW	GAM		GWL/MWL
	WCM	WLF(Lofty Oak on Flat Cut)	WLO	GCM		
	WEW		WMO	GEW		
	WGW		WNO	GNW		
	WBW		WSO	GSTV +10%		
	WSW					

	WAC	WNW	TBCO	GAC	GSLV +10%	GAC/MAC
	WIC	WWP	TBSW	GIC	GWL	GOC/MOC
	WHC	WWW	TSTV	GHC		GEC/MEC
	WOC	WNF(Natural Oak on Flat Cut)	TSMV	GOC		GSTV/MTW
	WEC	WSF(Salted Oak on Flat Cut)	TSLV	GEC		GSLV/MSW
	WAM	WMF(Mocha Oak on Flat Cut)	TOBW	GAM		GWL/MWL
	WCM	WLF(Lofty Oak on Flat Cut)	WLO	GCM		
	WEW		WMO	GEW		
	WGW		WNO	GNW		
	WBW		WSO	GSTV +10%		
	WSW					

3 Select Edge

Click to view edges



4 Select Hardware

Click to view details



Product Features

- 2" thick end panel
- Angular silver metal sleigh base
- Half modesty
- Standard Silver Feet and Base (optional White, Black)

Notes

- K28 and K31 will not fit on 24" deep units w/ half modesty

Options

Accessories

- K31: Center drawer - \$205
- K28: Articulating Keyboard w/ Mouse - \$390
- W17: Wire Mgmt. Cover, matches leg finish - \$80

Grommets (Standard Location)

- Specify Color - \$50 ea.
- Black: TM30-C (Center)
- Silver: TM31-C (Center)
- White: TM34-C (Center)

Grommets (Non-Standard Location)

Provide drawing w/ Grommet Location and Specify Color - \$95 ea.

- Black: TM30-NS
- Silver: TM31-NS
- White: TM34-NS

Modesty

- DM: Delete half modesty - n/c
- HM45: SilverLuma frame/frost insert (half modesty) - \$415

Premium Finish Option

- Specify foot Metal Finish color - \$160 per unit. Contact customer service
- MFB: Black, MFW: White

NOT SO square office

Conference Workstation Desks

Angular Top With Sleigh Base

[Click here to view statement of line](#)

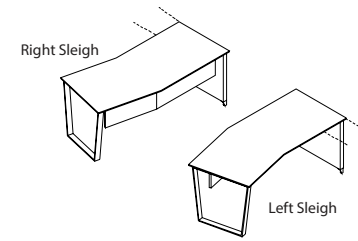

1 Select Model

w" x d" x h"
 Left Sleigh leg
 84 x 30/36 x 29
 72 x 30/36 x 29
 Right Sleigh leg
 84 x 30/36 x 29
 72 x 30/36 x 29

Weight	Standard Veneer Top Standard Veneer Chassis		Premium Veneer Top Premium Veneer Chassis		High Pressure Laminate Top Veneer Chassis		High Pressure Laminate Top Thermally Fused Laminate Chassis	
180	NSS8436DC785W	4805	NSS8436DC785P	5285	NSS8436DC785G	4805	NSS8436DC785M	3619
155	NSS7236DC785W	4383	NSS7236DC785P	4821	NSS7236DC785G	4383	NSS7236DC785M	3372
180	NSS8436DC784W	4805	NSS8436DC784P	5285	NSS8436DC784G	4805	NSS8436DC784M	3619
155	NSS7236DC784W	4383	NSS7236DC784P	4821	NSS7236DC784G	4383	NSS7236DC784M	3372

Product Features

- 2" thick end panel with metal legs
- Angled half modesty
- Standard Silver Feet and Base (optional White, Black)

Options

- Accessories
- K31: Center drawer - \$205
 - K28: Articulating Keyboard w/ Mouse - \$390
 - W17: Wire Mgmt. Cover, matches leg finish - \$80
- Grommets (Standard Location)
- Specify Color - \$50 ea.
- Black: TM30-C (Center)
 - Silver: TM31-C (Center)
 - White: TM34-C (Center)
- Grommets (Non-Standard Location)
- Provide drawing w/ Grommet Location and Specify Color - \$95 ea.
- Black: TM30-NS
 - Silver: TM31-NS
 - White: TM34-NS
- Modesty
- DM: Delete half modesty - n/c
- Premium Finish Option
- Specify foot Metal Finish color - \$160 per unit. Contact customer service
 - MFB: Black, MFW: White

2 Select Finish

[Click to view finishes](#)

Metal Finish
 MFS Silver. Additional
 Metal Finishes are
 available, options

WAC	WNW
WIC	WWP
WHC	WWW
WOC	WNF(Natural Oak on Flat Cut)
WEC	WSF(Salted Oak on Flat Cut)
WAM	WSF(Salted Oak on Flat Cut)
WCM	WMF(Mocha Oak on Flat Cut)
WEW	WMF(Mocha Oak on Flat Cut)
WGW	WLF(Lofty Oak on Flat Cut)
WBW	WLF(Lofty Oak on Flat Cut)
WSW	WLF(Lofty Oak on Flat Cut)

TBCO
 TBSW
 TSTV
 TSMV
 TSLV
 TOBW
 WLO
 WMO
 WNO
 WSO

GAC
 GIC
 GHC
 GOC
 GEC
 GAM
 GCM
 GEW
 GNW
 GSTV +10%

GAC/MAC
 GOC/MOC
 GEC/MEC
 GSTV/MTW
 GSLV/MSW
 GWL/MWL

3 Select Edge

[Click to view edges](#)



NSS Bevel



NSS Bevel



NSS Bevel



NSS Bevel

4 Select Hardware

[Click to view details](#)

Hardware
 N/A

Hardware
 N/A

Hardware
 N/A

Hardware
 N/A

NOT SO square office
Runoff Conference Workstation Desks
Rectangle Runoff Desk With Sleigh Base

[Click here to view statement of line](#)

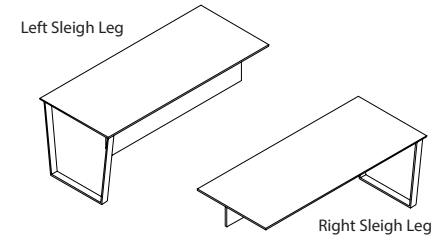

1 Select Model

w" x d" x h"
 Right Sleigh Leg
 72 x 30 x 29
 66 x 30 x 29
 60 x 30 x 29
 54 x 24 x 29
 Left Sleigh Leg
 72 x 30 x 29
 66 x 30 x 29
 60 x 30 x 29
 54 x 24 x 29

Weight	Standard Veneer Top Standard Veneer Chassis		Premium Veneer Top Premium Veneer Chassis		High Pressure Laminate Top Veneer Chassis		High Pressure Laminate Top Thermally Fused Laminate Chassis	
95	NSS7230DR770W	3697	NSS7230DR770P	4067	NSS7230DR770G	3697	NSS7230DR770M	2016
85	NSS6630DR770W	3668	NSS6630DR770P	4035	NSS6630DR770G	3668	NSS6630DR770M	1879
75	NSS6030DR770W	3638	NSS6030DR770P	4002	NSS6030DR770G	3638	NSS6030DR770M	1815
70	NSS5424DR770W	2337	NSS5424DR770P	2572	NSS5424DR770G	2337	NSS5424DR770M	1720
95	NSS7230DR771W	3697	NSS7230DR771P	4067	NSS7230DR771G	3697	NSS7230DR771M	2016
85	NSS6630DR771W	3668	NSS6630DR771P	4035	NSS6630DR771G	3668	NSS6630DR771M	1879
75	NSS6030DR771W	3638	NSS6030DR771P	4002	NSS6030DR771G	3638	NSS6030DR771M	1815
70	NSS5424DR771W	2337	NSS5424DR771P	2572	NSS5424DR771G	2337	NSS5424DR771M	1720

Product Features

- Half modesty standard
- Standard Silver Base (optional White, Black)

Notes

- When Specifying Runoff Desk w/ Bench Credenzas, You Must: Specify Runoff Desk Bench Support.
- K28 and K31 will not fit on 24" deep units w/ half modesty
- Hooks to freestanding unit

Options

- Accessories
- K28: Articulating Keyboard w/ Mouse - \$390
 - K31: Center Drawer - \$205
 - W17: Wire Mgmt. Cover, matches leg finish - \$80
- Bench Support
- 23BRL30: 30" Bench Support - "W" and "G" \$195 - "M" \$130
 - 23BRL24: 24" Bench Support - "W" and "G" \$155 - "M" \$115
- Grommets (Standard Location)
- Specify Color - \$50 ea.
- Black: TM30-C (Center)
 - Silver: TM31-C (Center)
 - White: TM34-C (Center)
- Grommets (Non-Standard Location)
- Provide drawing w/ Grommet Location and Specify Color - \$95 ea.
- Black: TM30-NS
 - Silver: TM31-NS
 - White: TM34-NS
- Modesty
- DM: Delete Half Modesty - n/c
 - HM45: SilverLuma frame/frost insert (half modesty) - \$395
- Premium Finish Option
- Specify foot Metal Finish color - \$160 per unit. Contact customer service
 - MFB: Black, MFW: White, MFD: Dark Bronze, MFGM: Matte Gold

2 Select Finish

[Click to view finishes](#)

WAC	WNW
WIC	WWP
WHC	WWW
WOC	WNF(Natural Oak on Flat Cut)
WEC	WSF(Salted Oak on Flat Cut)
WAM	WSF(Salted Oak on Flat Cut)
WCM	WMF(Mocha Oak on Flat Cut)
WEW	WMF(Mocha Oak on Flat Cut)
WGW	WLF(Lofty Oak on Flat Cut)
WBW	WLF(Lofty Oak on Flat Cut)
WSW	WLF(Lofty Oak on Flat Cut)

TBCO	GAC	GSLV +10%
TBSW	GIC	GWL
TSTV	GHC	
TSMV	GOC	
TSLV	GEC	
TOBW	GAM	
WLO	GCM	
WMO	GEW	
WNO	GNW	
WSO	GSTV +10%	

GAC/MAC
GOC/MOC
GEC/MEC
GSTV/MTW
GSLV/MSW
GWL/MWL

3 Select Edge

[Click to view edges](#)



4 Select Hardware

[Click to view details](#)

Hardware
N/A

Hardware
N/A

Hardware
N/A

Hardware
N/A

NOT SO square office

"L" Workstation Returns

File/File

[Click here to view statement of line](#)

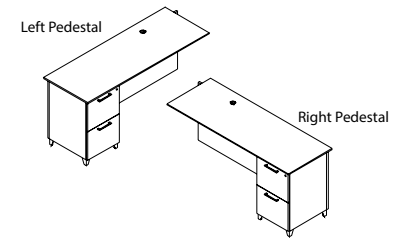

1 Select Model

w" x d" x h"	Weight
Left Pedestal	
60 x 22 x 29	160
54 x 22 x 29	145
48 x 22 x 29	135
42 x 22 x 29	125
Right Pedestal	
60 x 22 x 29	160
54 x 22 x 29	145
48 x 22 x 29	135
42 x 22 x 29	125

Standard Veneer Top Standard Veneer Chassis		Premium Veneer Top Premium Veneer Chassis		High Pressure Laminate Top Veneer Chassis		High Pressure Laminate Top Thermally Fused Laminate Chassis	
NSS6022RE195W	3673	NSS6022RE195P	4040	NSS6022RE195G	3673	NSS6022RE195M	2206
NSS5422RE195W	3651	NSS5422RE195P	4018	NSS5422RE195G	3651	NSS5422RE195M	2100
NSS4822RE195W	3514	NSS4822RE195P	3866	NSS4822RE195G	3514	NSS4822RE195M	2019
NSS4222RE195W	3467	NSS4222RE195P	3814	NSS4222RE195G	3467	NSS4222RE195M	1967
NSS6022RE196W	3673	NSS6022RE196P	4040	NSS6022RE196G	3673	NSS6022RE196M	2206
NSS5422RE196W	3651	NSS5422RE196P	4018	NSS5422RE196G	3651	NSS5422RE196M	2100
NSS4822RE196W	3514	NSS4822RE196P	3866	NSS4822RE196G	3514	NSS4822RE196M	2019
NSS4222RE196W	3467	NSS4222RE196P	3814	NSS4222RE196G	3467	NSS4222RE196M	1967

Product Features

- All drawers lock
- Standard full fixed modesty panel
- Standard metal grommet matches pull finish
- Standard silver feet (optional White, Black)
- Soft close suspension drawer(s)

Notes

- Laminate version "M" standard w/ open plan back
- Returns with Grommets in top will automatically have wire channel and outfeed holes in back.
- Unit not designed for open plan use. Select OPB for Open Plan application

Options

Accessories

- K28: Articulating Keyboard w/ Mouse - \$390

Drawer

- P6: Modify File/File to Box/Box/File - \$55 per pedestal
- P33: Wood Drawer Upgrade - \$45 per drawer
- P40W: extra Box/Box/File or File/File to Knee space - \$910
- P40M: extra Box/Box/File or File/File to Knee space - \$720
- WPD3061: Designer White - \$80 per pedestal

Feet

- D8: Delete feet (extend fronts to floor) - n/c

Flush Cut

- FC-L: Flush Unit Left (Facing) for Ganging - \$55
- FC-R: Flush Unit Right(Facing) for Ganging - \$55

Grommets (Non-Standard Location)

Provide drawing w/ Grommet Location and Specify Color - \$95 ea.

- Black: TM30-NS

- Silver: TM31-NS

- White: TM34-NS

Modesty

- M34T: Drop Door Tech Modesty - \$130
- M34TM: "M" Style Drop Door Tech Modesty - \$130
- M51: Open Back Modesty with Wire Mgmt Rail - Deduct \$95

Open Plan _ Finished Back

- OPB: "W" "G" Style - Modify Unit for Open Plan Application - \$295

Premium Finish Option

- Specify foot Metal Finish color - \$160 per unit. Contact customer service
- MFB: Black, MFW: White, MFD: Dark Bronze, MFGM: Matte Gold

2 Select Finish

[Click to view finishes](#)

Metal Finish

MFS Silver. Additional

Metal Finishes are available, options

WAC	WNW
WIC	WWP
WHC	WWW
WOC	WNF(Natural Oak on Flat Cut)
WEC	WSF(Salted Oak on Flat Cut)
WAM	WSF(Salted Oak on Flat Cut)
WCM	WMF(Mocha Oak on Flat Cut)
WEW	WLF(Lofty Oak on Flat Cut)
WGW	WLF(Lofty Oak on Flat Cut)
WBW	WLF(Lofty Oak on Flat Cut)
WSW	WLF(Lofty Oak on Flat Cut)

TBCO
TBSW
TSTV
TSMV
TSLV
TOBW
WLO
WMO
WNO
WSO

GAC
GIC
GHC
GOC
GEC
GAM
GCM
GEW
GNW
GSTV +10%

GAC/MAC
GOC/MOC
GEC/MEC
GSTV/MTW
GSLV/MSW
GWL/MWL

3 Select Edge

[Click to view edges](#)



NSS Bevel



NSS Bevel



NSS Bevel



NSS Bevel

4 Select Hardware

[Click to view details](#)



PL-115 Matte Black
PL-116 Matte Nickel

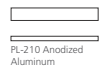

PL-210 Anodized Aluminum



PL-115 Matte Black
PL-116 Matte Nickel



PL-210 Anodized Aluminum



PL-115 Matte Black
PL-116 Matte Nickel

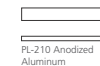

PL-210 Anodized Aluminum

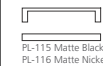

PL-115 Matte Black
PL-116 Matte Nickel



PL-210 Anodized Aluminum



PL-260 Anodized Aluminum
PL-261 White



Finger Pull "W"/"G"



PL-260 Anodized Aluminum
PL-261 White



Finger Pull "W"/"G"



PL-260 Anodized Aluminum
PL-261 White



Finger Pull "W"/"G"



PL-260 Anodized Aluminum
PL-261 White

NOT SO square office
"L" Workstation Returns
Lateral File

[Click here to view statement of line](#)

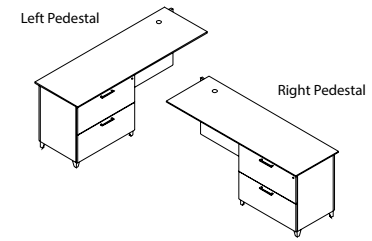

1 Select Model

w" x d" x h"	Weight
Left Pedestal	
72 x 22 x 29	200
66 x 22 x 29	190
60 x 22 x 29	180
54 x 22 x 29	170
48 x 22 x 29	165
Right Pedestal	
72 x 22 x 29	200
66 x 22 x 29	190
60 x 22 x 29	180
54 x 22 x 29	170
48 x 22 x 29	165

Standard Veneer Top Standard Veneer Chassis		Premium Veneer Top Premium Veneer Chassis		High Pressure Laminate Top Veneer Chassis		High Pressure Laminate Top Thermally Fused Laminate Chassis	
NSS7222RE187W	3902	NSS7222RE187P	4293	NSS7222RE187G	3902	NSS7222RE187M	2577
NSS6622RE187W	3867	NSS6622RE187P	4255	NSS6622RE187G	3867	NSS6622RE187M	2474
NSS6022RE187W	3810	NSS6022RE187P	4190	NSS6022RE187G	3810	NSS6022RE187M	2372
NSS5422RE187W	3774	NSS5422RE187P	4152	NSS5422RE187G	3774	NSS5422RE187M	2276
NSS4822RE187W	3682	NSS4822RE187P	4050	NSS4822RE187G	3682	NSS4822RE187M	2203
NSS7222RE188W	3902	NSS7222RE188P	4293	NSS7222RE188G	3902	NSS7222RE188M	2577
NSS6622RE188W	3867	NSS6622RE188P	4255	NSS6622RE188G	3867	NSS6622RE188M	2474
NSS6022RE188W	3810	NSS6022RE188P	4190	NSS6022RE188G	3810	NSS6022RE188M	2372
NSS5422RE188W	3774	NSS5422RE188P	4152	NSS5422RE188G	3774	NSS5422RE188M	2276
NSS4822RE188W	3682	NSS4822RE188P	4050	NSS4822RE188G	3682	NSS4822RE188M	2203

Product Features

- Full modesty panel
- Standard Silver Feet (optional White, Black)
- Standard metal grommet matches pull finish
- Features ball bearing suspensions, suspensions are full extension

Notes

- Keyboard not available on noted 48" /54" units. Returns with Grommets in top will automatically have wire channel and outfeed holes in back.
- Laminate version "M" standard w/ open plan back
- Unit not designed for open plan use. Select OPB for Open Plan application

Options

- Accessories**
- K28: Articulating Keyboard w/ Mouse - \$390
- Drawer**
- P33: Wood Drawer Upgrade - \$45 per drawer
 - P40W: extra Box/Box/File or File/File to Knee space - \$910
 - P40M: extra Box/Box/File or File/File to Knee space - \$720
 - WPD3061: Designer White - \$80 per pedestal
- Feet**
- D8: Delete feet (extend fronts to floor) - n/c
- Flush Cut**
- FC-L: Flush Unit Left (Facing) for Ganging - \$55
 - FC-R: Flush Unit Right(Facing) for Ganging - \$55
- Grommets (Non-Standard Location)**
- Provide drawing w/ Grommet Location and Specify Color - \$95 ea.
 - Black: TM30-NS
 - Silver: TM31-NS
 - White: TM34-NS
- Modesty**
- M34T: Drop Door Tech Modesty - \$130
 - M34TM: "M" Style Drop Door Tech Modesty - \$130
 - M51: Open Back Modesty with Wire Mgmt Rail - Deduct \$95
- Open Plan _ Finished Back**
- OPB: "W" "G" Style - Modify Unit for Open Plan Application - \$295
- Premium Finish Option**
- Specify foot Metal Finish color - \$160 per unit. Contact customer service
 - MFB: Black, MFW: White, MFDB: Dark Bronze, MFGM: Matte Gold

2 Select Finish

[Click to view finishes](#)

Metal Finish
 MFS Silver. Additional Metal Finishes are available, options

WAC	WNW
WIC	WWP
WHC	WWW
WOC	WNF(Natural Oak on Flat Cut)
WEC	WSF(Salted Oak on Flat Cut)
WAM	WSM(Salted Oak on Flat Cut)
WCM	WMM(Mocha Oak on Flat Cut)
WEW	WML(Lofty Oak on Flat Cut)
WGW	WGL(Lofty Oak on Flat Cut)
WBW	WBL(Lofty Oak on Flat Cut)
WSW	WSL(Lofty Oak on Flat Cut)

TBCO
 TBSW
 TSTV
 TSMV
 TSLV
 TOBW
 WLO
 WMO
 WNO
 WSO

GAC
 GIC
 GHC
 GOC
 GEC
 GAM
 GCM
 GEW
 GNW
 GSTV +10%

GAC/MAC
 GOC/MOC
 GEC/MEC
 GSTV/MTW
 GSVL/MSW
 GWL/MWL

3 Select Edge

[Click to view edges](#)



4 Select Hardware

[Click to view details](#)

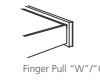
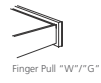
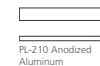
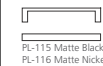
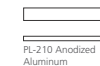
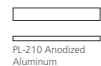

NOT SO square office

"L" Workstation Returns
Multi-File

[Click here to view statement of line](#)

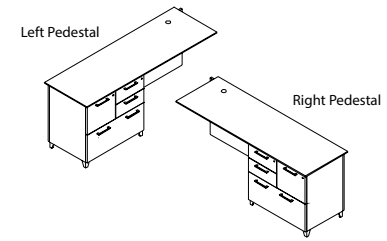

1 Select Model

w" x d" x h"	Weight
Left Pedestal	
72 x 22 x 29	200
66 x 22 x 29	190
60 x 22 x 29	180
54 x 22 x 29	170
48 x 22 x 29	165
Right Pedestal	
72 x 22 x 29	200
66 x 22 x 29	190
60 x 22 x 29	180
54 x 22 x 29	170
48 x 22 x 29	165

Standard Veneer Top Standard Veneer Chassis		Premium Veneer Top Premium Veneer Chassis		High Pressure Laminate Top Veneer Chassis		High Pressure Laminate Top Thermally Fused Laminate Chassis	
NSS7222RE218W	4009	NSS7222RE218P	4411	NSS7222RE218G	4009	NSS7222RE218M	2723
NSS6622RE218W	3975	NSS6622RE218P	4373	NSS6622RE218G	3975	NSS6622RE218M	2622
NSS6022RE218W	3919	NSS6022RE218P	4311	NSS6022RE218G	3919	NSS6022RE218M	2516
NSS5422RE218W	3882	NSS5422RE218P	4271	NSS5422RE218G	3882	NSS5422RE218M	2424
NSS4822RE218W	3788	NSS4822RE218P	4167	NSS4822RE218G	3788	NSS4822RE218M	2351
NSS7222RE219W	4009	NSS7222RE219P	4411	NSS7222RE219G	4009	NSS7222RE219M	2723
NSS6622RE219W	3975	NSS6622RE219P	4373	NSS6622RE219G	3975	NSS6622RE219M	2622
NSS6022RE219W	3919	NSS6022RE219P	4311	NSS6022RE219G	3919	NSS6022RE219M	2516
NSS5422RE219W	3882	NSS5422RE219P	4271	NSS5422RE219G	3882	NSS5422RE219M	2424
NSS4822RE219W	3788	NSS4822RE219P	4167	NSS4822RE219G	3788	NSS4822RE219M	2351

2 Select Finish

[Click to view finishes](#)

Metal Finish
MFS Silver. Additional
Metal Finishes are
available, options

WAC	WNW
WIC	WWP
WHC	WWW
WOC	WNF(Natural Oak on Flat Cut)
WEC	WSF(Salted Oak on Flat Cut)
WAM	WSF(Salted Oak on Flat Cut)
WCM	WMF(Mocha Oak on Flat Cut)
WEW	WLF(Lofty Oak on Flat Cut)
WGW	WLF(Lofty Oak on Flat Cut)
WBW	WLF(Lofty Oak on Flat Cut)
WSW	WLF(Lofty Oak on Flat Cut)

TBCO
TBSW
TSTV
TSMV
TSLV
TOBW
WLO
WMO
WNO
WSO

GAC
GIC
GHC
GOC
GEC
GAM
GCM
GEW
GNW
GSTV +10%

GAC/MAC
GOC/MOC
GEC/MEC
GSTV/MTW
GSLV/MSW
GWL/MWL

3 Select Edge

[Click to view edges](#)



4 Select Hardware

[Click to view details](#)

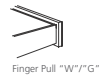
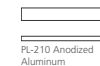
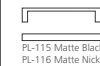
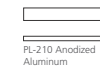
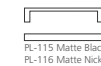
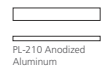

Product Features

- Full modesty panel
- Standard Silver Feet (optional White, Black)
- Standard metal grommet matches pull finish
- Pedestal is 31"W
- iWi & iGi Box and File Drawers feature soft close suspensions (Lateral Drawers Feature ball bearing suspensions), iMi SKUs feature ball bearing suspensions. Both suspensions are full extension

Notes

- Keyboard not available on noted 48"/54" units. Returns with Grommets in top will automatically have wire channel and outfeed holes in back.
- Laminate version "M" standard w/ open plan back
- Unit not designed for open plan use. Select OPB for Open Plan application

Options

Accessories

- K28: Articulating Keyboard w/ Mouse - \$390

Drawer

- P33: Wood Drawer Upgrade - \$45 per drawer
- P40W: extra Box/Box/File or File/File to Knee space - \$910
- P40M: extra Box/Box/File or File/File to Knee space - \$720
- WPD3061: Designer White - \$80 per pedestal

Feet

- D8: Delete feet (extend fronts to floor) - n/c

Flush Cut

- FC-L: Flush Unit Left (Facing) for Ganging - \$55
- FC-R: Flush Unit Right(Facing) for Ganging - \$55

Grommets (Non-Standard Location)

- Provide drawing w/ Grommet Location and Specify Color - \$95 ea.

- Black: TM30-NS

- Silver: TM31-NS

- White: TM34-NS

Modesty

- M34T: Drop Door Tech Modesty - \$130
- M34TM: "M" Style Drop Door Tech Modesty - \$130
- M51: Open Back Modesty with Wire Mgmt Rail - Deduct \$95

Open Plan _ Finished Back

- OPB: "W"/"G" Style - Modify Unit for Open Plan Application - \$295

Premium Finish Option

- Specify foot Metal Finish color - \$160 per unit. Contact customer service
- MFB: Black, MFW: White, MFD: Dark Bronze, MFGM: Matte Gold

NOT SO square office

Workstation Bridges
Open Back Bridge

[Click here to view statement of line](#)

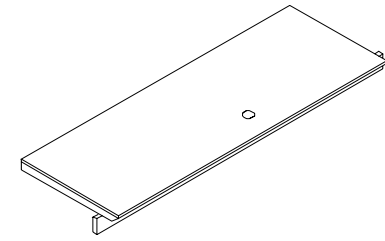

1 Select Model

w" x d" x h"	Weight
48 x 22 x 29	55
42 x 22 x 29	391
36 x 22 x 29	363

Standard Veneer Top Standard Veneer Chassis		Premium Veneer Top Premium Veneer Chassis		High Pressure Laminate Top Veneer Chassis		High Pressure Laminate Top Thermally Fused Laminate Chassis	
NSS4822BR151W	776	NSS4822BR151P	854	NSS4822BR151G	776	NSS4822BR151M	716
NSS4222BR151W	733	NSS4222BR151P	806	NSS4222BR151G	733	NSS4222BR151M	679
NSS3622BR151W	697	NSS3622BR151P	766	NSS3622BR151G	697	NSS3622BR151M	631

Product Features

- Metal grommet matches pull finish
- Standard open back 4" wire management rail

Options

Accessories

- K28: Articulating Keyboard w/ Mouse - \$390
- K31: Center Drawer - \$205
- Grommets (Non-Standard Location)
Provide drawing w/ Grommet Location and Specify Color - \$95 ea.
- Black: TM30-NS
- Silver: TM31-NS
- White: TM34-NS

Modesty

- M34T: Drop Door Tech Modesty - \$130
- M34TM: "M" Style Drop Door Tech Modesty - \$130
- M37: "W" "G" Style Fixed Full Modesty - \$130
- M37M: "M" Style Fixed Full Modesty - \$80

2 Select Finish

[Click to view finishes](#)

WAC	WNW
WIC	WWP
WHC	WWW
WOC	WNF(Natural Oak on Flat Cut)
WEC	WSF(Salted Oak on Flat Cut)
WAM	WMO
WCM	WML(Mocha Oak on Flat Cut)
WEW	WLF(Lofty Oak on Flat Cut)
WGW	WSW
WBW	
WSW	

TBCO	GAC	GSLV +10%
TBSW	GIC	GWL
TSTV	GHC	
TSMV	GOC	
TSLV	GEC	
TOBW	GAM	
WLO	GCM	
WMO	GEW	
WNO	GNW	
WSO	GSTV +10%	

GAC/MAC
GOC/MOC
GEC/MEC
GSTV/MTW
GSLV/MSW
GWL/MWL

3 Select Edge

[Click to view edges](#)



NSS Bevel



NSS Bevel



NSS Bevel



NSS Bevel

4 Select Hardware

[Click to view details](#)

Hardware
N/A

Hardware
N/A

Hardware
N/A

Hardware
N/A

NOT SO square office
Freestanding Lateral File Credenzas
Lateral File/Storage

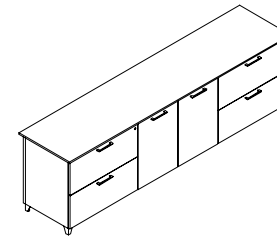

[Click here to view statement of line](#)

1 Select Model

w" x d" x h"
 95 x 22 x 29
 89 x 22 x 29

Weight	Standard Veneer Top Standard Veneer Chassis		Premium Veneer Top Premium Veneer Chassis		High Pressure Laminate Top Veneer Chassis		High Pressure Laminate Top Thermally Fused Laminate Chassis	
	350	NSS9522CA651W	5688	NSS9522CA651P	6257	NSS9522CA651G	5688	NSS9522CA651M
330	NSS8922CA651W	5598	NSS8922CA651P	6158	NSS8922CA651G	5598	NSS8922CA651M	4655

Product Features

- Full height storage has black laminate adjustable shelf
- Full extension drawers - locking
- Features ball bearing suspensions, suspensions are full extension
- Standard Silver Feet (optional White, Black)

Notes

- Unit has black back panel and is not designed for Open Plan use. Select OPB Option for Open Plan application

Options

Door

- D2: Door Lock per door set - \$100
- D6A: "W"/"G" Styles - Delete Doors and replace black laminate shelf with finished shelf - n/c
- D9SC: Soft Close Door Hinges - \$20 per door

Drawer

- P33: Wood Drawer Upgrade - \$45 per drawer
- WPD3061: Designer White - \$80 per pedestal

Feet

- D8: Delete feet (extend fronts to floor) - n/c

Flush Cut

- FC-B: Flush Unit Both Sides(Facing) for Ganging - \$55
- FC-L: Flush Unit Left (Facing) for Ganging - \$55
- FC-R: Flush Unit Right(Facing) for Ganging - \$55

Grommets (Standard Location)

- Specify Color and Location (Right/Left/Center) - \$50 ea.
- Black: TM30-R (Right), TM30-L (Left), TM30-C (Center)
- Silver: TM31-R (Right), TM31-L (Left), TM31-C (Center)
- White: TM34-R (Right), TM34-L (Left), TM34-C (Center)

Grommets (Non-Standard Location)

- Provide drawing w/ Grommet Location and Specify Color - \$95 ea.

- Black: TM30-NS

- Silver: TM31-NS

- White: TM34-NS

Open Plan _ Finished Back

- OPB: "W"/"G" Style - Modify Unit for Open Plan Application - \$295

Shelf

- S714F: Heavy Duty Lumber 1" Shelves - \$80 per shelf ("M" Styles - n/a)

Premium Finish Option

- Specify foot Metal Finish color - \$160 per unit. Contact customer service
- MFB: Black, MFW: White, MFDDB: Dark Bronze, MFGM: Matte Gold

2 Select Finish

[Click to view finishes](#)

Metal Finish

MFS Silver. Additional Metal Finishes are available, options

WAC	WNW	TBCO	GAC	GSLV +10%	GAC/MAC
WIC	WWP	TBSW	GIC	GWL	GOC/MOC
WHC	WWW	TSTV	GHC		GEC/MEC
WOC	WNF(Natural Oak on Flat Cut)	TSMV	GOC		GSTV/MTW
WEC	WSF(Salted Oak on Flat Cut)	TSLV	GEC		GSLV/MSW
WAM	WSM(Mocha Oak on Flat Cut)	TOBW	GAM		GWL/MWL
WCM	WLF(Lofty Oak on Flat Cut)	WLO	GCM		
WEW		WMO	GEW		
WGW		WNO	GNW		
WBW		WSO	GSTV +10%		
WSW					

3 Select Edge

[Click to view edges](#)



NSS Bevel



NSS Bevel



NSS Bevel



NSS Bevel

4 Select Hardware

[Click to view details](#)



PL-115 Matte Black
PL-116 Matte Nickel

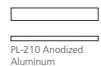

PL-210 Anodized Aluminum



PL-115 Matte Black
PL-116 Matte Nickel



PL-210 Anodized Aluminum



PL-115 Matte Black
PL-116 Matte Nickel

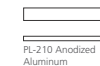

PL-210 Anodized Aluminum

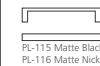

PL-115 Matte Black
PL-116 Matte Nickel



PL-210 Anodized Aluminum



PL-260 Anodized Aluminum
PL-261 White

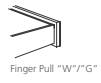

Finger Pull "W"/"G"



PL-260 Anodized Aluminum
PL-261 White



Finger Pull "W"/"G"



PL-260 Anodized Aluminum
PL-261 White

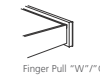

Finger Pull "W"/"G"



PL-260 Anodized Aluminum
PL-261 White

NOT SO square office

File Credenzas
File/File/Kneespace

[Click here to view statement of line](#)

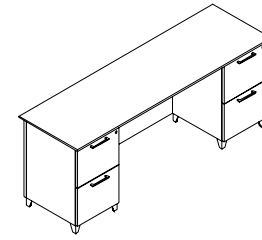

1 Select Model

w" x d" x h"	Weight
84 x 22 x 29	240
72 x 22 x 29	220
66 x 24 x 29	210
60 x 24 x 29	200

Standard Veneer Top Standard Veneer Chassis		Premium Veneer Top Premium Veneer Chassis		High Pressure Laminate Top Veneer Chassis		High Pressure Laminate Top Thermally Fused Laminate Chassis	
NSS8422CA054W	4532	NSS8422CA054P	4986	NSS8422CA054G	4532	NSS8422CA054M	3286
NSS7222CA054W	4196	NSS7222CA054P	4617	NSS7222CA054G	4196	NSS7222CA054M	3071
NSS6622CA054W	4152	NSS6622CA054P	4568	NSS6622CA054G	4152	NSS6622CA054M	3013
NSS6022CA054W	4111	NSS6022CA054P	4523	NSS6022CA054G	4111	NSS6022CA054M	2968

Product Features

- Full modesty back
- Full extension drawers - locking
- Soft close suspension drawer(s)
- Standard Silver Feet (optional White, Black)

Notes

- If a grommet is located in top surface over open knee space, an outfeed hole will be provided in modesty panel
- Unit has black back panel and is not designed for Open Plan use. Select OPB Option for Open Plan application

Options

Accessories

- K28: Articulating Keyboard w/ Mouse - \$390

Drawer

- P6: Modify File/File to Box/Box/File - \$55 per pedestal
- P33: Wood Drawer Upgrade - \$45 per drawer
- WPD3061: Designer White - \$80 per pedestal

Feet

- D8: Delete feet (extend fronts to floor) - n/c

Flush Cut

- FC-B: Flush Unit Both Sides(Facing) for Ganging - \$55
- FC-L: Flush Unit Left (Facing) for Ganging - \$55
- FC-R: Flush Unit Right(Facing) for Ganging - \$55

Grommets (Standard Location)

Specify Color - \$50 ea.

- Black: TM30-C (Center)
- Silver: TM31-C (Center)
- White: TM34-C (Center)

Grommets (Non-Standard Location)

Provide drawing w/ Grommet Location and Specify Color - \$95 ea.

- Black: TM30-NS
- Silver: TM31-NS
- White: TM34-NS

Modesty

- M34T: Drop Door Tech Modesty - \$130
- M34TM: "M" Style Drop Door Tech Modesty - \$130
- M51: Open Back Modesty with Wire Mgmt Rail - Deduct \$95

Open Plan _ Finished Back

- OPB: "W" "G" Style - Modify Unit for Open Plan Application - \$295

Premium Finish Option

- Specify foot Metal Finish color - \$160 per unit. Contact customer service
- MFB: Black, MFW: White, MFDB: Dark Bronze, MFGM: Matte Gold

2 Select Finish

[Click to view finishes](#)

Metal Finish

MFS Silver. Additional Metal Finishes are available, options

WAC	WNW	TBCO	GAC	GSLV +10%	GAC/MAC
WIC	WWP	TBSW	GIC	GWL	GOC/MOC
WHC	WWW	TSTV	GHC		GEC/MEC
WOC	WNF(Natural Oak on Flat Cut)	TSMV	GOC		GSTV/MTW
WEC	WSF(Salted Oak on Flat Cut)	TSLV	GEC		GSLV/MSW
WAM	WSM(Salted Oak on Flat Cut)	TOBW	GAM		GWL/MWL
WCM	WMF(Mocha Oak on Flat Cut)	WLO	GCM		
WEW	WLF(Lofty Oak on Flat Cut)	WMO	GEW		
WGW		WNO	GNW		
WBW		WSO	GSTV +10%		
WSW					

3 Select Edge

[Click to view edges](#)



NSS Bevel



NSS Bevel



NSS Bevel



NSS Bevel

4 Select Hardware

[Click to view details](#)



PL-115 Matte Black
PL-116 Matte Nickel

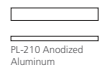

PL-210 Anodized Aluminum



PL-115 Matte Black
PL-116 Matte Nickel



PL-210 Anodized Aluminum



PL-115 Matte Black
PL-116 Matte Nickel

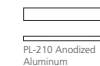

PL-210 Anodized Aluminum

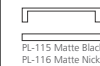

PL-115 Matte Black
PL-116 Matte Nickel



PL-210 Anodized Aluminum



PL-260 Anodized Aluminum
PL-261 White

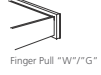

Finger Pull "W"/"G"

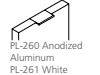

PL-260 Anodized Aluminum
PL-261 White

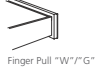

Finger Pull "W"/"G"



PL-260 Anodized Aluminum
PL-261 White



Finger Pull "W"/"G"



PL-260 Anodized Aluminum
PL-261 White

NOT SO square office
Freestanding Storage Credenzas
Storage

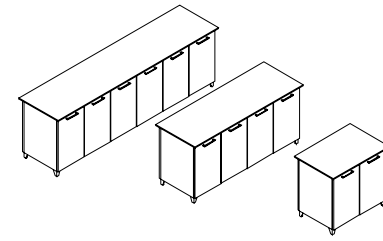













[Click here to view statement of line](#)

1 Select Model

w" x d" x h"
 3 Section
 95 x 22 x 29
 89 x 22 x 29
 2 Section
 72 x 22 x 29
 60 x 22 x 29
 1 Section
 37 x 22 x 29
 31 x 22 x 29

Weight	Standard Veneer Top Standard Veneer Chassis		Premium Veneer Top Premium Veneer Chassis		High Pressure Laminate Top Veneer Chassis		High Pressure Laminate Top Thermally Fused Laminate Chassis	
325	NSS9522CA125W	5477	NSS9522CA125P	6026	NSS9522CA125G	5477	NSS9522CA125M	4215
300	NSS8922CA125W	5385	NSS8922CA125P	5924	NSS8922CA125G	5385	NSS8922CA125M	4105
275	NSS7222CA125W	4398	NSS7222CA125P	4838	NSS7222CA125G	4398	NSS7222CA125M	3100
250	NSS6022CA125W	4268	NSS6022CA125P	4696	NSS6022CA125G	4268	NSS6022CA125M	3019
145	NSS3722CA125W	2351	NSS3722CA125P	2588	NSS3722CA125G	2351	NSS3722CA125M	1665
135	NSS3122CA125W	2221	NSS3122CA125P	2443	NSS3122CA125G	2221	NSS3122CA125M	1618

2 Select Finish	3 Select Edge		4 Select Hardware		
Click to view finishes	WAC	WNW	TBCO	GAC	
	WIC	WWP	TBSW	GIC	
	WHC	WWW	TSTV	GHC	
	WOC	WNF(Natural Oak on Flat Cut)	TSMV	GOC	
Metal Finish	WEC	WSF(Salted Oak on Flat Cut)	TSLV	GEC	
MFS Silver. Additional Metal Finishes are available, options	WAM	WMF(Mocha Oak on Flat Cut)	TOBW	GAM	
	WCM	WLF(Lofty Oak on Flat Cut)	WLO	GCM	
	WEW		WMO	GEW	
	WGW		WNO	GNW	
	WBW		WSO	GSTV +10%	
	WSW				
					
		NSS Bevel	NSS Bevel	NSS Bevel	NSS Bevel
					
		PL-115 Matte Black PL-116 Matte Nickel	PL-210 Anodized Aluminum	PL-115 Matte Black PL-116 Matte Nickel	PL-210 Anodized Aluminum
					
		PL-260 Anodized Aluminum PL-261 White	Finger Pull "W"/"G"	PL-260 Anodized Aluminum PL-261 White	Finger Pull "W"/"G"

Product Features

- Full height storage has 1 adjustable black laminate shelf per section
- Standard Silver Feet (optional White, Black)

Notes

- Unit has black back panel and is not designed for Open Plan use. Select OPB Option for Open Plan application

Options

- Door
- D2: Door lock (only available in panel door) - \$100 per door set
 - D6A: "W"/"G" Styles - Delete Doors and replace black laminate shelf with finished shelf - n/c
 - D9SC: Soft Close Door Hinges - \$20 per door
 - WPD3061: Designer White - \$80 per door
- Feet
- D8: Delete feet (extend fronts to floor) - n/c
- Flush Cut
- FC-B: Flush Unit Both Sides(Facing) for Ganging - \$55
 - FC-L: Flush Unit Left (Facing) for Ganging - \$55
 - FC-R: Flush Unit Right(Facing) for Ganging - \$55
- Grommets (Standard Location)
- Specify Color and Location (Right/Left/Center) - \$50 ea.
- Black: TM30-R (Right), TM30-L (Left), TM30-C (Center)
 - Silver: TM31-R (Right), TM31-L (Left), TM31-C (Center)
 - White: TM34-R (Right), TM34-L (Left), TM34-C (Center)
- Grommets (Non-Standard Location)
- Provide drawing w/ Grommet Location and Specify Color - \$95 ea.
- Black: TM30-NS
 - Silver: TM31-NS
 - White: TM34-NS
- Grommets (Vertical Surface)
- Standard Location - \$50 ea.
- Black Plastic Vertical Surface: TM50-C (Bottom Center)
- Non-Standard Location - \$95 ea.
- Black Plastic Vertical Surface: TM50-NS
- Open Plan _ Finished Back
- OPB: "W"/"G" Style - Modify Unit for Open Plan Application - \$295
- Premium Finish Option
- Specify foot Metal Finish color - \$160 per unit. Contact customer service
 - MFB: Black, MFW: White



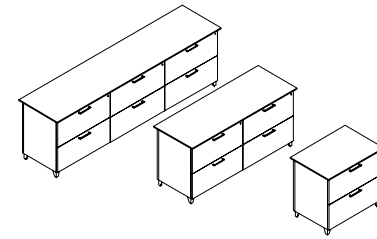













NOT SO square office
Freestanding Lateral File Credenzas
Horizontal Lateral File



[Click here to view statement of line](#)

1 Select Model

w" x d" x h"	Weight
6 Drawer	
95 x 22 x 29	370
89 x 22 x 29	350
4 Drawer	
72 x 22 x 29	315
60 x 22 x 29	275
2 Drawer	
43 x 22 x 29	175
37 x 22 x 29	160
31 x 22 x 29	150

	Standard Veneer Top Standard Veneer Chassis		Premium Veneer Top Premium Veneer Chassis		High Pressure Laminate Top Veneer Chassis		High Pressure Laminate Top Thermally Fused Laminate Chassis	
2 Select Finish Click to view finishes	WAC	WNW	TBCO		GAC	GSLV +10%	GAC/MAC	
	WIC	WWP	TBSW		GIC	GWL	GOC/MOC	
	WHC	WWW	TSTV		GHC		GEC/MEC	
	WOC	WNF(Natural Oak on Flat Cut)	TSMV		GOC		GSTV/MTW	
Metal Finish	WEC	WSF(Salted Oak on Flat Cut)	TSLV		GEC		GSLV/MSW	
MFS Silver. Additional	WAM	WMF(Mocha Oak on Flat Cut)	TOBW		GAM		GWL/MWL	
Metal Finishes are available, options	WCM	WLF(Lofty Oak on Flat Cut)	WLO		GCM			
	WEW		WMO		GEW			
	WGW		WNO		GNW			
	WBW		WSO		GSTV +10%			
	WSW							
3 Select Edge Click to view edges								
	NSS Bevel	NSS Bevel	NSS Bevel	NSS Bevel				
4 Select Hardware Click to view details								
	PL-115 Matte Black PL-116 Matte Nickel	PL-210 Anodized Aluminum	PL-115 Matte Black PL-116 Matte Nickel	PL-210 Anodized Aluminum	PL-115 Matte Black PL-116 Matte Nickel	PL-210 Anodized Aluminum	PL-115 Matte Black PL-116 Matte Nickel	PL-210 Anodized Aluminum
								
	PL-260 Anodized Aluminum PL-261 White	Finger Pull "W"/"G"	PL-260 Anodized Aluminum PL-261 White	Finger Pull "W"/"G"	PL-260 Anodized Aluminum PL-261 White	Finger Pull "W"/"G"	PL-260 Anodized Aluminum PL-261 White	Finger Pull "W"/"G"

Product Features

- Anti-tip safety feature (31"-72")
- Full extension drawers - locking
- Features ball bearing suspensions, suspensions are full extension
- Standard Silver Feet (optional White, Black)

Notes

- Unit has black back panel and is not designed for Open Plan use. Select OPB Option for Open Plan application

Options

- Drawer
- P33: Wood Drawer Upgrade - \$45 per drawer
 - WPD3061: Designer White - \$80 per pedestal
- Feet
- D8: Delete feet (extend fronts to floor) - n/c
- Flush Cut
- FC-B: Flush Unit Both Sides(Facing) for Ganging - \$55
 - FC-L: Flush Unit Left (Facing) for Ganging - \$55
 - FC-R: Flush Unit Right(Facing) for Ganging - \$55
- Open Plan _ Finished Back
- OPB: "W"/"G" Style - Modify Unit for Open Plan Application - \$295
- Premium Finish Option
- Specify foot Metal Finish color - \$160 per unit. Contact customer service
 - MFB: Black, MFW: White

NOT SO square office
Freestanding Lateral File Credenzas
Vertical Lateral File

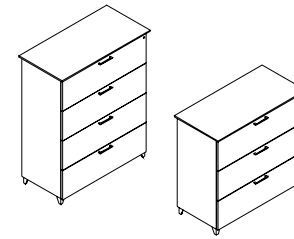

[Click here to view statement of line](#)

1 Select Model

w" x d" x h"

	Weight	Standard Veneer Top Standard Veneer Chassis		Premium Veneer Top Premium Veneer Chassis		High Pressure Laminate Top Veneer Chassis		High Pressure Laminate Top Thermally Fused Laminate Chassis	
4 Drawer									
43 x 22 x 54	290	NSS4322FI111W	4911	NSS4322FI111P	5403	NSS4322FI111G	4911	NSS4322FI111M	3462
37 x 22 x 54	270	NSS3722FI111W	4640	NSS3722FI111P	5105	NSS3722FI111G	4640	NSS3722FI111M	3168
31 x 22 x 54	245	NSS3122FI111W	4469	NSS3122FI111P	4917	NSS3122FI111G	4469	NSS3122FI111M	3072
3 Drawer									
43 x 22 x 42	255	NSS4322FI112W	4568	NSS4322FI112P	5024	NSS4322FI112G	4568	NSS4322FI112M	3149
37 x 22 x 42	235	NSS3722FI112W	4311	NSS3722FI112P	4742	NSS3722FI112G	4311	NSS3722FI112M	2854
31 x 22 x 42	215	NSS3122FI112W	4152	NSS3122FI112P	4568	NSS3122FI112G	4152	NSS3122FI112M	2766

Product Features

- Anti-tip safety feature
- Full extension drawers - locking
- Features ball bearing suspensions, suspensions are full extension
- Standard Silver Feet (optional White, Black)

Notes

- Unit has black back panel and is not designed for Open Plan use. Select OPB Option for Open Plan application

Options

Drawer

- P33: Wood Drawer Upgrade - \$45 per drawer
- WPD3061: Designer White - \$80 per pedestal

Feet

- D8: Delete feet (extend fronts to floor) - n/c

Flush Cut

- FC-B: Flush Unit Both Sides(Facing) for Ganging - \$55
- FC-L: Flush Unit Left (Facing) for Ganging - \$55
- FC-R: Flush Unit Right(Facing) for Ganging - \$55

Open Plan _ Finished Back

- OPB: "W"/"G" Style - Modify Unit for Open Plan Application - \$295

Premium Finish Option

- Specify foot Metal Finish color - \$160 per unit. Contact customer service
- MFB: Black, MFW: White

2 Select Finish

[Click to view finishes](#)

Metal Finish

MFS Silver. Additional Metal Finishes are available, options

WAC	WNW	TBCO	GAC	GSLV +10%	GAC/MAC
WIC	WWP	TBSW	GIC	GWL	GOC/MOC
WHC	WWW	TSTV	GHC		GEC/MEC
WOC	WNF(Natural Oak on Flat Cut)	TSMV	GOC		GSTV/MTW
WEC	WSF(Salted Oak on Flat Cut)	TSLV	GEC		GSLV/MSW
WAM	WCM	TOBW	GAM		GWL/MWL
WCM	WCM	WLO	GCM		
WEW	WEW	WMO	GEW		
WGW	WGW	WNO	GNW		
WBW	WBW	WSO	GSTV +10%		
WSW	WSW				

3 Select Edge

[Click to view edges](#)



NSS Bevel



NSS Bevel



NSS Bevel



NSS Bevel

4 Select Hardware

[Click to view details](#)

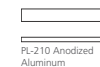
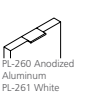
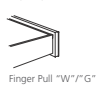
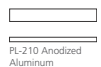
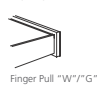
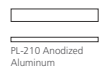
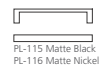

NOT SO square office

Workstation Credenzas

File/File

[Click here to view statement of line](#)

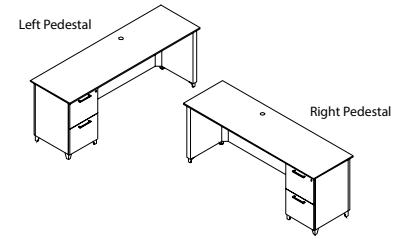

1 Select Model

w" x d" x h"	Weight
Left Pedestal	
89 x 22 x 29	220
84 x 22 x 29	210
72 x 22 x 29	200
66 x 22 x 29	190
Right Pedestal	
89 x 22 x 29	220
84 x 22 x 29	210
72 x 22 x 29	200
66 x 22 x 29	190

Standard Veneer Top Standard Veneer Chassis		Premium Veneer Top Premium Veneer Chassis		High Pressure Laminate Top Veneer Chassis		High Pressure Laminate Top Thermally Fused Laminate Chassis	
NSS8922CA086W	4383	NSS8922CA086P	4821	NSS8922CA086G	4383	NSS8922CA086M	3070
NSS8422CA086W	4311	NSS8422CA086P	4742	NSS8422CA086G	4311	NSS8422CA086M	2863
NSS7222CA086W	3980	NSS7222CA086P	4379	NSS7222CA086G	3980	NSS7222CA086M	2651
NSS6622CA086W	3938	NSS6622CA086P	4333	NSS6622CA086G	3938	NSS6622CA086M	2583
NSS8922CA087W	4383	NSS8922CA087P	4821	NSS8922CA087G	4383	NSS8922CA087M	3070
NSS8422CA087W	4311	NSS8422CA087P	4742	NSS8422CA087G	4311	NSS8422CA087M	2863
NSS7222CA087W	3980	NSS7222CA087P	4379	NSS7222CA087G	3980	NSS7222CA087M	2651
NSS6622CA087W	3938	NSS6622CA087P	4333	NSS6622CA087G	3938	NSS6622CA087M	2583

Product Features

- Full modesty back
- Full extension drawers - locking
- Outfeed hole standard in back of credenza
- Soft close suspension drawer(s)
- Standard metal grommet matches pull finish
- Standard Silver Feet (optional White, Black)

Notes

- Laminate version "M" standard w/ open plan back
- Unit has black back panel and is not designed for Open Plan use. Select OPB Option for Open Plan application

Options

Accessories

- K28: Articulating Keyboard w/ Mouse - \$390

Drawer

- P6: Modify File/File to Box/Box/File - \$55 per pedestal
- P33: Wood Drawer Upgrade - \$45 per drawer
- P40W: extra Box/Box/File or File/File to Knee space - \$910
- P40M: extra Box/Box/File or File/File to Knee space - \$720
- WPD3061: Designer White - \$80 per door

Feet

- D8: Delete feet (extend fronts to floor) - n/c

Flush Cut

- FC-B: Flush Unit Both Sides(Facing) for Ganging - \$55
- FC-L: Flush Unit Left (Facing) for Ganging - \$55
- FC-R: Flush Unit Right(Facing) for Ganging - \$55

Grommets (Non-Standard Location)

Provide drawing w/ Grommet Location and Specify Color - \$95 ea.

- Black: TM30-NS

- Silver: TM31-NS

- White: TM34-NS

Modesty

- M34T: Drop Door Tech Modesty - \$130
- M34TM: "M" Style Drop Door Tech Modesty - \$130
- M51: Open Back Modesty with Wire Mgmt Rail - Deduct \$95

Open Plan _ Finished Back

- OPB: "W" "G" Style - Modify Unit for Open Plan Application - \$195

Premium Finish Option

- Specify foot Metal Finish color - \$160 per unit. Contact customer service
- MFB: Black, MFW: White, MFD: Dark Bronze, MFG: Matte Gold

2 Select Finish

Click to view finishes

WAC	WNW
WIC	WWP
WHC	WWW
WOC	WNF(Natural Oak on Flat Cut)
WEC	WSF(Salted Oak on Flat Cut)
WAM	WSM(Salted Oak on Flat Cut)
WCM	WMM(Mocha Oak on Flat Cut)
WEW	WML(Mocha Oak on Flat Cut)
WGW	WGL(Lofty Oak on Flat Cut)
WBW	WBL(Lofty Oak on Flat Cut)
WSW	WSL(Lofty Oak on Flat Cut)

TBCO
TBSW
TSTV
TSMV
TSLV
TOBW
WLO
WMO
WNO
WSO

GAC
GIC
GHC
GOC
GEC
GAM
GCM
GEW
GNW
GSTV +10%

GAC/MAC
GOC/MOC
GEC/MEC
GSTV/MTW
GSLV/MSW
GWL/MWL

3 Select Edge

Click to view edges



4 Select Hardware

Click to view details

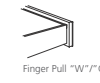
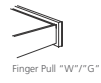
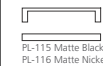
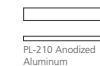
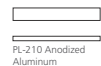

NOT SO square office
Workstation Credenzas
Lateral File

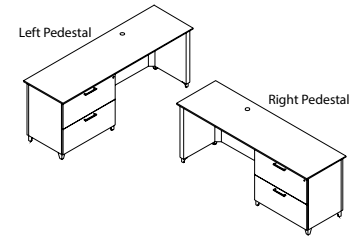

[Click here to view statement of line](#)

1 Select Model

w" x d" x h"	Weight
Left Pedestal	
95 x 22 x 29	265
89 x 22 x 29	250
84 x 22 x 29	240
72 x 22 x 29	230
66 x 22 x 29	215
Right Pedestal	
95 x 22 x 29	265
89 x 22 x 29	250
84 x 22 x 29	240
72 x 22 x 29	230
66 x 22 x 29	215

Standard Veneer Top Standard Veneer Chassis		Premium Veneer Top Premium Veneer Chassis		High Pressure Laminate Top Veneer Chassis		High Pressure Laminate Top Thermally Fused Laminate Chassis	
NSS9522CA066W	4605	NSS9522CA066P	5067	NSS9522CA066G	4605	NSS9522CA066M	3381
NSS8922CA066W	4555	NSS8922CA066P	5011	NSS8922CA066G	4555	NSS8922CA066M	3213
NSS8422CA066W	4412	NSS8422CA066P	4854	NSS8422CA066G	4412	NSS8422CA066M	3017
NSS7222CA066W	4126	NSS7222CA066P	4539	NSS7222CA066G	4126	NSS7222CA066M	2819
NSS6622CA066W	4083	NSS6622CA066P	4492	NSS6622CA066G	4083	NSS6622CA066M	2754
NSS9522CA067W	4605	NSS9522CA067P	5067	NSS9522CA067G	4605	NSS9522CA067M	3381
NSS8922CA067W	4555	NSS8922CA067P	5011	NSS8922CA067G	4555	NSS8922CA067M	3213
NSS8422CA067W	4412	NSS8422CA067P	4854	NSS8422CA067G	4412	NSS8422CA067M	3017
NSS7222CA067W	4126	NSS7222CA067P	4539	NSS7222CA067G	4126	NSS7222CA067M	2819
NSS6622CA067W	4083	NSS6622CA067P	4492	NSS6622CA067G	4083	NSS6622CA067M	2754

Product Features

- All drawers lock
- Full modesty back
- Outfeed hole standard in back of credenza
- Features ball bearing suspensions, suspensions are full extension
- Standard metal grommet matches pull finish
- Standard Silver Feet (optional White, Black)

Notes

- 96, 90, 84 W units have 35W lateral
- 72 and 66 W units have 29W lateral
- Keyboard not available on 66"W Lateral File/Multi-File Units
- Unit has black back panel and is not designed for Open Plan use. Select OPB Option for Open Plan application

Options

Accessories

- K28: Articulating Keyboard w/ Mouse - \$390

Drawer

- P33: Wood Drawer Upgrade - \$45 per drawer
- P40W: extra Box/Box/File or File/File to Knee space - \$910 (n/a on 66")
- P40M: extra Box/Box/File or File/File to Knee space - \$720 (n/a on 66")
- WPD3061: Designer White - \$80 per door

Feet

- D8: Delete feet (extend fronts to floor) - n/c

Flush Cut

- FC-B: Flush Unit Both Sides(Facing) for Ganging - \$55
- FC-L: Flush Unit Left (Facing) for Ganging - \$55
- FC-R: Flush Unit Right(Facing) for Ganging - \$55

Grommets (Non-Standard Location)

Provide drawing w/ Grommet Location and Specify Color - \$95 ea.

- Black: TM30-NS
- Silver: TM31-NS
- White: TM34-NS

Modesty

- M34T: Drop Door Tech Modesty - \$130
- M34TM: "M" Style Drop Door Tech Modesty - \$130
- M51: Open Back Modesty with Wire Mgmt Rail - Deduct \$95

Open Plan _ Finished Back

- OPB: "W" "G" Style - Modify Unit for Open Plan Application - \$195

Premium Finish Option

- Specify foot Metal Finish color - \$160 per unit. Contact customer service
- MFB: Black, MFW: White, MFDB: Dark Bronze, MFGM: Matte Gold

2 Select Finish

[Click to view finishes](#)

Metal Finish

MFS Silver. Additional Metal Finishes are available, options

WAC	WNW	TBCO	GAC	GSLV +10%	GAC/MAC
WIC	WWP	TBSW	GIC	GWL	GOC/MOC
WHC	WWW	TSTV	GHC		GEC/MEC
WOC	WNF(Natural Oak on Flat Cut)	TSMV	GOC		GSTV/MTW
WEC	WSF(Salted Oak on Flat Cut)	TSLV	GEC		GSLV/MSW
WAM	WCM	TOBW	GAM		GWL/MWL
WCM	WCM	WLO	GCM		
WEW	WEW	WMO	GEW		
WGW	WGW	WNO	GNW		
WBW	WBW	WSO	GSTV +10%		
WSW	WSW				

3 Select Edge

[Click to view edges](#)



4 Select Hardware

[Click to view details](#)

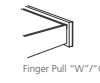
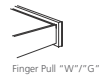
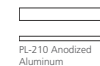
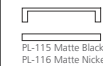
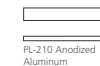
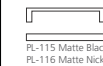
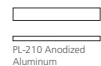

NOT SO square office

Workstation Credenzas
Multi-File

[Click here to view statement of line](#)

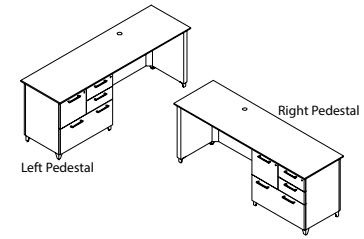

1 Select Model

w" x d" x h"	Weight
Left Pedestal	
95 x 22 x 29	265
89 x 22 x 29	250
84 x 22 x 29	240
72 x 22 x 29	230
*66 x 22 x 29	215
Right Pedestal	
95 x 22 x 29	265
89 x 22 x 29	250
84 x 22 x 29	240
72 x 22 x 29	230
*66 x 22 x 29	215

	Standard Veneer Top Standard Veneer Chassis		Premium Veneer Top Premium Veneer Chassis		High Pressure Laminate Top Veneer Chassis		High Pressure Laminate Top Thermally Fused Laminate Chassis	
NSS9522CA667W	4709	NSS9522CA667P	5181	NSS9522CA667G	4709	NSS9522CA667M	3413	
NSS8922CA667W	4662	NSS8922CA667P	5129	NSS8922CA667G	4662	NSS8922CA667M	3366	
NSS8422CA667W	4520	NSS8422CA667P	4972	NSS8422CA667G	4520	NSS8422CA667M	3171	
NSS7222CA667W	4232	NSS7222CA667P	4656	NSS7222CA667G	4232	NSS7222CA667M	2971	
NSS6622CA667W	4190	NSS6622CA667P	4609	NSS6622CA667G	4190	NSS6622CA667M	2908	
NSS9522CA668W	4709	NSS9522CA668P	5181	NSS9522CA668G	4709	NSS9522CA668M	3413	
NSS8922CA668W	4662	NSS8922CA668P	5129	NSS8922CA668G	4662	NSS8922CA668M	3366	
NSS8422CA668W	4520	NSS8422CA668P	4972	NSS8422CA668G	4520	NSS8422CA668M	3171	
NSS7222CA668W	4232	NSS7222CA668P	4656	NSS7222CA668G	4232	NSS7222CA668M	2971	
NSS6622CA668W	4190	NSS6622CA668P	4609	NSS6622CA668G	4190	NSS6622CA668M	2908	

Product Features

- Full modesty back
- Outfeed hole standard in back of credenza
- iWi & iGi Box and File Drawers feature soft close suspensions (Lateral Drawers Feature ball bearing suspensions), iMi SKUs feature ball bearing suspensions. Both suspensions are full extension
- Standard metal grommet matches pull finish
- Standard Silver Feet (optional White, Black)

Notes

- Keyboard not available on 66"W Lateral File/Multi-File Units
- Unit not designed for open plan use. Select OPB for Open Plan application

Options

- Accessories
- K28: Articulating Keyboard w/ Mouse - \$390
- Drawer
- P33: Wood Drawer Upgrade - \$45 per drawer
 - P40W: extra Box/Box/File or File/File to Knee space - \$910 (n/a on 66")
 - P40M: extra Box/Box/File or File/File to Knee space - \$720 (n/a on 66")
 - WPD3061: Designer White - \$80 per door
- Feet
- D8: Delete feet (extend fronts to floor) - n/c
- Flush Cut
- FC-B: Flush Unit Both Sides(Facing) for Ganging - \$55
 - FC-L: Flush Unit Left (Facing) for Ganging - \$55
 - FC-R: Flush Unit Right(Facing) for Ganging - \$55
- Grommets (Non-Standard Location)
- Provide drawing w/ Grommet Location and Specify Color - \$95 ea.
- Black: TM30-NS
 - Silver: TM31-NS
 - White: TM34-NS
- Modesty
- M34T: Drop Door Tech Modesty - \$130
 - M34TM: "M" Style Drop Door Tech Modesty - \$130
 - M51: Open Back Modesty with Wire Mgmt Rail - Deduct \$95
- Open Plan _ Finished Back
- OPB: "W" "G" Style - Modify Unit for Open Plan Application - \$195
- Premium Finish Option
- Specify foot Metal Finish color - \$160 per unit. Contact customer service
 - MFB: Black, MFW: White, MFD: Dark Bronze, MFGM: Matte Gold

2 Select Finish

Click to view finishes

WAC	WNW
WIC	WWP
WHC	WWW
WOC	WNF(Natural Oak on Flat Cut)
WEC	WSF(Salted Oak on Flat Cut)
WAM	WSM(Salted Oak on Flat Cut)
WCM	WMM(Mocha Oak on Flat Cut)
WEW	WMO(Mocha Oak on Flat Cut)
WGW	WNO(Lofty Oak on Flat Cut)
WBW	WLF(Lofty Oak on Flat Cut)
WSW	WLS(Lofty Oak on Flat Cut)

TBCO
TBSW
TSTV
TSMV
TSLV
TOBW
WLO
WMO
WNO
WSO

GAC
GIC
GHC
GOC
GEC
GAM
GCM
GEW
GNW
GSTV +10%

GAC/MAC
GOC/MOC
GEC/MEC
GSTV/MTW
GSLV/MSW
GWL/MWL

3 Select Edge

Click to view edges



NSS Bevel



NSS Bevel



NSS Bevel



NSS Bevel

4 Select Hardware

Click to view details



PL-115 Matte Black
PL-116 Matte Nickel

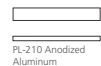

PL-210 Anodized Aluminum



PL-115 Matte Black
PL-116 Matte Nickel



PL-210 Anodized Aluminum

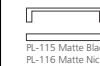

PL-115 Matte Black
PL-116 Matte Nickel

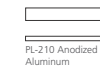

PL-210 Anodized Aluminum

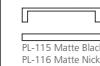

PL-115 Matte Black
PL-116 Matte Nickel

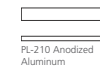

PL-210 Anodized Aluminum



PL-260 Anodized Aluminum
PL-261 White



Finger Pull "W"/"G"



PL-260 Anodized Aluminum
PL-261 White



Finger Pull "W"/"G"



PL-260 Anodized Aluminum
PL-261 White



Finger Pull "W"/"G"



PL-260 Anodized Aluminum
PL-261 White

NOT SO square office

Bench Cabinets One / Two / Three Section Storage

[Click here to view statement of line](#)

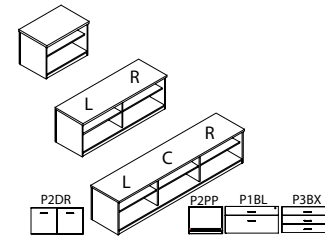

1 Select Model

w" x d" x h"
Three Section
93.5 x 20 x 23
87.5 x 20 x 23
Two Section
70.5 x 20 x 23
58.5 x 20 x 23
One Section
35.5 x 20 x 23
29.5 x 20 x 23

Weight	Standard Veneer Top Standard Veneer Chassis		Premium Veneer Top Premium Veneer Chassis		High Pressure Laminate Top Veneer Chassis		Thermally Fused Laminate Top Thermally Fused Laminate Chassis	
300	NSS9320CA063W	4505	NSS9320CA063P	4957	NSS9320CA063G	4505	NSS9320CA063M	2938
290	NSS8720CA063W	4168	NSS8720CA063P	4586	NSS8720CA063G	4168	NSS8720CA063M	2649
225	NSS7020CA063W	2980	NSS7020CA063P	3278	NSS7020CA063G	2980	NSS7020CA063M	2213
210	NSS5820CA063W	2808	NSS5820CA063P	3090	NSS5820CA063G	2808	NSS5820CA063M	2053
95	NSS3520CA063W	1568	NSS3520CA063P	1725	NSS3520CA063G	1568	NSS3520CA063M	905
90	NSS2920CA063W	1527	NSS2920CA063P	1680	NSS2920CA063G	1527	NSS2920CA063M	865

Product Features

- 1 1/8" top with flat edges
- Open plan - back
- Standard open storage with shelves

Notes

- To use Runoff Desk with Bench Cabinets, order Bench Runoff Support Ends: see Runoff Desk
- Bench Cushion Top factory installed as specified
- Standard without legs
- For drawers, storage and printer cabinets select options below

Options

Cabinet

- P1BL: Box/Lateral File - \$315 M / \$620 W
- P2DR: Storage Door - \$185 M / \$290 W
- P2PP: Open Printer Pullout - \$235 M / \$340 W
- P3BX: Three Box Drawers - \$315 M / \$515 W

Shelf

- S714F: Heavy Duty Lumber 1" Shelves - \$80 per shelf ("M" Styles - n/a)

Feet

- MTL50: 4 Silver Feet - \$205

Grommets (Standard Location)

Specify Color and Location (Right/Left/Center) - \$50 ea.

- Black: TM30-R (Right), TM30-L (Left), TM30-C (Center)

- Silver: TM31-R (Right), TM31-L (Left), TM31-C (Center)

- White: TM34-R (Right), TM34-L (Left), TM34-C (Center)

Grommets (Non-Standard Location)

Provide drawing w/ Grommet Location and Specify Color - \$95 ea.

- Black: TM30-NS, Silver: TM31-NS, White: TM34-NS

Grommets (Vertical Surface)

- Standard Location Black Plastic Vertical Surface: TM50-C (Bottom Center) - \$50 ea.

- Non-Standard Location Black Plastic Vertical Surface: TM50-NS - \$95 ea.

Cushion

- BC20: Bench Cushion

- Specify location, number of cushions and fabric grade.

- Cushions sold individually w/a max width 35" (to match storage section depth). 29"W requires .75 yd., 35"W requires 1 yd.

BC20 Bench Cushion fabric grades

COM	COL	1	2	3
282	301	319	337	355
4	5	6	7	8
373	391	409	427	445
9	10	11/L1	12	13/L2
463	481	499	517	535

2 Select Finish

Click to view finishes

WAC	WNW	TBCO	GAC	GSLV	MAC
WIC	WWP	TBSW	GIC	+10%	MOC
WHC	WWW	TSTV	GHC	GWL	MEC
WOC	WNF(Natural Oak on Flat Cut)	TSMV	GOC		MGW
WEC	WSF(Salted Oak on Flat Cut)	TSLV	GEC		MTW
WAM	WSF(Salted Oak on Flat Cut)	TOBW	GAM		MSW
WCM	WLO	WLO	GCM		MWL
WEW	WMF(Mocha Oak on Flat Cut)	WMO	GEW		
WGW	WLF(Lofty Oak on Flat Cut)	WNO	GNW		
WBW	WSW	WSO	GSTV +10%		

3 Select Edge

Click to view edges

Edge
N/A

Edge
N/A

Edge
N/A

Edge
N/A

4 Select Hardware

Click to view details

Hardware
N/A

Hardware
N/A

Hardware
N/A

Hardware
N/A

NOT SO square office
Freestanding Mobile Pedestal
Mobile Pedestal - Under Surface

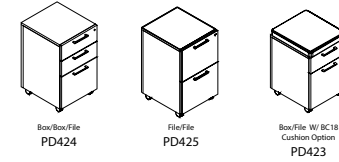

[Click here to view statement of line](#)

1 Select Model

w" x d" x h"
 Box/Box/File
 16 x 18 x 27
 File/File
 16 x 18 x 27
 Box/File
 16 x 18 x 23

Weight	Standard Veneer Top Standard Veneer Chassis	Premium Veneer Top Premium Veneer Chassis	High Pressure Laminate Top Veneer Chassis	Thermally Fused Laminate Top Thermally Fused Laminate Chassis
90	NSS1618PD424W 1509	NSS1618PD424P 1661	"G" Option N/A	NSS1618PD424M 1133
90	NSS1618PD425W 1509	NSS1618PD425P 1661	"G" Option N/A	NSS1618PD425M 1133
90	NSS1618PD423W 1359	NSS1618PD423P 1496	"G" Option N/A	NSS1618PD423M 1019

Product Features

- Anti-tip safety feature
- For open plan use under surfaces
- Full extension drawers - locking

Notes

- Pedestal Cushion can be specified on all pedestals, but on Box/ Box/ File and File/File unit will not fit under work surface w/ cushion.

Options

- Cushion**
- BC16: Bench Cushion
 - Specify fabric grade (1 yd. required)
- Drawer**
- P33: Wood Drawer Upgrade - \$45 per drawer
 - WPD3061: Designer White - \$80 per pedestal
- Premium Finish Option**
- Specify foot Metal Finish color - \$30 per foot
 - MFB: Black, MFW: White

BC16 Cushion fabric grades

COM	COL	1	2	3
224	243	261	279	297
4	5	6	7	8
315	333	351	369	387
9	10	11/ L1	12	13/ L2
405	423	441	459	495

2 Select Finish

Click to view finishes

WAC	WNW	TBCO	MAC
WIC	WWP	TBSW	MOC
WHC	WWW	TSTV	MEC
WOC	WNF(Natural Oak on Flat Cut)	TSMV	MGW
WEC	WSF(Salted Oak on Flat Cut)	TSLV	MTW
WAM	WSF(Salted Oak on Flat Cut)	TOBW	MSW
WCM	WMF(Mocha Oak on Flat Cut)	WLO	MWL
WEW	WMF(Mocha Oak on Flat Cut)	WMO	
WGW	WLF(Lofty Oak on Flat Cut)	WNO	
WBW	WLF(Lofty Oak on Flat Cut)	WSO	
WSW	WLF(Lofty Oak on Flat Cut)		

3 Select Edge

Click to view edges



4 Select Hardware

Click to view details

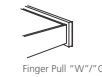
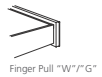
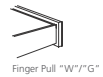
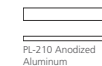
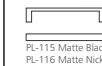
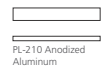

NOT SO square office
Single Storage Overhead Consoles
Panel Door - 6/4/2 Door

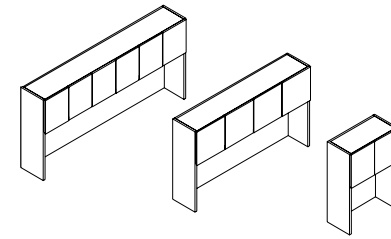

[Click here to view statement of line](#)

1 Select Model

w" x d" x h"
 6 Door / 3 Section
 93 x 14 x 42
 87 x 14 x 42
 4 Door / 2 Section
 83 x 14 x 42
 76 x 14 x 42
 70 x 14 x 42
 64 x 14 x 42
 58 x 14 x 42
 47 x 14 x 42
 2 Door / 1 Section
 35 x 14 x 42
 29 x 14 x 42

Weight	Standard Veneer Top Standard Veneer Chassis		Premium Veneer Top Premium Veneer Chassis		High Pressure Laminate Top Veneer Chassis	Thermally Fused Laminate Top Thermally Fused Laminate Chassis	
		NSS9342OH325W	4562	NSS9342OH325P	5019	"G" Option N/A	NSS9342OH325M
315	NSS8742OH325W	4398	NSS8742OH325P	4838	"G" Option N/A	NSS8742OH325M	2877
	NSS8342OH325W	3998	NSS8342OH325P	4398	"G" Option N/A	NSS8342OH325M	2342
275	NSS7642OH325W	3723	NSS7642OH325P	4097	"G" Option N/A	NSS7642OH325M	2252
255	NSS7042OH325W	3453	NSS7042OH325P	3798	"G" Option N/A	NSS7042OH325M	1924
240	NSS6442OH325W	3368	NSS6442OH325P	3704	"G" Option N/A	NSS6442OH325M	1842
225	NSS5842OH325W	3280	NSS5842OH325P	3609	"G" Option N/A	NSS5842OH325M	1769
210	NSS4742OH325W	3110	NSS4742OH325P	3422	"G" Option N/A	NSS4742OH325M	1612
190							
	NSS3542OH325W	2034	NSS3542OH325P	2238	"G" Option N/A	NSS3542OH325M	1036
120	NSS2942OH325W	1977	NSS2942OH325P	2176	"G" Option N/A	NSS2942OH325M	985
105							

2 Select Finish

Click to view finishes

WAC	WNW	TBCO	MAC
WIC	WWP	TBSW	MOC
WHC	WWW	TSTV	MEC
WOC	WNF(Natural Oak on Flat Cut)	TSMV	MGW
WEC	WSF(Salted Oak on Flat Cut)	TSLV	MTW
WAM	WCM	TOBW	MSW
WCM	WCV	WLO	MWL
WEW	WEM	WMO	
WGW	WEM	WNO	
WBW	WEM	WSO	
WSW	WEM		

3 Select Edge

Click to view edges

Edge	Edge	Edge	Edge
N/A	N/A	N/A	N/A

4 Select Hardware

Click to view details

Hardware	Hardware	Hardware	Hardware
N/A	N/A	N/A	N/A

Product Features

- Finished top
- Interior cabinet depth 12.5"
- Panel doors with concealed finger pull
- 5/8" grommet(s) included for task light wire management

Notes

- Unit has black back panel and is not designed for Open Plan use. Select OPB Option for Open Plan application

Options

- Door
 - D2: Door Lock - \$100 per door set
 - D6: Delete Doors - n/c
 - D9SC: Soft Close Door Hinges - \$20 per door
 - WPD3061: Designer White - \$80 per door
- Grommets (Vertical Surface)
 - Standard Location - \$50 ea.
 - Black Plastic Vertical Surface: TM50-C (Bottom Center)
 - Non-Standard Location - \$95 ea.
 - Black Plastic Vertical Surface: TM50-NS
- Interior Cabinet Lighting
 - LEDPK starter kit includes Infeed, 1 Puck Interior Light and the ability to daisy chain up to 6 total Puck Lights
 - LED Puck Starter Kit - \$310
 - PK: 1 LED Interior Light - \$130
- Task Lighting
 - Overhead task light cord is located on the right facing side. If the opposite location is required please contact customer service.
 - LT-LED24: 24" LED Task light - \$215
 - LT-LED48: 48" LED Task light - \$270
 - LT-LED60: 60" LED Task light - \$335
 - LT-LED72: 72" LED Task light - \$360
- Open Plan _ Finished Back
 - OPB: "W" "G" Style - Modify Unit for Open Plan Application - \$295
 - OPBM: "M" Style - Modify Unit for Open Plan Application - \$95

NOT SO square office
 Single Storage Overhead Consoles
 Silverluma Frame Doors / 6/4/2 Door

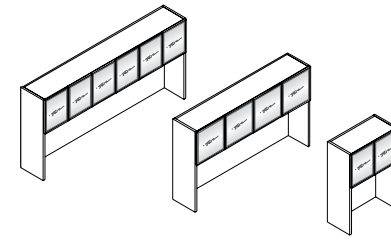

[Click here to view statement of line](#)

1 Select Model

w" x d" x h"
 6 Door / 3 Section
 93 x 14 x 42
 87 x 14 x 42
 4 Door / 2 Section
 83 x 14 x 42
 76 x 14 x 42
 70 x 14 x 42
 64 x 14 x 42
 58 x 14 x 42
 47 x 14 x 42
 2 Door / 1 Section
 35 x 14 x 42
 29 x 14 x 42

Weight	Standard Veneer Top Standard Veneer Chassis		Premium Veneer Top Premium Veneer Chassis		High Pressure Laminate Top Veneer Chassis	Thermally Fused Laminate Top Thermally Fused Laminate Chassis	
		NSS9342OH321W	5120	NSS9342OH321P	5633	"G" Option N/A	NSS9342OH321M
315	NSS8742OH321W	4992	NSS8742OH321P	5491	"G" Option N/A	NSS8742OH321M	3348
	NSS8342OH321W	4928	NSS8342OH321P	5420	"G" Option N/A	NSS8342OH321M	2653
275	NSS7642OH321W	4281	NSS7642OH321P	4709	"G" Option N/A	NSS7642OH321M	2564
285	NSS7042OH321W	3980	NSS7042OH321P	4379	"G" Option N/A	NSS7042OH321M	2237
	NSS6442OH321W	3826	NSS6442OH321P	4210	"G" Option N/A	NSS6442OH321M	2156
210	NSS5842OH321W	3723	NSS5842OH321P	4097	"G" Option N/A	NSS5842OH321M	2084
190	NSS4742OH321W	3588	NSS4742OH321P	3948	"G" Option N/A	NSS4742OH321M	1927
	NSS3542OH321W	2309	NSS3542OH321P	2540	"G" Option N/A	NSS3542OH321M	1193
120	NSS2942OH321W	2173	NSS2942OH321P	2390	"G" Option N/A	NSS2942OH321M	1140
105							

2 Select Finish

[Click to view finishes](#)

WAC	WNW	TBCO	MAC
WIC	WWP	TBSW	MOC
WHC	WWW	TSTV	MEC
WOC	WNF(Natural Oak	TSMV	MGW
WEC	on Flat Cut)	TSLV	MTW
WAM	WSF(Salted Oak	TOBW	MSW
WCM	on Flat Cut)	WLO	MWL
WEW	WMF(Mocha Oak	WMO	
WGW	on Flat Cut)	WNO	
WBW	WLF(Lofty Oak on	WSO	
WSW	Flat Cut)		

3 Select Edge

[Click to view edges](#)

Edge
N/A

Edge
N/A

Edge
N/A

4 Select Hardware

[Click to view details](#)

Hardware
N/A

Hardware
N/A

Hardware
N/A

Product Features

- Finished top
- Interior cabinet depth 12.5"
- SilverLuma frame doors with frosted acrylic inserts
- 5/8" grommet(s) included for task light wire management

Notes

- Unit has black back panel and is not designed for Open Plan use. Select OPB Option for Open Plan application

Options

- Door
- D2: Door Lock - \$100 per door set
 - D6: Delete Doors - n/c
 - D9SC: Soft Close Door Hinges - \$20 per door
- Grommets (Vertical Surface)
- Standard Location - \$50 ea.
- Black Plastic Vertical Surface: TM50-C (Bottom Center)
- Non-Standard Location - \$95 ea.
- Black Plastic Vertical Surface: TM50-NS
- Interior Cabinet Lighting
- LEDPK starter kit includes Infeed, 1 Puck Interior Light and the ability to daisy chain up to 6 total Puck Lights
- LED Puck Starter Kit - \$310
 - PK: 1 LED Interior Light - \$130
- Task Lighting
- Overhead task light cord is located on the right facing side. If the opposite location is required please contact customer service.
- LT-LED24: 24" LED Task light - \$215
 - LT-LED48: 48" LED Task light - \$270
 - LT-LED60: 60" LED Task light - \$335
 - LT-LED72: 72" LED Task light - \$360
- Open Plan _ Finished Back
- OPB: "W""G" Style - Modify Unit for Open Plan Application - \$295
 - OPBM: "M" Style - Modify Unit for Open Plan Application - \$95

NOT SO square office
 Single Storage Overhead Consoles
 Open Storage Console

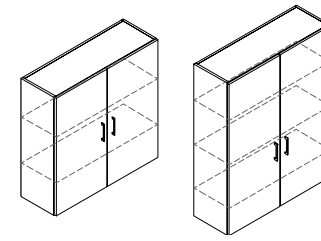

[Click here to view statement of line](#)

1 Select Model

w" x d" x h"	Weight
3 Section	
93 x 14 x 42	310
87 x 14 x 42	280
83 x 14 x 42	265
76 x 14 x 42	250
2 Section	
70 x 14 x 42	240
64 x 14 x 42	225
58 x 14 x 42	205

	Standard Veneer Top Standard Veneer Chassis		Premium Veneer Top Premium Veneer Chassis		High Pressure Laminate Top Veneer Chassis	Thermally Fused Laminate Top Thermally Fused Laminate Chassis
	NSS9342OH346W	4168	NSS9342OH346P	4586	"G" Option N/A	NSS9342OH346M 2645
	NSS8742OH346W	4126	NSS8742OH346P	4539	"G" Option N/A	NSS8742OH346M 2477
	NSS8342OH346W	4089	NSS8342OH346P	4499	"G" Option N/A	NSS8342OH346M 1934
	NSS7642OH346W	3524	NSS7642OH346P	3876	"G" Option N/A	NSS7642OH346M 1850
	NSS7042OH346W	3252	NSS7042OH346P	3577	"G" Option N/A	NSS7042OH346M 1661
	NSS6442OH346W	3173	NSS6442OH346P	3491	"G" Option N/A	NSS6442OH346M 1581
	NSS5842OH346W	3122	NSS5842OH346P	3435	"G" Option N/A	NSS5842OH346M 1502

2 Select Finish
 Click to view finishes

WAC	WNW
WIC	WWP
WHC	WWW
WOC	WNF(Natural Oak on Flat Cut)
WEC	WSF(Salted Oak on Flat Cut)
WAM	WSF(Salted Oak on Flat Cut)
WCM	WMF(Mocha Oak on Flat Cut)
WEW	WLF(Lofty Oak on Flat Cut)
WGW	WSO
WBW	
WSW	

TBCO
 TBSW
 TSTV
 TSMV
 TSLV
 TOBW
 WLO
 WMO
 WNO
 WSO

MAC
 MOC
 MEC
 MGW
 MTW
 MSW
 MWL

3 Select Edge
 Click to view edges

Edge
 N/A

Edge
 N/A

Edge
 N/A

4 Select Hardware
 Click to view details

Hardware
 N/A

Hardware
 N/A

Hardware
 N/A

Product Features

- Finished top
- Interior cabinet depth 12.5"
- 5/8" grommet(s) included for task light wire management

Notes

- 1 or 2 optional door available
- Sliding Doors Will Not Pass Each Other
- Unit has black back panel and is not designed for Open Plan use. Select OPB Option for Open Plan application

Options

- Grommets (Vertical Surface)
 - Standard Location - \$50 ea.
 - Black Plastic Vertical Surface: TM50-C (Bottom Center)
 - Non-Standard Location - \$95 ea.
 - Black Plastic Vertical Surface: TM50-NS
- Interior Cabinet Lighting
 - LEDPK starter kit includes Infeed, 1 Puck Interior Light and the ability to daisy chain up to 6 total Puck Lights
 - LED Puck Starter Kit - \$310
 - PK: 1 LED Interior Light - \$130
- Open Plan _ Finished Back
 - OPB: "W" "G" Style - Modify Unit for Open Plan Application - \$295
 - OPBM: "M" Style - Modify Unit for Open Plan Application - \$95
- Sliding Door
 - SLD17LD: Laminate Door - \$205 per door
 - SLD17FD: SilverLuma / Frost Door ("W", "M" only) - \$365 per door
 - SLD17WD: Wood Door - \$260 per door
- Task Lighting
 - Overhead task light cord is located on the right facing side. If the opposite location is required please contact customer service.
 - LT-LED24: 24" LED Task light - \$215
 - LT-LED48: 48" LED Task light - \$270
 - LT-LED60: 60" LED Task light - \$335
 - LT-LED72: 72" LED Task light - \$360

NOT SO square office
 Double Height Overhead Consoles
 Panel Door

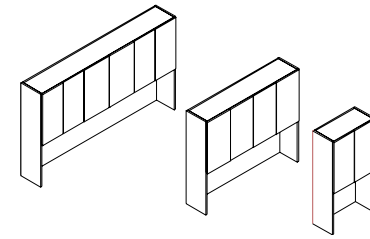

[Click here to view statement of line](#)

1 Select Model

- w" x d" x h"
 6 Door / 3 Section
 93 x 14 x 54
 87 x 14 x 54
 83 x 14 x 54
 4 Door / 2 Section
 70 x 14 x 54
 64 x 14 x 54
 58 x 14 x 54
 2 Door / 1 Section
 35 x 14 x 54
 29 x 14 x 54

Weight

		Standard Veneer Top Standard Veneer Chassis		Premium Veneer Top Premium Veneer Chassis		High Pressure Laminate Top Veneer Chassis		Thermally Fused Laminate Top Thermally Fused Laminate Chassis	
	300	NSS9354OH325W	5184	NSS9354OH325P	5703	"G" Option N/A	NSS9354OH325M	3707	
	290	NSS8754OH325W	5028	NSS8754OH325P	5532	"G" Option N/A	NSS8754OH325M	3563	
	280	NSS8354OH325W	4955	NSS8354OH325P	5450	"G" Option N/A	NSS8354OH325M	2869	
	250	NSS7054OH325W	4218	NSS7054OH325P	4642	"G" Option N/A	NSS7054OH325M	2591	
	230	NSS6454OH325W	3980	NSS6454OH325P	4379	"G" Option N/A	NSS6454OH325M	2502	
	215	NSS5854OH325W	3867	NSS5854OH325P	4255	"G" Option N/A	NSS5854OH325M	2161	
	160	NSS3554OH325W	2374	NSS3554OH325P	2612	"G" Option N/A	NSS3554OH325M	1413	
	150	NSS2954OH325W	2290	NSS2954OH325P	2519	"G" Option N/A	NSS2954OH325M	1368	

2 Select Finish

[Click to view finishes](#)

- WAC
 WIC
 WHC
 WOC
 WEC
 WAM
 WCM
 WEW
 WGW
 WBW
 WSW

- WNW
 WWP
 WWW
 WNF(Natural Oak on Flat Cut)
 WSF(Salted Oak on Flat Cut)
 WMF(Mocha Oak on Flat Cut)
 WLF(Lofty Oak on Flat Cut)

- TBCO
 TBSW
 TSTV
 TSMV
 TSLV
 TOBW
 WLO
 WMO
 WNO
 WSO

- MAC
 MOC
 MEC
 MGW
 MTW
 MSW
 MWL

3 Select Edge

[Click to view edges](#)

Edge
 N/A

Edge
 N/A

Edge
 N/A

4 Select Hardware

[Click to view details](#)

Hardware
 N/A

Hardware
 N/A

Hardware
 N/A

Product Features

- Finished top
- 1 Adjustable shelf behind each door section
- Interior cabinet depth 12.5"
- Interior shelf depth 12"
- Panel doors with concealed finger pull
- 5/8" grommet(s) included for task light wire management

Notes

- Unit has black back panel and is not designed for Open Plan use. Select OPB Option for Open Plan application.

Options

- Door
- D2: Door Lock - \$100 per door set
 - D6: Delete Doors - n/c
 - D9SC: Soft Close Door Hinges - \$20 per door
 - WPD3061: Designer White - \$80 per door
- Grommets (Vertical Surface)
 Standard Location - \$50 ea.
 - Black Plastic Vertical Surface: TM50-C (Bottom Center)
 Non-Standard Location - \$95 ea.
 - Black Plastic Vertical Surface: TM50-NS
- Interior Cabinet Lighting
 LEDPK starter kit includes Infeed, 1 Puck Interior Light and the ability to daisy chain up to 6 total Puck Lights
 - LED Puck Starter Kit - \$310
 - PK: 1 LED Interior Light - \$130
- Task Lighting
 Overhead task light cord is located on the right facing side. If the opposite location is required please contact customer service.
- LT-LED24: 24" LED Task light - \$215
 - LT-LED48: 48" LED Task light - \$270
 - LT-LED60: 60" LED Task light - \$335
 - LT-LED72: 72" LED Task light - \$360
- Open Plan _ Finished Back
 - OPB: "W" "G" Style - Modify Unit for Open Plan Application - \$295
 - OPBM: "M" Style - Modify Unit for Open Plan Application - \$95
- Shelf
 - S714F: Heavy Duty Lumber 1" Shelves - \$80 per shelf ("M" Styles - n/a)

NOT SO square office
 Double Height Overhead Consoles
 Silverluma Frame 6/4/2 Doors

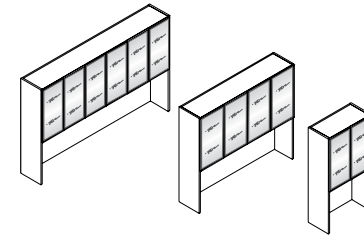

[Click here to view statement of line](#)

1 Select Model

- w" x d" x h"
 6 Door / 3 Section
 93 x 14 x 54
 87 x 14 x 54
 4 Door / 2 Section
 70 x 14 x 54
 64 x 14 x 54
 58 x 14 x 54
 2 Door / 1 Section
 35 x 14 x 54
 29 x 14 x 54

Weight	Standard Veneer Top Standard Veneer Chassis		Premium Veneer Top Premium Veneer Chassis		High Pressure Laminate Top Veneer Chassis	Thermally Fused Laminate Top Thermally Fused Laminate Chassis
	300	NSS9354OH321W	6359	NSS9354OH321P	6995	"G" Option N/A
290	NSS8754OH321W	6100	NSS8754OH321P	6709	"G" Option N/A	NSS8754OH321M 4349
250	NSS7054OH321W	5298	NSS7054OH321P	5828	"G" Option N/A	NSS7054OH321M 3116
230	NSS6454OH321W	4691	NSS6454OH321P	5160	"G" Option N/A	NSS6454OH321M 3026
215	NSS5854OH321W	4475	NSS5854OH321P	4922	"G" Option N/A	NSS5854OH321M 2686
160	NSS3554OH321W	2837	NSS3554OH321P	3121	"G" Option N/A	NSS3554OH321M 1674
150	NSS2954OH321W	2650	NSS2954OH321P	2915	"G" Option N/A	NSS2954OH321M 1630

2 Select Finish

- Click to view finishes
- WAC
 - WIC
 - WHC
 - WOC
 - WEC
 - WAM
 - WCM
 - WEW
 - WGW
 - WBW
 - WSW

- WNW
- WWP
- WWW
- WNF(Natural Oak on Flat Cut)
- WSF(Salted Oak on Flat Cut)
- WMF(Mocha Oak on Flat Cut)
- WLF(Lofty Oak on Flat Cut)

- TBCO
- TBSW
- TSTV
- TSMV
- TSLV
- TOBW
- WLO
- WMO
- WNO
- WSO

- MAC
- MOC
- MEC
- MGW
- MTW
- MSW
- MWL

3 Select Edge

Click to view edges

Edge
N/A

Edge
N/A

Edge
N/A

4 Select Hardware

Click to view details

Hardware
N/A

Hardware
N/A

Hardware
N/A

Product Features

- Finished top
- 1 Adjustable shelf per section standard
- Interior cabinet depth 12.5"
- Interior shelf depth 12"
- Silverluma doors w/ frosted acrylic inserts
- 5/8" grommet(s) included for task light wire management

Notes

- Unit has black back panel and is not designed for Open Plan use. Select OPB Option for Open Plan application.

Options

- Door
- D2: Door Lock - \$100 per door set
 - D6: Delete Doors - n/c
 - D9SC: Soft Close Door Hinges - \$20 per door
- Grommets (Vertical Surface)
- Standard Location - \$50 ea.
- Black Plastic Vertical Surface: TM50-C (Bottom Center)
- Non-Standard Location - \$95 ea.
- Black Plastic Vertical Surface: TM50-NS
- Interior Cabinet Lighting
- LEDPK starter kit includes Infeed, 1 Puck Interior Light and the ability to daisy chain up to 6 total Puck Lights
- LED Puck Starter Kit - \$310
 - PK: 1 LED Interior Light - \$130
- Task Lighting
- Overhead task light cord is located on the right facing side. If the opposite location is required please contact customer service.
- LT-LED24: 24" LED Task light - \$215
 - LT-LED48: 48" LED Task light - \$270
 - LT-LED60: 60" LED Task light - \$335
 - LT-LED72: 72" LED Task light - \$360
- Open Plan _ Finished Back
- OPB: "W"/"G" Style - Modify Unit for Open Plan Application - \$295
 - OPBM: "M" Style - Modify Unit for Open Plan Application - \$95
- Shelf
- GS14F: Replace Standard Shelves with Glass Shelves - \$90 per shelf
 - S714F: Heavy Duty Lumber 1" Shelves - \$80 per shelf ("M" Styles - n/a)

Overhead tackboard
Full width tackboards

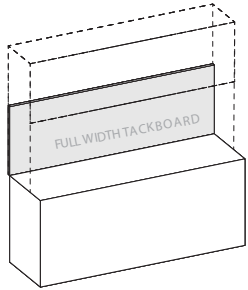

Product Width	Panel Dimension	SKU	COM	1	2	3	4	5	6	7	8	9	10	11/L1	12	13/L2
93	91 x .75 x 21	FTOC9121	379	480	531	582	633	684	735	786	837	888	939	990	1041	1143
87	85 x .75 x 21	FTOC8521	358	449	497	545	593	641	689	737	785	833	881	929	977	1073
83	81 x .75 x 21	FTOC8121	336	428	474	520	566	612	658	704	750	796	842	888	934	1026
76	74 x .75 x 21	FTOC7421	309	392	435	478	521	564	607	650	693	736	779	822	865	951
70	68 x .75 x 21	FTOC6821	282	361	401	441	481	521	561	601	641	681	721	761	801	881
64	62 x .75 x 21	FTOC6221	256	330	366	402	438	474	510	546	582	618	654	690	726	798
58	56 x .75 x 21	FTOC5621	234	299	331	363	395	427	459	491	523	555	587	619	651	715
47	45 x .75 x 21	FTOC4521	187	242	269	296	323	350	377	404	431	458	485	512	539	593
35	33 x .75 x 21	FTOC3321	141	180	200	220	240	260	280	300	320	340	360	380	400	440
29	27 x .75 x 21	FTOC2721	112	149	166	183	200	217	234	251	268	285	302	319	336	370

Standard Features

- Constructed of .5" thick fiberboard
- Fabric is precisely aligned and fitted to the tackboard
- Adhered to the rigid hardboard with staples
- Hung with Z-Strip mounting system

Notes

- Fabric Tack Panels are raised 3" from bottom edge when TM50 grommet is ordered

Overhead tackboard
Half width tackboards

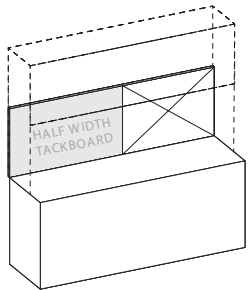

Product Width	Panel Dimension	SKU	COM	1	2	3	4	5	6	7	8	9	10	11/L1	12	13/L2
93 Half Width	45.5 x .75 x 21	FTOC4521	189	240	266	292	318	344	370	396	422	448	474	500	526	578
87 Half Width	42.5 x .75 x 21	FTOC4221	179	225	249	273	297	321	345	369	393	417	441	465	489	537
83 Half Width	40.5 x .75 x 21	FTOC4021	168	214	237	260	283	306	329	352	375	398	421	444	467	513
76 Half Width	37 x .75 x 21	FTOC3721	155	196	217	238	259	280	301	322	343	364	385	406	427	469
70 Half Width	34 x .75 x 21	FTOC3421	141	180	200	220	240	260	280	300	320	340	360	380	400	440
64 Half Width	31 x .75 x 21	FTOC3121	128	165	183	201	219	237	255	273	291	309	327	345	363	399

Standard Features

- Constructed of .5" thick fiberboard
- Fabric is precisely aligned and fitted to the tackboard
- Adhered to the rigid hardboard with staples
- Hung with Z-Strip mounting system

Notes

- Half width tackboards can be specified and combined with a Veneer Panel, Marker Board, or Glass Board. See "Half Width" items under product width.
- Specify right or left facing tackboard
- Fabric Tack Panels are raised 3" from bottom edge when TM50 grommet is ordered.

Overhead dry marker board
Full width dry marker board

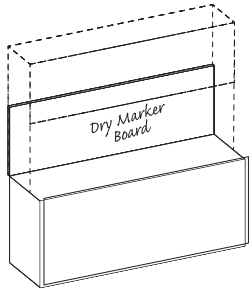

Product Width	Panel Dimension	SKU	List
93	91 x .5 x 21	DMOC9121	1136
87	85 x .5 x 21	DMOC8521	1061
83	81 x .5 x 21	DMOC8121	1011
76	74 x .5 x 21	DMOC7421	924
70	68 x .5 x 21	DMOC6821	849
64	62 x .5 x 21	DMOC6221	774
58	56 x .5 x 21	DMOC5621	699
47	45 x .5 x 21	DMOC4521	587
35	33 x .5 x 21	DMOC3321	437
29	27 x .5 x 21	DMOC2721	337

Standard Features

- Dry marker panel has edge trim molding
- Standard magnetic surface
- Hung with Z-Strip mounting system

Overhead dry marker board
Half width dry marker board

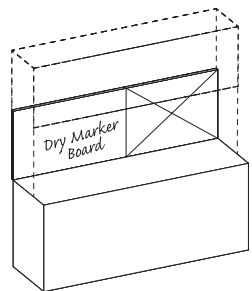

Product Width	Panel Dimension	SKU	List
93 Half Width	45.5 x .5 x 21	DMOC4521	555
87 Half Width	42.5 x .5 x 21	DMOC4221	518
83 Half Width	40.5 x .5 x 21	DMOC4021	493
76 Half Width	37 x .5 x 21	DMOC3721	449
70 Half Width	34 x .5 x 21	DMOC3421	437
64 Half Width	31 x .5 x 21	DMOC3121	374

Standard Features

- Dry marker panel has edge trim molding
- Standard magnetic surface
- Hung with Z-Strip mounting system

Notes

- Half width dry marker boards can be specified and combined with a Tackboard, Veneer Panel, or Glass Board. See "Half Width" items under product width.
- Specify right or left facing dry marker board

Overhead glassboard
Full width glassboard

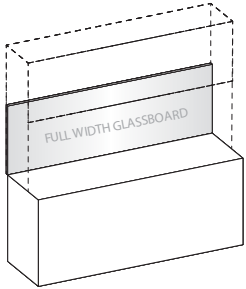

Product Width	Panel Dimension	SKU	List
93	91 x .5 x 21	GBOC9121	2382
87	85 x .5 x 21	GBOC8521	2236
83	81 x .5 x 21	GBOC8121	2138
76	74 x .5 x 21	GBOC7421	1969
70	68 x .5 x 21	GBOC6821	1822
64	62 x .5 x 21	GBOC6221	1676
58	56 x .5 x 21	GBOC5621	1531
47	45 x .5 x 21	GBOC4521	1264
35	33 x .5 x 21	GBOC3321	972
29	27 x .5 x 21	GBOC2721	826

Standard Features

- 4 mm tempered glass
- Use glass cleaner or alcohol to clean
- Standard dry erase markers may be used

Notes

- Earth magnets are required to hold items securely in place
- Hung with Z-Strip mounting system
- Use glass cleaner or alcohol to clean
- Standard dry erase markers may be used

Overhead glassboard
Half width glassboard

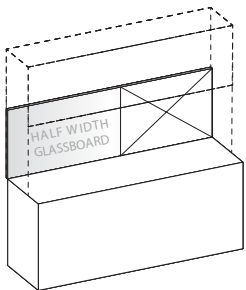

Product Width	Panel Dimension	SKU	List
93 Half Width	45.5 x .5 x 21	GBOC4521	1251
87 Half Width	42.5 x .5 x 21	GBOC4221	1178
83 Half Width	40.5 x .5 x 21	GBOC4021	1129
76 Half Width	37 x .5 x 21	GBOC3721	985
70 Half Width	34 x .5 x 21	GBOC3421	972
64 Half Width	31 x .5 x 21	GBOC3121	899

Standard Features

- 4 mm tempered glass
- Hung with Z-Strip mounting system

Notes

- Half width glassboards can be specified and combined with a Tackboard, Veneer panel, Marker Board or . See "Half Width" items under product width.
- Specify right or left facing glassboard
- Use glass cleaner or alcohol to clean
- Standard dry erase markers may be used
- Earth magnets are required to hold items securely in place

NOT SO square office

Single Height Wall Hung Overheads

Panel Doors

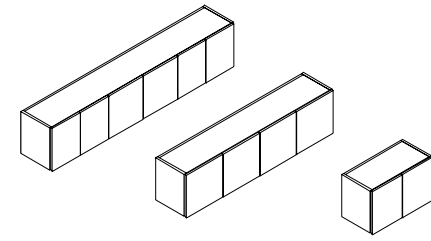

[Click here to view statement of line](#)

1 Select Model

w" x d" x h"	Weight
6 Door / 3 Section	
93 x 14 x 18	240
87 x 14 x 18	225
4 Door / 2 Section	
83 x 14 x 18	210
76 x 14 x 18	195
70 x 14 x 18	180
64 x 14 x 18	160
58 x 14 x 18	135
47 x 14 x 18	125
2 Door / 1 Section	
35 x 14 x 18	75
29 x 14 x 18	65

	Standard Veneer Top Standard Veneer Chassis		Premium Veneer Top Premium Veneer Chassis		High Pressure Laminate Top Veneer Chassis	Thermally Fused Laminate Top Thermally Fused Laminate Chassis	
WAC			TBCO			MAC	
WIC			TBSV		"G" Option N/A	MOC	
WHC			TSTV		"G" Option N/A	MEC	
WOC			TSMV		"G" Option N/A	MGW	
WEC			TSLV		"G" Option N/A	MTW	
WAM			TOBV		"G" Option N/A	MSW	
WCM			WLO		"G" Option N/A	MWL	
WEW			WMO		"G" Option N/A		
WGW			WNO		"G" Option N/A		
WBW			WSO				
WSW							
			Edge			Edge	
			N/A			N/A	
			Hardware			Hardware	
			N/A			N/A	

2 Select Finish

[Click to view finishes](#)

WAC	WNW
WIC	WWP
WHC	WWW
WOC	WNF(Natural Oak on Flat Cut)
WEC	WSF(Salted Oak on Flat Cut)
WAM	WMF(Mocha Oak on Flat Cut)
WCM	WLF(Lofty Oak on Flat Cut)
WEW	
WGW	
WBW	
WSW	

3 Select Edge

[Click to view edges](#)

Edge
N/A

4 Select Hardware

[Click to view details](#)

Hardware
N/A

Product Features

- Finished top
- Interior cabinet depth 12"
- Mounting wall rail included
- Panel doors with concealed finger pull

Notes

- The DARRAN wall mounted cabinet(or shelf) must be hung on a weight-bearing wall. The suitability of the wall supporting the wall mounted cabinet, and the installation and maintenance of the wall-mounted cabinet, is the sole responsibility of the customer. Failure to correctly install and/or exceed the loaded weight capacity of this product may cause it to fall, resulting in damage to the product, adjacent property and/or bodily injury.

Options

Door

- D2: Door Lock - \$100 per door set
- D6: Delete Doors - n/c
- D9SC: Soft Close Door Hinges - \$20 per door
- WPD3061: Designer White - \$80 per door

Interior Cabinet Lighting

- LEDPK starter kit includes Infeed, 1 Puck Interior Light and the ability to daisy chain up to 6 total Puck Lights
- LED Puck Starter Kit - \$310
- PK: 1 LED Interior Light - \$130

Task Lighting

- Overhead task light cord is located on the right facing side. If the opposite location is required please contact customer service.
- LT-LED24: 24" LED Task light - \$215
- LT-LED48: 48" LED Task light - \$270
- LT-LED60: 60" LED Task light - \$335
- LT-LED72: 72" LED Task light - \$360

NOT SO square office
Single Height Wall Hung Overheads
Silverluma Frame / Doors

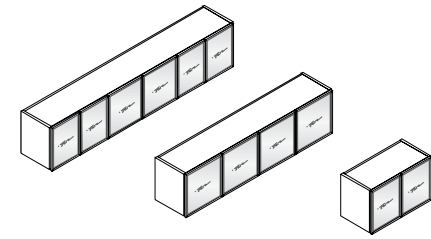

[Click here to view statement of line](#)

1 Select Model

- w" x d" x h"
 6 Door / 3 Section
 93 x 15 x 18
 87 x 15 x 18
 4 Door / 2 Section
 83 x 15 x 18
 76 x 15 x 18
 70 x 15 x 18
 64 x 15 x 18
 58 x 15 x 18
 47 x 15 x 18
 2 Door / 1 Section
 35 x 15 x 18
 29 x 15 x 18

Weight	Standard Veneer Top Standard Veneer Chassis		Premium Veneer Top Premium Veneer Chassis		High Pressure Laminate Top Veneer Chassis	Thermally Fused Laminate Top Thermally Fused Laminate Chassis	
		NSS9318WH331W	4818	NSS9318WH331P	5300	"G" Option N/A	NSS9318WH331M
240	NSS8718WH331W	4727	NSS8718WH331P	5199	"G" Option N/A	NSS8718WH331M	3359
	NSS8318WH331W	4625	NSS8318WH331P	5087	"G" Option N/A	NSS8318WH331M	2586
210	NSS7618WH331W	4562	NSS7618WH331P	5019	"G" Option N/A	NSS7618WH331M	2422
195	NSS7018WH331W	3810	NSS7018WH331P	4190	"G" Option N/A	NSS7018WH331M	2258
180	NSS6418WH331W	3688	NSS6418WH331P	4058	"G" Option N/A	NSS6418WH331M	2200
160	NSS5818WH331W	3574	NSS5818WH331P	3933	"G" Option N/A	NSS5818WH331M	2142
135	NSS4718WH331W	2735	NSS4718WH331P	3009	"G" Option N/A	NSS4718WH331M	2063
125	NSS3518WH331W	2085	NSS3518WH331P	2294	"G" Option N/A	NSS3518WH331M	1363
75	NSS2918WH331W	1992	NSS2918WH331P	2190	"G" Option N/A	NSS2918WH331M	1312
65							

2 Select Finish

- Click to view finishes
 WAC
 WIC
 WHC
 WOC
 WEC
 WAM
 WCM
 WEW
 WGW
 WBW
 WSW

- WNW
 WWP
 WWW
 WNF(Natural Oak on Flat Cut)
 WSF(Salted Oak on Flat Cut)
 WMF(Mocha Oak on Flat Cut)
 WLF(Lofty Oak on Flat Cut)

- TBCO
 TBSW
 TSTV
 TSMV
 TSLV
 TOBW
 WLO
 WMO
 WNO
 WSO

- MAC
 MOC
 MEC
 MGW
 MTW
 MSW
 MWL

3 Select Edge

Click to view edges

Edge
 N/A

Edge
 N/A

Edge
 N/A

4 Select Hardware

Click to view details

Hardware
 N/A

Hardware
 N/A

Hardware
 N/A

Product Features

- Finished top
- Interior cabinet depth 12"
- Mounting wall rail included
- Silverluma doors w/ frosted acrylic inserts

Notes

- The DARRAN wall mounted cabinet(or shelf) must be hung on a weight-bearing wall. The suitability of the wall supporting the wall mounted cabinet, and the installation and maintenance of the wall-mounted cabinet, is the sole responsibility of the customer. Failure to correctly install and/or exceed the loaded weight capacity of this product may cause it to fall, resulting in damage to the product, adjacent property and/or bodily injury.

Options

- Door
 - D2: Door Lock - \$100 per door set
 - D6: Delete Doors - n/c
 - D9SC: Soft Close Door Hinges - \$20 per door

Interior Cabinet Lighting

- LEDPK starter kit includes Infeed, 1 Puck Interior Light and the ability to daisy chain up to 6 total Puck Lights
 - LED Puck Starter Kit - \$310
 - PK: 1 LED Interior Light - \$130

Task Lighting

- Overhead task light cord is located on the right facing side. If the opposite location is required please contact customer service.
 - LT-LED24: 24" LED Task light - \$215
 - LT-LED48: 48" LED Task light - \$270
 - LT-LED60: 60" LED Task light - \$335
 - LT-LED72: 72" LED Task light - \$360

NOT SO square office

Single Height Wall Hung Overheads

Open Storage Cabinet

[Click here to view statement of line](#)

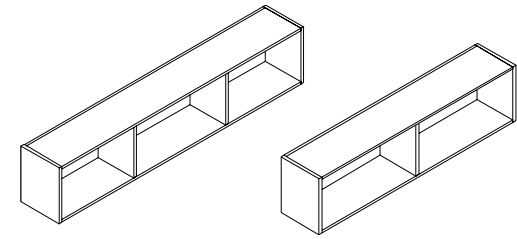

1 Select Model

w" x d" x h"
3 Section
93 x 14 x 18
87 x 14 x 18
83 x 14 x 18
76 x 14 x 18
2 Section
70 x 14 x 18
64 x 14 x 18
58 x 14 x 18
47 x 14 x 18
1 Section
35 x 14 x 18
29 x 14 x 18

Weight	Standard Veneer Top Standard Veneer Chassis		Premium Veneer Top Premium Veneer Chassis		High Pressure Laminate Top Veneer Chassis	Thermally Fused Laminate Top Thermally Fused Laminate Chassis	
		NSS9318WH332W	3925	NSS9318WH332P	4318	"G" Option N/A	NSS9318WH332M
225	NSS8718WH332W	3889	NSS8718WH332P	4278	"G" Option N/A	NSS8718WH332M	2383
210	NSS8318WH332W	3852	NSS8318WH332P	4238	"G" Option N/A	NSS8318WH332M	1787
200	NSS7618WH332W	3810	NSS7618WH332P	4190	"G" Option N/A	NSS7618WH332M	1695
185	NSS7018WH332W	3116	NSS7018WH332P	3428	"G" Option N/A	NSS7018WH332M	1607
170	NSS6418WH332W	3067	NSS6418WH332P	3374	"G" Option N/A	NSS6418WH332M	1555
150	NSS5818WH332W	3024	NSS5818WH332P	3327	"G" Option N/A	NSS5818WH332M	1494
125	NSS4718WH332W	2258	NSS4718WH332P	2485	"G" Option N/A	NSS4718WH332M	1409
115	NSS3518WH332W	1697	NSS3518WH332P	1868	"G" Option N/A	NSS3518WH332M	1051
60	NSS2918WH332W	1679	NSS2918WH332P	1846	"G" Option N/A	NSS2918WH332M	1002
50							

2 Select Finish

[Click to view finishes](#)

WAC	WNW	TBCO	MAC
WIC	WWP	TBSW	MOC
WHC	WWW	TSTV	MEC
WOC	WNF(Natural Oak	TSMV	MGW
WEC	on Flat Cut)	TSLV	MTW
WAM	WSF(Salted Oak	TOBW	MSW
WCM	on Flat Cut)	WLO	MWL
WEW	WMF(Mocha Oak	WMO	
WGW	on Flat Cut)	WNO	
WBW	WLF(Lofty Oak on	WSO	
WSW	Flat Cut)		

3 Select Edge

[Click to view edges](#)

Edge
N/A

Edge
N/A

Edge
N/A

4 Select Hardware

[Click to view details](#)

Hardware
N/A

Hardware
N/A

Hardware
N/A

Product Features

- Finished top
- Interior cabinet depth 12"
- Mounting wall rail included

Notes

- The DARRAN wall mounted cabinet(or shelf) must be hung on a weight-bearing wall. The suitability of the wall supporting the wall mounted cabinet, and the installation and maintenance of the wall-mounted cabinet, is the sole responsibility of the customer. Failure to correctly install and/or exceed the loaded weight capacity of this product may cause it to fall, resulting in damage to the product, adjacent property and/or bodily injury.
- Sliding doors will not pass each other

Options

Sliding Door

- SLD17LD: Laminate Door - \$205 per door
- SLD17FD: SilverLuma / Frost Door ("W", "M" only) - \$365 per door
- SLD17WD: Wood Door - \$260 per door

Interior Cabinet Lighting

- LEDPK starter kit includes Infeed, 1 Puck Interior Light and the ability to daisy chain up to 6 total Puck Lights
- LED Puck Starter Kit - \$310
- PK: 1 LED Interior Light - \$130

Task Lighting

- Overhead task light cord is located on the right facing side. If the opposite location is required please contact customer service.
- LT-LED24: 24" LED Task light - \$215
- LT-LED48: 48" LED Task light - \$270
- LT-LED60: 60" LED Task light - \$335
- LT-LED72: 72" LED Task light - \$360

NOT SO square office
 Double Height Wall Hung Overheads
 Panel Doors

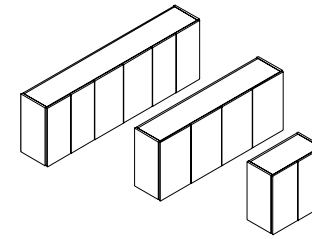

[Click here to view statement of line](#)

1 Select Model

w" x d" x h"

6 Door / 3 Section	265
93 x 14 x 29	250
87 x 14 x 29	235
4 Door / 2 Section	220
83 x 14 x 29	200
70 x 14 x 29	180
64 x 14 x 29	180
58 x 14 x 29	85
2 Door / 1 Section	75
35 x 14 x 29	
29 x 14 x 29	

Weight	Standard Veneer Top Standard Veneer Chassis		Premium Veneer Top Premium Veneer Chassis		High Pressure Laminate Top Veneer Chassis	Thermally Fused Laminate Top Thermally Fused Laminate Chassis	
		NSS9329WH330W	4955	NSS9329WH330P	5450	"G" Option N/A	NSS9329WH330M
	NSS8729WH330W	4877	NSS8729WH330P	5364	"G" Option N/A	NSS8729WH330M	3524
	NSS8329WH330W	4805	NSS8329WH330P	5285	"G" Option N/A	NSS8329WH330M	2607
	NSS7029WH330W	4053	NSS7029WH330P	4458	"G" Option N/A	NSS7029WH330M	2472
	NSS6429WH330W	4018	NSS6429WH330P	4420	"G" Option N/A	NSS6429WH330M	2418
	NSS5829WH330W	3938	NSS5829WH330P	4333	"G" Option N/A	NSS5829WH330M	2320
	NSS3529WH330W	2128	NSS3529WH330P	2341	"G" Option N/A	NSS3529WH330M	1664
	NSS2929WH330W	2078	NSS2929WH330P	2287	"G" Option N/A	NSS2929WH330M	1612

2 Select Finish

Click to view finishes

WAC	WNW
WIC	WWP
WHC	WWW
WOC	WNF(Natural Oak on Flat Cut)
WEC	WSF(Salted Oak on Flat Cut)
WAM	WMF(Mocha Oak on Flat Cut)
WCM	WLF(Lofty Oak on Flat Cut)
WEW	WSO
WGW	
WBW	
WSW	

TBCO	MAC
TBSW	MOC
TSTV	MEC
TSMV	MGW
TSLV	MTW
TOBW	MSW
WLO	MWL
WMO	
WNO	
WSO	

3 Select Edge

Click to view edges

Edge	Edge	Edge
N/A	N/A	N/A

Hardware	Hardware	Hardware
N/A	N/A	N/A

4 Select Hardware

Product Features

- 1 Adjustable shelf per section standard
- Black painted top
- Interior cabinet depth 12"
- Interior shelf depth 11.5"
- Mounting rails included
- Panel doors with concealed finger pull

Notes

- The DARRAN wall mounted cabinet(or shelf) must be hung on a weight-bearing wall. The suitability of the wall supporting the wall mounted cabinet, and the installation and maintenance of the wall-mounted cabinet, is the sole responsibility of the customer. Failure to correctly install and/or exceed the loaded weight capacity of this product may cause it to fall, resulting in damage to the product, adjacent property and/or bodily injury.

Options

- Door
- D2: Door Lock - \$100 per door set
 - D6: Delete Doors - n/c
 - D9SC: Soft Close Door Hinges - \$20 per door
 - WPD3061: Designer White - \$80 per door
- Interior Cabinet Lighting
- LEDPK starter kit includes Infeed, 1 Puck Interior Light and the ability to daisy chain up to 6 total Puck Lights
- LED Puck Starter Kit - \$310
 - PK: 1 LED Interior Light - \$130
- Task Lighting
- Overhead task light cord is located on the right facing side. If the opposite location is required please contact customer service.
- LT-LED24: 24" LED Task light - \$215
 - LT-LED48: 48" LED Task light - \$270
 - LT-LED60: 60" LED Task light - \$335
 - LT-LED72: 72" LED Task light - \$360
- Shelf
- S714F: Heavy Duty Lumber 1" Shelves - \$80 per shelf ("M" Styles - n/a)

NOT SO square office
 Double Height Wall Hung Overheads
 Silverluma Frame / Doors

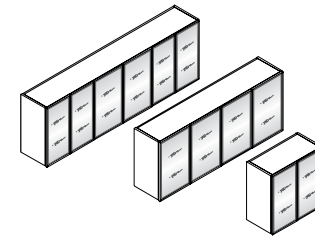

[Click here to view statement of line](#)

1 Select Model

w" x d" x h"

6 Door / 3 Section	93 x 14 x 29	265
87 x 14 x 29	250	
4 Door / 2 Section	70 x 14 x 29	220
64 x 14 x 29	200	
58 x 14 x 29	180	
2 Door / 1 Section	35 x 14 x 29	85
29 x 14 x 29	75	

Weight

	Standard Veneer Top Standard Veneer Chassis		Premium Veneer Top Premium Veneer Chassis		High Pressure Laminate Top Veneer Chassis	Thermally Fused Laminate Top Thermally Fused Laminate Chassis	
	NSS9329WH331W	6121	NSS9329WH331P	6734	"G" Option N/A	NSS9329WH331M	4556
	NSS8729WH331W	5936	NSS8729WH331P	6530	"G" Option N/A	NSS8729WH331M	4393
	NSS7029WH331W	4863	NSS7029WH331P	5349	"G" Option N/A	NSS7029WH331M	2801
	NSS6429WH331W	4733	NSS6429WH331P	5207	"G" Option N/A	NSS6429WH331M	2997
	NSS5829WH331W	4549	NSS5829WH331P	5004	"G" Option N/A	NSS5829WH331M	2902
	NSS3529WH331W	2578	NSS3529WH331P	2837	"G" Option N/A	NSS3529WH331M	1944
	NSS2929WH331W	2437	NSS2929WH331P	2680	"G" Option N/A	NSS2929WH331M	1901

2 Select Finish

[Click to view finishes](#)

WAC	WNW
WIC	WWP
WHC	WWW
WOC	WNF(Natural Oak on Flat Cut)
WEC	WSF(Salted Oak on Flat Cut)
WAM	WCM
WCM	WME
WEW	WMO
WGW	WNO
WBW	WLF(Lofty Oak on Flat Cut)
WSW	WSO

TBCO
TBSW
TSTV
TSMV
TSLV
TOBW
WLO
WMO
WNO
WSO

MAC
MOC
MEC
MGW
MTW
MSW
MWL

3 Select Edge

[Click to view edges](#)

Edge
N/A

Edge
N/A

Edge
N/A

4 Select Hardware

[Click to view details](#)

Hardware
N/A

Hardware
N/A

Hardware
N/A

Product Features

- Black painted top
- Interior cabinet depth 12"
- Interior shelf depth 11.5"
- Mounting rails included
- Silverluma doors w/ frosted acrylic inserts

Notes

- 1 Adjustable Shelf per section
- The DARRAN wall mounted cabinet(or shelf) must be hung on a weight-bearing wall. The suitability of the wall supporting the wall mounted cabinet, and the installation and maintenance of the wall-mounted cabinet, is the sole responsibility of the customer. Failure to correctly install and/or exceed the loaded weight capacity of this product may cause it to fall, resulting in damage to the product, adjacent property and/or bodily injury.

Options

Door

- D2: Door Lock - \$100 per door set
- D6: Delete Doors - n/c
- D95C: Soft Close Door Hinges - \$20 per door

Interior Cabinet Lighting

- LEDPK starter kit includes Infeed, 1 Puck Interior Light and the ability to daisy chain up to 6 total Puck Lights
- LED Puck Starter Kit - \$310
- PK: 1 LED Interior Light - \$130

Task Lighting

- Overhead task light cord is located on the right facing side. If the opposite location is required please contact customer service.
- LT-LED24: 24" LED Task light - \$215
- LT-LED48: 48" LED Task light - \$270
- LT-LED60: 60" LED Task light - \$335
- LT-LED72: 72" LED Task light - \$360

Shelf

- GS14F: Replace Standard Shelves with Glass Shelves - \$90 per shelf
- S714F: Heavy Duty Lumber 1" Shelves - \$80 per shelf ("M" Styles - n/a)

NOT SO square office
Double Height Wall Hung Overheads
Open Storage Cabinet

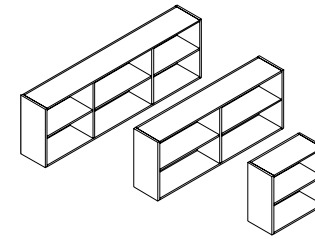

[Click here to view statement of line](#)

1 Select Model

w" x d" x h"

	Weight
3 Section	
93 x 14 x 29	215
87 x 14 x 29	200
83 x 14 x 29	190
2 Section	
70 x 14 x 29	180
64 x 14 x 29	170
58 x 14 x 29	150
1 Section	
35 x 14 x 29	70
29 x 14 x 29	60

	Standard Veneer Top Standard Veneer Chassis	Premium Veneer Top Premium Veneer Chassis	High Pressure Laminate Top Veneer Chassis	Thermally Fused Laminate Top Thermally Fused Laminate Chassis
NSS9329WH332W 4309	NSS9329WH332P 4741	"G" Option N/A	NSS9329WH332M 2861	
NSS8729WH332W 4229	NSS8729WH332P 4652	"G" Option N/A	NSS8729WH332M 2702	
NSS8329WH332W 4151	NSS8329WH332P 4567	"G" Option N/A	NSS8329WH332M 2055	
NSS7029WH332W 3546	NSS7029WH332P 3902	"G" Option N/A	NSS7029WH332M 1910	
NSS6429WH332W 3478	NSS6429WH332P 3825	"G" Option N/A	NSS6429WH332M 1872	
NSS5829WH332W 3396	NSS5829WH332P 3736	"G" Option N/A	NSS5829WH332M 1780	
NSS3529WH332W 1896	NSS3529WH332P 2086	"G" Option N/A	NSS3529WH332M 1371	
NSS2929WH332W 1853	NSS2929WH332P 2039	"G" Option N/A	NSS2929WH332M 1324	

2 Select Finish

[Click to view finishes](#)

WAC	WNW
WIC	WWP
WHC	WWW
WOC	WNF(Natural Oak on Flat Cut)
WEC	WSF(Salted Oak on Flat Cut)
WAM	WSF(Salted Oak on Flat Cut)
WCM	WMF(Mocha Oak on Flat Cut)
WEW	WLF(Lofty Oak on Flat Cut)
WGW	WSW
WBW	
WSW	

TBCO
TBSW
TSTV
TSMV
TSLV
TOBW
WLO
WMO
WNO
WSO

MAC
MOC
MEC
MGW
MTW
MSW
MWL

3 Select Edge

[Click to view edges](#)

Edge
N/A

Edge
N/A

Edge
N/A

4 Select Hardware

[Click to view details](#)

Hardware
N/A

Hardware
N/A

Hardware
N/A

Product Features

- 1 Adjustable shelf per section
- Black painted top
- Interior cabinet depth 12"
- Interior shelf depth 11.5"
- Mounting rails included

Notes

- 1 or 2 Optional Doors Available
- Sliding doors will not pass each other
- The DARRAN wall mounted cabinet(or shelf) must be hung on a weight-bearing wall. The suitability of the wall supporting the wall mounted cabinet, and the installation and maintenance of the wall-mounted cabinet, is the sole responsibility of the customer. Failure to correctly install and/or exceed the loaded weight capacity of this product may cause it to fall, resulting in damage to the product, adjacent property and/or bodily injury.

Options

Sliding Door

- SLD29LD: Laminate Door - \$260 per door
- SLD29FD: SilverLuma / Frost Door ("W", "M" only) - \$415 per door
- SLD29WD: Wood Door - \$310 per door

Task Lighting

Overhead task light cord is located on the right facing side. If the opposite location is required please contact customer service.

- LT-LED24: 24" LED Task light - \$215
- LT-LED48: 48" LED Task light - \$270
- LT-LED60: 60" LED Task light - \$335
- LT-LED72: 72" LED Task light - \$360

Shelf

- GS14F: Replace Standard Shelves with Glass Shelves - \$90 per shelf
- S714F: Heavy Duty Lumber 1" Shelves - \$80 per shelf ("M" Styles - n/a)

Wall hung tackboards
Full width tackboards

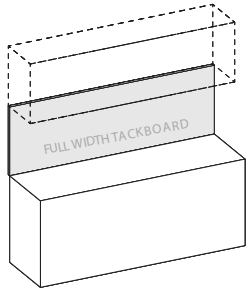

Product Width	Panel Dimension	SKU	COM	1	2	3	4	5	6	7	8	9	10	11/L1	12	13/L2
93"	93 x .75 x 24	FTWH9324	465	576	627	678	729	780	831	882	933	984	1035	1086	1137	1239
87"	87 x .75 x 24	FTWH8724	448	539	587	635	683	731	779	827	875	923	971	1019	1067	1163
83"	83 x .75 x 24	FTWH8324	422	514	560	606	652	698	744	790	836	882	928	974	1020	1112
76"	76 x .75 x 24	FTWH7624	388	471	514	557	600	643	686	729	772	815	858	901	944	1030
70"	70 x .75 x 24	FTWH7024	355	434	474	514	554	594	634	674	714	754	794	834	874	954
64"	64 x .75 x 24	FTWH6424	322	396	432	468	504	540	576	612	648	684	720	756	792	864
58"	58 x .75 x 24	FTWH5824	294	359	391	423	455	487	519	551	583	615	647	679	711	775
47"	47 x .75 x 24	FTWH4724	236	291	318	345	372	399	426	453	480	507	534	561	588	642
35"	35 x .75 x 24	FTWH3524	176	217	237	257	277	297	317	337	357	377	397	417	437	477
29"	29 x .75 x 24	FTWH2924	142	179	196	213	230	247	264	281	298	315	332	349	366	400

Standard Features

- Constructed of .5" thick fiberboard
- Fabric is precisely aligned and fitted to the tackboard
- Adhered to the rigid hardboard with staples

Wall hung tackboards
Half width tackboards

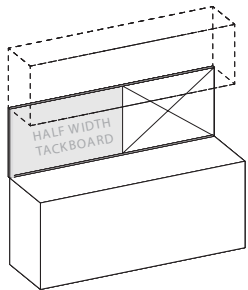

Product Width	Panel Dimension	SKU	COM	1	2	3	4	5	6	7	8	9	10	11/L1	12	13/L2
93 Half Width	46.5 x .75 x 24	FTWH4624	233	288	313	338	363	388	413	438	463	488	513	538	563	613
87 Half Width	43.5 x .75 x 24	FTWH4324	225	270	294	318	342	366	390	414	438	462	486	510	534	582
83 Half Width	41.5 x .75 x 24	FTWH4124	211	257	280	303	326	349	372	395	418	441	464	487	510	556
76 Half Width	38 x .75 x 24	FTWH3824	194	235	256	277	298	319	340	361	382	403	424	445	466	508
70 Half Width	35 x .75 x 24	FTWH3524	178	217	237	257	277	297	317	337	357	377	397	417	437	477
64 Half Width	32 x .75 x 24	FTWH3224	161	198	216	234	252	270	288	306	324	342	360	378	396	432

Standard Features

- Constructed of .5" thick fiberboard
- Fabric is precisely aligned and fitted to the tackboard
- Adhered to the rigid hardboard with staples
- Hung with Z-Strip mounting system

Notes

- Half width tackboards can be specified and combined with a Veneer Panel, Marker Board, or Glass Board. See "Half Width" items under product width.
- Specify right or left facing tackboard

DARRAN®

Wall hung dry marker board
Full width dry marker board

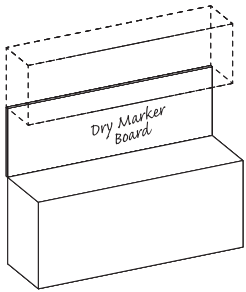

Product Width	Panel Dimension	SKU	List
93	93 x .75 x 24	DMWH9324	1161
87	87 x .75 x 24	DMWH8724	1086
83	83 x .75 x 24	DMWH8324	1023
76	76 x .75 x 24	DMWH7624	948
70	70 x .75 x 24	DMWH7024	874
64	64 x .75 x 24	DMWH6424	799
58	58 x .75 x 24	DMWH5824	724
47	47 x .75 x 24	DMWH4724	587
35	35 x .75 x 24	DMWH3524	437
29	29 x .75 x 24	DMWH2924	362

Standard Features

- Dry marker panel has edge trim molding
- Standard magnetic surface
- Hung with Z-Strip mounting system

Wall hung dry marker board
Half width dry marker board

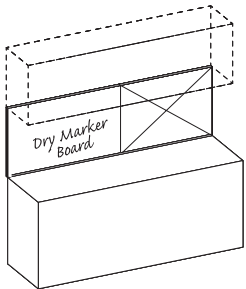

Product Width	Panel Dimension	SKU	List
93 Half Width	46.5 x .75 x 24	DMWH4624	580
87 Half Width	43.5 x .75 x 24	DMWH4324	543
83 Half Width	41.5 x .75 x 24	DMWH4124	518
76 Half Width	38 x .75 x 24	DMWH3824	474
70 Half Width	35 x .75 x 24	DMWH3524	437
64 Half Width	32 x .75 x 24	DMWH3224	399

Standard Features

- Dry marker panel has edge trim molding
- Standard magnetic surface
- Hung with Z-Strip mounting system

Notes

- Half width dry marker boards can be specified and combined with a Tackboard, Veneer Panel, or Glass Board. See "Half Width" items under product width.
- Specify right or left facing dry marker board

Wall hung veneer panel
Full width veneer panel

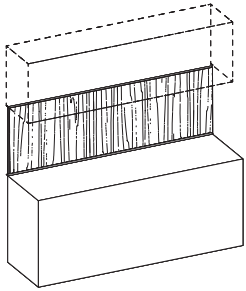

Product Width	Panel Dimension	SKU	List
93	93 x .75 x 24	VPWH9324	967
87	87 x .75 x 24	VPWH8724	905
83	83 x .75 x 24	VPWH8324	853
76	76 x .75 x 24	VPWH7624	790
70	70 x .75 x 24	VPWH7024	728
64	64 x .75 x 24	VPWH6424	666
58	58 x .75 x 24	VPWH5824	603
47	47 x .75 x 24	VPWH4724	489
35	35 x .75 x 24	VPWH3524	364
29	29 x .75 x 24	VPWH2924	302

Standard Features

- Veneer edges

Notes

- Vertical wire channels on back for task light cords
- Steel mounting wall channel is recessed for flush mounting
- Hung with Z-Strip mounting system
- Can be used with or without overhead cabinet
- Required for other accessory panels

Wall hung veneer panel
Hang width veneer panel

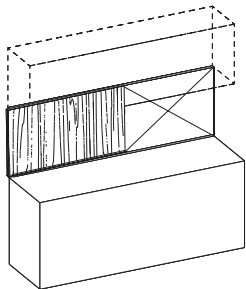

Product Width	Panel Dimension	SKU	List
93 Half Width	46.5 x .75 x 24	VPWH4624	484
87 Half Width	43.5 x .75 x 24	VPWH4324	452
83 Half Width	41.5 x .75 x 24	VPWH4124	432
76 Half Width	38 x .75 x 24	VPWH3824	395
70 Half Width	35 x .75 x 24	VPWH3524	364
64 Half Width	32 x .75 x 24	VPWH3224	333

Standard Features

- Veneer edges
- Vertical wire channels on back for task light cords
- Steel mounting wall channel is recessed for flush mounting
- Hung with Z-Strip mounting system

Notes

- Half width veneer panels can be specified and combined with a Tackboard, Marker Board, or Glass Board. See "Half Width" items under product width.
- Specify right or left facing veneer panel
- Can be used with or without overhead cabinet
- Required for other accessory panels

Wall hung glassboard
Full width glassboards

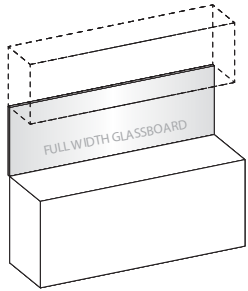

Product Width	Panel Dimension	SKU	List
93	93 x .75 x 24	GBWH9324	2753
87	87 x .75 x 24	GBWH8724	2586
83	83 x .75 x 24	GBWH8324	2475
76	76 x .75 x 24	GBWH7624	2281
70	70 x .75 x 24	GBWH7024	2114
64	64 x .75 x 24	GBWH6424	1948
58	58 x .75 x 24	GBWH5824	1780
47	47 x .75 x 24	GBWH4724	1476
35	35 x .75 x 24	GBWH3524	1142
29	29 x .75 x 24	GBWH2924	976

Standard Features

- 4 mm tempered glass

Notes

- Earth magnets are required to hold items securely in place
- Hung with Z-Strip mounting system
- Use glass cleaner or alcohol to clean
- Standard dry erase markers may be used

Wall hung glassboard
Half width glassboards

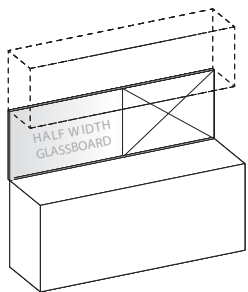

Product Width	Panel Dimension	SKU	List
93 Half Width	46.5 x .75 x 24	GBWH4624	1461
87 Half Width	43.5 x .75 x 24	GBWH4324	1378
83 Half Width	41.5 x .75 x 24	GBWH4124	1323
76 Half Width	38 x .75 x 24	GBWH3824	1232
70 Half Width	35 x .75 x 24	GBWH3524	1142
64 Half Width	32 x .75 x 24	GBWH3224	1059

Standard Features

- 4 mm tempered glass
- Hung with Z-Strip mounting system

Notes

- Half width glassboards can be specified and combined with a Tackboard, Veneer panel, Marker Board. See "Half Width" items under product width.
- Must specify Right or left facing glassboard
- Use glass cleaner or alcohol to clean
- Standard dry erase markers may be used
- Earth magnets are required to hold items securely in place

NOT SO square office
Single Height Wall Hung Overheads
Open Endless Shelf Single Height

[Click here to view statement of line](#)

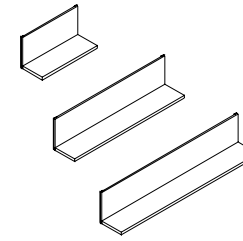

1 Select Model

w" x d" x h"	Weight
105 x 9 x 18	110
99 x 9 x 18	105
93 x 9 x 18	100
87 x 9 x 18	95
83 x 9 x 18	90
76 x 9 x 18	85
70 x 9 x 18	80
64 x 9 x 18	75
58 x 9 x 18	70
48 x 9 x 18	50
35 x 9 x 18	35
29 x 9 x 18	30

Standard Veneer Top Standard Veneer Chassis		Premium Veneer Top Premium Veneer Chassis		High Pressure Laminate Top Veneer Chassis	Thermally Fused Laminate Top Thermally Fused Laminate Chassis
NSS10518WH336W	3892	NSS10518WH336P	3777	"G" Option N/A	"M" Option N/A
NSS9918WH336W	3670	NSS9918WH336P	3561	"G" Option N/A	"M" Option N/A
NSS9318WH336W	3453	NSS9318WH336P	3798	"G" Option N/A	NSS9318WH336M 2092
NSS8718WH336W	3236	NSS8718WH336P	3561	"G" Option N/A	NSS8718WH336M 2014
NSS8318WH336W	3093	NSS8318WH336P	3403	"G" Option N/A	NSS8318WH336M 1949
NSS7618WH336W	2842	NSS7618WH336P	3127	"G" Option N/A	NSS7618WH336M 1887
NSS7018WH336W	2629	NSS7018WH336P	2892	"G" Option N/A	NSS7018WH336M 1843
NSS6418WH336W	2414	NSS6418WH336P	2655	"G" Option N/A	NSS6418WH336M 1728
NSS5818WH336W	2200	NSS5818WH336P	2420	"G" Option N/A	NSS5818WH336M 1647
NSS4818WH336W	1906	NSS4818WH336P	2098	"G" Option N/A	NSS4818WH336M 1333
NSS3518WH336W	1463	NSS3518WH336P	1609	"G" Option N/A	NSS3518WH336M 1095
NSS2918WH336W	1249	NSS2918WH336P	1375	"G" Option N/A	NSS2918WH336M 1010
WAC	WNW	TBCO			MAC
WIC	WWP	TBSW			MOC
WHC	WWW	TSTV			MEC
WOC	WNF(Natural Oak	TSMV			MGW
WEC	on Flat Cut)	TSLV			MTW
WAM	WSF(Salted Oak	TOBW			MSW
WCM	on Flat Cut)	WLO			MWL
WEW	WMF(Mocha Oak	WMO			
WGW	on Flat Cut)	WNO			
WBW	WLF(Lofty Oak on	WSO			
WSW	Flat Cut)				
Edge N/A		Edge N/A			Edge N/A
Hardware N/A		Hardware N/A			Hardware N/A

Product Features

- Mounting rails included

Notes

- The DARRAN wall mounted cabinet(or shelf) must be hung on a weight-bearing wall. The suitability of the wall supporting the wall mounted cabinet, and the installation and maintenance of the wall-mounted cabinet, is the sole responsibility of the customer. Failure to correctly install and/or exceed the loaded weight capacity of this product may cause it to fall, resulting in damage to the product, adjacent property and/or bodily injury.

- Max load per inch is 3lbs

Options

Task Lighting

Overhead task light cord is located on the right facing side. If the opposite location is required please contact customer service.

- LT-LED24: 24" LED Task light - \$215

- LT-LED48: 48" LED Task light - \$270

- LT-LED60: 60" LED Task light - \$335

- LT-LED72: 72" LED Task light - \$360

2 Select Finish

[Click to view finishes](#)

WAC	WNW
WIC	WWP
WHC	WWW
WOC	WNF(Natural Oak
WEC	on Flat Cut)
WAM	WSF(Salted Oak
WCM	on Flat Cut)
WEW	WMF(Mocha Oak
WGW	on Flat Cut)
WBW	WLF(Lofty Oak on
WSW	Flat Cut)

3 Select Edge

[Click to view edges](#)

Edge
N/A

Edge
N/A

Edge
N/A

4 Select Hardware

[Click to view details](#)

Hardware
N/A

Hardware
N/A

Hardware
N/A

NOT SO square office

Double Height Wall Hung Overheads

Open Endless Shelf Double Height

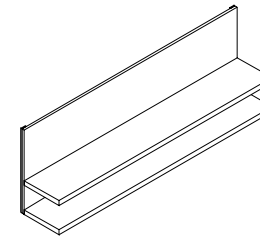

[Click here to view statement of line](#)

1 Select Model

w" x d" x h"	Weight	Standard Veneer Top Standard Veneer Chassis		Premium Veneer Top Premium Veneer Chassis		High Pressure Laminate Top Veneer Chassis	Thermally Fused Laminate Top Thermally Fused Laminate Chassis
		105 x 9 x 29	180	NSS10529WH336W	4620	NSS10518WH336P	5082
99 x 9 x 29	170	NSS9929WH336W	4354	NSS9918WH336P	4791	"G" Option N/A	"M" Option N/A
93 x 9 x 29	160	NSS9329WH336W	4089	NSS9329WH336P	4499	"G" Option N/A	NSS9329WH336M 2464
87 x 9 x 29	150	NSS8729WH336W	3833	NSS8729WH336P	4217	"G" Option N/A	NSS8729WH336M 2380
83 x 9 x 29	140	NSS8329WH336W	3661	NSS8329WH336P	4027	"G" Option N/A	NSS8329WH336M 2296
76 x 9 x 29	130	NSS7629WH336W	3359	NSS7629WH336P	3696	"G" Option N/A	NSS7629WH336M 2216
70 x 9 x 29	120	NSS7029WH336W	3102	NSS7029WH336P	3412	"G" Option N/A	NSS7029WH336M 2162
64 x 9 x 29	110	NSS6429WH336W	2842	NSS6429WH336P	3127	"G" Option N/A	NSS6429WH336M 2026
58 x 9 x 29	100	NSS5829WH336W	2586	NSS5829WH336P	2845	"G" Option N/A	NSS5829WH336M 1930
48 x 9 x 29	80	NSS4829WH336W	2234	NSS4829WH336P	2458	"G" Option N/A	NSS4829WH336M 1554
35 x 9 x 29	60	NSS3529WH336W	1706	NSS3529WH336P	1876	"G" Option N/A	NSS3529WH336M 1267
29 x 9 x 29	50	NSS2929WH336W	1450	NSS2929WH336P	1594	"G" Option N/A	NSS2929WH336M 1164

Product Features

- Mounting rails included

Notes

- The DARRAN wall mounted cabinet(or shelf) must be hung on a weight-bearing wall. The suitability of the wall supporting the wall mounted cabinet, and the installation and maintenance of the wall-mounted cabinet, is the sole responsibility of the customer. Failure to correctly install and/or exceed the loaded weight capacity of this product may cause it to fall, resulting in damage to the product, adjacent property and/or bodily injury.

- Max load per inch is 6lbs

Options

Task Lighting

Overhead task light cord is located on the right facing side. If the opposite location is required please contact customer service.

- LT-LED24: 24" LED Task light - \$215
- LT-LED48: 48" LED Task light - \$270
- LT-LED60: 60" LED Task light - \$335
- LT-LED72: 72" LED Task light - \$360

2 Select Finish

[Click to view finishes](#)

WAC	WNW	TBCO	MAC
WIC	WWP	TBSW	MOC
WHC	WWW	TSTV	MEC
WOC	WNF(Natural Oak	TSMV	MGW
WEC	on Flat Cut)	TSLV	MTW
WAM	WSF(Salted Oak	TOBW	MSW
WCM	on Flat Cut)	WLO	MWL
WEW	WMF(Mocha Oak	WMO	
WGW	on Flat Cut)	WNO	
WBW	WLF(Lofty Oak on	WSO	
WSW	Flat Cut)		

3 Select Edge

[Click to view edges](#)

Edge N/A	Edge N/A	Edge N/A
-------------	-------------	-------------

4 Select Hardware

[Click to view details](#)

Hardware N/A	Hardware N/A	Hardware N/A
-----------------	-----------------	-----------------

NOT SO square office

Freestanding Half Towers
Wardrobe / Storage

[Click here to view statement of line](#)

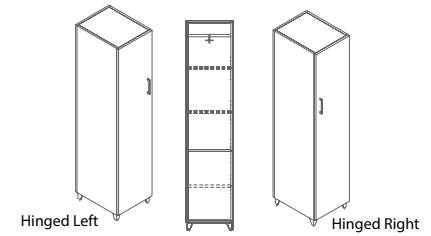

1 Select Model

w" x d" x h"
Door Hinged Left
16 x 21 x 83
16 x 21 x 71
Door Hinged Right
16 x 21 x 83
16 x 21 x 71

Weight	Standard Veneer Top Standard Veneer Chassis		Premium Veneer Top Premium Veneer Chassis		High Pressure Laminate Top Veneer Chassis	Thermally Fused Laminate Top Thermally Fused Laminate Chassis
	180	NSS1683TW283W	4097	NSS1683TW283P	4506	"G" Option N/A
165	NSS1671TW283W	3896	NSS1671TW283P	4286	"G" Option N/A	NSS1671TW283M 1736
180	NSS1683TW284W	4097	NSS1683TW284P	4506	"G" Option N/A	NSS1683TW284M 1961
165	NSS1671TW284W	3896	NSS1671TW284P	4286	"G" Option N/A	NSS1671TW284M 1736

Product Features

- Interior cabinet depth 12.5"
- Standard fixed shelf with 3 adjustable shelves
- Standard Silver Feet (optional White, Black)
- "W" styles - 71" H units finished top, 83" H units black painted top

Notes

- Flush cut credenza ends when ganging towers to credenza
- Unit has black back panel and is not designed for Open Plan use. Select OPB Option for Open Plan application.

Options

Door

- D2: Door Lock - \$100 per door set
- D6: Delete Doors - n/c
- D9SC: Soft Close Door Hinges - \$20 per door
- WPD3061: Designer White - \$80 per door

Feet

- D8: Delete feet (extend fronts to floor) - n/c

Open Plan _ Finished Back

- OPB: "W" "G" Style - Modify Unit for Open Plan Application - \$295
- OPBM: "M" Style - Modify Unit for Open Plan Application - \$95

Premium Finish Option

- MFB: Black Metal Finish - \$30 per foot
- MFW: White Metal Finish - \$30 per foot

2 Select Finish

Click to view finishes

WAC
WIC
WHC
WOC
WEC
WAM
WCM
WEW
WGW
WBW
WSW

WNW
WWP
WWW
WNF(Natural Oak on Flat Cut)
WSF(Salted Oak on Flat Cut)
WMF(Mocha Oak on Flat Cut)
WLF(Lofty Oak on Flat Cut)

TBCO
TBSW
TSTV
TSMV
TSLV
TOBW
WLO
WMO
WNO
WSO

MAC
MOC
MEC
MGW
MTW
MSW
MWL

3 Select Edge

Click to view edges

Edge
N/A

Edge
N/A

Edge
N/A

4 Select Hardware

Click to view details



NOT SO square office

Freestanding Half Towers
Storage / File

[Click here to view statement of line](#)

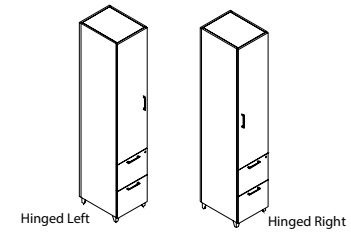

1 Select Model

w" x d" x h"
Door Hinged Left
16 x 21 x 83
16 x 21 x 71
Door Hinged Right
16 x 21 x 83
16 x 21 x 71

Weight	Standard Veneer Top Standard Veneer Chassis		Premium Veneer Top Premium Veneer Chassis		High Pressure Laminate Top Veneer Chassis		Thermally Fused Laminate Top Thermally Fused Laminate Chassis	
	190	NSS1683TW291W	4268	NSS1683TW291P	4696	"G" Option N/A	NSS1683TW291M	2366
175	NSS1671TW291W	4061	NSS1671TW291P	4468	"G" Option N/A	NSS1671TW291M	2142	
190	NSS1683TW292W	4268	NSS1683TW292P	4696	"G" Option N/A	NSS1683TW292M	2366	
175	NSS1671TW292W	4061	NSS1671TW292P	4468	"G" Option N/A	NSS1671TW292M	2142	

Product Features

- Interior cabinet depth 12.5"
- Soft close suspension drawer(s)
- Standard fixed shelf with 2 adjustable shelves (71")
- Standard fixed shelf with 3 adjustable shelves (83")
- Standard Silver Feet (optional White, Black)
- "W" styles - 71" H units finished top, 83" H units black painted top

Notes

- Flush cut credenza ends when ganging towers to credenza
- Unit has black back panel and is not designed for Open Plan use. Select OPB Option for Open Plan application.

Options

- Door**
- D2: Door Lock - \$100 per door set
 - D6: Delete Doors - n/c
 - D9SC: Soft Close Door Hinges - \$20 per door
 - WPD3061: Designer White - \$80 per door
- Drawer**
- P6: Modify File/File to Box/Box/File - \$55 per pedestal
 - P33: Wood Drawer Upgrade - \$45 per drawer
- Feet**
- D8: Delete feet (extend fronts to floor) - n/c
- Open Plan _ Finished Back**
- OPB: "W"/"G" Style - Modify Unit for Open Plan Application - \$295
 - OPBM: "M" Style - Modify Unit for Open Plan Application - \$95
- Premium Finish Option**
- Specify foot Metal Finish color - \$160 per unit. Contact customer service
 - MFB: Black, MFW: White

2 Select Finish

[Click to view finishes](#)

Metal Finish

MFS Silver. Additional Metal Finishes are available, options

WAC	WNW	TBCO	MAC
WIC	WWP	TBSW	MOC
WHC	WWW	TSTV	MEC
WOC	WNF(Natural Oak on Flat Cut)	TSMV	MGW
WEC	WSF(Salted Oak on Flat Cut)	TSLV	MTW
WAM	WSF(Salted Oak on Flat Cut)	TOBW	MSW
WCM	WMF(Mocha Oak on Flat Cut)	WLO	MWL
WEW	WLF(Lofty Oak on Flat Cut)	WMO	
WGW		WNO	
WBW		WSO	
WSW			

3 Select Edge

[Click to view edges](#)

Edge
N/A

Edge
N/A

Edge
N/A

4 Select Hardware

[Click to view details](#)

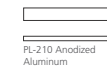

NOT SO square office

Freestanding Towers
Storage / File- Mini-Wardrobe

[Click here to view statement of line](#)

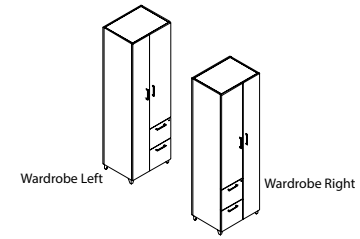

1 Select Model

w" x d" x h"
Wardrobe Left
26 x 21 x 83
26 x 21 x 71
Wardrobe Right
26 x 21 x 83
26 x 21 x 71

Weight	Standard Veneer Top Standard Veneer Chassis		Premium Veneer Top Premium Veneer Chassis		High Pressure Laminate Top Veneer Chassis	Thermally Fused Laminate Top Thermally Fused Laminate Chassis
265	NSS2683TW293W	5126	NSS2683TW293P	5640	"G" Option N/A	NSS2683TW293M 2710
240	NSS2671TW293W	4897	NSS2671TW293P	5387	"G" Option N/A	NSS2671TW293M 2413
265	NSS2683TW294W	5126	NSS2683TW294P	5640	"G" Option N/A	NSS2683TW294M 2710
240	NSS2671TW294W	4897	NSS2671TW294P	5387	"G" Option N/A	NSS2671TW294M 2413

Product Features

- Interior cabinet depth 12.5"
- Full extension drawers
- Locking drawers
- Soft close suspension drawer(s)
- Standard fixed shelf with 2 adjustable shelves (71")
- Standard fixed shelf with 3 adjustable shelves (83")
- Standard Silver Feet (optional White, Black)
- "W" styles - 71" H units finished top, 83" H units black painted top

Notes

- Flush cut credenza ends when ganging towers to credenza

Options

- Door
- D2: Door Lock - \$100 per door set
 - D6: Delete Doors - n/c
 - D9SC: Soft Close Door Hinges - \$20 per door
 - WPD3061: Designer White - \$80 per door
- Drawer
- P6: Modify File/File to Box/Box/File - \$55 per pedestal
 - P33: Wood Drawer Upgrade - \$45 per drawer
- Feet
- D8: Delete feet (extend fronts to floor) - n/c
- Open Plan _ Finished Back
- OPB: "W"/"G" Style - Modify Unit for Open Plan Application - \$295
 - OPBM: "M" Style - Modify Unit for Open Plan Application - \$95
- Premium Finish Option
- Specify foot Metal Finish color - \$160 per unit. Contact customer service
 - MFB: Black, MFW: White

2 Select Finish

Click to view finishes

WAC	WNW	TBCO	MAC
WIC	WWP	TBSW	MOC
WHC	WWW	TSTV	MEC
WOC	WNF(Natural Oak on Flat Cut)	TSMV	MGW
WEC	WSF(Salted Oak on Flat Cut)	TSLV	MTW
WAM	WSF(Salted Oak on Flat Cut)	TOBW	MSW
WCM	WMF(Mocha Oak on Flat Cut)	WLO	MWL
WEW	WMF(Mocha Oak on Flat Cut)	WMO	
WGW	WLF(Lofty Oak on Flat Cut)	WNO	
WBW	WLF(Lofty Oak on Flat Cut)	WSO	
WSW	WLF(Lofty Oak on Flat Cut)		

3 Select Edge

Click to view edges

Edge
N/A

Edge
N/A

Edge
N/A

4 Select Hardware

Click to view details

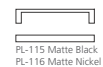

NOT SO square office

Freestanding Towers
Storage / File Full Tower

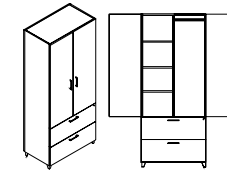

[Click here to view statement of line](#)

1 Select Model

w" x d" x h"
83" Height
35 x 21 x 83
29 x 21 x 83
71" Height
35 x 21 x 71
29 x 21 x 71

Weight	Standard Veneer Top Standard Veneer Chassis		Premium Veneer Top Premium Veneer Chassis		High Pressure Laminate Top Veneer Chassis	Thermally Fused Laminate Top Thermally Fused Laminate Chassis
350	NSS3583TW281W	5805	NSS3583TW281P	6388	"G" Option N/A	NSS3583TW281M 3075
325	NSS2983TW281W	5513	NSS2983TW281P	6065	"G" Option N/A	NSS2983TW281M 3019
325	NSS3571TW281W	5184	NSS3571TW281P	5703	"G" Option N/A	NSS3571TW281M 2777
295	NSS2971TW281W	4928	NSS2971TW281P	5420	"G" Option N/A	NSS2971TW281M 2712

Product Features

- 71" has 2 adj. shelves / 1 fixed shelf
- 83" has 3 adj. shelves / 1 fixed shelf
- Adjustable shelf per door section
- Full extension drawers
- Locking drawers
- Features ball bearing suspensions, suspensions are full extension
- Standard Silver Feet (optional White, Black)
- "W" styles - 71" H units finished top, 83" H units black painted top
- Wardrobe left, storage right

Notes

- Flush cut credenza ends when ganging towers to credenza
- Unit has black back panel and is not designed for Open Plan use. Select OPB Option for Open Plan application.

Options

- Door**
- D2: Door Lock - \$100 per door set
 - D6: Delete Doors - n/c
 - D95C: Soft Close Door Hinges - \$20 per door
 - WPD3061: Designer White - \$80 per door
- Drawer**
- P33: Wood Drawer Upgrade - \$45 per drawer
- Feet**
- D8: Delete feet (extend fronts to floor) - n/c
- Open Plan _ Finished Back**
- OPB: "W" "G" Style - Modify Unit for Open Plan Application - \$295
 - OPBM: "M" Style - Modify Unit for Open Plan Application - \$95
- Shelf**
- MOD300P: Delete Center Partition / Add 2 (71") or 3 (83") Full Width Adj. Shelves - \$295
- Premium Finish Option**
- Specify foot Metal Finish color - \$160 per unit. Contact customer service
 - MFB: Black, MFW: White

2 Select Finish

Click to view finishes

WAC	WNW	TBCO	MAC
WIC	WWP	TBSW	MOC
WHC	WWW	TSTV	MEC
WOC	WNF(Natural Oak on Flat Cut)	TSMV	MGW
WEC	WSF(Salted Oak on Flat Cut)	TSLV	MTW
WAM	WSM(Salted Oak on Flat Cut)	TOBW	MSW
WCM	WMM(Mocha Oak on Flat Cut)	WLO	MWL
WEW	WML(Mocha Oak on Flat Cut)	WMO	
WGW	WMLF(Lofty Oak on Flat Cut)	WNO	
WBW		WSO	
WSW			

3 Select Edge

Click to view edges

Edge
N/A

Edge
N/A

Edge
N/A

4 Select Hardware

Click to view details



NOT SO square office

Open Bookcases
Freestanding

[Click here to view statement of line](#)

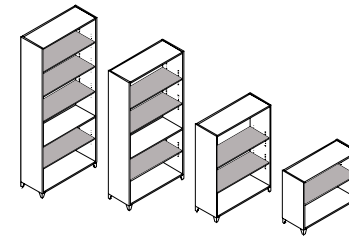

1 Select Model

w" x d" x h"	Weight
35" x 14 x 83	195
35" x 14 x 71	175
35" x 14 x 60	155
35" x 14 x 48	120
35" x 14 x 29	95
29" x 14 x 83	190
29" x 14 x 71	170
29" x 14 x 60	150
29" x 14 x 48	115
29" x 14 x 29	90

	Standard Veneer Top Standard Veneer Chassis		Premium Veneer Top Premium Veneer Chassis		High Pressure Laminate Top Veneer Chassis	Thermally Fused Laminate Top Thermally Fused Laminate Chassis
35" x 14 x 83	NSS3583BK250W	3952	NSS3583BK250P	4348	"G" Option N/A	NSS3583BK250M 1709
35" x 14 x 71	NSS3571BK250W	3560	NSS3571BK250P	3916	"G" Option N/A	NSS3571BK250M 1584
35" x 14 x 60	NSS3560BK250W	3167	NSS3560BK250P	3484	"G" Option N/A	NSS3560BK250M 1493
35" x 14 x 48	NSS3548BK250W	2158	NSS3548BK250P	2374	"G" Option N/A	NSS3548BK250M 1351
35" x 14 x 29	NSS3529BK250W	1916	NSS3529BK250P	2107	"G" Option N/A	NSS3529BK250M 1041
29" x 14 x 83	NSS2983BK250W	3673	NSS2983BK250P	4040	"G" Option N/A	NSS2983BK250M 1678
29" x 14 x 71	NSS2971BK250W	3308	NSS2971BK250P	3639	"G" Option N/A	NSS2971BK250M 1551
29" x 14 x 60	NSS2960BK250W	2944	NSS2960BK250P	3240	"G" Option N/A	NSS2960BK250M 1459
29" x 14 x 48	NSS2948BK250W	2007	NSS2948BK250P	2208	"G" Option N/A	NSS2948BK250M 1315
29" x 14 x 29	NSS2929BK250W	1778	NSS2929BK250P	1956	"G" Option N/A	NSS2929BK250M 991

2 Select Finish

Click to view finishes

Metal Finish

MFS Silver. Additional Metal Finishes are available, options

WAC	WNW	TBCO	MAC
WIC	WWP	TBSW	MOC
WHC	WWW	TSTV	MEC
WOC	WNF(Natural Oak on Flat Cut)	TSMV	MGW
WEC	WSF(Salted Oak on Flat Cut)	TSLV	MTW
WAM	WMF(Mocha Oak on Flat Cut)	TOBW	MSW
WCM	WLF(Lofty Oak on Flat Cut)	WLO	MWL
WEW		WMO	
WGW		WNO	
WBW		WSO	
WSW			

3 Select Edge

Click to view edges

Edge
N/A

Edge
N/A

Edge
N/A

4 Select Hardware

Click to view details

Hardware
N/A

Hardware
N/A

Hardware
N/A

Product Features

- 3/4" thick back
- Interior shelf depth 12"
- Metal legs standard
- Standard Silver Feet (optional White, Black)
- "W" styles - 29", 48", 60", and 71" H units finished top, 83" H units black painted top

Notes

- Adjustable shelves shaded in gray
- Unit has black back panel and is not designed for Open Plan use. Select OPB Option for Open Plan application.

Options

- Feet
- D8: Delete feet - n/c
- Interior Cabinet Lighting
- LEDPK starter kit includes Infeed, 1 Puck Interior Light and the ability to daisy chain up to 6 total Puck Lights
- LED Puck Starter Kit - \$310
- PK: 1 LED Interior Light - \$130
- Open Plan _ Finished Back
- OPB: "W" "G" Style - Modify Unit for Open Plan Application - \$295
- OPBM: "M" Style - Modify Unit for Open Plan Application - \$95
- Shelf
- GS14F: Replace Standard Shelves with Glass Shelves - \$90 per shelf
- S714F: Heavy Duty Lumber 1" Shelves - \$80 per shelf ("M" Styles - n/a)
- Premium Finish Option
- Specify foot Metal Finish color - \$160 per unit. Contact customer service
- MFB: Black, MFW: White

Interior drawer dimensions

UNIT DEPTH	DRAWER TYPE	OVERALL DIMENSIONS			INTERIOR DRAWER DIMENSIONS			NOTES
		W	D	H	W	D	H	
15-5/8" Letter	36" Box	13-1/8	19-11/16	4	12-1/8	18-11/16	3-7/16	Units less than 72"
	36" File	13-1/8	19-11/16	9-13/16	12-1/8	18-11/16	9-5/16	Units less than 72"
	30" Box	13-1/8	19-11/16	4	12-1/8	18-11/16	3-7/16	Units less than 72"
	30" File	13-1/8	19-11/16	9-13/16	12-1/8	18-11/16	9-5/16	Units less than 72"
	24" Box	13-1/8	16-1/16	4	12-1/8	15-1/16	3-7/16	Units less than 72"
	24" File	13-1/8	16-1/16	9-13/16	12-1/8	15-1/16	9-5/16	Units less than 72"
29" Lateral	24" Box	26-1/2	16-1/16	4	25-1/2	15-1/16	3-7/16	Workstation Credenzas less than 82"
	24" File	26-1/2	16-1/16	9-13/16	25-1/2	15-1/16	9-5/16	Workstation Credenzas less than 82"
31" Lateral	24" File	28-9/16	16-1/16	9-13/16	27-9/16	15-1/16	9-5/16	Multi-File Lateral File
35" Lateral	24" Box	32-1/2	16-1/16	4	31-1/2	15-1/16	3-7/16	Workstation Credenzas over 83"
	24" File	32-1/2	16-1/16	9-13/16	31-1/2	15-1/16	9-5/16	Workstation Credenzas over 83"
41" Lateral	24" File	38-1/2	16-1/16	9-13/16	37-1/2	15-1/16	9-5/16	Wood Drawer Only

Filing for 24" Depth Units

13" Wide File Drawer - 16" Deep

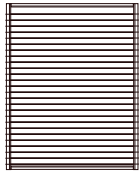

Letter Front to Back

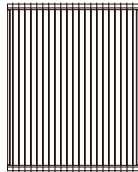

Legal Side to Side with File Rail

29" Lateral File Drawer

26-1/2" Wide File Drawer - 16-1/16" Deep

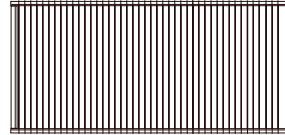

Legal Side to Side

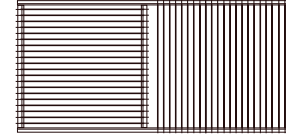

Legal Side to Side Letter Front to Back with File Rail



Letter Front to Back with File Rail

Filing for 30" & 36" Depth Units

13" Wide File Drawer - 20" Deep

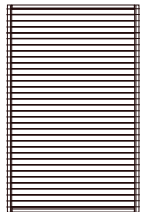

Letter Front to Back

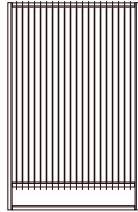

Legal Side to Side with File Rail

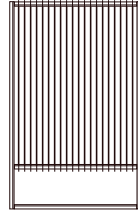

Letter Side to Side with File Rail

35" Lateral File Drawer

32-1/2" Wide File Drawer - 16-1/16" Deep

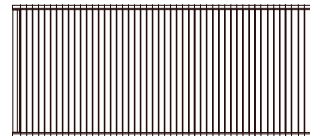

Legal Side to Side

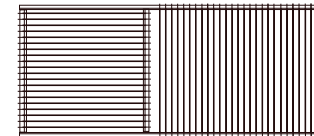

Legal Side to Side Letter Front to Back with File Rail

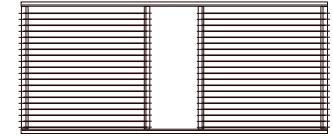

Letter Front to Back with File Rail



COMPUTER SUPPORT
single monitor arm

Style Number	List Price
MA1	280

Specifications

- Available in black or silver
- Desk clamp and mounting included
- Easy assembly and flexibility
- Elastic painting process for a durable and beautiful finish
- Gas spring tension adjustment for counter-balance height adjustment for monitors 1-8 KG
- Gas spring tested to 50,000 repetitions
- Hidden cable management



COMPUTER SUPPORT
double monitor arm

Style Number	List Price
MA2	450

Specifications

- Available in black or silver
- Desk clamp and mounting included
- Easy assembly and flexibility
- Elastic painting process for a durable and beautiful finish
- Gas spring tension adjustment for counter-balance height adjustment for monitors 1-8 KG
- Gas spring tested to 50,000 repetitions
- Hidden cable management



COMPUTER SUPPORT
triple monitor arm

Style Number	List Price
MA3	530

Specifications

- Available in black or silver
- Desk clamp and mounting included
- Easy assembly and flexibility
- Elastic painting process for a durable and beautiful finish
- Gas spring tension adjustment for counter-balance height adjustment for monitors 1-8 KG
- Gas spring tested to 50,000 repetitions
- Hidden cable management



COMPUTER SUPPORT
quadruple monitor arm

Style Number	List Price
MA4	705

Specifications

- Available in black
- Desk clamp and mounting included
- Easy assembly and flexibility
- Elastic painting process for a durable and beautiful finish
- Gas spring tension adjustment for counter-balance height adjustment for monitors 1-8 KG
- Gas spring tested to 50,000 repetitions
- Hidden cable management

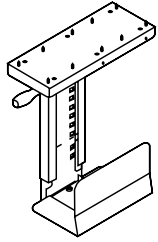

COMPUTER SUPPORT
cpu retractable cradle

Style Number	List Price
K18	205

Specifications

- Black Metal CPU Carriage
- Full 360° swivel capability allows easy access to rear of CPU for cables / wires
- Track allows 8- 1/2" extension
- Width Adjustment 5-1/2" to 9-1/4"
- Height adjustment 14- 5/8" to 20- 1/2"
- Black epoxy finish

Notes
- Factory Installed

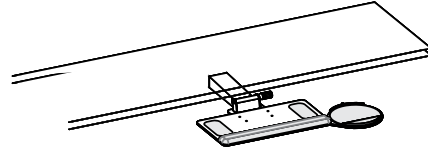

COMPUTER SUPPORT
articulating keyboard tray

Style Number	List Price
Factory Installed K28	390
Field Installed K28F	415

Specifications

- Adjusts effortlessly - A simple one-handed motion allows the keyboard to be repositioned instantly, without the use of locks or levers
- Encourages low-risk postures - Maximizes adjustability within a safe operating range.
- Will last a lifetime - Exceeds all applicable BIFMA Standards and comes with a lifetime guarantee.

Notes
- Available on: Freestanding Desk
- Factory Installed (standard)
- FIELD INSTALL - \$415



DOOR MODIFICATIONS
soft close door hinge

Style Number	List Price
D95C	20 Per door

Specifications

- Snap onto standard door hinge
- Requires (2) per door
- Max door height 43"
- Factory installed where specified
- Individually shipped for field installation

Notes
- Specify Each Item To Have Slow Close Feature

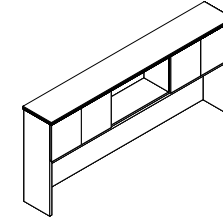

DOOR MODIFICATIONS
delete doors

Style Number	List Price
D6	N/C

Specifications

- Standard Door overheads and cabinets can have door deleted for open access. Modification of hinge rails and structural components are made face ready.

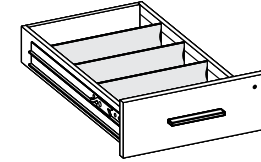
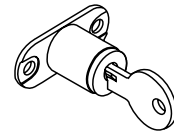
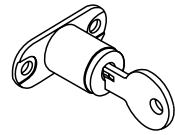
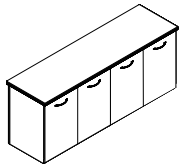

DOOR MODIFICATIONS
delete doors/replace black laminate shelf w/ finished shelf

Style Number	List Price
D6A	N/C

DOOR MODIFICATIONS
panel door lock

Style Number	List Price
D2	100 Per door set

DOOR MODIFICATIONS
glass door lock

Style Number	List Price
D2-G	205 Per door set

DRAWER OPTIONS
box drawer accessories

Style Number	List Price
Wood Drawer Dividers w/ Clips K-DIV	SET OF 3 - 30
Single Tray - Utility Tray K-Sut	35 ea.

Specifications

- Delete doors and replace black laminate shelf with finished shelf

Notes
- Available on: All Storage "W"/"G" Style Credenzas.

Specifications

- Door Locks - 1 Door w/ Lock, Other Door w/ Catch Latch
- Contact Customer Service regarding limited lock locations and keying.

Notes
- Available on: Panel Doors, Wood Frame Doors, and Silverluma doors

Specifications

- Door Locks - 1 Door w/ Lock, Other Door w/ Catch Latch
- Contact Customer Service regarding limited lock locations and keying.

Notes
- Available on: Glass Doors

Specifications

- K-DIV Extra Wood Drawer Dividers with Clips, Top Box drawers standard with 1 divider
- K-SUT Single Tray - Utility Tray, Specify Legal or Letter drawer width

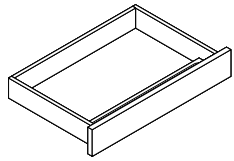

DRAWER OPTIONS
finished center drawer

Style Number	List Price
K31	205
Add Skirt Option K31-SK	310

Specifications

- Veneer drawer front finished to match unit W or G style veneer.
- Ball bearing smooth operation
- Drawer has lifetime guarantee
- Standard with matching wood grain pencil tray
- Laminate drawer front to match laminate unit (M style)

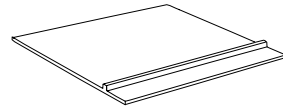

DRAWER OPTIONS - BOTTOM COVER
felt bottom center drawer insert liner

Style Number	List Price
K3	100

Specifications

- Inserts into center drawer and features divider for open pen and pencil storage. Removable for easy cleaning.
- Adds a luxurious touch to center drawers.
- Color: Dark Brown Coal

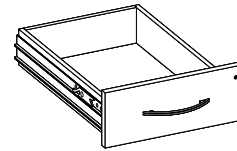

DRAWER OPTIONS - UPGRADE
wood drawer upgrade

Style Number	List Price
P33	45 Per drawer

Specifications

- Dowel joint construction
- Hardwood veneer multi-ply drawer
- UV finish
- 1/4" Wood veneer bottoms
- File drawer bottoms are five block reinforced for heavy weight capacity
- Lifetime guaranteed

GLASSBOARD ACCESSORIES
glassboard accessory kit

Style Number	List Price
GBKIT	290

Specifications

- 8 Earth magnets, 1 magnetic marker cup holder and 1 magnetic dry eraser

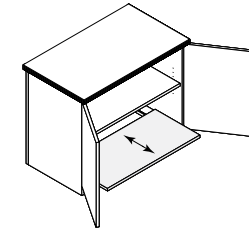
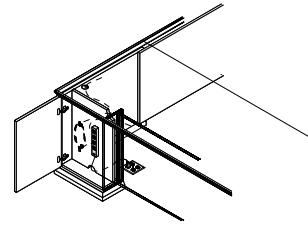
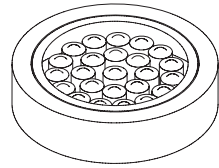

TASK LIGHTING
lt-led task light

Style Number	List Price
LT-LED24	215
LT-LED48	270
LT-LED60	335
LT-LED72	360

Specifications

- 6.5' Power cord. Switch with touch dimmer
- 36 LEDs per foot
- 4.6 Watts per foot
- 91 Lumens per watt
- Please note when ganging.
- Overhead tasklight cord is located on the right facing side. If the opposite location is required please contact customer service.

LIGHTING
led interior cabinet puck light

Style Number	List Price
Starter Kit	
LEDPK	310
1 LED Interior Puck Light	
PK	130

Specifications

- Starter kit includes Infeed, 1 Puck Interior Light and the ability to daisy chain up to 6 total Puck Lights
- (1) LED Puck Light with 30W power drive and switch
- Recessed fixture
- 12V linking cord 98"L
- Silver finish
- 50,000 hour life
- 2 watt per light

Notes

- Available on: Overhead/Tower Units with glass doors or no doors
- Power drive included, Light only

PEDESTAL MODIFICATIONS
breakfront pedestal with wire management cavity door

Style Number	List Price
PC10	100
Power Supply Cordset	
PD717	100

Specifications

- Hinged pedestal front door offers easy access for wire management
- Wire hooks provide wire coil storage
- Wire access openings allow access to floor, cabinets interior and kneespace
- Cabinet interior is black finish
- Top grommet is positioned over cavity for access ease
- (Power Strip Optional)

Notes

- Breakfront Chassis Only

PEDESTAL MODIFICATIONS
black laminate printer pullout bottom shelf

Style Number	List Price
PPOS	225

Specifications

- Black Laminate pullout shelf on suspension
- Black grommet
- Adjustable Shelf

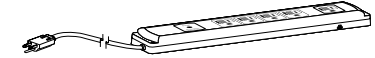
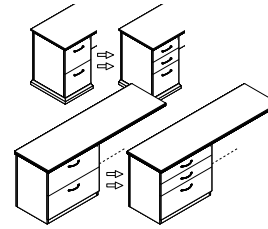
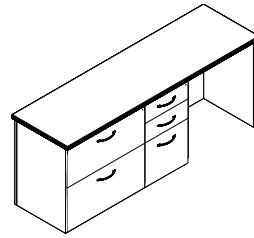
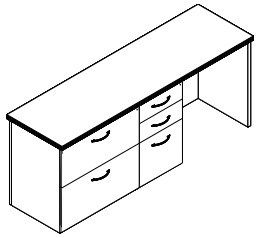

PEDESTAL MODIFICATIONS
add veneer kneespace cabinets - no base

Style Number	List Price
Add Box/Box/File or File/File P40W	910
Add Lateral File 29" W P41W	1025
Add Multi-File - 31"W P42W	1140
Add Storage With Doors 29"W P43W	1025
Add CPU /Printer Cabinet - Open P44W	1025

Specifications

- Multi-file specify Box/Box Left or Right

Notes
- Add additional Standard Cabinets To Kneespace Area.

PEDESTAL MODIFICATIONS
add melamine (TFL) kneespace cabinets - no base

Style Number	List Price
Add Box/Box/File or File/File P40M	720
Add Lateral File 29" W P41M	890
Add Multi-File - 31"W P42M	1005
Add Storage With Doors 29"W P43M	800
Add CPU /Printer Cabinet - Open P44M	915

Specifications

- Multi-file specify Box/Box Left or Right

Notes
- Available on: TFL products
- Add additional Standard Cabinets To Kneespace Area.

PEDESTAL MODIFICATIONS
modify drawer configurations

Style Number	List Price
File/File to Box/Box/File P6	55 Per ped
Box/Box/File to File/File P6	55 Per ped
Lateral File to 2 Box Drawers P8	100 Per ped

Specifications

- Modify File/File To Box/Box/File - Any Unit

POWER / DATA
power supply cordset

Style Number	List Price
PD717	100

Specifications

- SIZE: 10.75"L x 2.0"W x 1.06"H
- (5) Outlets w/ 10' cord
- Surge suppression (720 Joules)
- 15 Amp breaker
- Available on: Vertical Panels, Cabinet Interiors, and under tops

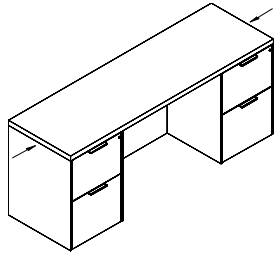

PRODUCT MODIFICATIONS
modify width - open kneespace

Style Number	List Price
MOD-1	125

Specifications

- Modify width down on any unit with an open kneespace: desk, workstation credenza, bridge, return

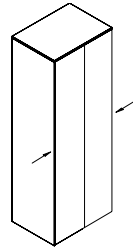

PRODUCT MODIFICATIONS
modify width - open/closed storage

Style Number	List Price
MOD-2	250

Specifications

- Modify width down on any unit with open or closed storage section: overheads, wall hung units, storage credenzas, towers

PRODUCT MODIFICATIONS
modify width - outside of mod-1, mod-2

Style Number	List Price
MOD-3	Contact for pricing

Specifications

- Width modification outside of MOD-1 & MOD-2

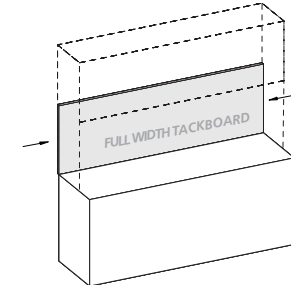

PRODUCT MODIFICATIONS
modify width - tackboard, veneer panel, or a glassboard

Style Number	List Price
MOD-4	50

Specifications

- Modify width down on tackboard, veneer panel, or a overhead glassboard

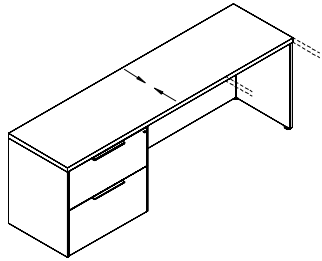

PRODUCT MODIFICATIONS
modify depth - decrease depth

Style Number	List Price
MOD-5	125

Specifications

- Modify depth down (minimum depth for a unit with drawers is 21"D)

Notes
- Ex. 24" to 21", 30" to 24", and 36" to 30"

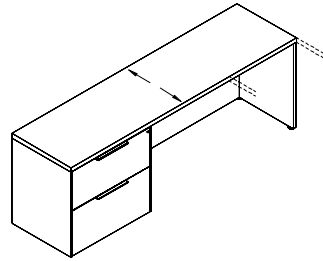

PRODUCT MODIFICATIONS
modify depth - increase depth

Style Number	List Price
MOD-6	Add 10%

Specifications

- Increase depth by no more than 6"

Notes
- Ex. 24" to 30", 30" to 36", and 36" to 42"
- Add 10% to the unit you want to increase the depth of by no more than 6"

PRODUCT MODIFICATIONS
modify height

Style Number	List Price
MOD-7	Contact for pricing

Specifications

- Modify height of a unit

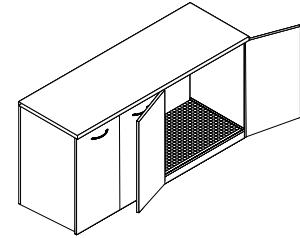

REFRIGERATOR MODIFICATION
refrigerator cabinet modification

Style Number	List Price
REF01	205

Specifications

- Open back cutout for venting
- Moisture sponge mat
- Contaminate ledge
- Contact customer service for maximum refrigerator size (Changes based on unit).

Notes
- Available on: 36" and 42" Storage Credenzas

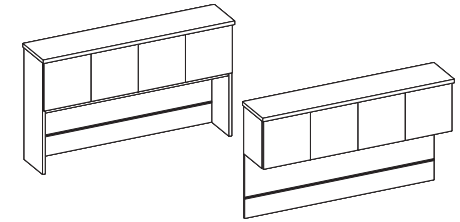
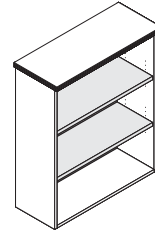
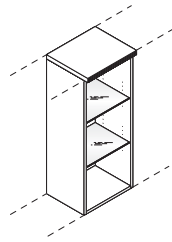
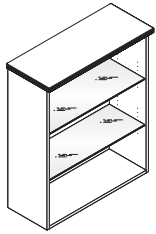

SHELF MODIFICATIONS

glass shelves - tempered full width
26" - 35"

Style Number	List Price
26"W - 35"W x 14"D Shelf GS14F	90

SHELF MODIFICATIONS

tempered glass shelves for half
cabinet 17- 1/2" widths

Style Number	List Price
14-1/2"W - 17- 1/2"W x 14"D Shelf GS14H	70 ea.

SHELF MODIFICATIONS

heavy duty solid wood bookcase
replacement shelves

Style Number	List Price
1" Wood Shelf 14" Deep S714F	80 ea.
1" Wood Shelf 24" Deep S714FX	160 ea.

TOOL CHANNEL ACCESSORIES
recessed aluminum tool channel

Style Number	List Price
ATB02	5 per 1"W

Specifications

- Glass Shelves Replace Wood Shelf In Open Or Glass Door Cabinet. Also Order Interior Cabinet Lighting.

Specifications

- Glass Shelves Replace Wood Shelf In Open Or Glass Door Cabinet. Also Order Interior Cabinet Lighting.

Notes

- Replace only adjustable shelves between cabinet light and fixed lower wood shelf.

Specifications

- 1" Solid Lumber Core Shelves Replace Standard 3/4" Plywood Adjustable And Fixed Shelves

Specifications

- Anodized aluminum finish
- Fully recessed
- Finish matches anodized aluminum accessories
- Can be specified with fabric tack surface mounted above channel

Notes

- If using tool channel with wallhung overhead, a veneer panel must be specified.



TOOL CHANNEL ACCESSORIES
iphone holder

Style Number	List Price
ATB31	125

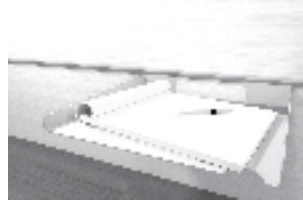

TOOL CHANNEL ACCESSORIES
large shelf

Style Number	List Price
ATB35	135

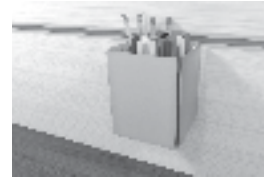

TOOL CHANNEL ACCESSORIES
pencil pen holder

Style Number	List Price
ATB38	120

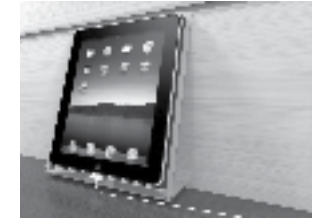

TOOL CHANNEL ACCESSORIES
tablet holder

Style Number	List Price
ATB30	145

Specifications

- For Console/Wall Hung Back Panels With Optional Tool Bar
- 18 Gauge Steel - Stamp Formed
- Silver Powderdercoat Finish
- 5" x 3 -3/4"W
- Non-slip Neoprene pad

Specifications

- 12"W x 10"D

Specifications

- For Console/Wall Hung Back Panels With Optional Tool Bar
- 18 Gauge Steel - Stamp Formed
- Silver Powderdercoat Finish
- 5"H x 4"W x 4"D

Specifications

- For Console/Wall Hung Back Panels With Optional Tool Bar
- 18 Gauge Steel - Stamp Formed
- Silver Powderdercoat Finish
- 10" x 8"W
- Non-slip Neoprene pad

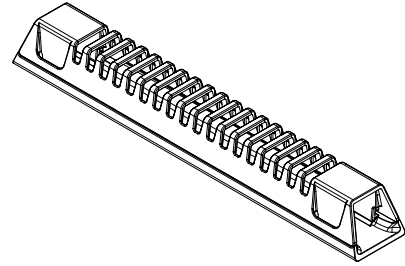
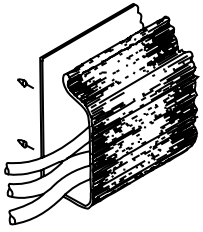

WIRE MANAGEMENT
horizontal j-channel wire management raceway

WIRE MANAGEMENT
horizontal wire management raceway

WIRE MANAGEMENT
horizontal u-channel wire management raceway

WIRE MANAGEMENT
coil wire manager

Style Number	List Price
W1	80 Per 4' section

Style Number	List Price
W21	35

Style Number	List Price
W2A	80 Per 4' section

Style Number	List Price
W18	160

Specifications

- 4' section for field installation.
- The "J" shape black thermoplastic wire raceway may be added to specified worksurface tops to provide concealed channeling of wires to and from worksurface grommets. For use in open kneespace areas, raceway is attachable to top of back panel with pan head screws. Interior dimensions are 1" x 1- 1/2" providing ample storage for multiple wires and excess cable. Front of raceway flexes out for easy cord insertion.

- Notes
- Units w/ Wire Channel Standard.
 - Field Installation

Specifications

- 10"W x 1.5"D x 1.25"H
- Grey Wire Manager (10.5")
- Power and data cables can be discretely housed and managed with the W21 Gray Wire Manager. This can be mounted in any location to metal frame or underside of conference tables and runs cables through a 1" channel from power module to hollow steel legs. This keeps cables organized under the table top. Release clips make it simple to snap on and off the Wire Manager for easy organization and access after attached to the table

- Notes
- Field installed

Specifications

- 4' section for field installation.

- Notes
- Units w/ Wire Channel Standard.
 - Field Installation

Specifications

- Weighted Base, Table attachment plate
- 39- 1/2" Length
- Black

- Notes
- Location

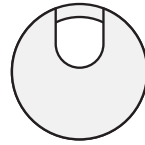
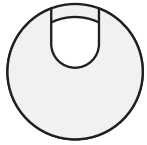

WIRE MANAGEMENT

standard location grommets - factory installed

Style Number	List Price
Standard Location Grommet	
Black	
TM30	50
Silver	
TM31	50
Antique Brass	
TM33	50
White	
TM34	50

WIRE MANAGEMENT

non-standard location grommets - factory installed

Style Number	List Price
Non-Standard Location Grommet	
Black	
TM30 -NS	95
Silver	
TM31 -NS	95
Antique Brass	
TM33 -NS	95
White	
TM34 -NS	95

WIRE MANAGEMENT

black plastic vertical surface grommets - factory installed

Style Number	List Price
Standard Location Grommet	
TM50-C	50
Non-Standard Location Grommet	
TM50-NS	95

Specifications

- 1 -5/8" Metal Grommet

Notes

- *Units w/ Grommets Standard Are Noted Under Standard Features. Grommets Match Pull Finish - Standard (Unless Specified Otherwise)

Specifications

- 1 -5/8" Metal Grommet

Notes

- *Units w/ Grommets Standard Are Noted Under Standard Features. Grommets Match Pull Finish - Standard (Unless Specified Otherwise)

Specifications

- 2 " Black Plastic Grommet

Notes

- Standard Location is Bottom Center

Aircharge wireless charging grommet

Style Number	List Price
 ACWG WIRELESS GROMMET	\$195

Specifications

- > When used with GROVE Tables an additional \$350 LIST will apply for the special cutout required.
- > AirCharge offers a convenient way to charge any Qi compatible smartphone or device without the need to carry charging cables or find an available power outlet.
- > The Aircharge is powered by the latest Qi compliant IC offering reliable and efficient wireless charging in a convenient 3” grommet hub. Simply place your phone on the Aircharge and an LED will confirm pairing and begin wireless charging.
- > Recess: Efficient space conservation and quick access
- > Input: DC 5V (with included AC power adapter), DC 9V, 1.67A (with optional QC 2.0 power adapter)
- > Output: 5 watts Max. with DC 5V, 2A power adapter, 10 watts Max. with QC 2.0 power adapter
- > Qi V1.2 compliant IC
- > Charging distance: 6mm Max.

Available: All DARRAN collections



Cove power unit - non-linking

Style Number	List Price
 PD-COVE PLUG	\$600
Non-linking version	

Specifications

- › Size 5.75”L x 2.5”W
- › (2) 15 Amp Receptacles and (2) USB charging ports
- › Surface Mount
- › 108” Cord
- › Standard Silver Finish, Available in White or Black Finish upon request
- › ETL Listed

Available: All DARRAN collections



Cove corded series

Style Number	List Price
 PD-COVE-PKO	\$800

Specifications

- › Size 9.5”L x 2.5”W x 3.18”D
- › When used with GROVE Tables an additional \$350 LIST will apply for the special cutout required.
- › (2) Power Receptacles, (2) 2.1 Amp USB charging ports and (1) Telecom Plate Knockout
- › Surface Mount
- › 108” Cord
- › Standard Silver Finish, Available in White or Black Finish upon request
- › ETL Listed

Available: All DARRAN collections

Telecom Plates	
RJ45 (1)	\$55
RJ45 (2)	\$110
RJ45 (3)	\$165
USB (1)	\$70
USB (2)	\$140
RJ11/RJ45	\$110
RJ45/USB	\$125
RJ45/HDMI	\$210
HDMI/DVI	\$325
HDMI/USB	\$205
HDMI/VGA	\$240
VGA/MINI-STEREO	\$155
VGA/USB	\$175

This pod can have up to 1 total plates.
 *All telecom connectors sold separately.



Soba wire manager

Style Number	List Price
STARTER UNITS	
SCDW	\$200
White wire manager	
SCDB	\$200
Black wire manager	

Specifications

- › Dimensions: 9ft x 9in x 3.15in
- › Zips up, bundles and routes loose, messy cables into a single tube
- › Routes and guides cables behind desks, TVs, and anywhere cables tend to get messy
- › Accommodates large or small cables, up to three cables at once
- › Support channels, used to route cables, include powerful adhesive backing which allows easy attachment to surfaces.

Available: All DARRAN collections



VILLA Power unit - non-linking

Style Number		List Price
VIL-C PLUG		\$515
Non-Linking		

Specifications

- > Size: Top Grommet 5.68"L X 3.39"W; Under Top 12"L x 3.13"W x 3.08"D
- > (2) Power receptacles; (2) USB charging ports and (1) Knockouts for RJ45 Data Ports
- > Surface Mount
- > 72" Cord (Longer cord available, contact Customer Service)
- > Standard Silver Finish, Black Finish available upon request
- > UL or ETL Certified

Available: All DARRAN collections, excludes Grove

RJ45 Knockout	
RJ45 (1)	\$55

