



## Not So Square Office Price List

Effective April 1, 2024

Date Page  
04.12.24

Modification  
Updated Pricing

Description

Statement of Line  
Features & Advantages .....1  
Finishes | Specifications .....3  
Edges | Pulls .....4  
Grommets | Grommet Reference.....5  
Ganging | Height Reference .....6  
Metal Legs .....8  
Modesty Reference | Grain Direction.....9  
Drawer Dimensions | FILING Reference.....10  
Double Pedestal Desk.....11  
Table Desk.....12  
Freestanding Desks .....13  
Single Pedestal Desk.....14  
Conference Desk.....15  
Runoff Desk.....17  
Returns.....18  
Bridges .....21  
Freestanding Credenzas.....22  
Workstation Credenzas .....23  
Bench Cabinets .....30  
Pedestals .....31  
Single Height Freestanding Overheads.....32  
Double Height Freestanding Overheads.....35  
Overhead Accessories.....37  
Single Height Wall Hung Overheads.....41  
Double Height Wall Hung Overheads.....44  
Wall Hung Accessories .....47  
Wall Hung Overheads .....52  
Overhead Bookcases.....54  
Vertical Half Towers.....55  
Vertical Full Towers.....58  
Bookcases.....60  
Options .....61  
Power & Data.....74

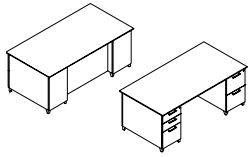

Page 12  
Freestanding Desks  
Breakfront - Full Pedestal With  
Modesty Panel

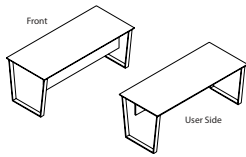

Page 13  
Freestanding Desks  
Table Desk With Sleigh Base

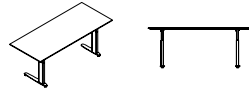

Page 14  
Freestanding Desks  
Adjustable Desk / Motorized

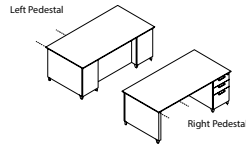

Page 15  
Freestanding Workstation Desks  
Breakfront Single Pedestal

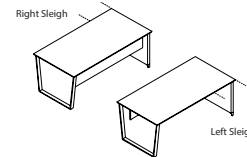

Page 16  
Conference Workstation Desks  
Rectangle Top With Sleigh Base

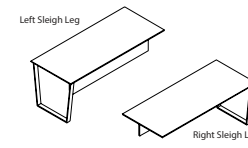

Page 17  
Runoff Conference Workstation  
Desks  
Rectangle Runoff Desk With  
Sleigh Base

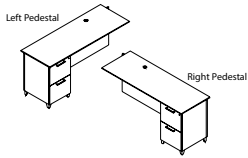

Page 18  
"L" Workstation Returns  
File/File

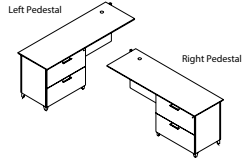

Page 19  
"L" Workstation Returns  
Lateral File

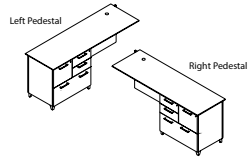

Page 20  
"L" Workstation Returns  
Multi-File

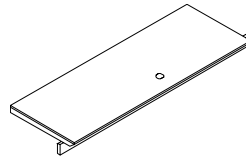

Page 21  
Workstation Bridges  
Open Back Bridge

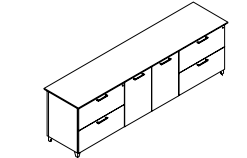

Page 22  
Freestanding Lateral File Credenzas  
Lateral File/Storage

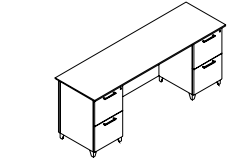

Page 23  
File Credenzas  
File/File/Kneespace

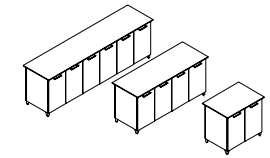

Page 24  
Freestanding Storage Credenzas  
Storage

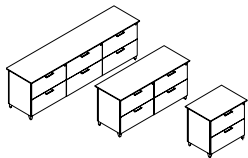

Page 25  
Freestanding Lateral File Credenzas  
Horizontal Lateral File

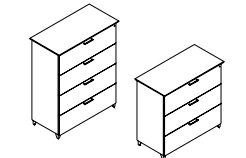

Page 26  
Freestanding Lateral File Credenzas  
Vertical Lateral File

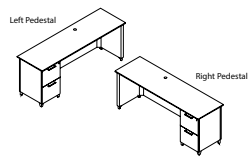

Page 27  
Workstation Credenzas  
File/File

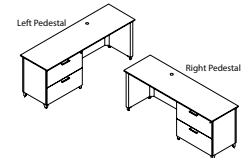

Page 28  
Workstation Credenzas  
Lateral File

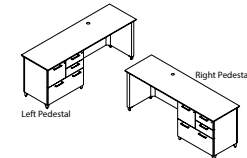

Page 29  
Workstation Credenzas  
Multi-File

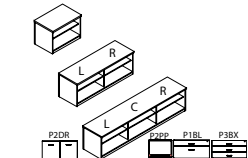

Page 30  
Bench Cabinets  
One / Two / Three Section  
Storage

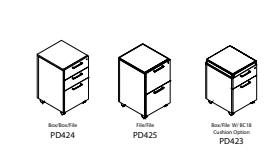

Page 31  
Freestanding Mobile Pedestal  
Mobile Pedestal - Under Surface  
Storage

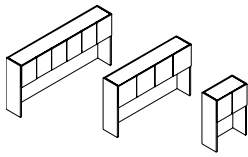

Page 32  
Single Storage Overhead  
Consoles  
Panel Door - 6/4/2 Door

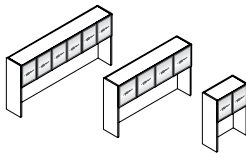

Page 33  
Single Storage Overhead  
Consoles  
Silverluma Frame Doors / 6/4/2  
Door

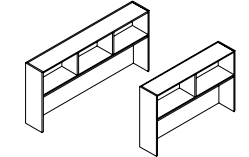

Page 34  
Single Storage Overhead  
Consoles  
Open Storage Console

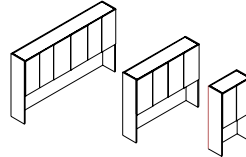

Page 35  
Double Height Overhead  
Consoles  
Panel Door

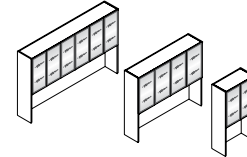

Page 36  
Double Height Overhead  
Consoles  
Silverluma Frame 6/4/2 Doors

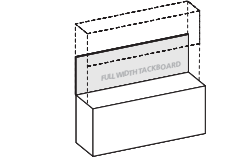

Page 37  
Overhead Tackboards

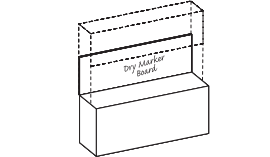

Page 38  
Overhead Dry Marker Boards

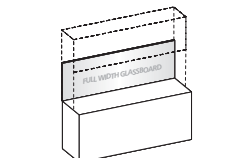

Page 39  
Overhead Glassboards

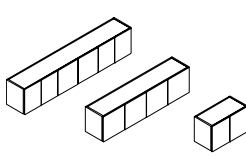

Page 40  
Single Height Wall Hung Over-  
heads  
Panel Doors

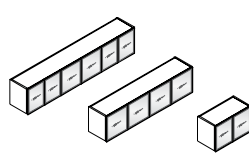

Page 41  
Single Height Wall Hung Over-  
heads  
Silverluma Frame / Doors

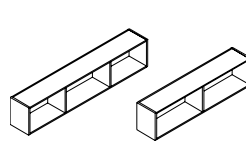

Page 42  
Single Height Wall Hung Over-  
heads  
Open Storage Cabinet

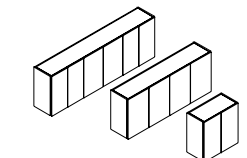

Page 43  
Double Height Wall Hung  
Overheads  
Panel Doors

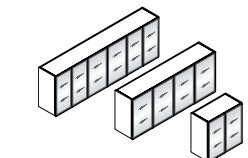

Page 44  
Double Height Wall Hung  
Overheads  
Silverluma Frame / Doors

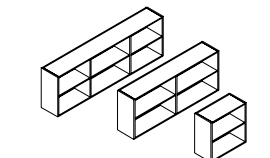

Page 45  
Double Height Wall Hung  
Overheads  
Open Storage Cabinet



Statement of Line

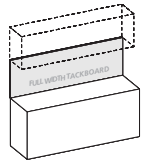

Page 46  
Wall Hung Tackboards

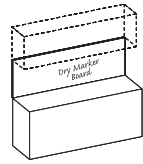

Page 47  
Wall Hung Dry Marker Boards

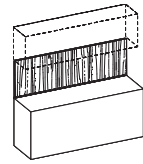

Page 48  
Wall Hung Veneer Panels

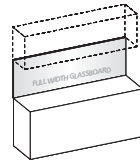

Page 49  
Wall Hung Glassboards

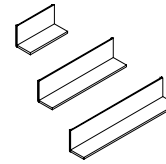

Page 50  
Single Height Wall Hung Overheads  
Open Endless Shelf Single Height

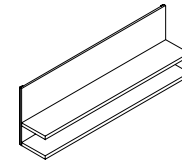

Page 51  
Double Height Wall Hung Overheads  
Open Endless Shelf Double Height

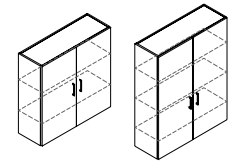

Page 52  
Overhead Bookcases  
Panel Doors / Storage

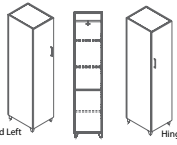

Page 53  
Freestanding Half Towers  
Wardrobe / Storage

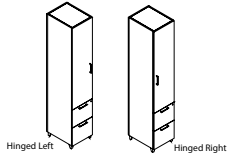

Page 54  
Freestanding Half Towers  
Storage / File

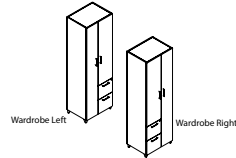

Page 55  
Freestanding Towers  
Storage / File- Mini-Wardrobe

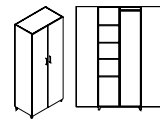

Page 56  
Freestanding Towers  
Wardrobe / Storage Full Tower

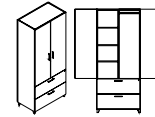

Page 57  
Freestanding Towers  
Storage / File Full Tower

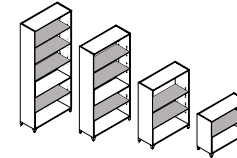

Page 58  
Open Bookcases  
Freestanding

## Veneer

DARRAN only uses HPVA AA Grade Flat Cut Cherry, Maple, and Walnut Veneers and AA Grade Quartered Oak Veneers. Not SO square is also available in double cut reconstituted walnut and oak patterns made from rapidly renewable wood veneer providing a repeatable consistent straight grain pattern. All veneers are selected and matched for balance and consistency.

## Veneer Tops

Not SO square veneer tops feature a 45-pound density substrate with balanced 3-ply construction. Tops are 1-1/8" thick on MDF core comprised of 100% recycled and recovered wood fibers. All veneer tops are slipmatched and feature a 3mm external solid hardwood band or profile edge.

## Laminate Tops

Not SO square high-pressure laminate tops feature a 45-pound density substrate with balanced 3-ply construction. Tops are 1-1/8" thick on MDF core comprised of 100% recycled and recovered wood fibers. All high pressure laminate tops are available with a profile edge, laminate self-edge or 2mm PVC edge band. Laminates in wood grain patterns feature a fine grain texture that features the polish and luxe of a real wood veneer with a subtle narrow grain structure.

## TFL tops

Thermally Fused Laminate tops feature a 45-pound density substrate with balanced 3-ply construction. Tops are 1-1/8" thick on MDF core that is comprised of 100% recycled and recovered wood fibers. All Thermally Fused Laminate tops are available with a 2mm flat PVC band. Laminates in wood grain patterns feature Timberline Texture providing the grain pattern of wood.

## Cleaning wood & laminate

In addition to regular dusting, give your furniture an occasional cleaning in accordance with our cleaning instructions. DARRAN wood and laminate products can be cleaned with a soft cloth and a mild soap and water mixture. Use approximately 32 oz of water mixed with one tablespoon of dish soap, always wiping with the grain. Dry with a soft cloth, going with the grain, to avoid spotting or streaking.

Wood products should be waxed periodically using a non-wax liquid; please do not use any waxy polish or cleaner. Interior of drawers may also be cleaned with mild soap and water mixture, or any household cleaner that is not petroleum or thinner-based.

## Chassis & pedestal

Chassis components are 3/4" thick core of particle board or MDF rated EPP/SCS/CARB-II material with 3-ply balanced construction. Pedestal and Cabinets feature dowel construction reinforced with steel bracket plates, wood cleats, screws and glue. All units are standard with 1" adjustable glides that allow for leveling of units that are secured in

solid wood glide blocks to prevent tearout.

## Overhead cabinet construction Freestanding & wall mount

Freestanding Overhead storage cabinets are constructed of 1" and 3/4" thick core of particle board or MDF rated EPP/SCS/CARB-II material with 3-ply balanced construction. Panels are attached with cam fasteners in conjunction with dowels securely adhered with PVAc glue. All surface mount cabinets connect to work surface with anti-slip tape. Wall mount cabinets are mounted to the wall with steel "z" bracket attachment method using 5mm euro screws to attach to the back of the cabinet. All units ship with a steel "z" bracket. This bracket is mounted to the wall by field installers. Installers are responsible for selecting and supplying appropriate fasteners for wall conditions.

## Bookcase Construction

All chassis (sides, back, top and bottom panels) are constructed with 3/4" thick core of particle board or MDF rated EPP/SCS/CARB-II material with 3-ply balanced construction. Panels are attached with cam-lock fasteners in conjunction with dowels securely adhered with glue. Shelves on all units are 3/4" thick balance 3 ply panels. Optional heavy duty shelves are 1" thick lumber core balanced 5 ply construction.

## Tackboards

Wall mount tackboards are constructed of .75" thick fiberboard. The fabric is precisely aligned and fitted to the tackboard with a sock on cover. Overhead storage tackboards are constructed of .75" thick fiberboard. The fabric is precisely aligned and fitted to the tackboard and adhered to the rigid hardboard with staples. Wall mount cabinets are mounted to the wall with steel "z" bracket attachment method using 5mm euro screws to attach to the back of the cabinet. All units ship with a steel "z" bracket. This bracket is mounted to the wall by field installers. Installers are responsible for selecting and supplying appropriate fasteners for wall conditions.

## Adjustable glides

Glides provide 1" of vertical leveling adjustment. Glide bottom is durable metal. Glides are secured in solid wood blocks that are screwed and glued for durability.

## Drawers

All drawers are constructed with mitre joint/dowel construction in a natural maple finish with four sides and a bottom, which are attached to a drawer front with screws for easy removal. Drawer fronts are vertically matched in balanced sets. Pencil trays are standard in all box drawers. Drawers are constructed of 1/2" thick wood grained wrapped 5 sided miter-folded construction with 1/4" thick hardboard bottoms reinforced for heavy weight capacity. Drawers have been tested and pass BIFMA 50,000 cycle test. All drawers are guaranteed lifetime with free replacement warranty.

## Optional wood drawers

Optional hardwood veneer plywood drawers feature banded top and bottom edges for smoothness. Drawers are dowel joint construction with a UV cured finish over maple veneers, plus a lifetime free replacement guarantee.

Optional Wood Drawer (Any Size) – Option Code P33...\$45 List Price Per Drawer

## Drawer fronts

Drawer fronts are vertically matched in balanced sets. Doors feature vertical veneer bookmatched horizontally in sets of 2 / 4 and 6 doors. All drawers and doors have traditional scallop profile edge shape. All tower fronts matched in vertical sets.

## Suspensions

All casegoods utilize cold rolled steel zinc plated high-grade drawer suspensions. All suspensions are warranted for the lifetime of the product. Box and File drawers are full extension, featuring steel ball bearings for a smoother quieter range of motion and are rated 100lbs. Lateral file drawers are a progressive action full extension suspension and is rated at 150lbs. Veneer and High Pressure laminate casegoods feature soft close suspension. Thermally Fused Laminate casegoods feature standard suspensions. Lateral files include anti tip mechanism that allow only one drawer to be opened at a time.

## Hinges

Units with doors include 95 degree swing hinges.

## Filing

Not SO square features a highly durable black plastic extrusion that is securely fastened into a route on top of the drawer to support hanging files. An adjustable crossbar is provided for all file drawers that enables legal/letter filing front to back or side-to-side based on the drawer size..

## Locks

Locks are Standard on all drawers below the worksurface. Random lock cores are installed at the factory. Some units may be shipped with the same key number. Locks are Silver, Black or Bronze and match pull finish unless otherwise specified.

DARRAN will also send lock cores separately to the dealer at your request. These units will be send with an empty lock core and the Dealer will receive a shipment of the requested lock core/keys.

## Keying

Keying is available either factory or field installed. Factory installed keying is random.

## Wire management

Wire management capabilities include standard and optional worksurface grommets. Specify W-1 under surface wire channels for organization and management of all communication wires and cords. Horizontal J-Channel wire management (Sku: W-1) is sold separately to conceal wire under worksurfaces.

## Grommets

Metal grommets are provided to match the drawer pull selection. Grommet is available in black, silver or white. Must specify standard or non-standard location. Black plastic grommets are available as an option for vertical applications.

## Powerports

A large selection of power pods are available and handle power, data, docking stations and communication. See options section for selection.

## LED tasklights

LED task lighting provides high efficiency, low energy lighting with a long life. Surface mounted light is encased in silver aluminum channel with milk lense and rounded end caps. Lights are field installed. Product specifications listed below:

- Diffuser creates a softer light and eliminates hot spots
- Touch dimmer switch
- Can be “daisy chained” up to 90W
- 4.6 watts per foot
- 120 LEDs per meter
- Certification: UL Listed
- 50,000 hour life span.

Color Temp is 4000K

VENEER FINISHES

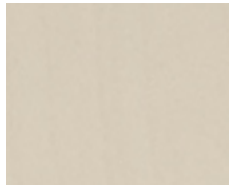

WAM Alabaster Maple



WAF Narvik Ash



WCM Clear Maple



WLF Lofty Oak



WWW Weathered Walnut



WFF Fawn Cypress



WNF Natural Oak



WEF Neo Walnut



WGW Gunstock Walnut



WHC Honey Cherry



WAC Amber Cherry



WSW Smokey Walnut



WMF Mocha Oak



WNW Natural Walnut



WIC Crimson Cherry

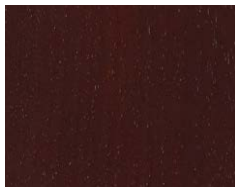

WEW Executive Walnut



WBW Henna Walnut



WOC KoKo Cherry



WEC Ebony Cherry

PREMIUM VENEER



WLO Lofty Oak



TBCO Baby's Cheek

PREMIUM VENEER



WFO Fawn Cypress



WNO Natural Oak



TOBW Organic Brown



TSTV Studio Teak

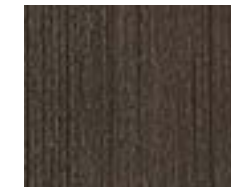

TSLV Skyline Walnut



TBSW Brown Sugar



WMO Mocha Oak

Finish

Welltech Finish delivers a superior furniture coating with exceptional performance that can withstand stringent cleaning agents and possesses unparalleled durability, allowing DARRAN to provide lasting, sustainable products to our customers.



HIGH PRESSURE LAMINATES



GWL Designer White

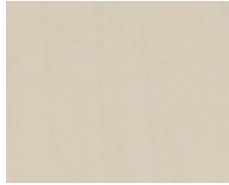

GAM Alabaster Maple



GNA Narvik Ash



GCM Clear Maple



GSTV Studio Teak



GSLV Skyline Walnut



GAC Amber Cherry



GIC Crimson Cherry



GEW Executive Walnut



GHC Honey Cherry



GNW Natural Walnut



LW01 Neo Walnut



LW02 Fawn Cypress



GOC KoKo Cherry

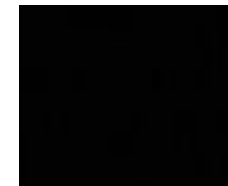

GEC Ebony

TFL LAMINATES

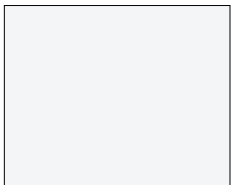

MWL Designer White



MNA Narvik Ash



MWW Weathered Walnut



MTW Studio Teak



MGW Gunstock Walnut



MAC Amber Cherry

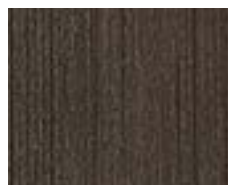

MSW Skyline Walnut



MOC KoKo Cherry



MEC Ebony

PAINTS (On Maple Veneer)



\* Pure White (PM21)



\* Boucle White (PM13)



Designer White (WWP)



Skyline Steel (PSS-SW 1015)



\* Warm Gray (PM14)



\* Golden Sand (PM17)



Evergreen Fog (PEF-SW 9130)



\* Artifact Gray (PM12)



Designer White (WWP)



\* Flagstone (PM11)



\* Gold Umber (PM15)



\* Redwood (PM19)



\* London Gray (PM16)



Cyberspace (PCS-SW 7076)



\* Nutmeg (PM18)



\* Cloudburst (PM22)



\* Maritime (PM23)



\* Moonless Night (PM20)

\* Contrasting Tops and Chassis are available for additional charge.  
Contact Customer Service for Quote

POWDERCOATS

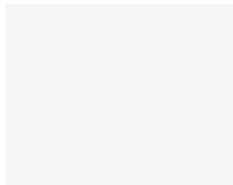

MFW White



MFCH Chrome

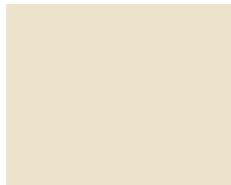

MFOS Oyster

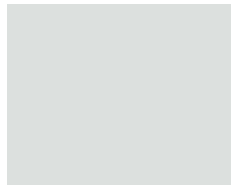

MFG Grey



MFGW Gray White



MFS Silver



MFGB Grey Beige



MFGM Gold



MFSB Satin Bronze



MFGG Graphite Gray



MFNA Navy



MFMB Matte Black

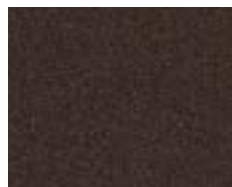

MFDB Dark Bronze

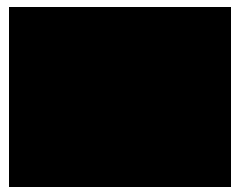

MFB Black

# DARRAN

## Not So Square Edges & Pulls

### Standard profile

NSS Edge

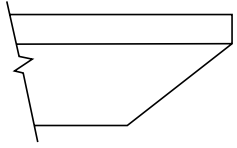

### NSS Bevel

"W" 3mm Solid Hardwood Band  
"G" PVC Edge on Wood Chassis

### NSS Bevel

"G" 2mm PVC Edge with Black Foil  
on Melamine Chassis

### Pulls/knobs

Factory Installed

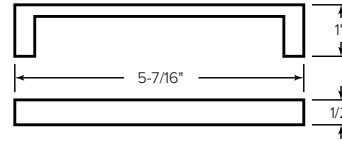

PL-115 Matte Black  
PL-116 Matte Nickel

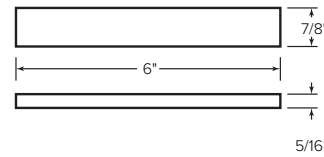

PL-210 Anodized Aluminum

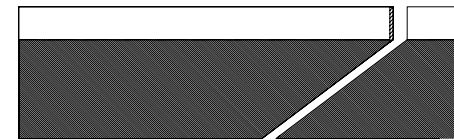

### Bridge/return hookup edge

Hookup tops feature reverse cope shaping for custom flush surface appearance and improved use.



# DARRAN®



TM30  
Black  
1-5/8" Dia.



TM31  
Silver  
1-5/8" Dia.



TM34  
White  
1-5/8" Dia.

## Optional grommets

Factory Installed

Grommets (Standard Location)

Specify Color and Left/Right/Center - \$50 ea.

- Black: TM30-R (Right), TM30-L (Left), TM30-C (Center)
- Silver: TM31-R (Right), TM31-L (Left), TM31-C (Center)
- White: TM34-R (Right), TM34-L (Left), TM34-C (Center)

Grommets (Non-Standard Location)

Provide drawing w/ Grommet Location and Specify Color - \$95 ea.

- Black: TM30-NS
- Silver: TM31-NS
- White: TM34-NS

## Not So Square Grommets | Grommet Reference

TM50  
Black  
1-5/8" Dia.



### Grommets (vertical surface)

Standard Location - \$50 ea.

- Black Plastic Vertical Surface: TM50-C (Bottom Center)

Non-Standard Location - \$95 ea.

- Black Plastic Vertical Surface: TM50-NS

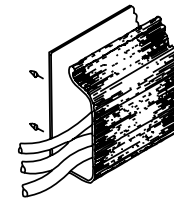

W1

### Horizontal J-channel

Horizontal J-Channel wire management (Sku: W-1) is sold separately to conceal wire under worksurfaces.

## Standard grommet location reference

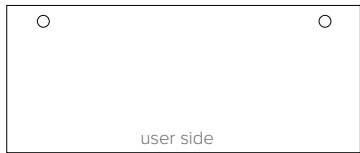

Desk  
Specify Right or Left Grommet

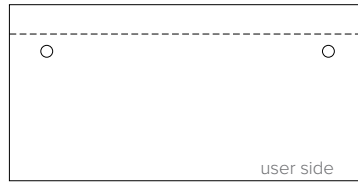

6" Overhang Desk  
Specify Right or Left Grommet

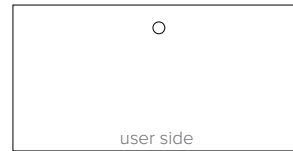

Bridge  
Center Grommet



Return (Left Pedestal Shown)  
Right Pedestal - Left Grommet  
Left Pedestal - Right Grommet

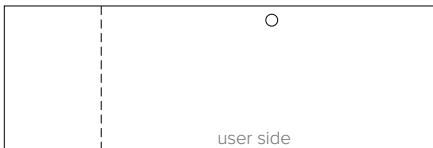

Workstation Credenza  
Center Kneespace Grommet

**Ganging – flush cut modification**

30”H Casework Worksurface & Base Ganging Modifications

To gang two casework units, each unit end to be ganged must be flush cut modified for gapless surfaces and cabinet chassis.

Order Option:

- FC-B: Flush Unit Both Sides(Facing) for Ganging - \$100
- FC-L: Flush Unit Left (Facing) for Ganging - \$100
- FC-R: Flush Unit Right (Facing) for Ganging - \$100

Flush cut modification per unit includes all modifications to gang to one end or both ends when units are ganged. Modification includes tops, base and molding. Modification reduces width size approximately 1” per end.

Example:  
 NSS3121100W Two Drawer Lateral File (Left) Flush Cut Right – FC-R...\$100  
 NSS7221054 Kneespace Credenza (Right) Flush Cut Left – FC-L...\$100

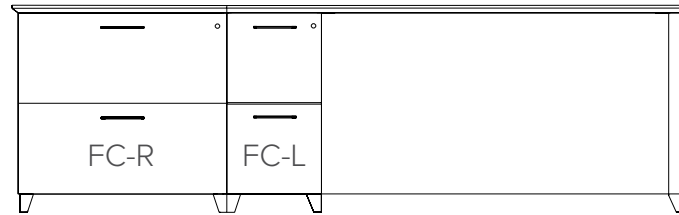

**Height reference**

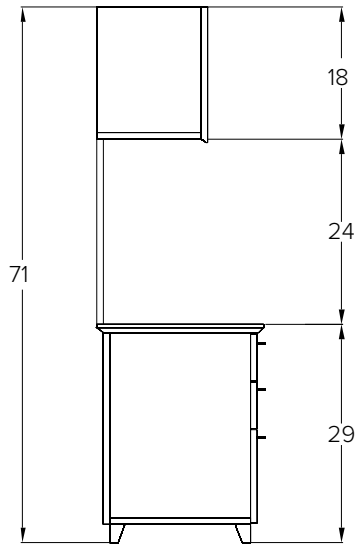

Typical Single Height Side Profile Wall Hung Overhead

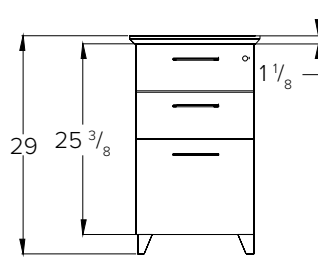

Pedestal Front Profile Box/Box/File

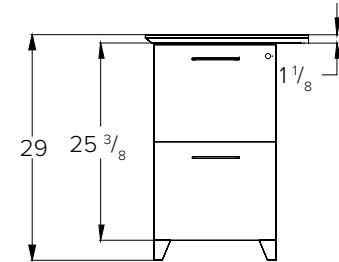

Pedestal Front Profile File/File

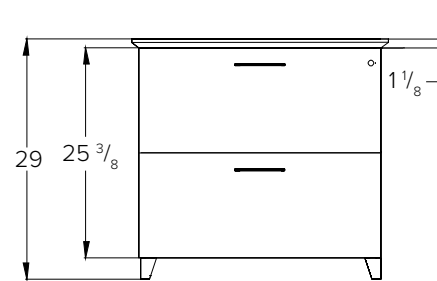

Pedestal Front Profile Lateral File

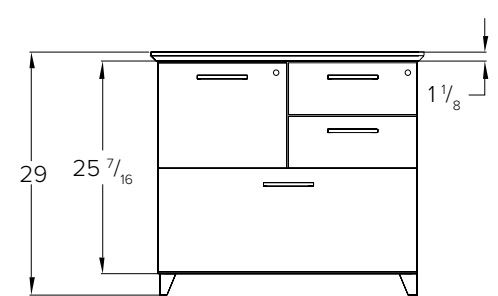

Pedestal Front Profile Multi-File

## Credenzas, overheads and towers

Towers and overheads are standard flat top for easy ganging. No modification needed.

Credenza must be specified for flush cut ends when ganging to towers.

Credenza width matches overhead width when both credenza ends are flush cut.

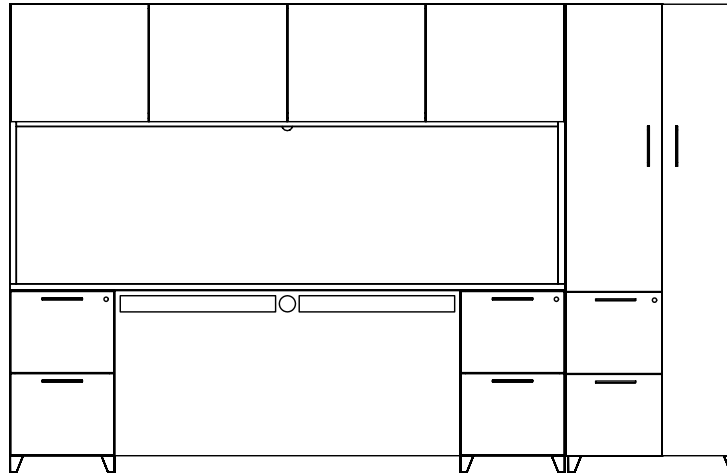

CABINET ANGULAR FOOT  
Cast Angular Foot

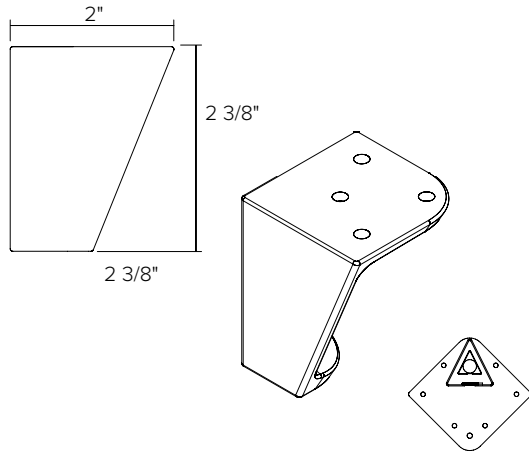

DESK ANGULAR POST

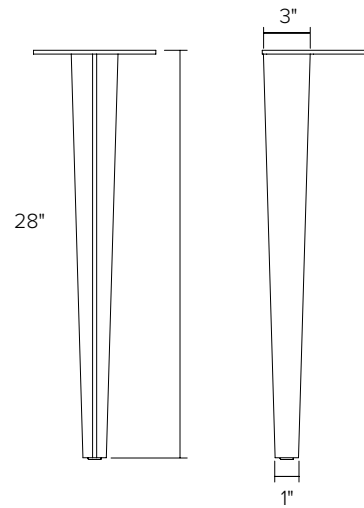

DESK ANGULAR SLEIGH BASE

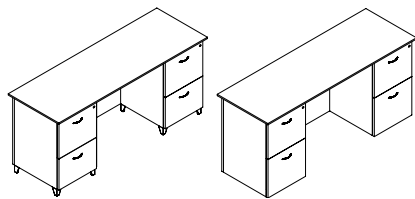
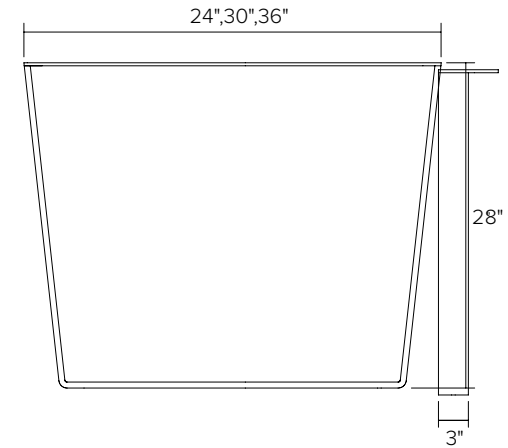

Option: Delete Feet/Extended Fronts

Standard metal feet can be deleted on any unit. Delete foot option extends chassis cabinets to floor. Drawer/Door fronts are extended to within 3/8" of full cabinet height when delete foot option is specified.

Delete Foot Chassis Modification Option:  
D8. . .No Charge

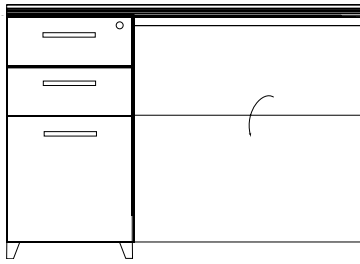

**M34**  
Drop Door Tech Modesty

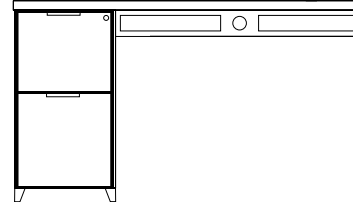

**M51**  
Open Back Modesty with 4"  
Wire Management Rail

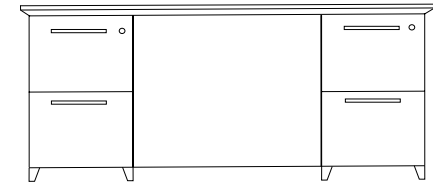

**M37**  
Fixed Full Modesty

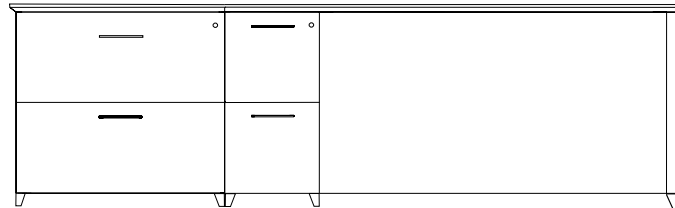

### Grain direction

Veneer chassis parts are vertical grain. The backs of Thermally Fused Laminate overheads, wall hungs, wall hung shelves and flush chassis desks are horizontal grain. Bridges, returns, and credenza kneespace Thermally Fused Laminate backs over 60" are horizontal grain. Doors feature vertical veneer bookmatched horizontally in sets of 2,4, and 6 doors. Tower fronts are matched in vertical sets.

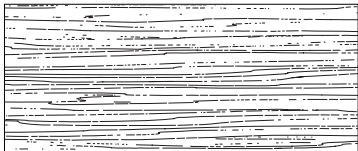

Desk

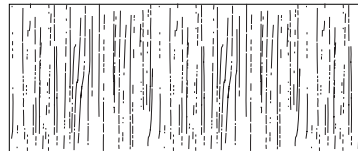

Runoff Desk  
Grain Direction on TFL Units  
Above 60" runs end to end

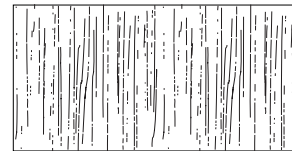

Bridge  
Grain Direction on TFL Units  
Above 60" runs end to end

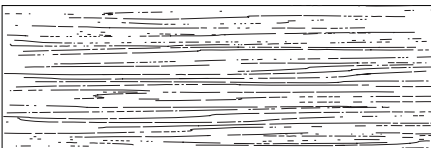

Credenza

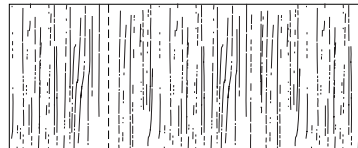

Return  
Grain Direction on TFL Units  
Above 60" runs end to end

# NOT SO square office

Freestanding Desks  
Breakfront - Full Pedestal With Modesty Panel

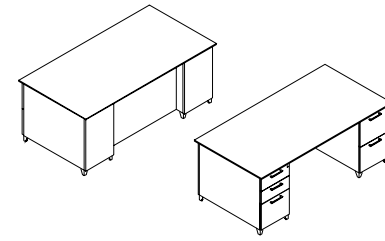

[Click here to view statement of line](#)

## 1 Select Model

w" x d" x h"	Weight
84 x 36 x 29	350
72 x 36 x 29	315
72 x 30 x 29	295
66 x 30 x 29	270

Standard Veneer Top Standard Veneer Chassis		Premium Veneer Top Premium Veneer Chassis		High Pressure Laminate Top Veneer Chassis		High Pressure Laminate Top Thermally Fused Laminate Chassis	
--	--	--	--	--	--	--	--

NSS8436DD000W	5214	NSS8436DD000P	5736	NSS8436DD000G	5214	NSS8436DD000M	3529
NSS7236DD000W	4846	NSS7236DD000P	5332	NSS7236DD000G	4846	NSS7236DD000M	3403
NSS7230DD000W	4625	NSS7230DD000P	5087	NSS7230DD000G	4625	NSS7230DD000M	3357
NSS6630DD000W	4581	NSS6630DD000P	5041	NSS6630DD000G	4581	NSS6630DD000M	3283

## Product Features

- 6" recessed modesty
- Breakfront modesty
- Locking drawers
- Soft close suspension drawer(s)
- Standard Silver Feet (optional White, Black)

## Options

### Accessories

- K28: Articulating Keyboard w/ Mouse - \$390
- K31: Center Drawer w/out Pull - \$205

### Chassis

- MODCX: Modify breakfront chassis to flush front chassis - n/c

### Drawer

- P6: Modify File/File to Box/Box/File - \$55 per pedestal
- P33: Wood Drawer Upgrade - \$45 per drawer
- WPD3061: Designer White - \$80 per pedestal

### Feet

- D8: Delete feet (extend fronts to floor) - n/c

### Grommets (Standard Location)

Specify Color and Location Right/Left - \$50 ea.

- Black: TM30-R (Right), TM30-L (Left)
- Silver: TM31-R (Right), TM31-L (Left)
- White: TM34-R (Right), TM34-L (Left)

### Grommets (Non-Standard Location)

Provide drawing w/ Grommet Location and Specify Color - \$95 ea.

- Black: TM30-NS
- Silver: TM31-NS
- White: TM34-NS

### Modesty

- HM51: Half Modesty - \$205
- HM39: SilverLuma frame/frost (Half Modesty) - \$340

### Premium Finish Option

- Specify foot Metal Finish color - \$30/Foot (8 feet total)
- MFB: Black, MFW: White, MFDB: Dark Bronze, MFGM: Matte Gold

## 2 Select Finish

[Click to view finishes](#)

[Click to view finishes](#)

[Click to view finishes](#)

[Click to view finishes](#)

## 3 Select Edge



## 4 Select Hardware



# NOT SO square office

Freestanding Desks  
Table Desk With Sleigh Base

[Click here to view statement of line](#)

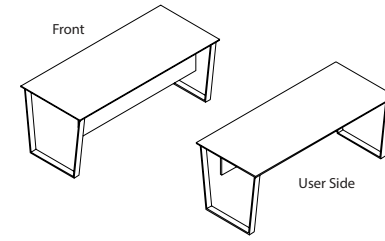

## 1 Select Model

w" x d" x h"	Weight
72 x 36 x 29	150
72 x 30 x 29	135
66 x 30 x 29	125

Standard Veneer Top Standard Veneer Chassis		Premium Veneer Top Premium Veneer Chassis		High Pressure Laminate Top Veneer Chassis		High Pressure Laminate Top Thermally Fused Laminate Chassis	
NSS7236DT107W	4512	NSS7236DT107P	4962	NSS7236DT107G	4512	NSS7236DT107M	2697
NSS7230DT107W	4317	NSS7230DT107P	4750	NSS7230DT107G	4317	NSS7230DT107M	2605
NSS6630DT107W	4262	NSS6630DT107P	4688	NSS6630DT107G	4262	NSS6630DT107M	2511

## Product Features

- Half modesty panel standard
- Freestanding use
- Standard table desk sleigh base is silver Metal Finish (optional white or black)

## Options

### Accessories

- K28: Articulating Keyboard w/ Mouse - \$390
- K31: Center Drawer w/out Pull - \$205
- W17: Wire Mgmt. Cover matches leg finish - \$80

### Grommets (Standard Location)

Specify Color and Location Right/Left - \$50 ea.

- Black: TM30-R (Right), TM30-L (Left)
- Silver: TM31-R (Right), TM31-L (Left)
- White: TM34-R (Right), TM34-L (Left)

### Grommets (Non-Standard Location)

Provide drawing w/ Grommet Location and Specify Color - \$95 ea.

- Black: TM30-NS
- Silver: TM31-NS
- White: TM34-NS

### Premium Finish Option

- Specify Metal Base Finish color - \$320 (\$160/base)
- MFB: Black, MFW: White

## 2 Select Finish

[Click to view finishes](#)

[Click to view finishes](#)

[Click to view finishes](#)

[Click to view finishes](#)

## 3 Select Edge



## 4 Select Hardware

Hardware  
N/A

Hardware  
N/A

Hardware  
N/A

Hardware  
N/A



# NOT SO square office

Freestanding Desks  
Adjustable Desk / Motorized

[Click here to view statement of line](#)

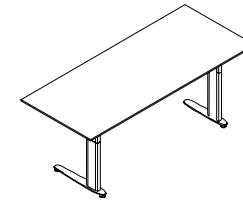

## 1 Select Model

w" x d" x h"	Weight
72 x 30 x 29-48	230
66 x 30 x 29-48	215
60 x 30 x 29-48	200

Standard Veneer Top Standard Veneer Chassis		Premium Veneer Top Premium Veneer Chassis		High Pressure Laminate Top Veneer Chassis		High Pressure Laminate Top Thermally Fused Laminate Chassis	
NSS7230DT090W	4709	NSS7230DT090P	5181	NSS7230DT090G	4709	NSS7230DT090M	3151
NSS6630DT090W	4683	NSS6630DT090P	5153	NSS6630DT090G	4683	NSS6630DT090M	3080
NSS6030DT090W	4654	NSS6030DT090P	5120	NSS6030DT090G	4654	NSS6030DT090M	3001

## Product Features

- Adjustable height base - silver, white or black
- Electronic mechanism with programmable lift
- Unit includes 72" power cord

## Notes

- Shipped KD

## Options

### Accessories

- K28: Articulating Keyboard w/ Mouse - \$390
- K31: Center Drawer w/out Pull - \$205
- W18: Coil Cable Manager - \$160

### Grommets (Standard Location)

Specify Color and Location Right/Left - \$50 ea.

- Black: TM30-R (Right), TM30-L (Left)
- Silver: TM31-R (Right), TM31-L (Left)
- White: TM34-R (Right), TM34-L (Left)

### Grommets (Non-Standard Location)

Provide drawing w/ Grommet Location and Specify Color - \$95 ea.

- Black: TM30-NS
- Silver: TM31-NS
- White: TM34-NS

### Modesty

- HM3: Veneer Half Modesty - \$260 (For "W" and "G")
- HM3M: Melamine Half Modesty - \$205 (For "M")

## 2 Select Finish

[Click to view finishes](#)

[Click to view finishes](#)

[Click to view finishes](#)

[Click to view finishes](#)

## 3 Select Edge



## 4 Select Hardware

Hardware  
N/A

Hardware  
N/A

Hardware  
N/A

Hardware  
N/A

# NOT SO square office

Freestanding Workstation Desks  
Breakfront Single Pedestal

[Click here to view statement of line](#)

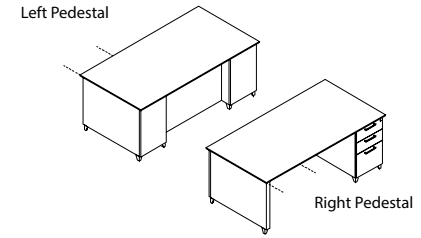

## 1 Select Model

w" x d" x h"	Weight
Left Pedestal	
72 x 36 x 29	300
72 x 30 x 29	270
66 x 30 x 29	260
Right Pedestal	
72 x 36 x 29	300
72 x 30 x 29	270
66 x 30 x 29	260

	Standard Veneer Top Standard Veneer Chassis		Premium Veneer Top Premium Veneer Chassis		High Pressure Laminate Top Veneer Chassis		High Pressure Laminate Top Thermally Fused Laminate Chassis	
	NSS7236DS009W	4733	NSS7236DS009P	5207	NSS7236DS009G	4733	NSS7236DS009M	2865
	NSS7230DS009W	4520	NSS7230DS009P	4972	NSS7230DS009G	4520	NSS7230DS009M	2794
	NSS6630DS009W	4481	NSS6630DS009P	4931	NSS6630DS009G	4481	NSS6630DS009M	2741
	NSS7236DS010W	4733	NSS7236DS010P	5207	NSS7236DS010G	4733	NSS7236DS010M	2865
	NSS7230DS010W	4520	NSS7230DS010P	4972	NSS7230DS010G	4520	NSS7230DS010M	2794
	NSS6630DS010W	4481	NSS6630DS010P	4931	NSS6630DS010G	4481	NSS6630DS010M	2741

## Product Features

- 6" recessed modesty
- Full extension drawers - locking
- Soft close suspension drawer(s)
- Standard Silver Feet (optional White, Black)

## Options

### Accessories

- K28: Articulating Keyboard w/ Mouse - \$390
- K31: Center Drawer - \$205

### Chassis

- MODCX-1: Modify breakfront chassis to flush front chassis w/ 6" overhang top - n/c

### Drawer

- P33: Wood Drawer Upgrade - \$45 per drawer
- WPD3061: Designer White - \$80 per pedestal

### Feet

- D8: Delete feet (extend fronts to floor) - n/c

### Grommets (Standard Location)

- Specify Color and Location Right/Left - \$50 ea.
- Black: TM30-R (Right), TM30-L (Left)
  - Silver: TM31-R (Right), TM31-L (Left)
  - White: TM34-R (Right), TM34-L (Left)

### Grommets (Non-Standard Location)

Provide drawing w/ Grommet Location and Specify Color - \$95 ea.

- Black: TM30-NS
- Silver: TM31-NS
- White: TM34-NS

### Modesty

- HM39: SilverLuma frame/frost (Half Modesty) - \$340
- HM51: Half Modesty - \$205

### Premium Finish Option

- Specify foot Metal Finish color - \$30/foot (7 feet Total)
- MFB: Black, MFW: White, MFDB: Dark Bronze, MFGM: Matte Gold

## 2 Select Finish

Click to view finishes

## 3 Select Edge

NSS Bevel

## 4 Select Hardware

PL-115 Matte Black  
PL-116 Matte Nickel

PL-210 Anodized Aluminum

PL-260 Anodized Aluminum  
PL-261 White

Finger Pull "W"/"G"

# NOT SO square office

Conference Workstation Desks  
Rectangle Top With Sleigh Base

[Click here to view statement of line](#)

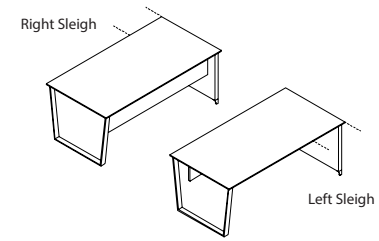

## 1 Select Model

Weight	Standard Veneer Top Standard Veneer Chassis	Premium Veneer Top Premium Veneer Chassis	High Pressure Laminate Top Veneer Chassis	High Pressure Laminate Top Thermally Fused Laminate Chassis
w" x d" x h"				
Right Sleigh Leg				
72 x 36 x 29	165	NSS7236DC766W 4311	NSS7236DC766P 4742	NSS7236DC766G 4311
72 x 30 x 29	145	NSS7230DC766W 4117	NSS7230DC766P 4530	NSS7230DC766G 4117
66 x 30 x 29	125	NSS6630DC766W 4076	NSS6630DC766P 4483	NSS6630DC766G 4076
60 x 24 x 29	115	NSS6024DC766W 2650	NSS6024DC766P 2916	NSS6024DC766G 2650
54 x 24 x 29	105	NSS5424DC766W 2620	NSS5424DC766P 2883	NSS5424DC766G 2620
Left Sleigh Leg				
72 x 36 x 29	165	NSS7236DC767W 4311	NSS7236DC767P 4742	NSS7236DC767G 4311
72 x 30 x 29	145	NSS7230DC767W 4117	NSS7230DC767P 4530	NSS7230DC767G 4117
66 x 30 x 29	125	NSS6630DC767W 4076	NSS6630DC767P 4483	NSS6630DC767G 4076
60 x 24 x 29	115	NSS6024DC767W 2650	NSS6024DC767P 2916	NSS6024DC767G 2650
54 x 24 x 29	105	NSS5424DC767W 2620	NSS5424DC767P 2883	NSS5424DC767G 2620

## 2 Select Finish

[Click to view finishes](#)

[Click to view finishes](#)

[Click to view finishes](#)

[Click to view finishes](#)

## 3 Select Edge



## 4 Select Hardware

Hardware  
N/A

Hardware  
N/A

Hardware  
N/A

Hardware  
N/A

## Product Features

- 2" thick end panel
- Angular silver metal sleigh base
- Half modesty
- Standard Silver Feet and Base (optional White, Black)

## Notes

- K28 and K31 will not fit on 24" deep units w/ half modesty

## Options

### Accessories

- K31: Center drawer - \$205
- K28: Articulating Keyboard w/ Mouse - \$390
- W17: Wire Mgmt. Cover, matches leg finish - \$80

### Grommets (Standard Location)

- Specify Color - \$50 ea.
- Black: TM30-C (Center)
- Silver: TM31-C (Center)
- White: TM34-C (Center)

### Grommets (Non-Standard Location)

- Provide drawing w/ Grommet Location and Specify Color - \$95 ea.
- Black: TM30-NS
- Silver: TM31-NS
- White: TM34-NS

### Modesty

- DM: Delete half modesty - n/c
- HM45: SilverLuma frame/frost insert (half modesty) - \$415

### Premium Finish Option

- Premium Color for Base and Feet - \$210 per unit.
- MFB: Black, MFW: White

# NOT SO square office

Runoff Conference Workstation Desks  
 Rectangle Runoff Desk With Sleigh Base

[Click here to view statement of line](#)

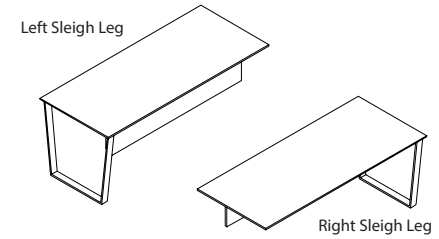

## 1 Select Model

w" x d" x h"  
 Right Sleigh Leg  
 72 x 30 x 29  
 66 x 30 x 29  
 60 x 30 x 29  
 54 x 24 x 29  
 Left Sleigh Leg  
 72 x 30 x 29  
 66 x 30 x 29  
 60 x 30 x 29  
 54 x 24 x 29

Weight

	Standard Veneer Top Standard Veneer Chassis		Premium Veneer Top Premium Veneer Chassis		High Pressure Laminate Top Veneer Chassis		High Pressure Laminate Top Thermally Fused Laminate Chassis	
	NSS7230DR770W	3697	NSS7230DR770P	4067	NSS7230DR770G	3697	NSS7230DR770M	1831
	NSS6630DR770W	3668	NSS6630DR770P	4035	NSS6630DR770G	3668	NSS6630DR770M	1708
	NSS6030DR770W	3638	NSS6030DR770P	4002	NSS6030DR770G	3638	NSS6030DR770M	1649
	NSS5424DR770W	2337	NSS5424DR770P	2572	NSS5424DR770G	2337	NSS5424DR770M	1563
	NSS7230DR771W	3697	NSS7230DR771P	4067	NSS7230DR771G	3697	NSS7230DR771M	1831
	NSS6630DR771W	3668	NSS6630DR771P	4035	NSS6630DR771G	3668	NSS6630DR771M	1708
	NSS6030DR771W	3638	NSS6030DR771P	4002	NSS6030DR771G	3638	NSS6030DR771M	1649
	NSS5424DR771W	2337	NSS5424DR771P	2572	NSS5424DR771G	2337	NSS5424DR771M	1563

## 2 Select Finish

[Click to view finishes](#)

[Click to view finishes](#)

[Click to view finishes](#)

[Click to view finishes](#)

## 3 Select Edge



NSS Bevel



NSS Bevel



NSS Bevel



NSS Bevel

## 4 Select Hardware

Hardware  
N/A

Hardware  
N/A

Hardware  
N/A

Hardware  
N/A

## Product Features

- Half modesty standard
- Standard Silver Base (optional White, Black)

## Notes

- When Specifying Runoff Desk w/ Bench Credenzas, You Must: Specify Runoff Desk Bench Support.
- K28 and K31 will not fit on 24" deep units w/ half modesty
- Hooks to freestanding unit

## Options

### Accessories

- K28: Articulating Keyboard w/ Mouse - \$390
- K31: Center Drawer - \$205
- W17: Wire Mgmt. Cover, matches leg finish - \$80

### Bench Support

- 23BRL30: 30" Bench Support - "W" and "G" \$195 - "M" \$130
- 23BRL24: 24" Bench Support - "W" and "G" \$155 - "M" \$115

### Grommets (Standard Location)

- Specify Color - \$50 ea.
- Black: TM30-C (Center)
  - Silver: TM31-C (Center)
  - White: TM34-C (Center)

### Grommets (Non-Standard Location)

- Provide drawing w/ Grommet Location and Specify Color - \$95 ea.
- Black: TM30-NS
  - Silver: TM31-NS
  - White: TM34-NS

### Modesty

- DM: Delete Half Modesty - n/c
- HM45: SilverLuma frame/frost insert (half modesty) - \$395

### Premium Finish Option

- Specify foot Metal Finish color - \$160 per unit. Contact customer service
- MFB: Black, MFW: White, MFDB: Dark Bronze, MFGM: Matte Gold

# NOT SO square office

"L" Workstation Returns  
File/File

[Click here to view statement of line](#)

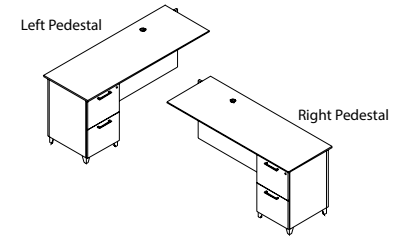

## 1 Select Model

w" x d" x h"  
Left Pedestal  
60 x 22 x 29  
54 x 22 x 29  
48 x 22 x 29  
42 x 22 x 29  
Right Pedestal  
60 x 22 x 29  
54 x 22 x 29  
48 x 22 x 29  
42 x 22 x 29

Weight	Standard Veneer Top Standard Veneer Chassis	Premium Veneer Top Premium Veneer Chassis	High Pressure Laminate Top Veneer Chassis	High Pressure Laminate Top Thermally Fused Laminate Chassis
160	NSS6022RE195W 3673	NSS6022RE195P 4040	NSS6022RE195G 3673	NSS6022RE195M 2005
145	NSS5422RE195W 3651	NSS5422RE195P 4018	NSS5422RE195G 3651	NSS5422RE195M 1908
135	NSS4822RE195W 3514	NSS4822RE195P 3866	NSS4822RE195G 3514	NSS4822RE195M 1835
125	NSS4222RE195W 3467	NSS4222RE195P 3814	NSS4222RE195G 3467	NSS4222RE195M 1788
160	NSS6022RE196W 3673	NSS6022RE196P 4040	NSS6022RE196G 3673	NSS6022RE196M 2005
145	NSS5422RE196W 3651	NSS5422RE196P 4018	NSS5422RE196G 3651	NSS5422RE196M 1908
135	NSS4822RE196W 3514	NSS4822RE196P 3866	NSS4822RE196G 3514	NSS4822RE196M 1835
125	NSS4222RE196W 3467	NSS4222RE196P 3814	NSS4222RE196G 3467	NSS4222RE196M 1788

## Product Features

- All drawers lock
- Standard full fixed modesty panel
- Standard metal grommet matches pull finish
- Standard silver feet (optional White, Black)
- Soft close suspension drawer(s)

## Notes

- Laminate version "M" standard w/ open plan back
- Returns with Grommets in top will automatically have wire channel and outfeed holes in back.
- Unit not designed for open plan use. Select OPB for Open Plan application

## Options

### Accessories

- K28: Articulating Keyboard w/ Mouse - \$390

### Drawer

- P6: Modify File/File to Box/Box/File - \$55 per pedestal
- P33: Wood Drawer Upgrade - \$45 per drawer
- P40W: extra Box/Box/File or File/File to Knee space - \$910
- P40M: extra Box/Box/File or File/File to Knee space - \$720
- WPD3061: Designer White - \$80 per pedestal

### Feet

- D8: Delete feet (extend fronts to floor) - n/c

### Flush Cut

- FC-L: Flush Unit Left (Facing) for Ganging - \$55
- FC-R: Flush Unit Right(Facing) for Ganging - \$55

### Grommets (Non-Standard Location)

Provide drawing w/ Grommet Location and Specify Color - \$95 ea.

- Black: TM30-NS
- Silver: TM31-NS
- White: TM34-NS

### Modesty

- M34T: Drop Door Tech Modesty - \$130
- M34TM: "M" Style Drop Door Tech Modesty - \$130
- M51: Open Back Modesty with Wire Mgmt Rail - Deduct \$95

### Open Plan \_ Finished Back

- OPB: "W" "G" Style - Modify Unit for Open Plan Application - \$295

### Premium Finish Option

- Specify foot Metal Finish color - \$30/Foot (4 total feet)
- MFB: Black, MFW: White, MFDB: Dark Bronze, MFGM: Matte Gold

## 2 Select Finish

[Click to view finishes](#)

[Click to view finishes](#)

[Click to view finishes](#)

[Click to view finishes](#)

## 3 Select Edge



## 4 Select Hardware



# NOT SO square office

"L" Workstation Returns  
Lateral File

[Click here to view statement of line](#)

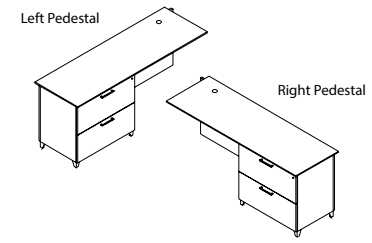

## 1 Select Model

w" x d" x h"	Weight
Left Pedestal	
72 x 22 x 29	200
66 x 22 x 29	190
60 x 22 x 29	180
54 x 22 x 29	170
48 x 22 x 29	165
Right Pedestal	
72 x 22 x 29	200
66 x 22 x 29	190
60 x 22 x 29	180
54 x 22 x 29	170
48 x 22 x 29	165

Standard Veneer Top Standard Veneer Chassis		Premium Veneer Top Premium Veneer Chassis		High Pressure Laminate Top Veneer Chassis		High Pressure Laminate Top Thermally Fused Laminate Chassis	
NSS7222RE187W	3902	NSS7222RE187P	4293	NSS7222RE187G	3902	NSS7222RE187M	2342
NSS6622RE187W	3867	NSS6622RE187P	4255	NSS6622RE187G	3867	NSS6622RE187M	2248
NSS6022RE187W	3810	NSS6022RE187P	4190	NSS6022RE187G	3810	NSS6022RE187M	2156
NSS5422RE187W	3774	NSS5422RE187P	4152	NSS5422RE187G	3774	NSS5422RE187M	2069
NSS4822RE187W	3682	NSS4822RE187P	4050	NSS4822RE187G	3682	NSS4822RE187M	2002
NSS7222RE188W	3902	NSS7222RE188P	4293	NSS7222RE188G	3902	NSS7222RE188M	2342
NSS6622RE188W	3867	NSS6622RE188P	4255	NSS6622RE188G	3867	NSS6622RE188M	2248
NSS6022RE188W	3810	NSS6022RE188P	4190	NSS6022RE188G	3810	NSS6022RE188M	2156
NSS5422RE188W	3774	NSS5422RE188P	4152	NSS5422RE188G	3774	NSS5422RE188M	2069
NSS4822RE188W	3682	NSS4822RE188P	4050	NSS4822RE188G	3682	NSS4822RE188M	2002

## 2 Select Finish

[Click to view finishes](#)

[Click to view finishes](#)

[Click to view finishes](#)

[Click to view finishes](#)

## 3 Select Edge



## 4 Select Hardware



## Product Features

- Full modesty panel
- Standard Silver Feet (optional White, Black)
- Standard metal grommet matches pull finish
- Features ball bearing suspensions, suspensions are full extension

## Notes

- Keyboard not available on noted 48" /54" units. Returns with Grommets in top will automatically have wire channel and outfeed holes in back.
- Laminate version "M" standard w/ open plan back
- Unit not designed for open plan use. Select OPB for Open Plan application

## Options

### Accessories

- K28: Articulating Keyboard w/ Mouse - \$390

### Drawer

- P33: Wood Drawer Upgrade - \$45 per drawer
- P40W: extra Box/Box/File or File/File to Knee space - \$910
- P40M: extra Box/Box/File or File/File to Knee space - \$720
- WPD3061: Designer White - \$80 per pedestal

### Feet

- D8: Delete feet (extend fronts to floor) - n/c

### Flush Cut

- FC-L: Flush Unit Left (Facing) for Ganging - \$55
- FC-R: Flush Unit Right(Facing) for Ganging - \$55

### Grommets (Non-Standard Location)

- Provide drawing w/ Grommet Location and Specify Color - \$95 ea.
- Black: TM30-NS
- Silver: TM31-NS
- White: TM34-NS

### Modesty

- M34T: Drop Door Tech Modesty - \$130
- M34TM: "M" Style Drop Door Tech Modesty - \$130
- M51: Open Back Modesty with Wire Mgmt Rail - Deduct \$95

### Open Plan \_ Finished Back

- OPB: "W" "G" Style - Modify Unit for Open Plan Application - \$295

### Premium Finish Option

- Specify foot Metal Finish color - \$30/Foot (4 total feet)
- MFB: Black, MFW: White, MFDB: Dark Bronze, MFGM: Matte Gold

# NOT SO square office

"L" Workstation Returns  
Multi-File

[Click here to view statement of line](#)

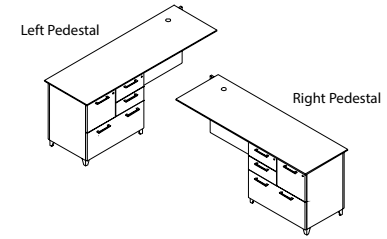

## 1 Select Model

w" x d" x h"  
Left Pedestal  
72 x 22 x 29  
66 x 22 x 29  
60 x 22 x 29  
54 x 22 x 29  
48 x 22 x 29  
Right Pedestal  
72 x 22 x 29  
66 x 22 x 29  
60 x 22 x 29  
54 x 22 x 29  
48 x 22 x 29

Weight	Standard Veneer Top Standard Veneer Chassis		Premium Veneer Top Premium Veneer Chassis		High Pressure Laminate Top Veneer Chassis		High Pressure Laminate Top Thermally Fused Laminate Chassis	
200	NSS7222RE218W	4009	NSS7222RE218P	4411	NSS7222RE218G	4009	NSS7222RE218M	2475
190	NSS6622RE218W	3975	NSS6622RE218P	4373	NSS6622RE218G	3975	NSS6622RE218M	2383
180	NSS6022RE218W	3919	NSS6022RE218P	4311	NSS6022RE218G	3919	NSS6022RE218M	2287
170	NSS5422RE218W	3882	NSS5422RE218P	4271	NSS5422RE218G	3882	NSS5422RE218M	2204
165	NSS4822RE218W	3788	NSS4822RE218P	4167	NSS4822RE218G	3788	NSS4822RE218M	2351
200	NSS7222RE219W	4009	NSS7222RE219P	4411	NSS7222RE219G	4009	NSS7222RE219M	2475
190	NSS6622RE219W	3975	NSS6622RE219P	4373	NSS6622RE219G	3975	NSS6622RE219M	2383
180	NSS6022RE219W	3919	NSS6022RE219P	4311	NSS6022RE219G	3919	NSS6022RE219M	2287
170	NSS5422RE219W	3882	NSS5422RE219P	4271	NSS5422RE219G	3882	NSS5422RE219M	2204
165	NSS4822RE219W	3788	NSS4822RE219P	4167	NSS4822RE219G	3788	NSS4822RE219M	2351

## 2 Select Finish

[Click to view finishes](#)

[Click to view finishes](#)

[Click to view finishes](#)

[Click to view finishes](#)

## 3 Select Edge



## 4 Select Hardware



## Product Features

- Full modesty panel
- Standard Silver Feet (optional White, Black)
- Standard metal grommet matches pull finish
- Pedestal is 31" W
- iWi & iGi Box and File Drawers feature soft close suspensions (Lateral Drawers Feature ball bearing suspensions), iMi SKUs feature ball bearing suspensions. Both suspensions are full extension

## Notes

- Keyboard not available on noted 48" /54" units. Returns with Grommets in top will automatically have wire channel and outfeed holes in back.
- Laminate version "M" standard w/ open plan back
- Unit not designed for open plan use. Select OPB for Open Plan application

## Options

### Accessories

- K28: Articulating Keyboard w/ Mouse - \$390

### Drawer

- P33: Wood Drawer Upgrade - \$45 per drawer
- P40W: extra Box/Box/File or File/File to Knee space - \$910
- P40M: extra Box/Box/File or File/File to Knee space - \$720
- WPD3061: Designer White - \$80 per pedestal

### Feet

- D8: Delete feet (extend fronts to floor) - n/c

### Flush Cut

- FC-L: Flush Unit Left (Facing) for Ganging - \$55
- FC-R: Flush Unit Right(Facing) for Ganging - \$55

### Grommets (Non-Standard Location)

Provide drawing w/ Grommet Location and Specify Color - \$95 ea.

- Black: TM30-NS
- Silver: TM31-NS
- White: TM34-NS

### Modesty

- M34T: Drop Door Tech Modesty - \$130
- M34TM: "M" Style Drop Door Tech Modesty - \$130
- M51: Open Back Modesty with Wire Mgmt Rail - Deduct \$95

### Open Plan \_ Finished Back

- OPB: "W" "G" Style - Modify Unit for Open Plan Application - \$295

### Premium Finish Option

- Specify foot Metal Finish color - \$30/Foot (4 total feet)
- MFB: Black, MFW: White, MFDB: Dark Bronze, MFGM: Matte Gold



# NOT SO square office

Workstation Bridges  
Open Back Bridge

[Click here to view statement of line](#)

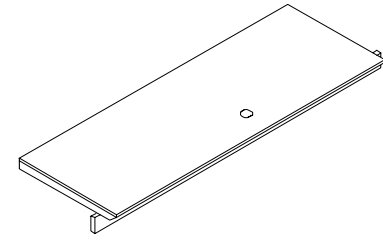

## 1 Select Model

w" x d" x h"	Weight
48 x 22 x 29	55
42 x 22 x 29	391
36 x 22 x 29	363

Standard Veneer Top Standard Veneer Chassis		Premium Veneer Top Premium Veneer Chassis		High Pressure Laminate Top Veneer Chassis		High Pressure Laminate Top Thermally Fused Laminate Chassis	
--	--	--	--	--	--	--	--

NSS4822BR151W	776	NSS4822BR151P	854	NSS4822BR151G	776	NSS4822BR151M	650
NSS4222BR151W	733	NSS4222BR151P	806	NSS4222BR151G	733	NSS4222BR151M	617
NSS3622BR151W	697	NSS3622BR151P	766	NSS3622BR151G	697	NSS3622BR151M	573

## Product Features

- Metal grommet matches pull finish
- Standard open back 4" wire management rail

## Options

### Accessories

- K28: Articulating Keyboard w/ Mouse - \$390
- K31: Center Drawer - \$205

### Grommets (Non-Standard Location)

Provide drawing w/ Grommet Location and Specify Color - \$95 ea.

- Black: TM30-NS
- Silver: TM31-NS
- White: TM34-NS

### Modesty

- M34T: Drop Door Tech Modesty - \$130
- M34TM: "M" Style Drop Door Tech Modesty - \$130
- M37: "W" "G" Style Fixed Full Modesty - \$130
- M37M: "M" Style Fixed Full Modesty - \$80

## 2 Select Finish

[Click to view finishes](#)

[Click to view finishes](#)

[Click to view finishes](#)

[Click to view finishes](#)

## 3 Select Edge



## 4 Select Hardware

Hardware  
N/A

Hardware  
N/A

Hardware  
N/A

Hardware  
N/A

# NOT SO square office

Freestanding Lateral File Credenzas  
Lateral File/Storage

[Click here to view statement of line](#)

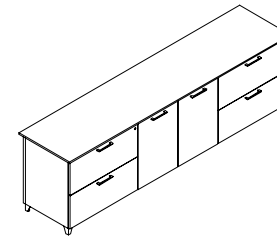

## 1 Select Model

w" x d" x h"  
95 x 22 x 29  
89 x 22 x 29

Weight

Standard Veneer Top Standard Veneer Chassis		Premium Veneer Top Premium Veneer Chassis		High Pressure Laminate Top Veneer Chassis		High Pressure Laminate Top Thermally Fused Laminate Chassis	
NSS9522CA651W	5688	NSS9522CA651P	6257	NSS9522CA651G	5688	NSS9522CA651M	4366
NSS8922CA651W	5598	NSS8922CA651P	6158	NSS8922CA651G	5598	NSS8922CA651M	4232

## 2 Select Finish

[Click to view finishes](#)

[Click to view finishes](#)

[Click to view finishes](#)

[Click to view finishes](#)

## 3 Select Edge



## 4 Select Hardware



## Product Features

- Full height storage has black laminate adjustable shelf
- Full extension drawers - locking
- Features ball bearing suspensions, suspensions are full extension
- Standard Silver Feet (optional White, Black)

## Notes

- Unit has black back panel and is not designed for Open Plan use. Select OPB Option for Open Plan application

## Options

### Door

- D2: Door Lock per door set - \$100
- D6A: "W"/"G" Styles - Delete Doors and replace black laminate shelf with finished shelf - n/c
- D9SC: Soft Close Door Hinges - \$20 per door

### Drawer

- P33: Wood Drawer Upgrade - \$45 per drawer
- WPD3061: Designer White - \$80 per pedestal

### Feet

- D8: Delete feet (extend fronts to floor) - n/c

### Flush Cut

- FC-B: Flush Unit Both Sides(Facing) for Ganging - \$55
- FC-L: Flush Unit Left (Facing) for Ganging - \$55
- FC-R: Flush Unit Right(Facing) for Ganging - \$55

### Grommets (Standard Location)

- Specify Color and Location (Right/Left/Center) - \$50 ea.
- Black: TM30-R (Right), TM30-L (Left), TM30-C (Center)
  - Silver: TM31-R (Right), TM31-L (Left), TM31-C (Center)
  - White: TM34-R (Right), TM34-L (Left), TM34-C (Center)

### Grommets (Non-Standard Location)

- Provide drawing w/ Grommet Location and Specify Color - \$95 ea.
- Black: TM30-NS
  - Silver: TM31-NS
  - White: TM34-NS

### Open Plan \_ Finished Back

- OPB: "W" "G" Style - Modify Unit for Open Plan Application - \$295

### Shelf

- S714F: Heavy Duty Lumber 1" Shelves - \$80 per shelf ("M" Styles - n/a)

### Premium Finish Option

- Specify foot Metal Finish color - \$30/Foot (8 feet total)
- MFB: Black, MFW: White, MFDB: Dark Bronze, MFGM: Matte Gold

# NOT SO square office

File Credenzas  
File/File/Kneespace

[Click here to view statement of line](#)

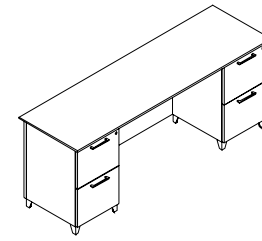

## 1 Select Model

w" x d" x h"	Weight
84 x 22 x 29	240
72 x 22 x 29	220
66 x 24 x 29	210
60 x 24 x 29	200

	Standard Veneer Top Standard Veneer Chassis		Premium Veneer Top Premium Veneer Chassis		High Pressure Laminate Top Veneer Chassis		High Pressure Laminate Top Thermally Fused Laminate Chassis	
	NSS8422CA054W	4532	NSS8422CA054P	4986	NSS8422CA054G	4532	NSS8422CA054M	2987
	NSS7222CA054W	4196	NSS7222CA054P	4617	NSS7222CA054G	4196	NSS7222CA054M	2791
	NSS6622CA054W	4152	NSS6622CA054P	4568	NSS6622CA054G	4152	NSS6622CA054M	2738
	NSS6022CA054W	4111	NSS6022CA054P	4523	NSS6022CA054G	4111	NSS6022CA054M	2698

## 2 Select Finish

[Click to view finishes](#)

[Click to view finishes](#)

[Click to view finishes](#)

[Click to view finishes](#)

## 3 Select Edge



## 4 Select Hardware



## Product Features

- Full modesty back
- Full extension drawers - locking
- Soft close suspension drawer(s)
- Standard Silver Feet (optional White, Black)

## Notes

- If a grommet is located in top surface over open knee space, an outfeed hole will be provided in modesty panel
- Unit has black back panel and is not designed for Open Plan use. Select OPB Option for Open Plan application

## Options

### Accessories

- K28: Articulating Keyboard w/ Mouse - \$390

### Drawer

- P6: Modify File/File to Box/Box/File - \$55 per pedestal
- P33: Wood Drawer Upgrade - \$45 per drawer
- WPD3061: Designer White - \$80 per pedestal

### Feet

- D8: Delete feet (extend fronts to floor) - n/c

### Flush Cut

- FC-B: Flush Unit Both Sides(Facing) for Ganging - \$55
- FC-L: Flush Unit Left (Facing) for Ganging - \$55
- FC-R: Flush Unit Right(Facing) for Ganging - \$55

### Grommets (Standard Location)

- Specify Color - \$50 ea.
- Black: TM30-C (Center)
  - Silver: TM31-C (Center)
  - White: TM34-C (Center)

### Grommets (Non-Standard Location)

Provide drawing w/ Grommet Location and Specify Color - \$95 ea.

- Black: TM30-NS
- Silver: TM31-NS
- White: TM34-NS

### Modesty

- M34T: Drop Door Tech Modesty - \$130
- M34TM: "M" Style Drop Door Tech Modesty - \$130
- M51: Open Back Modesty with Wire Mgmt Rail - Deduct \$95

### Open Plan \_ Finished Back

- OPB: "W" "G" Style - Modify Unit for Open Plan Application - \$295

### Premium Finish Option

- Specify foot Metal Finish color - \$30/Foot (8 feet total)
- MFB: Black, MFW: White, MFDB: Dark Bronze, MFGM: Matte Gold

# NOT SO square office

Freestanding Storage Credenzas  
Storage

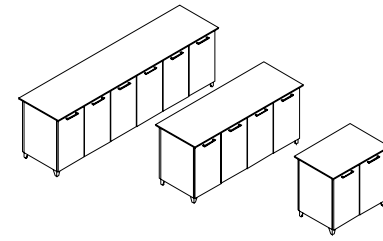

[Click here to view statement of line](#)

## 1 Select Model

w" x d" x h"  
3 Section  
95 x 22 x 29  
89 x 22 x 29  
2 Section  
72 x 22 x 29  
60 x 22 x 29  
1 Section  
37 x 22 x 29  
31 x 22 x 29

Weight

		Standard Veneer Top Standard Veneer Chassis		Premium Veneer Top Premium Veneer Chassis		High Pressure Laminate Top Veneer Chassis		High Pressure Laminate Top Thermally Fused Laminate Chassis	
		NSS9522CA125W	5477	NSS9522CA125P	6026	NSS9522CA125G	5477	NSS9522CA125M	3831
	325	NSS8922CA125W	5385	NSS8922CA125P	5924	NSS8922CA125G	5385	NSS8922CA125M	3732
	300	NSS7222CA125W	4398	NSS7222CA125P	4838	NSS7222CA125G	4398	NSS7222CA125M	2818
	275	NSS6022CA125W	4268	NSS6022CA125P	4696	NSS6022CA125G	4268	NSS6022CA125M	2745
	250	NSS3722CA125W	2351	NSS3722CA125P	2588	NSS3722CA125G	2351	NSS3722CA125M	1513
	145	NSS3122CA125W	2221	NSS3122CA125P	2443	NSS3122CA125G	2221	NSS3122CA125M	1471
	135								

## 2 Select Finish

[Click to view finishes](#)

[Click to view finishes](#)

[Click to view finishes](#)

[Click to view finishes](#)

## 3 Select Edge



## 4 Select Hardware



## Product Features

- Full height storage has 1 adjustable black laminate shelf per section
- Standard Silver Feet (optional White, Black)

## Notes

- Unit has black back panel and is not designed for Open Plan use. Select OPB Option for Open Plan application

## Options

### Door

- D2: Door lock (only available in panel door) - \$100 per door set
- D6A: "W"/"G" Styles - Delete Doors and replace black laminate shelf with finished shelf - n/c
- D9SC: Soft Close Door Hinges - \$20 per door
- WPD3061: Designer White - \$80 per door

### Feet

- D8: Delete feet (extend fronts to floor) - n/c

### Flush Cut

- FC-B: Flush Unit Both Sides(Facing) for Ganging - \$55
- FC-L: Flush Unit Left (Facing) for Ganging - \$55
- FC-R: Flush Unit Right(Facing) for Ganging - \$55

### Grommets (Standard Location)

- Specify Color and Location (Right/Left/Center) - \$50 ea.
- Black: TM30-R (Right), TM30-L (Left), TM30-C (Center)
  - Silver: TM31-R (Right), TM31-L (Left), TM31-C (Center)
  - White: TM34-R (Right), TM34-L (Left), TM34-C (Center)

### Grommets (Non-Standard Location)

- Provide drawing w/ Grommet Location and Specify Color - \$95 ea.
- Black: TM30-NS
  - Silver: TM31-NS
  - White: TM34-NS

### Grommets (Vertical Surface)

- Standard Location - \$50 ea.
- Black Plastic Vertical Surface: TM50-C (Bottom Center)
- Non-Standard Location - \$95 ea.
- Black Plastic Vertical Surface: TM50-NS

### Open Plan \_ Finished Back

- OPB: "W" "G" Style - Modify Unit for Open Plan Application - \$295

### Premium Finish Option

- Specify foot Metal Finish color - \$30 / foot (4 Feet)
- MFB: Black, MFW: White

# NOT SO square office

Freestanding Lateral File Credenzas  
Horizontal Lateral File

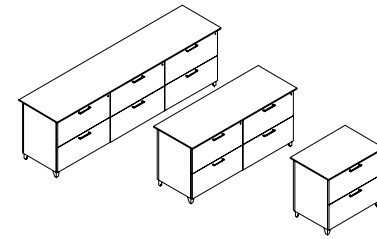

[Click here to view statement of line](#)

## 1 Select Model

w" x d" x h"	Weight
6 Drawer	
95 x 22 x 29	370
89 x 22 x 29	350
4 Drawer	
72 x 22 x 29	315
60 x 22 x 29	275
2 Drawer	
43 x 22 x 29	175
37 x 22 x 29	160
31 x 22 x 29	150

Standard Veneer Top Standard Veneer Chassis		Premium Veneer Top Premium Veneer Chassis		High Pressure Laminate Top Veneer Chassis		High Pressure Laminate Top Thermally Fused Laminate Chassis	
NSS9522CA104W	5787	NSS9522CA104P	6366	NSS9522CA104G	5787	NSS9522CA104M	5787
NSS8922CA104W	5705	NSS8922CA104P	6277	NSS8922CA104G	5705	NSS8922CA104M	4318
NSS7222CA104W	4597	NSS7222CA104P	5059	NSS7222CA104G	4597	NSS7222CA104M	3306
NSS6022CA104W	4469	NSS6022CA104P	4917	NSS6022CA104G	4469	NSS6022CA104M	3216
NSS4322CA104W	2680	NSS4322CA104P	2947	NSS4322CA104G	2680	NSS4322CA104M	2092
NSS3722CA104W	2443	NSS3722CA104P	2688	NSS3722CA104G	2443	NSS3722CA104M	1934
NSS3122CA104W	2351	NSS3122CA104P	2586	NSS3122CA104G	2351	NSS3122CA104M	1881

## 2 Select Finish

[Click to view finishes](#)

[Click to view finishes](#)

[Click to view finishes](#)

[Click to view finishes](#)

## 3 Select Edge



## 4 Select Hardware



## Product Features

- Anti-tip safety feature (31"-72")
- Full extension drawers - locking
- Features ball bearing suspensions, suspensions are full extension
- Standard Silver Feet (optional White, Black)

## Notes

- Unit has black back panel and is not designed for Open Plan use. Select OPB Option for Open Plan application

## Options

### Drawer

- P33: Wood Drawer Upgrade - \$45 per drawer
- WPD3061: Designer White - \$80 per pedestal

### Feet

- D8: Delete feet (extend fronts to floor) - n/c

### Flush Cut

- FC-B: Flush Unit Both Sides(Facing) for Ganging - \$55
- FC-L: Flush Unit Left (Facing) for Ganging - \$55
- FC-R: Flush Unit Right(Facing) for Ganging - \$55

### Open Plan \_ Finished Back

- OPB: "W" "G" Style - Modify Unit for Open Plan Application - \$295

### Premium Finish Option

- Specify foot Metal Finish color - \$30 / foot (4 Feet)
- MFB: Black, MFW: White

# NOT SO square office

Freestanding Lateral File Credenzas  
Vertical Lateral File

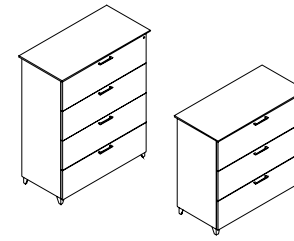

[Click here to view statement of line](#)

## 1 Select Model

w" x d" x h"	Weight
4 Drawer	
43 x 22 x 54	290
37 x 22 x 54	270
31 x 22 x 54	245
3 Drawer	
43 x 22 x 42	255
37 x 22 x 42	235
31 x 22 x 42	215

Standard Veneer Top Standard Veneer Chassis		Premium Veneer Top Premium Veneer Chassis		High Pressure Laminate Top Veneer Chassis		High Pressure Laminate Top Thermally Fused Laminate Chassis	
NSS4322F111W	4911	NSS4322F111P	5403	NSS4322F111G	4911	NSS4322F111M	3147
NSS3722F111W	4640	NSS3722F111P	5105	NSS3722F111G	4640	NSS3722F111M	2888
NSS3122F111W	4469	NSS3122F111P	4917	NSS3122F111G	4469	NSS3122F111M	2792
NSS4322F112W	4568	NSS4322F112P	5024	NSS4322F112G	4568	NSS4322F112M	2862
NSS3722F112W	4311	NSS3722F112P	4742	NSS3722F112G	4311	NSS3722F112M	2594
NSS3122F112W	4152	NSS3122F112P	4568	NSS3122F112G	4152	NSS3122F112M	2515

## Product Features

- Anti-tip safety feature
- Full extension drawers - locking
- Features ball bearing suspensions, suspensions are full extension
- Standard Silver Feet (optional White, Black)

## Notes

- Unit has black back panel and is not designed for Open Plan use. Select OPB Option for Open Plan application

## Options

### Drawer

- P33: Wood Drawer Upgrade - \$45 per drawer
- WPD3061: Designer White - \$80 per pedestal

### Feet

- D8: Delete feet (extend fronts to floor) - n/c

### Flush Cut

- FC-B: Flush Unit Both Sides(Facing) for Ganging - \$55
- FC-L: Flush Unit Left (Facing) for Ganging - \$55
- FC-R: Flush Unit Right(Facing) for Ganging - \$55

### Open Plan \_ Finished Back

- OPB: "W" "G" Style - Modify Unit for Open Plan Application - \$295

### Premium Finish Option

- Specify foot Metal Finish color - \$30 / foot (4 Feet)
- MFB: Black, MFW: White

## 2 Select Finish

[Click to view finishes](#)

[Click to view finishes](#)

[Click to view finishes](#)

[Click to view finishes](#)

## 3 Select Edge



## 4 Select Hardware



# NOT SO square office

Workstation Credenzas  
File/File

[Click here to view statement of line](#)

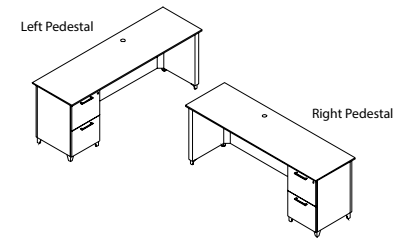

## 1 Select Model

w" x d" x h"	Weight
Left Pedestal	
89 x 22 x 29	220
84 x 22 x 29	210
72 x 22 x 29	200
66 x 22 x 29	190
Right Pedestal	
89 x 22 x 29	220
84 x 22 x 29	210
72 x 22 x 29	200
66 x 22 x 29	190

Standard Veneer Top Standard Veneer Chassis		Premium Veneer Top Premium Veneer Chassis		High Pressure Laminate Top Veneer Chassis		High Pressure Laminate Top Thermally Fused Laminate Chassis	
NSS8922CA086W	4383	NSS8922CA086P	4821	NSS8922CA086G	4383	NSS8922CA086M	2790
NSS8422CA086W	4311	NSS8422CA086P	4742	NSS8422CA086G	4311	NSS8422CA086M	2602
NSS7222CA086W	3980	NSS7222CA086P	4379	NSS7222CA086G	3980	NSS7222CA086M	2410
NSS6622CA086W	3938	NSS6622CA086P	4333	NSS6622CA086G	3938	NSS6622CA086M	2348
NSS8922CA087W	4383	NSS8922CA087P	4821	NSS8922CA087G	4383	NSS8922CA087M	2790
NSS8422CA087W	4311	NSS8422CA087P	4742	NSS8422CA087G	4311	NSS8422CA087M	2602
NSS7222CA087W	3980	NSS7222CA087P	4379	NSS7222CA087G	3980	NSS7222CA087M	2410
NSS6622CA087W	3938	NSS6622CA087P	4333	NSS6622CA087G	3938	NSS6622CA087M	2348

## Product Features

- Full modesty back
- Full extension drawers - locking
- Outfeed hole standard in back of credenza
- Soft close suspension drawer(s)
- Standard metal grommet matches pull finish
- Standard Silver Feet (optional White, Black)

## Notes

- Laminate version "M" standard w/ open plan back
- Unit has black back panel and is not designed for Open Plan use. Select OPB Option for Open Plan application

## Options

### Accessories

- K28: Articulating Keyboard w/ Mouse - \$390

### Drawer

- P6: Modify File/File to Box/Box/File - \$55 per pedestal
- P33: Wood Drawer Upgrade - \$45 per drawer
- P40W: extra Box/Box/File or File/File to Knee space - \$910
- P40M: extra Box/Box/File or File/File to Knee space - \$720
- WPD3061: Designer White - \$80 per door

### Feet

- D8: Delete feet (extend fronts to floor) - n/c

### Flush Cut

- FC-B: Flush Unit Both Sides(Facing) for Ganging - \$55
- FC-L: Flush Unit Left (Facing) for Ganging - \$55
- FC-R: Flush Unit Right(Facing) for Ganging - \$55

### Grommets (Non-Standard Location)

Provide drawing w/ Grommet Location and Specify Color - \$95 ea.

- Black: TM30-NS
- Silver: TM31-NS
- White: TM34-NS

### Modesty

- M34T: Drop Door Tech Modesty - \$130
- M34TM: "M" Style Drop Door Tech Modesty - \$130
- M51: Open Back Modesty with Wire Mgmt Rail - Deduct \$95

### Open Plan \_ Finished Back

- OPB: "W" "G" Style - Modify Unit for Open Plan Application - \$195

### Premium Finish Option

- Specify foot Metal Finish color - \$30 / foot (6 Feet)
- MFB: Black, MFW: White, MFDB: Dark Bronze, MFGM: Matte Gold

## 2 Select Finish

[Click to view finishes](#)

[Click to view finishes](#)

[Click to view finishes](#)

[Click to view finishes](#)

## 3 Select Edge



## 4 Select Hardware

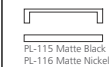
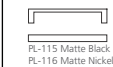



# NOT SO square office

Workstation Credenzas  
Lateral File

[Click here to view statement of line](#)

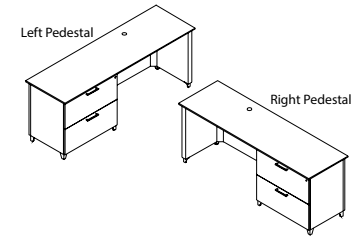

## 1 Select Model

w" x d" x h"	Weight
<b>Left Pedestal</b>	
95 x 22 x 29	265
89 x 22 x 29	250
84 x 22 x 29	240
72 x 22 x 29	230
66 x 22 x 29	215
<b>Right Pedestal</b>	
95 x 22 x 29	265
89 x 22 x 29	250
84 x 22 x 29	240
72 x 22 x 29	230
66 x 22 x 29	215

Standard Veneer Top Standard Veneer Chassis		Premium Veneer Top Premium Veneer Chassis		High Pressure Laminate Top Veneer Chassis		High Pressure Laminate Top Thermally Fused Laminate Chassis	
NSS9522CA066W	4605	NSS9522CA066P	5067	NSS9522CA066G	4605	NSS9522CA066M	3073
NSS8922CA066W	4555	NSS8922CA066P	5011	NSS8922CA066G	4555	NSS8922CA066M	2920
NSS8422CA066W	4412	NSS8422CA066P	4854	NSS8422CA066G	4412	NSS8422CA066M	2742
NSS7222CA066W	4126	NSS7222CA066P	4539	NSS7222CA066G	4126	NSS7222CA066M	2563
NSS6622CA066W	4083	NSS6622CA066P	4492	NSS6622CA066G	4083	NSS6622CA066M	2503
NSS9522CA067W	4605	NSS9522CA067P	5067	NSS9522CA067G	4605	NSS9522CA067M	3073
NSS8922CA067W	4555	NSS8922CA067P	5011	NSS8922CA067G	4555	NSS8922CA067M	2920
NSS8422CA067W	4412	NSS8422CA067P	4854	NSS8422CA067G	4412	NSS8422CA067M	2742
NSS7222CA067W	4126	NSS7222CA067P	4539	NSS7222CA067G	4126	NSS7222CA067M	2563
NSS6622CA067W	4083	NSS6622CA067P	4492	NSS6622CA067G	4083	NSS6622CA067M	2503

## Product Features

- All drawers lock
- Full modesty back
- Outfeed hole standard in back of credenza
- Features ball bearing suspensions, suspensions are full extension
- Standard metal grommet matches pull finish
- Standard Silver Feet (optional White, Black)

## Notes

- 96, 90, 84 W units have 35W lateral
- 72 and 66 W units have 29W lateral
- Keyboard not available on 66"W Lateral File/Multi-File Units
- Unit has black back panel and is not designed for Open Plan use. Select OPB Option for Open Plan application

## 2 Select Finish

[Click to view finishes](#)

[Click to view finishes](#)

[Click to view finishes](#)

[Click to view finishes](#)

## 3 Select Edge



## 4 Select Hardware

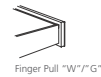
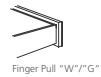
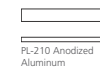
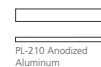
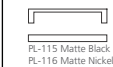
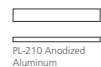
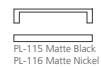

## Options

### Accessories

- K28: Articulating Keyboard w/ Mouse - \$390

### Drawer

- P33: Wood Drawer Upgrade - \$45 per drawer
- P40W: extra Box/Box/File or File/File to Knee space - \$910 (n/a on 66")
- P40M: extra Box/Box/File or File/File to Knee space - \$720 (n/a on 66")
- WPD3061: Designer White - \$80 per door

### Feet

- D8: Delete feet (extend fronts to floor) - n/c

### Flush Cut

- FC-B: Flush Unit Both Sides(Facing) for Ganging - \$55
- FC-L: Flush Unit Left (Facing) for Ganging - \$55
- FC-R: Flush Unit Right(Facing) for Ganging - \$55

### Grommets (Non-Standard Location)

Provide drawing w/ Grommet Location and Specify Color - \$95 ea.

- Black: TM30-NS
- Silver: TM31-NS
- White: TM34-NS

### Modesty

- M34T: Drop Door Tech Modesty - \$130
- M34TM: "M" Style Drop Door Tech Modesty - \$130
- M51: Open Back Modesty with Wire Mgmt Rail - Deduct \$95

### Open Plan \_ Finished Back

- OPB: "W" "G" Style - Modify Unit for Open Plan Application - \$195

### Premium Finish Option

- Specify foot Metal Finish color - \$30 / foot (6 Feet)
- MFB: Black, MFW: White, MFDB: Dark Bronze, MFGM: Matte Gold

# NOT SO square office

Workstation Credenzas  
Multi-File

[Click here to view statement of line](#)

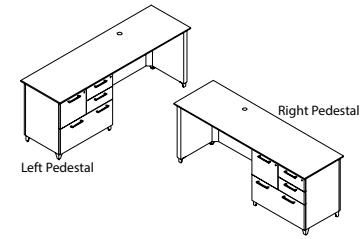

## 1 Select Model

w" x d" x h"	Weight
Left Pedestal	
95 x 22 x 29	265
89 x 22 x 29	250
84 x 22 x 29	240
72 x 22 x 29	230
*66 x 22 x 29	215
Right Pedestal	
95 x 22 x 29	265
89 x 22 x 29	250
84 x 22 x 29	240
72 x 22 x 29	230
*66 x 22 x 29	215

Standard Veneer Top Standard Veneer Chassis		Premium Veneer Top Premium Veneer Chassis		High Pressure Laminate Top Veneer Chassis		High Pressure Laminate Top Thermally Fused Laminate Chassis	
NSS9522CA667W	4709	NSS9522CA667P	5181	NSS9522CA667G	4709	NSS9522CA667M	3102
NSS8922CA667W	4662	NSS8922CA667P	5129	NSS8922CA667G	4662	NSS8922CA667M	3060
NSS8422CA667W	4520	NSS8422CA667P	4972	NSS8422CA667G	4520	NSS8422CA667M	2882
NSS7222CA667W	4232	NSS7222CA667P	4656	NSS7222CA667G	4232	NSS7222CA667M	2701
NSS6622CA667W	4190	NSS6622CA667P	4609	NSS6622CA667G	4190	NSS6622CA667M	2643
NSS9522CA668W	4709	NSS9522CA668P	5181	NSS9522CA668G	4709	NSS9522CA668M	3102
NSS8922CA668W	4662	NSS8922CA668P	5129	NSS8922CA668G	4662	NSS8922CA668M	3060
NSS8422CA668W	4520	NSS8422CA668P	4972	NSS8422CA668G	4520	NSS8422CA668M	2882
NSS7222CA668W	4232	NSS7222CA668P	4656	NSS7222CA668G	4232	NSS7222CA668M	2701
NSS6622CA668W	4190	NSS6622CA668P	4609	NSS6622CA668G	4190	NSS6622CA668M	2643

## 2 Select Finish

[Click to view finishes](#)

[Click to view finishes](#)

[Click to view finishes](#)

[Click to view finishes](#)

## 3 Select Edge



## 4 Select Hardware



## Product Features

- Full modesty back
- Outfeed hole standard in back of credenza
- iWi & iGi Box and File Drawers feature soft close suspensions (Lateral Drawers Feature ball bearing suspensions), iMi SKUs feature ball bearing suspensions. Both suspensions are full extension
- Standard metal grommet matches pull finish
- Standard Silver Feet (optional White, Black)

## Notes

- Keyboard not available on 66"W Lateral File/Multi-File Units
- Unit not designed for open plan use. Select OPB for Open Plan application

## Options

### Accessories

- K28: Articulating Keyboard w/ Mouse - \$390

### Drawer

- P33: Wood Drawer Upgrade - \$45 per drawer
- P40W: extra Box/Box/File or File/File to Knee space - \$910 (n/a on 66")
- P40M: extra Box/Box/File or File/File to Knee space - \$720 (n/a on 66")
- WPD3061: Designer White - \$80 per door

### Feet

- D8: Delete feet (extend fronts to floor) - n/c

### Flush Cut

- FC-B: Flush Unit Both Sides(Facing) for Ganging - \$55
- FC-L: Flush Unit Left (Facing) for Ganging - \$55
- FC-R: Flush Unit Right(Facing) for Ganging - \$55

### Grommets (Non-Standard Location)

Provide drawing w/ Grommet Location and Specify Color - \$95 ea.

- Black: TM30-NS
- Silver: TM31-NS
- White: TM34-NS

### Modesty

- M34T: Drop Door Tech Modesty - \$130
- M34TM: "M" Style Drop Door Tech Modesty - \$130
- M51: Open Back Modesty with Wire Mgmt Rail - Deduct \$95

### Open Plan \_ Finished Back

- OPB: "W" "G" Style - Modify Unit for Open Plan Application - \$195

### Premium Finish Option

- Specify foot Metal Finish color - \$30 / foot (6 Feet)
- MFB: Black, MFW: White, MFDB: Dark Bronze, MFGM: Matte Gold

# NOT SO square office

Bench Cabinets  
One / Two / Three Section Storage

[Click here to view statement of line](#)

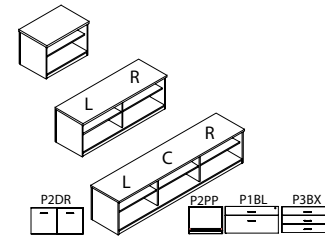

## 1 Select Model

w" x d" x h"  
Three Section  
93.5 x 20 x 23  
87.5 x 20 x 23  
Two Section  
70.5 x 20 x 23  
58.5 x 20 x 23  
One Section  
35.5 x 20 x 23  
29.5 x 20 x 23

Weight

		Standard Veneer Top Standard Veneer Chassis		Premium Veneer Top Premium Veneer Chassis		High Pressure Laminate Top Veneer Chassis		Thermally Fused Laminate Top Thermally Fused Laminate Chassis	
300	NSS9320CA063W	4505	NSS9320CA063P	4957	NSS9320CA063G	4505	NSS9320CA063M	2938	
290	NSS8720CA063W	4168	NSS8720CA063P	4586	NSS8720CA063G	4168	NSS8720CA063M	2649	
225	NSS7020CA063W	2980	NSS7020CA063P	3278	NSS7020CA063G	2980	NSS7020CA063M	2213	
210	NSS5820CA063W	2808	NSS5820CA063P	3090	NSS5820CA063G	2808	NSS5820CA063M	2053	
95	NSS3520CA063W	1568	NSS3520CA063P	1725	NSS3520CA063G	1568	NSS3520CA063M	905	
90	NSS2920CA063W	1527	NSS2920CA063P	1680	NSS2920CA063G	1527	NSS2920CA063M	865	

## 2 Select Finish

[Click to view finishes](#)

[Click to view finishes](#)

[Click to view finishes](#)

[Click to view finishes](#)

## 3 Select Edge

Edge  
N/A

Edge  
N/A

Edge  
N/A

Edge  
N/A

## 4 Select Hardware

Hardware  
N/A

Hardware  
N/A

Hardware  
N/A

Hardware  
N/A

## Product Features

- 1 1/8" top with flat edges
- Open plan - back
- Standard open storage with shelves

## Notes

- To use Runoff Desk with Bench Cabinets, order Bench Runoff Support Ends: see Runoff Desk
- Bench Cushion Top factory installed as specified
- Standard without legs
- For drawers, storage and printer cabinets select options below

## Options

### Cabinet

- P1BL: Box/Lateral File - \$315 M / \$620 W
- P2DR: Storage Door - \$185 M / \$290 W
- P2PP: Open Printer Pullout - \$235 M / \$340 W
- P3BX: Three Box Drawers - \$315 M / \$515 W

### Shelf

- S714F: Heavy Duty Lumber 1" Shelves - \$80 per shelf ("M" Styles - n/a)

### Feet

- MTL50: 4 Silver Feet - \$205

### Grommets (Standard Location)

- Specify Color and Location (Right/Left/Center) - \$50 ea.
- Black: TM30-R (Right), TM30-L (Left), TM30-C (Center)
  - Silver: TM31-R (Right), TM31-L (Left), TM31-C (Center)
  - White: TM34-R (Right), TM34-L (Left), TM34-C (Center)

### Grommets (Non-Standard Location)

- Provide drawing w/ Grommet Location and Specify Color - \$95 ea.
- Black: TM30-NS, Silver: TM31-NS, White: TM34-NS

### Grommets (Vertical Surface)

- Standard Location Black Plastic Vertical Surface: TM50-C (Bottom Center) - \$50 ea.
- Non-Standard Location Black Plastic Vertical Surface: TM50-NS - \$95 ea.

### Cushion

- BC20: Bench Cushion
- Specify location, number of cushions and fabric grade.
- Cushions sold individually w/a max width 35" (to match storage section depth). 29" W requires .75 yd., 35" W requires 1 yd.

### BC20 Bench Cushion fabric grades

COM	COL	1	2	3
240	270	300	320	340
4	5	6	7	8
360	380	420	440	460
9	10	11/ L1	12	13/ L2
480	500	520	540	560

# NOT SO square office

Freestanding Mobile Pedestal  
Mobile Pedestal - Under Surface

[Click here to view statement of line](#)

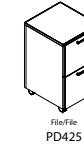
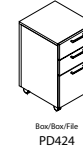

## 1 Select Model

w" x d" x h"  
Box/Box/File  
16 x 18 x 27  
File/File  
16 x 18 x 27  
Box/File  
16 x 18 x 23

Weight	Standard Veneer Top Standard Veneer Chassis	Premium Veneer Top Premium Veneer Chassis	High Pressure Laminate Top Veneer Chassis	Thermally Fused Laminate Top Thermally Fused Laminate Chassis
90	NSS1618PD424W 1492	NSS1618PD424P 1641	"G" Option N/A	NSS1618PD424M 1422
90	NSS1618PD425W 1492	NSS1618PD425P 1641	"G" Option N/A	NSS1618PD425M 1422
90	NSS1618PD423W 1359	NSS1618PD423P 1496	"G" Option N/A	NSS1618PD423M 1314

## Product Features

- Anti-tip safety feature
- For open plan use under surfaces
- Full extension drawers - locking

## Notes

- Pedestal Cushion can be specified on all pedestals, but on Box/ Box/ File and File/File unit will not fit under work surface w/ cushion.

## Options

### Cushion

- BC16: Bench Cushion
- Specify fabric grade (1 yd. required)

### Drawer

- P33: Wood Drawer Upgrade - \$45 per drawer
- WPD3061: Designer White - \$80 per pedestal

### Premium Finish Option

- Specify foot Metal Finish color - \$30 per foot
- MFB: Black, MFW: White

### BC16 Cushion fabric grades

COM	COL	1	2	3
215	N/A	245	260	275
4	5	6	7	8
290	305	320	335	350
9	10	11/ L1	12	13/ L2
365	380	395	410	425

## 2 Select Finish

[Click to view finishes](#)

[Click to view finishes](#)

[Click to view finishes](#)

## 3 Select Edge

Edge  
N/A

Edge  
N/A

Edge  
N/A

## 4 Select Hardware



# NOT SO square office

Single Storage Overhead Consoles  
Panel Door - 6/4/2 Door

[Click here to view statement of line](#)

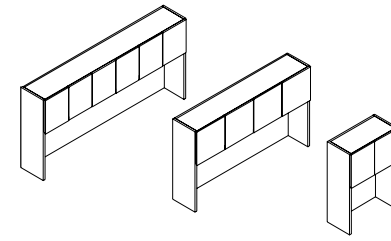

## 1 Select Model

w" x d" x h"	Weight
6 Door / 3 Section	
93 x 14 x 42	315
87 x 14 x 42	285
4 Door / 2 Section	
83 x 14 x 42	275
76 x 14 x 42	255
70 x 14 x 42	240
64 x 14 x 42	225
58 x 14 x 42	210
47 x 14 x 42	190
2 Door / 1 Section	
35 x 14 x 42	120
29 x 14 x 42	105

	Standard Veneer Top Standard Veneer Chassis	Premium Veneer Top Premium Veneer Chassis	High Pressure Laminate Top Veneer Chassis	Thermally Fused Laminate Top Thermally Fused Laminate Chassis
			"G" Option N/A	NSS9342OH325M 3043
	NSS9342OH325W 4562	NSS9342OH325P 5019	"G" Option N/A	NSS8742OH325M 2877
	NSS8742OH325W 4398	NSS8742OH325P 4838		
			"G" Option N/A	NSS8342OH325M 2342
	NSS8342OH325W 3998	NSS8342OH325P 4398	"G" Option N/A	NSS7642OH325M 2252
	NSS7642OH325W 3723	NSS7642OH325P 4097	"G" Option N/A	NSS7042OH325M 1924
	NSS7042OH325W 3453	NSS7042OH325P 3798	"G" Option N/A	NSS6442OH325M 1842
	NSS6442OH325W 3368	NSS6442OH325P 3704	"G" Option N/A	NSS5842OH325M 1769
	NSS5842OH325W 3280	NSS5842OH325P 3609	"G" Option N/A	NSS4742OH325M 1612
	NSS4742OH325W 3110	NSS4742OH325P 3422		
			"G" Option N/A	NSS3542OH325M 1036
	NSS3542OH325W 2034	NSS3542OH325P 2238	"G" Option N/A	NSS2942OH325M 985
	NSS2942OH325W 1977	NSS2942OH325P 2176		

## 2 Select Finish

[Click to view finishes](#)

[Click to view finishes](#)

[Click to view finishes](#)

## 3 Select Edge

Edge  
N/A

Edge  
N/A

Edge  
N/A

## 4 Select Hardware

Hardware  
N/A

Hardware  
N/A

Hardware  
N/A

## Product Features

- Finished top
- Interior cabinet depth 12.5"
- Panel doors with concealed finger pull
- 5/8" grommet(s) included for task light wire management

## Notes

- Unit has black back panel and is not designed for Open Plan use. Select OPB Option for Open Plan application

## Options

### Door

- D2: Door Lock - \$100 per door set
- D6: Delete Doors - n/c
- D9SC: Soft Close Door Hinges - \$20 per door
- WPD3061: Designer White - \$80 per door

### Grommets (Vertical Surface)

- Standard Location - \$50 ea.
- Black Plastic Vertical Surface: TM50-C (Bottom Center)
- Non-Standard Location - \$95 ea.
- Black Plastic Vertical Surface: TM50-NS

### Interior Cabinet Lighting

- LEDPK starter kit includes Infeed, 1 Puck Interior Light and the ability to daisy chain up to 6 total Puck Lights
- LED Puck Starter Kit - \$310
- PK: 1 LED Interior Light - \$130

### Task Lighting

- Overhead task light cord is located on the right facing side. If the opposite location is required please contact customer service.
- LT-LED24: 24" LED Task light - \$215
- LT-LED48: 48" LED Task light - \$270
- LT-LED60: 60" LED Task light - \$335
- LT-LED72: 72" LED Task light - \$360

### Open Plan \_ Finished Back

- OPB: "W" "G" Style - Modify Unit for Open Plan Application - \$295
- OPBM: "M" Style - Modify Unit for Open Plan Application - \$95

## NOT SO square office

Single Storage Overhead Consoles  
Silverluma Frame Doors / 6/4/2 Door

[Click here to view statement of line](#)

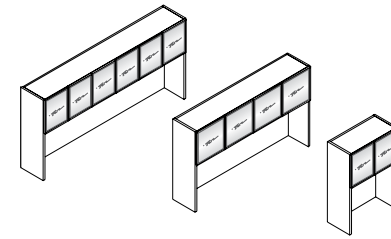

### 1 Select Model

w" x d" x h"

6 Door / 3 Section

93 x 14 x 42

315

NSS9342OH321W 5120

87 x 14 x 42

285

NSS8742OH321W 4992

4 Door / 2 Section

83 x 14 x 42

275

NSS8342OH321W 4928

76 x 14 x 42

255

NSS7642OH321W 4281

70 x 14 x 42

240

NSS7042OH321W 3980

64 x 14 x 42

225

NSS6442OH321W 3826

58 x 14 x 42

210

NSS5842OH321W 3723

47 x 14 x 42

190

NSS4742OH321W 3588

2 Door / 1 Section

35 x 14 x 42

120

NSS3542OH321W 2309

29 x 14 x 42

105

NSS2942OH321W 2173

Weight

	Standard Veneer Top Standard Veneer Chassis	Premium Veneer Top Premium Veneer Chassis	High Pressure Laminate Top Veneer Chassis	Thermally Fused Laminate Top Thermally Fused Laminate Chassis
			"G" Option N/A	NSS9342OH321M 3514
			"G" Option N/A	NSS8742OH321M 3348
			"G" Option N/A	NSS8342OH321M 2653
			"G" Option N/A	NSS7642OH321M 2564
			"G" Option N/A	NSS7042OH321M 2237
			"G" Option N/A	NSS6442OH321M 2156
			"G" Option N/A	NSS5842OH321M 2084
			"G" Option N/A	NSS4742OH321M 1927
			"G" Option N/A	NSS3542OH321M 1193
			"G" Option N/A	NSS2942OH321M 1140

### 2 Select Finish

[Click to view finishes](#)

[Click to view finishes](#)

[Click to view finishes](#)

### 3 Select Edge

Edge  
N/A

Edge  
N/A

Edge  
N/A

### 4 Select Hardware

Hardware  
N/A

Hardware  
N/A

Hardware  
N/A

### Product Features

- Finished top
- Interior cabinet depth 12.5"
- SilverLuma frame doors with frosted acrylic inserts
- 5/8" grommet(s) included for task light wire management

### Notes

- Unit has black back panel and is not designed for Open Plan use. Select OPB Option for Open Plan application

### Options

#### Door

- D2: Door Lock - \$100 per door set
- D6: Delete Doors - n/c
- D9SC: Soft Close Door Hinges - \$20 per door

#### Grommets (Vertical Surface)

- Standard Location - \$50 ea.
- Black Plastic Vertical Surface: TM50-C (Bottom Center)
- Non-Standard Location - \$95 ea.
- Black Plastic Vertical Surface: TM50-NS

#### Interior Cabinet Lighting

- LEDPK starter kit includes Infeed, 1 Puck Interior Light and the ability to daisy chain up to 6 total Puck Lights
- LED Puck Starter Kit - \$310
- PK: 1 LED Interior Light - \$130

#### Task Lighting

- Overhead task light cord is located on the right facing side. If the opposite location is required please contact customer service.
- LT-LED24: 24" LED Task light - \$215
- LT-LED48: 48" LED Task light - \$270
- LT-LED60: 60" LED Task light - \$335
- LT-LED72: 72" LED Task light - \$360

#### Open Plan \_ Finished Back

- OPB: "W" "G" Style - Modify Unit for Open Plan Application - \$295
- OPBM: "M" Style - Modify Unit for Open Plan Application - \$95

# NOT SO square office

Single Storage Overhead Consoles  
Open Storage Console

[Click here to view statement of line](#)

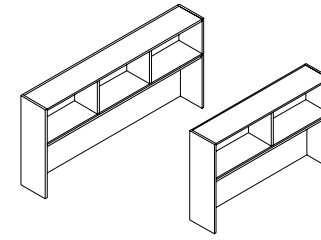

## 1 Select Model

w" x d" x h"	Weight
3 Section	
93 x 14 x 42	310
87 x 14 x 42	280
83 x 14 x 42	265
76 x 14 x 42	250
2 Section	
70 x 14 x 42	240
64 x 14 x 42	225
58 x 14 x 42	205

	Standard Veneer Top Standard Veneer Chassis	Premium Veneer Top Premium Veneer Chassis	High Pressure Laminate Top Veneer Chassis	Thermally Fused Laminate Top Thermally Fused Laminate Chassis
	NSS9342OH346W 4168	NSS9342OH346P 4586	"G" Option N/A	NSS9342OH346M 2645
	NSS8742OH346W 4126	NSS8742OH346P 4539	"G" Option N/A	NSS8742OH346M 2477
	NSS8342OH346W 4089	NSS8342OH346P 4499	"G" Option N/A	NSS8342OH346M 1934
	NSS7642OH346W 3524	NSS7642OH346P 3876	"G" Option N/A	NSS7642OH346M 1850
	NSS7042OH346W 3252	NSS7042OH346P 3577	"G" Option N/A	NSS7042OH346M 1661
	NSS6442OH346W 3173	NSS6442OH346P 3491	"G" Option N/A	NSS6442OH346M 1581
	NSS5842OH346W 3122	NSS5842OH346P 3435	"G" Option N/A	NSS5842OH346M 1502

## Product Features

- Finished top
- Interior cabinet depth 12.5"
- 5/8" grommet(s) included for task light wire management

## Notes

- 1 or 2 optional door available
- Sliding Doors Will Not Pass Each Other
- Unit has black back panel and is not designed for Open Plan use. Select OPB Option for Open Plan application

## Options

### Grommets (Vertical Surface)

- Standard Location - \$50 ea.
- Black Plastic Vertical Surface: TM50-C (Bottom Center)
- Non-Standard Location - \$95 ea.
- Black Plastic Vertical Surface: TM50-NS

### Interior Cabinet Lighting

- LEDPK starter kit includes Infeed, 1 Puck Interior Light and the ability to daisy chain up to 6 total Puck Lights
- LED Puck Starter Kit - \$310
- PK: 1 LED Interior Light - \$130

### Open Plan \_ Finished Back

- OPB: "W" "G" Style - Modify Unit for Open Plan Application - \$295
- OPBM: "M" Style - Modify Unit for Open Plan Application - \$95

### Sliding Door

- SLD17LD: Laminate Door - \$205 per door
- SLD17FD: SilverLuma / Frost Door ("W", "M" only) - \$365 per door
- SLD17WD: Wood Door - \$260 per door

### Task Lighting

- Overhead task light cord is located on the right facing side. If the opposite location is required please contact customer service.
- LT-LED24: 24" LED Task light - \$215
- LT-LED48: 48" LED Task light - \$270
- LT-LED60: 60" LED Task light - \$335
- LT-LED72: 72" LED Task light - \$360

## 2 Select Finish

[Click to view finishes](#)

[Click to view finishes](#)

[Click to view finishes](#)

## 3 Select Edge

Edge  
N/A

Edge  
N/A

Edge  
N/A

## 4 Select Hardware

Hardware  
N/A

Hardware  
N/A

Hardware  
N/A

# NOT SO square office

Double Height Overhead Consoles  
Panel Door

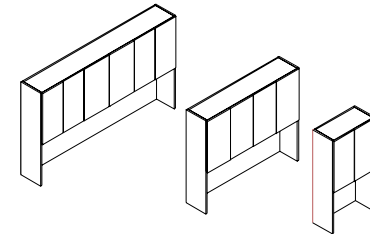

[Click here to view statement of line](#)

### 1 Select Model

w" x d" x h"

6 Door / 3 Section

93 x 14 x 54

Weight

300

87 x 14 x 54

290

83 x 14 x 54

280

4 Door / 2 Section

70 x 14 x 54

250

64 x 14 x 54

230

58 x 14 x 54

215

2 Door / 1 Section

35 x 14 x 54

160

29 x 14 x 54

150

	Standard Veneer Top Standard Veneer Chassis		Premium Veneer Top Premium Veneer Chassis		High Pressure Laminate Top Veneer Chassis	Thermally Fused Laminate Top Thermally Fused Laminate Chassis
	NSS9354OH325W	5184	NSS9354OH325P	5703	"G" Option N/A	NSS9354OH325M 3707
	NSS8754OH325W	5028	NSS8754OH325P	5532	"G" Option N/A	NSS8754OH325M 3563
	NSS8354OH325W	4955	NSS8354OH325P	5450	"G" Option N/A	NSS8354OH325M 2869
	NSS7054OH325W	4218	NSS7054OH325P	4642	"G" Option N/A	NSS7054OH325M 2591
	NSS6454OH325W	3980	NSS6454OH325P	4379	"G" Option N/A	NSS6454OH325M 2502
	NSS5854OH325W	3867	NSS5854OH325P	4255	"G" Option N/A	NSS5854OH325M 2161
	NSS3554OH325W	2374	NSS3554OH325P	2612	"G" Option N/A	NSS3554OH325M 1413
	NSS2954OH325W	2290	NSS2954OH325P	2519	"G" Option N/A	NSS2954OH325M 1368

### 2 Select Finish

[Click to view finishes](#)

[Click to view finishes](#)

[Click to view finishes](#)

### 3 Select Edge

Edge  
N/A

Edge  
N/A

Edge  
N/A

### 4 Select Hardware

Hardware  
N/A

Hardware  
N/A

Hardware  
N/A

### Product Features

- Finished top
- 1 Adjustable shelf behind each door section
- Interior cabinet depth 12.5"
- Interior shelf depth 12"
- Panel doors with concealed finger pull
- 5/8" grommet(s) included for task light wire management

### Notes

- Unit has black back panel and is not designed for Open Plan use. Select OPB Option for Open Plan application.

### Options

#### Door

- D2: Door Lock - \$100 per door set
- D6: Delete Doors - n/c
- D9SC: Soft Close Door Hinges - \$20 per door
- WPD3061: Designer White - \$80 per door

#### Grommets (Vertical Surface)

- Standard Location - \$50 ea.
- Black Plastic Vertical Surface: TM50-C (Bottom Center)
- Non-Standard Location - \$95 ea.
- Black Plastic Vertical Surface: TM50-NS

#### Interior Cabinet Lighting

- LEDPK starter kit includes Infeed, 1 Puck Interior Light and the ability to daisy chain up to 6 total Puck Lights
- LED Puck Starter Kit - \$310
- PK: 1 LED Interior Light - \$130

#### Task Lighting

- Overhead task light cord is located on the right facing side. If the opposite location is required please contact customer service.
- LT-LED24: 24" LED Task light - \$215
- LT-LED48: 48" LED Task light - \$270
- LT-LED60: 60" LED Task light - \$335
- LT-LED72: 72" LED Task light - \$360

#### Open Plan \_ Finished Back

- OPB: "W" "G" Style - Modify Unit for Open Plan Application - \$295
- OPBM: "M" Style - Modify Unit for Open Plan Application - \$95

#### Shelf

- S714F: Heavy Duty Lumber 1" Shelves - \$80 per shelf ("M" Styles - n/a)



# NOT SO square office

Double Height Overhead Consoles  
Silverluma Frame 6/4/2 Doors

[Click here to view statement of line](#)

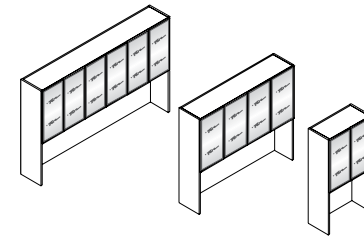

## 1 Select Model

w" x d" x h"	Weight
6 Door / 3 Section	
93 x 14 x 54	300
87 x 14 x 54	290
4 Door / 2 Section	
70 x 14 x 54	250
64 x 14 x 54	230
58 x 14 x 54	215
2 Door / 1 Section	
35 x 14 x 54	160
29 x 14 x 54	150

	Standard Veneer Top Standard Veneer Chassis		Premium Veneer Top Premium Veneer Chassis		High Pressure Laminate Top Veneer Chassis	Thermally Fused Laminate Top Thermally Fused Laminate Chassis	
	NSS9354OH321W	6359	NSS9354OH321P	6995	"G" Option N/A	NSS9354OH321M	4494
	NSS8754OH321W	6100	NSS8754OH321P	6709	"G" Option N/A	NSS8754OH321M	4349
	NSS7054OH321W	5298	NSS7054OH321P	5828	"G" Option N/A	NSS7054OH321M	3116
	NSS6454OH321W	4691	NSS6454OH321P	5160	"G" Option N/A	NSS6454OH321M	3026
	NSS5854OH321W	4475	NSS5854OH321P	4922	"G" Option N/A	NSS5854OH321M	2686
	NSS3554OH321W	2837	NSS3554OH321P	3121	"G" Option N/A	NSS3554OH321M	1674
	NSS2954OH321W	2650	NSS2954OH321P	2915	"G" Option N/A	NSS2954OH321M	1630

## 2 Select Finish

[Click to view finishes](#)

[Click to view finishes](#)

[Click to view finishes](#)

## 3 Select Edge

Edge  
N/A

Edge  
N/A

Edge  
N/A

## 4 Select Hardware

Hardware  
N/A

Hardware  
N/A

Hardware  
N/A

## Product Features

- Finished top
- 1 Adjustable shelf per section standard
- Interior cabinet depth 12.5"
- Interior shelf depth 12"
- Silverluma doors w/ frosted acrylic inserts
- 5/8" grommet(s) included for task light wire management

## Notes

- Unit has black back panel and is not designed for Open Plan use. Select OPB Option for Open Plan application.

## Options

### Door

- D2: Door Lock - \$100 per door set
- D6: Delete Doors - n/c
- D9SC: Soft Close Door Hinges - \$20 per door

### Grommets (Vertical Surface)

- Standard Location - \$50 ea.
- Black Plastic Vertical Surface: TM50-C (Bottom Center)
- Non-Standard Location - \$95 ea.
- Black Plastic Vertical Surface: TM50-NS

### Interior Cabinet Lighting

- LEDPK starter kit includes Infeed, 1 Puck Interior Light and the ability to daisy chain up to 6 total Puck Lights
- LED Puck Starter Kit - \$310
- PK: 1 LED Interior Light - \$130

### Task Lighting

Overhead task light cord is located on the right facing side. If the opposite location is required please contact customer service.

- LT-LED24: 24" LED Task light - \$215
- LT-LED48: 48" LED Task light - \$270
- LT-LED60: 60" LED Task light - \$335
- LT-LED72: 72" LED Task light - \$360

### Open Plan \_ Finished Back

- OPB: "W" "G" Style - Modify Unit for Open Plan Application - \$295
- OPBM: "M" Style - Modify Unit for Open Plan Application - \$95

### Shelf

- GS14F: Replace Standard Shelves with Glass Shelves - \$90 per shelf
- S714F: Heavy Duty Lumber 1" Shelves - \$80 per shelf ("M" Styles - n/a)

Overhead tackboards  
Full width tackboards

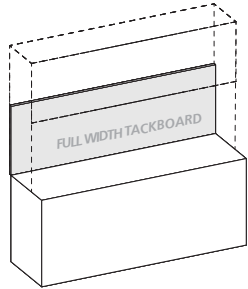

Product Width	Panel Dimension	SKU	COM	1	2	3	4	5	6	7	8	9	10	11/L1	12	13/L2
93"	91 x .75 x 21	FTOC9121	379	480	531	582	633	684	735	786	837	888	939	990	1041	1143
87"	85 x .75 x 21	FTOC8521	358	449	497	545	593	641	689	737	785	833	881	929	977	1073
83"	81 x .75 x 21	FTOC8121	336	428	474	520	566	612	658	704	750	796	842	888	934	1026
76"	74 x .75 x 21	FTOC7421	309	392	435	478	521	564	607	650	693	736	779	822	865	951
70"	68 x .75 x 21	FTOC6821	282	361	401	441	481	521	561	601	641	681	721	761	801	881
64"	62 x .75 x 21	FTOC6221	256	330	366	402	438	474	510	546	582	618	654	690	726	798
58"	56 x .75 x 21	FTOC5621	234	299	331	363	395	427	459	491	523	555	587	619	651	715
47"	45 x .75 x 21	FTOC4521	187	242	269	296	323	350	377	404	431	458	485	512	539	593
35"	33 x .75 x 21	FTOC3321	141	180	200	220	240	260	280	300	320	340	360	380	400	440
29"	27 x .75 x 21	FTOC2721	112	149	166	183	200	217	234	251	268	285	302	319	336	370

Standard Features

- Constructed of .5" thick fiberboard
- Hung with Z-Strip mounting system

Overhead tackboards  
Half width tackboards

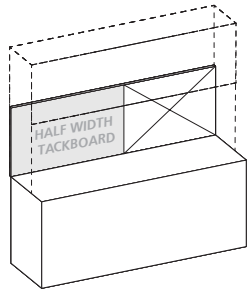

Product Width	Panel Dimension	SKU	COM	1	2	3	4	5	6	7	8	9	10	11/L1	12	13/L2
93 Half Width	46.5 x .75 x 21	FTOC4621	189	240	266	292	318	344	370	396	422	448	474	500	526	578
87 Half Width	43.5 x .75 x 21	FTOC4321	179	225	249	273	297	321	345	369	393	417	441	465	489	537
83 Half Width	41.5 x .75 x 21	FTOC4121	168	214	237	260	283	306	329	352	375	398	421	444	467	513
76 Half Width	38 x .75 x 21	FTOC3821	155	196	217	238	259	280	301	322	343	364	385	406	427	469
70 Half Width	35 x .75 x 21	FTOC3521	141	180	200	220	240	260	280	300	320	340	360	380	400	440
64 Half Width	32 x .75 x 21	FTOC3221	128	165	183	201	219	237	255	273	291	309	327	345	363	399

Standard Features

- Constructed of .5" thick fiberboard
- Fabric is precisely aligned and fitted to the tackboard
- Adhered to the rigid hardboard with glue
- Hung with Z-Strip mounting system

Notes

- Half width tackboards can be specified and combined with Marker Board, and Glass Board options. See "Half Width" items under product width.
- Must specify right or left facing tackboard

Overhead dry marker board  
Full width dry marker boards

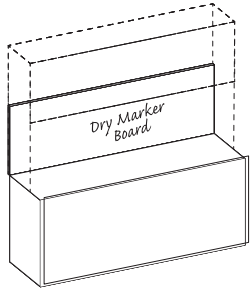

Product Width	Panel Dimension	SKU	List
93"	91 x .5 x 21	DMOC9121	1136
87"	85 x .5 x 21	DMOC8521	1061
83"	81 x .5 x 21	DMOC8121	1011
76"	74 x .5 x 21	DMOC7421	924
70"	68 x .5 x 21	DMOC6821	849
64"	62 x .5 x 21	DMOC6221	774
58"	56 x .5 x 21	DMOC5621	699
47"	45 x .5 x 21	DMOC4521	587
35"	33 x .5 x 21	DMOC3321	437
29"	27 x .5 x 21	DMOC2721	337

Overhead dry marker board  
Half width dry marker boards

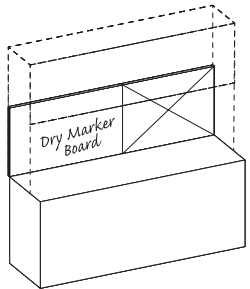

Standard Features

- Dry marker panel has edge trim molding
- Standard magnetic surface
- Hung with Z-Strip mounting system

Product Width	Panel Dimension	SKU	List
93 Half Width	45.5 x .5 x 21	DMOC4521	587
87 Half Width	42.5 x .5 x 21	DMOC4221	538
83 Half Width	40.5 x .5 x 21	DMOC4021	521
76 Half Width	37 x .5 x 21	DMOC3721	466
70 Half Width	34 x .5 x 21	DMOC3421	437
64 Half Width	31 x .5 x 21	DMOC3121	388

Standard Features

- Dry marker panel has edge trim molding
- Standard magnetic surface
- Hung with Z-Strip mounting system

Notes

- Half width dry marker boards can be specified and combined with a Tackboard, Veneer Panel, or Glass Board. See "Half Width" items under product width.
- Specify right or left facing dry marker board

Overhead glassboard  
Full width glassboards

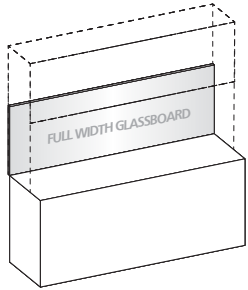

Product Width	Panel Dimension	SKU	List
93"	91 x .5 x 21	GBOC9121	2378
87"	85 x .5 x 21	GBOC8521	2233
83"	81 x .5 x 21	GBOC8121	2134
76"	74 x .5 x 21	GBOC7421	1966
70"	68 x .5 x 21	GBOC6821	1819
64"	62 x .5 x 21	GBOC6221	1673
58"	56 x .5 x 21	GBOC5621	1592
47"	45 x .5 x 21	GBOC4521	1312
35"	33 x .5 x 21	GBOC3321	972
29"	27 x .5 x 21	GBOC2721	825

Overhead glassboard  
Half width glassboards

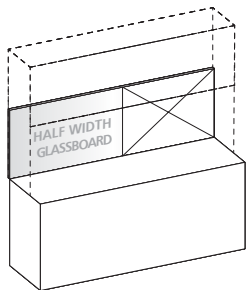

Standard Features

- 4 mm tempered glass
- Use glass cleaner or alcohol to clean
- Standard dry erase markers may be used

Product Width	Panel Dimension	SKU	List
93 Half Width	45.5 x .5 x 21	GBOC4521	1312
87 Half Width	42.5 x .5 x 21	GBOC4221	1176
83 Half Width	40.5 x .5 x 21	GBOC4021	1127
76 Half Width	37 x .5 x 21	GBOC3721	1009
70 Half Width	34 x .5 x 21	GBOC3421	984
64 Half Width	31 x .5 x 21	GBOC3121	898

Standard Features

- 4 mm tempered glass
- Hung with Z-Strip mounting system

Notes

- Earth magnets are required to hold items securely in place
- Use glass cleaner or alcohol to clean
- Hung with Z-Strip mounting system
- Standard dry erase markers may be used

Notes

- Half width glassboards can be specified and combined with a Tackboard, Veneer panel, Marker Board. See "Half Width" items under product width.
- Specify right or left facing glassboard
- Use glass cleaner or alcohol to clean
- Standard dry erase markers may be used
- Earth magnets are required to hold items securely in place

# NOT SO square office

Single Height Wall Hung Overheads  
Panel Doors

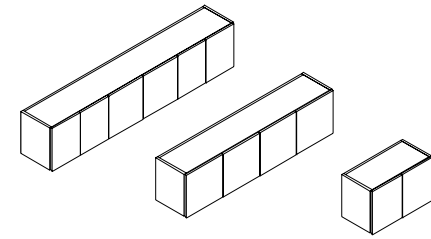

[Click here to view statement of line](#)

### 1 Select Model

w" x d" x h"  
6 Door / 3 Section  
93 x 14 x 18  
87 x 14 x 18  
4 Door / 2 Section  
83 x 14 x 18  
76 x 14 x 18  
70 x 14 x 18  
64 x 14 x 18  
58 x 14 x 18  
47 x 14 x 18  
2 Door / 1 Section  
35 x 14 x 18  
29 x 14 x 18

Weight

		Standard Veneer Top Standard Veneer Chassis		Premium Veneer Top Premium Veneer Chassis		High Pressure Laminate Top Veneer Chassis	Thermally Fused Laminate Top Thermally Fused Laminate Chassis
240	NSS9318WH330W	4262	NSS9318WH330P	4688	"G" Option N/A	NSS9318WH330M	3001
225	NSS8718WH330W	4097	NSS8718WH330P	4506	"G" Option N/A	NSS8718WH330M	2837
210	NSS8318WH330W	4003	NSS8318WH330P	4403	"G" Option N/A	NSS8318WH330M	2234
195	NSS7618WH330W	3932	NSS7618WH330P	4325	"G" Option N/A	NSS7618WH330M	2071
180	NSS7018WH330W	3286	NSS7018WH330P	3616	"G" Option N/A	NSS7018WH330M	1916
160	NSS6418WH330W	3236	NSS6418WH330P	3561	"G" Option N/A	NSS6418WH330M	1856
135	NSS5818WH330W	3189	NSS5818WH330P	3508	"G" Option N/A	NSS5818WH330M	1798
125	NSS4718WH330W	2437	NSS4718WH330P	2680	"G" Option N/A	NSS4718WH330M	1713
75	NSS3518WH330W	1829	NSS3518WH330P	2012	"G" Option N/A	NSS3518WH330M	1219
65	NSS2918WH330W	1798	NSS2918WH330P	1979	"G" Option N/A	NSS2918WH330M	1169

### 2 Select Finish

[Click to view finishes](#)

[Click to view finishes](#)

[Click to view finishes](#)

### 3 Select Edge

Edge  
N/A

Edge  
N/A

Edge  
N/A

### 4 Select Hardware

Hardware  
N/A

Hardware  
N/A

Hardware  
N/A

### Product Features

- Finished top
- Interior cabinet depth 12"
- Mounting wall rail included
- Panel doors with concealed finger pull

### Notes

- The DARRAN wall mounted cabinet(or shelf) must be hung on a weight-bearing wall. The suitability of the wall supporting the wall mounted cabinet, and the installation and maintenance of the wall-mounted cabinet, is the sole responsibility of the customer. Failure to correctly install and/or exceed the loaded weight capacity of this product may cause it to fall, resulting in damage to the product, adjacent property and/or bodily injury.

### Options

#### Door

- D2: Door Lock - \$100 per door set
- D6: Delete Doors - n/c
- D9SC: Soft Close Door Hinges - \$20 per door
- WPD3061: Designer White - \$80 per door

#### Interior Cabinet Lighting

- LEDPK starter kit includes Infeed, 1 Puck Interior Light and the ability to daisy chain up to 6 total Puck Lights
- LED Puck Starter Kit - \$310
- PK: 1 LED Interior Light - \$130

#### Task Lighting

- Overhead task light cord is located on the right facing side. If the opposite location is required please contact customer service.
- LT-LED24: 24" LED Task light - \$215
- LT-LED48: 48" LED Task light - \$270
- LT-LED60: 60" LED Task light - \$335
- LT-LED72: 72" LED Task light - \$360

# NOT SO square office

Single Height Wall Hung Overheads  
Silverluma Frame / Doors

[Click here to view statement of line](#)

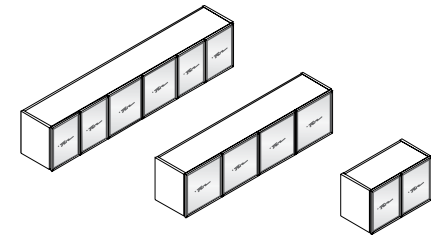

## 1 Select Model

w" x d" x h"	Weight
6 Door / 3 Section	
93 x 15 x 18	240
87 x 15 x 18	225
4 Door / 2 Section	
83 x 15 x 18	210
76 x 15 x 18	195
70 x 15 x 18	180
64 x 15 x 18	160
58 x 15 x 18	135
47 x 15 x 18	125
2 Door / 1 Section	
35 x 15 x 18	75
29 x 15 x 18	65

	Standard Veneer Top Standard Veneer Chassis	Premium Veneer Top Premium Veneer Chassis	High Pressure Laminate Top Veneer Chassis	Thermally Fused Laminate Top Thermally Fused Laminate Chassis
			"G" Option N/A	
			"G" Option N/A	
			"G" Option N/A	
			"G" Option N/A	
			"G" Option N/A	
			"G" Option N/A	
			"G" Option N/A	
			"G" Option N/A	
			"G" Option N/A	
			"G" Option N/A	

## 2 Select Finish

<a href="#">Click to view finishes</a>	<a href="#">Click to view finishes</a>	<a href="#">Click to view finishes</a>
--	--	--

## 3 Select Edge

Edge N/A	Edge N/A	Edge N/A
-------------	-------------	-------------

## 4 Select Hardware

Hardware N/A	Hardware N/A	Hardware N/A
-----------------	-----------------	-----------------

## Product Features

- Finished top
- Interior cabinet depth 12"
- Mounting wall rail included
- Silverluma doors w/ frosted acrylic inserts

## Notes

- The DARRAN wall mounted cabinet(or shelf) must be hung on a weight-bearing wall. The suitability of the wall supporting the wall mounted cabinet, and the installation and maintenance of the wall-mounted cabinet, is the sole responsibility of the customer. Failure to correctly install and/or exceed the loaded weight capacity of this product may cause it to fall, resulting in damage to the product, adjacent property and/or bodily injury.

## Options

- Door**
- D2: Door Lock - \$100 per door set
  - D6: Delete Doors - n/c
  - D9SC: Soft Close Door Hinges - \$20 per door

### Interior Cabinet Lighting

- LEDPK starter kit includes Infeed, 1 Puck Interior Light and the ability to daisy chain up to 6 total Puck Lights
- LED Puck Starter Kit - \$310
  - PK: 1 LED Interior Light - \$130

### Task Lighting

- Overhead task light cord is located on the right facing side. If the opposite location is required please contact customer service.
- LT-LED24: 24" LED Task light - \$215
  - LT-LED48: 48" LED Task light - \$270
  - LT-LED60: 60" LED Task light - \$335
  - LT-LED72: 72" LED Task light - \$360

# NOT SO square office

Single Height Wall Hung Overheads  
Open Storage Cabinet

[Click here to view statement of line](#)

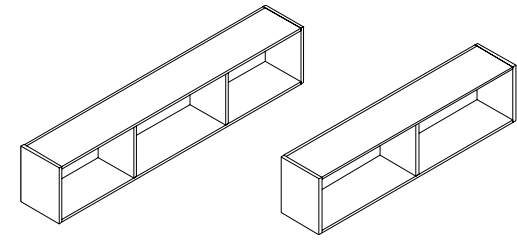

## 1 Select Model

w" x d" x h"	Weight
3 Section	
93 x 14 x 18	225
87 x 14 x 18	210
83 x 14 x 18	200
76 x 14 x 18	185
2 Section	
70 x 14 x 18	170
64 x 14 x 18	150
58 x 14 x 18	125
47 x 14 x 18	115
1 Section	
35 x 14 x 18	60
29 x 14 x 18	50

	Standard Veneer Top Standard Veneer Chassis	Premium Veneer Top Premium Veneer Chassis	High Pressure Laminate Top Veneer Chassis	Thermally Fused Laminate Top Thermally Fused Laminate Chassis
			"G" Option N/A	NSS9318WH332M 2546
	NSS9318WH332W 3925	NSS9318WH332P 4318	"G" Option N/A	NSS8718WH332M 2383
	NSS8718WH332W 3889	NSS8718WH332P 4278	"G" Option N/A	NSS8318WH332M 1787
	NSS8318WH332W 3852	NSS8318WH332P 4238	"G" Option N/A	NSS7618WH332M 1695
	NSS7618WH332W 3810	NSS7618WH332P 4190	"G" Option N/A	
			"G" Option N/A	NSS7018WH332M 1607
	NSS7018WH332W 3116	NSS7018WH332P 3428	"G" Option N/A	NSS6418WH332M 1555
	NSS6418WH332W 3067	NSS6418WH332P 3374	"G" Option N/A	NSS5818WH332M 1494
	NSS5818WH332W 3024	NSS5818WH332P 3327	"G" Option N/A	NSS4718WH332M 1409
	NSS4718WH332W 2258	NSS4718WH332P 2485	"G" Option N/A	
			"G" Option N/A	NSS3518WH332M 1051
	NSS3518WH332W 1697	NSS3518WH332P 1868	"G" Option N/A	NSS2918WH332M 1002
	NSS2918WH332W 1679	NSS2918WH332P 1846		

## 2 Select Finish

[Click to view finishes](#)

[Click to view finishes](#)

[Click to view finishes](#)

## 3 Select Edge

Edge  
N/A

Edge  
N/A

Edge  
N/A

## 4 Select Hardware

Hardware  
N/A

Hardware  
N/A

Hardware  
N/A

## Product Features

- Finished top
- Interior cabinet depth 12"
- Mounting wall rail included

## Notes

- The DARRAN wall mounted cabinet(or shelf) must be hung on a weight-bearing wall. The suitability of the wall supporting the wall mounted cabinet, and the installation and maintenance of the wall-mounted cabinet, is the sole responsibility of the customer. Failure to correctly install and/or exceed the loaded weight capacity of this product may cause it to fall, resulting in damage to the product, adjacent property and/or bodily injury.
- Sliding doors will not pass each other

## Options

### Sliding Door

- SLD17LD: Laminate Door - \$205 per door
- SLD17FD: SilverLuma / Frost Door ("W", "M" only) - \$365 per door
- SLD17WD: Wood Door - \$260 per door

### Interior Cabinet Lighting

- LEDPK starter kit includes Infeed, 1 Puck Interior Light and the ability to daisy chain up to 6 total Puck Lights
- LED Puck Starter Kit - \$310
- PK: 1 LED Interior Light - \$130

### Task Lighting

- Overhead task light cord is located on the right facing side. If the opposite location is required please contact customer service.
- LT-LED24: 24" LED Task light - \$215
- LT-LED48: 48" LED Task light - \$270
- LT-LED60: 60" LED Task light - \$335
- LT-LED72: 72" LED Task light - \$360

# NOT SO square office

Double Height Wall Hung Overheads  
Panel Doors

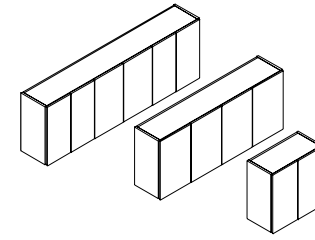

[Click here to view statement of line](#)

## 1 Select Model

w" x d" x h"

6 Door / 3 Section

93 x 14 x 29 265

87 x 14 x 29 250

4 Door / 2 Section

83 x 14 x 29 235

70 x 14 x 29 220

64 x 14 x 29 200

58 x 14 x 29 180

2 Door / 1 Section

35 x 14 x 29 85

29 x 14 x 29 75

Weight

	Standard Veneer Top Standard Veneer Chassis	Premium Veneer Top Premium Veneer Chassis	High Pressure Laminate Top Veneer Chassis	Thermally Fused Laminate Top Thermally Fused Laminate Chassis
	NSS9329WH330W 4955	NSS9329WH330P 5450	"G" Option N/A	NSS9329WH330M 3687
	NSS8729WH330W 4877	NSS8729WH330P 5364	"G" Option N/A	NSS8729WH330M 3524
	NSS8329WH330W 4805	NSS8329WH330P 5285	"G" Option N/A	NSS8329WH330M 2607
	NSS7029WH330W 4053	NSS7029WH330P 4458	"G" Option N/A	NSS7029WH330M 2472
	NSS6429WH330W 4018	NSS6429WH330P 4420	"G" Option N/A	NSS6429WH330M 2418
	NSS5829WH330W 3938	NSS5829WH330P 4333	"G" Option N/A	NSS5829WH330M 2320
	NSS3529WH330W 2128	NSS3529WH330P 2341	"G" Option N/A	NSS3529WH330M 1664
	NSS2929WH330W 2078	NSS2929WH330P 2287	"G" Option N/A	NSS2929WH330M 1612

## 2 Select Finish

[Click to view finishes](#)

[Click to view finishes](#)

[Click to view finishes](#)

## 3 Select Edge

Edge  
N/A

Edge  
N/A

Edge  
N/A

## 4 Select Hardware

Hardware  
N/A

Hardware  
N/A

Hardware  
N/A

## Product Features

- 1 Adjustable shelf per section standard
- Black painted top
- Interior cabinet depth 12"
- Interior shelf depth 11.5"
- Mounting rails included
- Panel doors with concealed finger pull

## Notes

- The DARRAN wall mounted cabinet(or shelf) must be hung on a weight-bearing wall. The suitability of the wall supporting the wall mounted cabinet, and the installation and maintenance of the wall-mounted cabinet, is the sole responsibility of the customer. Failure to correctly install and/or exceed the loaded weight capacity of this product may cause it to fall, resulting in damage to the product, adjacent property and/or bodily injury.

## Options

### Door

- D2: Door Lock - \$100 per door set
- D6: Delete Doors - n/c
- D9SC: Soft Close Door Hinges - \$20 per door
- WPD3061: Designer White - \$80 per door

### Interior Cabinet Lighting

- LEDPK starter kit includes Infeed, 1 Puck Interior Light and the ability to daisy chain up to 6 total Puck Lights
- LED Puck Starter Kit - \$310
- PK: 1 LED Interior Light - \$130

### Task Lighting

- Overhead task light cord is located on the right facing side. If the opposite location is required please contact customer service.
- LT-LED24: 24" LED Task light - \$215
- LT-LED48: 48" LED Task light - \$270
- LT-LED60: 60" LED Task light - \$335
- LT-LED72: 72" LED Task light - \$360

### Shelf

- S714F: Heavy Duty Lumber 1" Shelves - \$80 per shelf ("M" Styles - n/a)



# NOT SO square office

Double Height Wall Hung Overheads  
Silverluma Frame / Doors

[Click here to view statement of line](#)

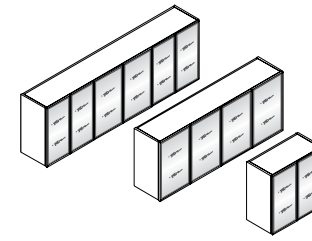

## 1 Select Model

w" x d" x h"	Weight
6 Door / 3 Section	
93 x 14 x 29	265
87 x 14 x 29	250
4 Door / 2 Section	
70 x 14 x 29	220
64 x 14 x 29	200
58 x 14 x 29	180
2 Door / 1 Section	
35 x 14 x 29	85
29 x 14 x 29	75

	Standard Veneer Top Standard Veneer Chassis		Premium Veneer Top Premium Veneer Chassis		High Pressure Laminate Top Veneer Chassis	Thermally Fused Laminate Top Thermally Fused Laminate Chassis	
					"G" Option N/A		
					"G" Option N/A		
					"G" Option N/A		
					"G" Option N/A		
					"G" Option N/A		
					"G" Option N/A		
					"G" Option N/A		

## 2 Select Finish

<a href="#">Click to view finishes</a>	<a href="#">Click to view finishes</a>	<a href="#">Click to view finishes</a>	<a href="#">Click to view finishes</a>
--	--	--	--

## 3 Select Edge

Edge N/A	Edge N/A	Edge N/A
-------------	-------------	-------------

## 4 Select Hardware

Hardware N/A	Hardware N/A	Hardware N/A
-----------------	-----------------	-----------------

## Product Features

- Black painted top
- Interior cabinet depth 12"
- Interior shelf depth 11.5"
- Mounting rails included
- Silverluma doors w/ frosted acrylic inserts

## Notes

- 1 Adjustable Shelf per section
- The DARRAN wall mounted cabinet(or shelf) must be hung on a weight-bearing wall. The suitability of the wall supporting the wall mounted cabinet, and the installation and maintenance of the wall-mounted cabinet, is the sole responsibility of the customer. Failure to correctly install and/or exceed the loaded weight capacity of this product may cause it to fall, resulting in damage to the product, adjacent property and/or bodily injury.

## Options

- Door**
- D2: Door Lock - \$100 per door set
  - D6: Delete Doors - n/c
  - D9SC: Soft Close Door Hinges - \$20 per door

- Interior Cabinet Lighting**
- LEDPK starter kit includes Infeed, 1 Puck Interior Light and the ability to daisy chain up to 6 total Puck Lights
- LED Puck Starter Kit - \$310
  - PK: 1 LED Interior Light - \$130

- Task Lighting**
- Overhead task light cord is located on the right facing side. If the opposite location is required please contact customer service.
- LT-LED24: 24" LED Task light - \$215
  - LT-LED48: 48" LED Task light - \$270
  - LT-LED60: 60" LED Task light - \$335
  - LT-LED72: 72" LED Task light - \$360

- Shelf**
- GS14F: Replace Standard Shelves with Glass Shelves - \$90 per shelf
  - S714F: Heavy Duty Lumber 1" Shelves - \$80 per shelf ("M" Styles - n/a)

# NOT SO square office

Double Height Wall Hung Overheads  
Open Storage Cabinet

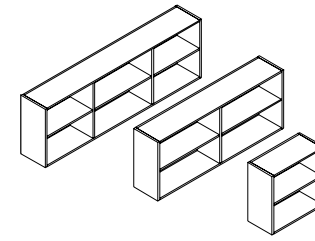

[Click here to view statement of line](#)

## 1 Select Model

w" x d" x h"	Weight
3 Section	
93 x 14 x 29	215
87 x 14 x 29	200
83 x 14 x 29	190
2 Section	
70 x 14 x 29	180
64 x 14 x 29	170
58 x 14 x 29	150
1 Section	
35 x 14 x 29	70
29 x 14 x 29	60

	Standard Veneer Top Standard Veneer Chassis	Premium Veneer Top Premium Veneer Chassis	High Pressure Laminate Top Veneer Chassis	Thermally Fused Laminate Top Thermally Fused Laminate Chassis
			"G" Option N/A	NSS9329WH332M 2975
	NSS9329WH332W 4481	NSS9329WH332P 4931	"G" Option N/A	NSS8729WH332M 2810
	NSS8729WH332W 4398	NSS8729WH332P 4838	"G" Option N/A	NSS8329WH332M 2137
	NSS8329WH332W 4317	NSS8329WH332P 4750		
			"G" Option N/A	NSS7029WH332M 1986
	NSS7029WH332W 3688	NSS7029WH332P 4058	"G" Option N/A	NSS6429WH332M 1947
	NSS6429WH332W 3617	NSS6429WH332P 3978	"G" Option N/A	NSS5829WH332M 1851
	NSS5829WH332W 3532	NSS5829WH332P 3885		
			"G" Option N/A	NSS3529WH332M 1426
	NSS3529WH332W 1972	NSS3529WH332P 2169	"G" Option N/A	NSS2929WH332M 1377
	NSS2929WH332W 1927	NSS2929WH332P 2121		

## Product Features

- 1 Adjustable shelf per section
- Black painted top
- Interior cabinet depth 12"
- Interior shelf depth 11.5"
- Mounting rails included

## Notes

- 1 or 2 Optional Doors Available
- Sliding doors will not pass each other
- The DARRAN wall mounted cabinet(or shelf) must be hung on a weight-bearing wall. The suitability of the wall supporting the wall mounted cabinet, and the installation and maintenance of the wall-mounted cabinet, is the sole responsibility of the customer. Failure to correctly install and/or exceed the loaded weight capacity of this product may cause it to fall, resulting in damage to the product, adjacent property and/or bodily injury.

## Options

### Sliding Door

- SLD29LD: Laminate Door - \$260 per door
- SLD29FD: SilverLuma / Frost Door ("W", "M" only) - \$415 per door
- SLD29WD: Wood Door - \$310 per door

### Task Lighting

Overhead task light cord is located on the right facing side. If the opposite location is required please contact customer service.

- LT-LED24: 24" LED Task light - \$215
- LT-LED48: 48" LED Task light - \$270
- LT-LED60: 60" LED Task light - \$335
- LT-LED72: 72" LED Task light - \$360

### Shelf

- GS14F: Replace Standard Shelves with Glass Shelves - \$90 per shelf
- S714F: Heavy Duty Lumber 1" Shelves - \$80 per shelf ("M" Styles - n/a)

## 2 Select Finish

[Click to view finishes](#)

[Click to view finishes](#)

[Click to view finishes](#)

## 3 Select Edge

Edge  
N/A

Edge  
N/A

Edge  
N/A

## 4 Select Hardware

Hardware  
N/A

Hardware  
N/A

Hardware  
N/A

Wall hung tackboards  
Full width tackboards

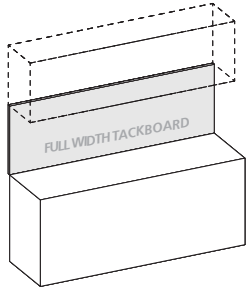

Product Width	Panel Dimension	SKU	COM	1	2	3	4	5	6	7	8	9	10	11/L1	12	13/L2
93	93 x .75 x 24	FTWH9324	464	576	627	678	729	780	831	882	933	984	1035	1086	1137	1239
87	87 x .75 x 24	FTWH8724	448	539	587	635	683	731	779	827	875	923	971	1019	1067	1163
83	83 x .75 x 24	FTWH8324	422	514	560	606	652	698	744	790	836	882	928	974	1020	1112
76	76 x .75 x 24	FTWH7624	387	471	514	557	600	643	686	729	772	815	858	901	944	1030
70	70 x .75 x 24	FTWH7024	355	434	474	514	554	594	634	674	714	754	794	834	874	954
64	64 x .75 x 24	FTWH6424	322	396	432	468	504	540	576	612	648	684	720	756	792	864
58	58 x .75 x 24	FTWH5824	294	359	391	423	455	487	519	551	583	615	647	679	711	775
47	47 x .75 x 24	FTWH4724	237	291	318	345	372	399	426	453	480	507	534	561	588	642
35	35 x .75 x 24	FTWH3524	185	217	237	257	277	297	317	337	357	377	397	417	437	477
29	29 x .75 x 24	FTWH2924	142	179	196	213	230	247	264	281	298	315	332	349	366	400

Standard Features

- Constructed of .5" thick fiberboard
- Fabric is precisely aligned and fitted to the tackboard
- Hung with Z-Strip mounting system

- Adhered to the rigid hardboard with glue

Wall hung tackboards  
Half width tackboards

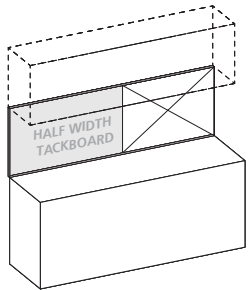

Product Width	Panel Dimension	SKU	COM	1	2	3	4	5	6	7	8	9	10	11/L1	12	13/L2
93 Half Width	46.5 x .75 x 24	FTWH4624	233	288	313	338	363	388	413	438	463	488	513	538	563	613
87 Half Width	43.5 x .75 x 24	FTWH4324	225	270	294	318	342	366	390	414	438	462	486	510	534	582
83 Half Width	41.5 x .75 x 24	FTWH4124	211	257	280	303	326	349	372	395	418	441	464	487	510	556
76 Half Width	38 x .75 x 24	FTWH3824	193	235	256	277	298	319	340	361	382	403	424	445	466	508
70 Half Width	35 x .75 x 24	FTWH3524	185	217	237	257	277	297	317	337	357	377	397	417	437	477
64 Half Width	32 x .75 x 24	FTWH3224	161	198	216	234	252	270	288	306	324	342	360	378	396	432

Standard Features

- Constructed of .5" thick fiberboard
- Fabric is precisely aligned and fitted to the tackboard
- Adhered to the rigid hardboard with glue
- Hung with Z-Strip mounting system

Notes

- Half width tackboards can be specified and combined with a Veneer Panel, Marker Board, or Glass Board See "Half Width" items under product width.
- Specify right or left facing tackboard

Overhead dry marker board  
Full width dry marker boards

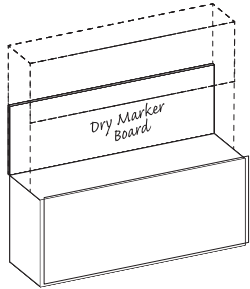

Product Width	Panel Dimension	SKU	List
93"	91 x .5 x 21	DMOC9121	1136
87"	85 x .5 x 21	DMOC8521	1061
83"	81 x .5 x 21	DMOC8121	1011
76"	74 x .5 x 21	DMOC7421	924
70"	68 x .5 x 21	DMOC6821	849
64"	62 x .5 x 21	DMOC6221	774
58"	56 x .5 x 21	DMOC5621	699
47"	45 x .5 x 21	DMOC4521	587
35"	33 x .5 x 21	DMOC3321	437
29"	27 x .5 x 21	DMOC2721	337

Overhead dry marker board  
Half width dry marker boards

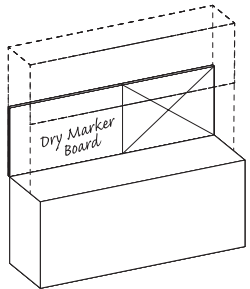

Standard Features

- Dry marker panel has edge trim molding
- Standard magnetic surface
- Hung with Z-Strip mounting system

Product Width	Panel Dimension	SKU	List
93 Half Width	45.5 x .5 x 21	DMOC4521	587
87 Half Width	42.5 x .5 x 21	DMOC4221	538
83 Half Width	40.5 x .5 x 21	DMOC4021	521
76 Half Width	37 x .5 x 21	DMOC3721	466
70 Half Width	34 x .5 x 21	DMOC3421	437
64 Half Width	31 x .5 x 21	DMOC3121	388

Standard Features

- Dry marker panel has edge trim molding
- Standard magnetic surface
- Hung with Z-Strip mounting system

Notes

- Half width dry marker boards can be specified and combined with a Tackboard, Veneer Panel, or Glass Board. See "Half Width" items under product width.
- Specify right or left facing dry marker board

Overhead glassboard  
Full width glassboards

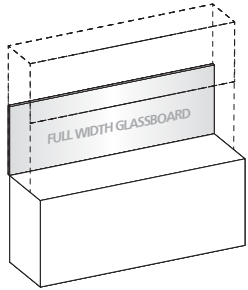

Product Width	Panel Dimension	SKU	List
93"	91 x .5 x 21	GBOC9121	2378
87"	85 x .5 x 21	GBOC8521	2233
83"	81 x .5 x 21	GBOC8121	2134
76"	74 x .5 x 21	GBOC7421	1966
70"	68 x .5 x 21	GBOC6821	1819
64"	62 x .5 x 21	GBOC6221	1673
58"	56 x .5 x 21	GBOC5621	1592
47"	45 x .5 x 21	GBOC4521	1312
35"	33 x .5 x 21	GBOC3321	972
29"	27 x .5 x 21	GBOC2721	825

Overhead glassboard  
Half width glassboards

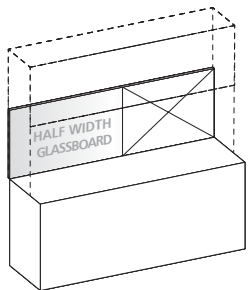

Standard Features

- 4 mm tempered glass
- Use glass cleaner or alcohol to clean
- Standard dry erase markers may be used

Product Width	Panel Dimension	SKU	List
93 Half Width	45.5 x .5 x 21	GBOC4521	1312
87 Half Width	42.5 x .5 x 21	GBOC4221	1176
83 Half Width	40.5 x .5 x 21	GBOC4021	1127
76 Half Width	37 x .5 x 21	GBOC3721	1009
70 Half Width	34 x .5 x 21	GBOC3421	984
64 Half Width	31 x .5 x 21	GBOC3121	898

Standard Features

- 4 mm tempered glass
- Hung with Z-Strip mounting system

Notes

- Earth magnets are required to hold items securely in place
- Use glass cleaner or alcohol to clean
- Hung with Z-Strip mounting system
- Standard dry erase markers may be used

Notes

- Half width glassboards can be specified and combined with a Tackboard, Veneer panel, Marker Board. See "Half Width" items under product width.
- Specify right or left facing glassboard
- Use glass cleaner or alcohol to clean
- Standard dry erase markers may be used
- Earth magnets are required to hold items securely in place

Overhead dry marker board  
Full width dry marker boards

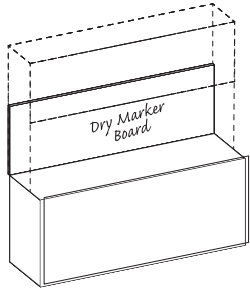

Product Width	Panel Dimension	SKU	List
93"	91 x .5 x 21	DMOC9121	1136
87"	85 x .5 x 21	DMOC8521	1061
83"	81 x .5 x 21	DMOC8121	1011
76"	74 x .5 x 21	DMOC7421	924
70"	68 x .5 x 21	DMOC6821	849
64"	62 x .5 x 21	DMOC6221	774
58"	56 x .5 x 21	DMOC5621	699
47"	45 x .5 x 21	DMOC4521	587
35"	33 x .5 x 21	DMOC3321	437
29"	27 x .5 x 21	DMOC2721	337

Overhead dry marker board  
Half width dry marker boards

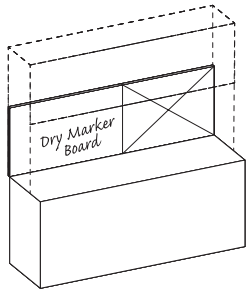

Standard Features

- Dry marker panel has edge trim molding
- Standard magnetic surface
- Hung with Z-Strip mounting system

Product Width	Panel Dimension	SKU	List
93 Half Width	45.5 x .5 x 21	DMOC4521	587
87 Half Width	42.5 x .5 x 21	DMOC4221	538
83 Half Width	40.5 x .5 x 21	DMOC4021	521
76 Half Width	37 x .5 x 21	DMOC3721	466
70 Half Width	34 x .5 x 21	DMOC3421	437
64 Half Width	31 x .5 x 21	DMOC3121	388

Standard Features

- Dry marker panel has edge trim molding
- Standard magnetic surface
- Hung with Z-Strip mounting system

Notes

- Half width dry marker boards can be specified and combined with a Tackboard, Veneer Panel, or Glass Board. See "Half Width" items under product width.
- Specify right or left facing dry marker board

# NOT SO square office

Single Height Wall Hung Overheads  
Open Endless Shelf Single Height

[Click here to view statement of line](#)

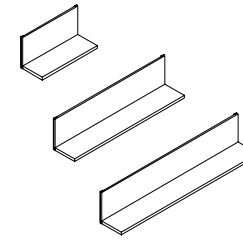

## 1 Select Model

w" x d" x h"	Weight
105 x 9 x 18	110
99 x 9 x 18	105
93 x 9 x 18	100
87 x 9 x 18	95
83 x 9 x 18	90
76 x 9 x 18	85
70 x 9 x 18	80
64 x 9 x 18	75
58 x 9 x 18	70
48 x 9 x 18	50
35 x 9 x 18	35
29 x 9 x 18	30

Standard Veneer Top Standard Veneer Chassis	Premium Veneer Top Premium Veneer Chassis	High Pressure Laminate Top Veneer Chassis	Thermally Fused Laminate Top Thermally Fused Laminate Chassis
NSS10518WH336W 3892	NSS10518WH336P 3777	"G" Option N/A	"M" Option N/A
NSS9918WH336W 3670	NSS9918WH336P 3561	"G" Option N/A	"M" Option N/A
NSS9318WH336W 3453	NSS9318WH336P 3798	"G" Option N/A	NSS9318WH336M 2092
NSS8718WH336W 3236	NSS8718WH336P 3561	"G" Option N/A	NSS8718WH336M 2014
NSS8318WH336W 3093	NSS8318WH336P 3403	"G" Option N/A	NSS8318WH336M 1949
NSS7618WH336W 2842	NSS7618WH336P 3127	"G" Option N/A	NSS7618WH336M 1887
NSS7018WH336W 2629	NSS7018WH336P 2892	"G" Option N/A	NSS7018WH336M 1843
NSS6418WH336W 2414	NSS6418WH336P 2655	"G" Option N/A	NSS6418WH336M 1728
NSS5818WH336W 2200	NSS5818WH336P 2420	"G" Option N/A	NSS5818WH336M 1647
NSS4818WH336W 1906	NSS4818WH336P 2098	"G" Option N/A	NSS4818WH336M 1333
NSS3518WH336W 1463	NSS3518WH336P 1609	"G" Option N/A	NSS3518WH336M 1095
NSS2918WH336W 1249	NSS2918WH336P 1375	"G" Option N/A	NSS2918WH336M 1010

## Product Features

- Mounting rails included

## Notes

- The DARRAN wall mounted cabinet(or shelf) must be hung on a weight-bearing wall. The suitability of the wall supporting the wall mounted cabinet, and the installation and maintenance of the wall-mounted cabinet, is the sole responsibility of the customer. Failure to correctly install and/or exceed the loaded weight capacity of this product may cause it to fall, resulting in damage to the product, adjacent property and/or bodily injury.

- Max load per inch is 3lbs

## Options

### Task Lighting

Overhead task light cord is located on the right facing side. If the opposite location is required please contact customer service.

- LT-LED24: 24" LED Task light - \$215
- LT-LED48: 48" LED Task light - \$270
- LT-LED60: 60" LED Task light - \$335
- LT-LED72: 72" LED Task light - \$360

## 2 Select Finish

[Click to view finishes](#)

[Click to view finishes](#)

[Click to view finishes](#)

## 3 Select Edge

Edge  
N/A

Edge  
N/A

Edge  
N/A

## 4 Select Hardware

Hardware  
N/A

Hardware  
N/A

Hardware  
N/A

# NOT SO square office

Double Height Wall Hung Overheads  
Open Endless Shelf Double Height

[Click here to view statement of line](#)

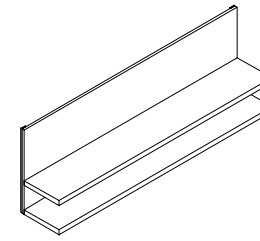

## 1 Select Model

w" x d" x h"	Weight
105 x 9 x 29	180
99 x 9 x 29	170
93 x 9 x 29	160
87 x 9 x 29	150
83 x 9 x 29	140
76 x 9 x 29	130
70 x 9 x 29	120
64 x 9 x 29	110
58 x 9 x 29	100
48 x 9 x 29	80
35 x 9 x 29	60
29 x 9 x 29	50

Standard Veneer Top Standard Veneer Chassis	Premium Veneer Top Premium Veneer Chassis	High Pressure Laminate Top Veneer Chassis	Thermally Fused Laminate Top Thermally Fused Laminate Chassis
NSS10529WH336W 4620	NSS10518WH336P 5082	"G" Option N/A	"M" Option N/A
NSS9929WH336W 4354	NSS9918WH336P 4791	"G" Option N/A	"M" Option N/A
NSS9329WH336W 4089	NSS9329WH336P 4499	"G" Option N/A	NSS9329WH336M 2464
NSS8729WH336W 3833	NSS8729WH336P 4217	"G" Option N/A	NSS8729WH336M 2380
NSS8329WH336W 3661	NSS8329WH336P 4027	"G" Option N/A	NSS8329WH336M 2296
NSS7629WH336W 3359	NSS7629WH336P 3696	"G" Option N/A	NSS7629WH336M 2216
NSS7029WH336W 3102	NSS7029WH336P 3412	"G" Option N/A	NSS7029WH336M 2162
NSS6429WH336W 2842	NSS6429WH336P 3127	"G" Option N/A	NSS6429WH336M 2026
NSS5829WH336W 2586	NSS5829WH336P 2845	"G" Option N/A	NSS5829WH336M 1930
NSS4829WH336W 2234	NSS4829WH336P 2458	"G" Option N/A	NSS4829WH336M 1554
NSS3529WH336W 1706	NSS3529WH336P 1876	"G" Option N/A	NSS3529WH336M 1267
NSS2929WH336W 1450	NSS2929WH336P 1594	"G" Option N/A	NSS2929WH336M 1164

## Product Features

- Mounting rails included

## Notes

- The DARRAN wall mounted cabinet(or shelf) must be hung on a weight-bearing wall. The suitability of the wall supporting the wall mounted cabinet, and the installation and maintenance of the wall-mounted cabinet, is the sole responsibility of the customer. Failure to correctly install and/or exceed the loaded weight capacity of this product may cause it to fall, resulting in damage to the product, adjacent property and/or bodily injury.

- Max load per inch is 6lbs

## Options

### Task Lighting

Overhead task light cord is located on the right facing side. If the opposite location is required please contact customer service.

- LT-LED24: 24" LED Task light - \$215
- LT-LED48: 48" LED Task light - \$270
- LT-LED60: 60" LED Task light - \$335
- LT-LED72: 72" LED Task light - \$360

## 2 Select Finish

[Click to view finishes](#)

[Click to view finishes](#)

[Click to view finishes](#)

## 3 Select Edge

Edge  
N/A

Edge  
N/A

Edge  
N/A

## 4 Select Hardware

Hardware  
N/A

Hardware  
N/A

Hardware  
N/A



# NOT SO square office

Overhead Bookcases  
Panel Doors / Storage

[Click here to view statement of line](#)

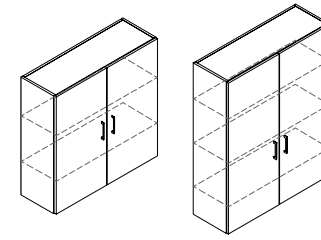

## 1 Select Model

w" x d" x h"	Weight
42" Height	
42 x 14 x 42	150
35 x 14 x 42	130
29 x 14 x 42	120
54" Height	
42 x 14 x 54	165
35 x 14 x 54	145
29 x 14 x 54	135

	Standard Veneer Top Standard Veneer Chassis	Premium Veneer Top Premium Veneer Chassis	High Pressure Laminate Top Veneer Chassis	Thermally Fused Laminate Top Thermally Fused Laminate Chassis
	NSS4242OH383W 2694	NSS4242OH383P 2964	"G" Option N/A	NSS4242OH383M 1515
	NSS3542OH383W 2344	NSS3542OH383P 2578	"G" Option N/A	NSS3542OH383M 1422
	NSS2942OH383W 2251	NSS2942OH383P 2476	"G" Option N/A	NSS2942OH383M 1383
	NSS4254OH383W 2950	NSS4254OH383P 3246	"G" Option N/A	NSS4254OH383M 1667
	NSS3554OH383W 2572	NSS3554OH383P 2829	"G" Option N/A	NSS3554OH383M 1576
	NSS2954OH383W 2472	NSS2954OH383P 2719	"G" Option N/A	NSS2954OH383M 1533

## Product Features

- 54" H unit has 1 adjustable shelf behind door
- Adjustable shelves (Full Storage), 42" - 2 shelves, 54" - 3 shelves
- Interior shelf depth 12"
- Interior cabinet depth 12.5"
- "W" styles - 42" H units finished top, 54" H units black painted top

## Notes

- 1 Lock needed
- Unit has black back panel and is not designed for Open Plan use. Select OPB Option for Open Plan application.

## Options

### Door

- D2: Door Lock - \$100 per door set
- D6: Delete Doors - n/c
- D9SC: Soft Close Door Hinges - \$20 per door
- WPD3061: Designer White - \$80 per door

### Interior Cabinet Lighting

- LEDPK starter kit includes Infeed, 1 Puck Interior Light and the ability to daisy chain up to 6 total Puck Lights
- LED Puck Starter Kit - \$310
- PK: 1 LED Interior Light - \$130

### Open Plan \_ Finished Back

- OPB: "W" "G" Style - Modify Unit for Open Plan Application - \$295
- OPBM: "M" Style - Modify Unit for Open Plan Application - \$95

### Shelf

- S714F: Heavy Duty Lumber 1" Shelves - \$80 per shelf ("M" Styles - n/a)
- GS14F: Replace Standard Shelves with Glass Shelves - \$90 per shelf

## 2 Select Finish

[Click to view finishes](#)

[Click to view finishes](#)

[Click to view finishes](#)

## 3 Select Edge

Edge  
N/A

Edge  
N/A

Edge  
N/A

## 4 Select Hardware



# NOT SO square office

Freestanding Half Towers  
Wardrobe / Storage

[Click here to view statement of line](#)

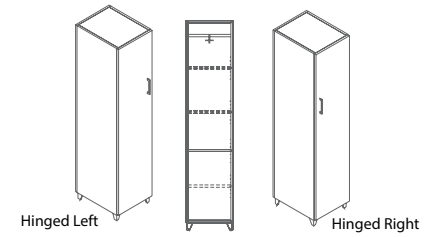

## 1 Select Model

w" x d" x h"  
Door Hinged Left  
16 x 21 x 83  
16 x 21 x 71  
Door Hinged Right  
16 x 21 x 83  
16 x 21 x 71

Weight	Standard Veneer Top Standard Veneer Chassis		Premium Veneer Top Premium Veneer Chassis		High Pressure Laminate Top Veneer Chassis	Thermally Fused Laminate Top Thermally Fused Laminate Chassis
180	NSS1683TW283W	4097	NSS1683TW283P	4506	"G" Option N/A	NSS1683TW283M 1961
165	NSS1671TW283W	3896	NSS1671TW283P	4286	"G" Option N/A	NSS1671TW283M 1736
180	NSS1683TW284W	4097	NSS1683TW284P	4506	"G" Option N/A	NSS1683TW284M 1961
165	NSS1671TW284W	3896	NSS1671TW284P	4286	"G" Option N/A	NSS1671TW284M 1736

## Product Features

- Interior cabinet depth 12.5"
- Standard fixed shelf with 3 adjustable shelves and coat hook and rod
- Standard Silver Feet (optional White, Black)
- "W" styles - 71" H units finished top, 83" H units black painted top

## Notes

- Flush cut credenza ends when ganging towers to credenza
- Unit has black back panel and is not designed for Open Plan use. Select OPB Option for Open Plan application.

## Options

- Door**
- D2: Door Lock - \$100 per door set
  - D6: Delete Doors - n/c
  - D9SC: Soft Close Door Hinges - \$20 per door
  - WPD3061: Designer White - \$80 per door

- Feet**
- D8: Delete feet (extend fronts to floor) - n/c

### Open Plan \_ Finished Back

- OPB: "W" "G" Style - Modify Unit for Open Plan Application - \$295
- OPBM: "M" Style - Modify Unit for Open Plan Application - \$95

### Premium Finish Option

- MFB: Black Metal Finish - \$30 per foot
- MFW: White Metal Finish - \$30 per foot

## 2 Select Finish

[Click to view finishes](#)

[Click to view finishes](#)

[Click to view finishes](#)

## 3 Select Edge

Edge  
N/A

Edge  
N/A

Edge  
N/A

## 4 Select Hardware

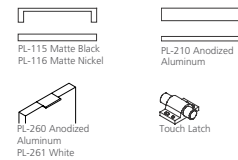
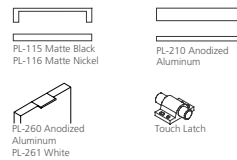
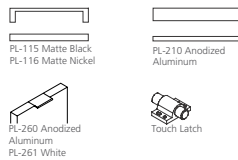

# NOT SO square office

Freestanding Half Towers  
Storage / File

[Click here to view statement of line](#)

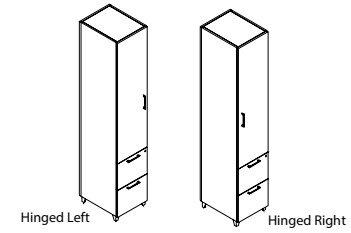

## 1 Select Model

w" x d" x h"  
Door Hinged Left  
16 x 21 x 83  
16 x 21 x 71  
Door Hinged Right  
16 x 21 x 83  
16 x 21 x 71

Weight	Standard Veneer Top Standard Veneer Chassis		Premium Veneer Top Premium Veneer Chassis		High Pressure Laminate Top Veneer Chassis	Thermally Fused Laminate Top Thermally Fused Laminate Chassis	
190	NSS1683TW291W	4268	NSS1683TW291P	4696	"G" Option N/A	NSS1683TW291M	2366
175	NSS1671TW291W	4061	NSS1671TW291P	4468	"G" Option N/A	NSS1671TW291M	2142
190	NSS1683TW292W	4268	NSS1683TW292P	4696	"G" Option N/A	NSS1683TW292M	2366
175	NSS1671TW292W	4061	NSS1671TW292P	4468	"G" Option N/A	NSS1671TW292M	2142

## Product Features

- Interior cabinet depth 12.5"
- Includes coat hook and rod
- Soft close suspension drawer(s)
- Standard fixed shelf with 2 adjustable shelves (71")
- Standard fixed shelf with 3 adjustable shelves (83")
- Standard Silver Feet (optional White, Black)
- "W" styles - 71" H units finished top, 83" H units black painted

## Notes

- Flush cut credenza ends when ganging towers to credenza
- Unit has black back panel and is not designed for Open Plan use. Select OPB Option for Open Plan application.

## 2 Select Finish

[Click to view finishes](#)

[Click to view finishes](#)

[Click to view finishes](#)

## 3 Select Edge

Edge  
N/A

Edge  
N/A

Edge  
N/A

## 4 Select Hardware

PL-115 Matte Black  
PL-116 Matte Nickel

PL-210 Anodized  
Aluminum

PL-115 Matte Black  
PL-116 Matte Nickel

PL-210 Anodized  
Aluminum

PL-115 Matte Black  
PL-116 Matte Nickel

PL-210 Anodized  
Aluminum

PL-115 Matte Black  
PL-116 Matte Nickel

PL-210 Anodized  
Aluminum

PL-260 Anodized  
Aluminum  
PL-261 White

PL-260 Anodized  
Aluminum  
PL-261 White

PL-260 Anodized  
Aluminum  
PL-261 White

PL-260 Anodized  
Aluminum  
PL-261 White

## Options

### Door

- D2: Door Lock - \$100 per door set
- D6: Delete Doors - n/c
- D9SC: Soft Close Door Hinges - \$20 per door
- WPD3061: Designer White - \$80 per door

### Drawer

- P6: Modify File/File to Box/Box/File - \$55 per pedestal
- P33: Wood Drawer Upgrade - \$45 per drawer

### Feet

- D8: Delete feet (extend fronts to floor) - n/c

### Open Plan \_ Finished Back

- OPB: "W" "G" Style - Modify Unit for Open Plan Application - \$295
- OPBM: "M" Style - Modify Unit for Open Plan Application - \$95

### Premium Finish Option

- Specify foot Metal Finish color - \$30 per foot (4 feet) MFB: Black, MFW: White

# NOT SO square office

Freestanding Towers  
Storage / File- Mini-Wardrobe

[Click here to view statement of line](#)

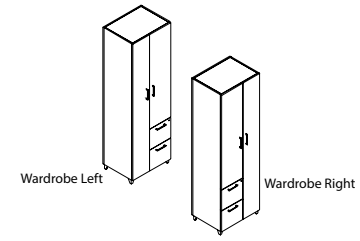

## 1 Select Model

w" x d" x h"  
Wardrobe Left  
26 x 21 x 83  
26 x 21 x 71  
Wardrobe Right  
26 x 21 x 83  
26 x 21 x 71

Weight	Standard Veneer Top Standard Veneer Chassis		Premium Veneer Top Premium Veneer Chassis		High Pressure Laminate Top Veneer Chassis	Thermally Fused Laminate Top Thermally Fused Laminate Chassis	
--------	--	--	--	--	--	--	--

265	NSS2683TW293W	5126	NSS2683TW293P	5640	"G" Option N/A	NSS2683TW293M	2710
240	NSS2671TW293W	4897	NSS2671TW293P	5387	"G" Option N/A	NSS2671TW293M	2413
265	NSS2683TW294W	5126	NSS2683TW294P	5640	"G" Option N/A	NSS2683TW294M	2710
240	NSS2671TW294W	4897	NSS2671TW294P	5387	"G" Option N/A	NSS2671TW294M	2413

## 2 Select Finish

[Click to view finishes](#)

[Click to view finishes](#)

[Click to view finishes](#)

## 3 Select Edge

Edge  
N/A

Edge  
N/A

Edge  
N/A

## 4 Select Hardware

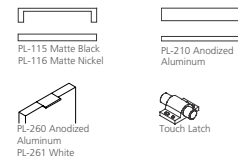
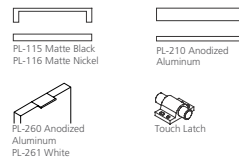
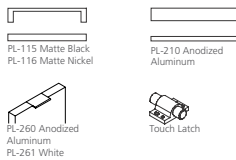

## Product Features

- Interior cabinet depth 12.5"
- Includes coat hook and rod
- Full extension drawers
- Locking drawers
- Soft close suspension drawer(s)
- Standard fixed shelf with 2 adjustable shelves (71")
- Standard fixed shelf with 3 adjustable shelves (83")
- Standard Silver Feet (optional White, Black)
- "W" styles - 71" H units finished top, 83" H units black painted

## Notes

- Flush cut credenza ends when ganging towers to credenza

## Options

### Door

- D2: Door Lock - \$100 per door set
- D6: Delete Doors - n/c
- D9SC: Soft Close Door Hinges - \$20 per door
- WPD3061: Designer White - \$80 per door

### Drawer

- P6: Modify File/File to Box/Box/File - \$55 per pedestal
- P33: Wood Drawer Upgrade - \$45 per drawer

### Feet

- D8: Delete feet (extend fronts to floor) - n/c

### Open Plan \_ Finished Back

- OPB: "W" "G" Style - Modify Unit for Open Plan Application - \$295
- OPBM: "M" Style - Modify Unit for Open Plan Application - \$95

### Premium Finish Option

- Specify foot Metal Finish color - \$30 per foot (4 feet) MFB: Black, MFW: White

# NOT SO square office

Freestanding Towers  
Wardrobe / Storage Full Tower

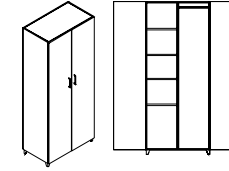

[Click here to view statement of line](#)

## 1 Select Model

w" x d" x h"  
83" Height  
35 x 21 x 83  
29 x 21 x 83  
71" Height  
35 x 21 x 71  
29 x 21 x 71

Weight	Standard Veneer Top Standard Veneer Chassis		Premium Veneer Top Premium Veneer Chassis		High Pressure Laminate Top Veneer Chassis	Thermally Fused Laminate Top Thermally Fused Laminate Chassis
310	NSS3583TW275W	5500	NSS3583TW275P	6051	"G" Option N/A	NSS3583TW275M 2698
265	NSS2983TW275W	5142	NSS2983TW275P	5657	"G" Option N/A	NSS2983TW275M 2616
285	NSS3571TW275W	4920	NSS3571TW275P	5412	"G" Option N/A	NSS3571TW275M 2401
240	NSS2971TW275W	4562	NSS2971TW275P	5019	"G" Option N/A	NSS2971TW275M 2319

## 2 Select Finish

[Click to view finishes](#)

[Click to view finishes](#)

[Click to view finishes](#)

Metal Finish

## 3 Select Edge

Edge  
N/A

Edge  
N/A

Edge  
N/A

## 4 Select Hardware

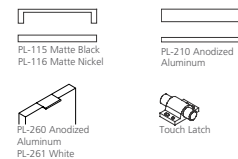
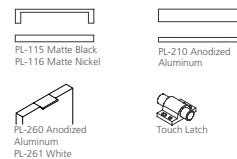
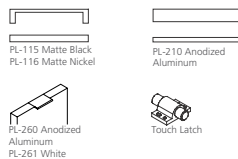

## Product Features

- Wardrobe left, storage right (includes coat hook and rod)
- Interior cabinet depth 12.5"
- Standard 2 fixed shelves with 2 adjustable shelves (71")
- Standard 2 fixed shelves with 3 adjustable shelves (83")
- Standard Silver Feet (optional White, Black)
- "W" styles - 71" H units finished top, 83" H units black painted top

## Notes

- Flush cut credenza ends when ganging towers to credenza
- Unit has black back panel and is not designed for Open Plan use. Select OPB Option for Open Plan application.
- When specifying MOD310P, 1 lock needed

## Options

### Door

- D2: Door Lock - \$100 per door set
- D6: Delete Doors - n/c
- D9SC: Soft Close Door Hinges - \$20 per door
- WPD3061: Designer White - \$80 per door

### Feet

- D8: Delete feet (extend fronts to floor) - n/c

### Open Plan \_ Finished Back

- OPB: "W" "G" Style - Modify Unit for Open Plan Application - \$295
- OPBM: "M" Style - Modify Unit for Open Plan Application - \$95

### Shelf

- MOD310P: Delete Center Partition / Add (3 - 71" / 4 - 83") Full Width Adj. Shelves & (1) Fixed - \$295

### Premium Finish Option

- Specify foot Metal Finish color - \$30 per foot (4 feet) MFB: Black, MFW: White

# NOT SO square office

Freestanding Towers  
Storage / File Full Tower

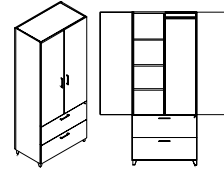

[Click here to view statement of line](#)

## 1 Select Model

w" x d" x h"  
83" Height  
35 x 21 x 83  
29 x 21 x 83  
71" Height  
35 x 21 x 71  
29 x 21 x 71

Weight	Standard Veneer Top Standard Veneer Chassis	Premium Veneer Top Premium Veneer Chassis	High Pressure Laminate Top Veneer Chassis	Thermally Fused Laminate Top Thermally Fused Laminate Chassis
350	NSS3583TW281W 5805	NSS3583TW281P 6388	"G" Option N/A	NSS3583TW281M 3075
325	NSS2983TW281W 5513	NSS2983TW281P 6065	"G" Option N/A	NSS2983TW281M 3019
325	NSS3571TW281W 5184	NSS3571TW281P 5703	"G" Option N/A	NSS3571TW281M 2777
295	NSS2971TW281W 4928	NSS2971TW281P 5420	"G" Option N/A	NSS2971TW281M 2712

## Product Features

- Includes coat hook and rod
- 71" has 2 adj. shelves / 1 fixed shelf
- 83" has 3 adj. shelves / 1 fixed shelf
- Adjustable shelf per door section
- Full extension drawers
- Locking drawers
- Features ball bearing suspensions, suspensions are full extension
- Standard Silver Feet (optional White, Black)
- "W" styles - 71" H units finished top, 83" H units black painted top
- Wardrobe left, storage right
- Flush cut credenza ends when ganging towers to credenza
- Unit has black back panel and is not designed for Open Plan use. Select OPB Option for Open Plan application.

## Notes

## Options

- Door**
- D2: Door Lock - \$100 per door set
  - D6: Delete Doors - n/c
  - D9SC: Soft Close Door Hinges - \$20 per door
  - WPD3061: Designer White - \$80 per door
- Drawer**
- P33: Wood Drawer Upgrade - \$45 per drawer
- Feet**
- D8: Delete feet (extend fronts to floor) - n/c
- Open Plan \_ Finished Back**
- OPB: "W" "G" Style - Modify Unit for Open Plan Application - \$295
  - OPBM: "M" Style - Modify Unit for Open Plan Application - \$95
- Shelf**
- MOD300P: Delete Center Partition / Add 2 (71") or 3 (83") Full Width Adj. Shelves - \$295
- Premium Finish Option**
- Specify foot Metal Finish color - \$30 per foot (4 feet) MFB: Black, MFW: White

## 2 Select Finish

[Click to view finishes](#)

[Click to view finishes](#)

[Click to view finishes](#)

## 3 Select Edge

Edge  
N/A

Edge  
N/A

Edge  
N/A

## 4 Select Hardware

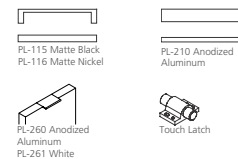
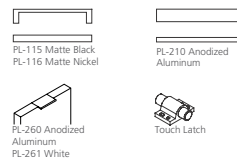
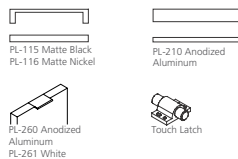

# NOT SO square office

Open Bookcases  
Freestanding

[Click here to view statement of line](#)

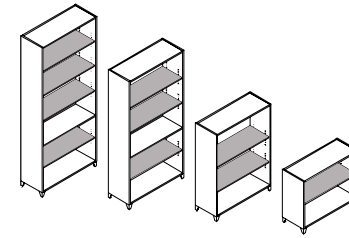

## 1 Select Model

w" x d" x h"	Weight
35" Width	
35 x 14 x 83	195
35 x 14 x 71	175
35 x 14 x 60	155
35 x 14 x 48	120
35 x 14 x 29	95
29" Width	
29 x 14 x 83	190
29 x 14 x 71	170
29 x 14 x 60	150
29 x 14 x 48	115
29 x 14 x 29	90

	Standard Veneer Top Standard Veneer Chassis	Premium Veneer Top Premium Veneer Chassis	High Pressure Laminate Top Veneer Chassis	Thermally Fused Laminate Top Thermally Fused Laminate Chassis
			"G" Option N/A	NSS3583BK250M 1709
	NSS3583BK250W 3952	NSS3583BK250P 4348	"G" Option N/A	NSS3571BK250M 1584
	NSS3571BK250W 3560	NSS3571BK250P 3916	"G" Option N/A	NSS3560BK250M 1493
	NSS3560BK250W 3167	NSS3560BK250P 3484	"G" Option N/A	NSS3548BK250M 1351
	NSS3548BK250W 2158	NSS3548BK250P 2374	"G" Option N/A	NSS3529BK250M 1041
	NSS3529BK250W 1916	NSS3529BK250P 2107		
			"G" Option N/A	NSS2983BK250M 1678
	NSS2983BK250W 3673	NSS2983BK250P 4040	"G" Option N/A	NSS2971BK250M 1551
	NSS2971BK250W 3308	NSS2971BK250P 3639	"G" Option N/A	NSS2960BK250M 1459
	NSS2960BK250W 2944	NSS2960BK250P 3240	"G" Option N/A	NSS2948BK250M 1315
	NSS2948BK250W 2007	NSS2948BK250P 2208	"G" Option N/A	NSS2929BK250M 991
	NSS2929BK250W 1778	NSS2929BK250P 1956	"G" Option N/A	

## Product Features

- 3/4" thick back
- Interior shelf depth 12"
- Metal legs standard
- Standard Silver Feet (optional White, Black)
- "W" styles - 29", 48", 60", and 71" H units finished top, 83" H units black painted top

## Notes

- Adjustable shelves shaded in gray
- Unit has black back panel and is not designed for Open Plan use. Select OPB Option for Open Plan application.

## Options

### Feet

- D8: Delete feet - n/c

### Interior Cabinet Lighting

- LEDPK starter kit includes Infeed, 1 Puck Interior Light and the ability to daisy chain up to 6 total Puck Lights
- LED Puck Starter Kit - \$310
- PK: 1 LED Interior Light - \$130

### Open Plan \_ Finished Back

- OPB: "W" "G" Style - Modify Unit for Open Plan Application - \$295
- OPBM: "M" Style - Modify Unit for Open Plan Application - \$95

### Shelf

- GS14F: Replace Standard Shelves with Glass Shelves - \$90 per shelf
- S714F: Heavy Duty Lumber 1" Shelves - \$80 per shelf ("M" Styles - n/a)

### Premium Finish Option

- Specify foot Metal Finish color - \$30 per foot (4 feet) MFB: Black, MFW: White

## 2 Select Finish

[Click to view finishes](#)

[Click to view finishes](#)

[Click to view finishes](#)

## 3 Select Edge

Edge  
N/A

Edge  
N/A

Edge  
N/A

## 4 Select Hardware

Hardware  
N/A

Hardware  
N/A

Hardware  
N/A

Interior drawer dimensions

UNIT DEPTH	DRAWER TYPE	OVERALL DIMENSIONS			INTERIOR DRAWER DIMENSIONS			NOTES
		W	D	H	W	D	H	
15-5/8" Letter	36" Box	13-1/8	19-11/16	4	12-1/8	18-11/16	3-7/16	Units less than 72"
	36" File	13-1/8	19-11/16	9-13/16	12-1/8	18-11/16	9-5/16	Units less than 72"
	30" Box	13-1/8	19-11/16	4	12-1/8	18-11/16	3-7/16	Units less than 72"
	30" File	13-1/8	19-11/16	9-13/16	12-1/8	18-11/16	9-5/16	Units less than 72"
	24" Box	13-1/8	16-1/16	4	12-1/8	15-1/16	3-7/16	Units less than 72"
	24" File	13-1/8	16-1/16	9-13/16	12-1/8	15-1/16	9-5/16	Units less than 72"
29" Lateral	24" Box	26-1/2	16-1/16	4	25-1/2	15-1/16	3-7/16	Workstation Credenzas less than 82"
	24" File	26-1/2	16-1/16	9-13/16	25-1/2	15-1/16	9-5/16	Workstation Credenzas less than 82"
31" Lateral	24" File	28-9/16	16-1/16	9-13/16	27-9/16	15-1/16	9-5/16	Multi-File Lateral File
35" Lateral	24" Box	32-1/2	16-1/16	4	31-1/2	15-1/16	3-7/16	Workstation Credenzas over 83"
	24" File	32-1/2	16-1/16	9-13/16	31-1/2	15-1/16	9-5/16	Workstation Credenzas over 83"
41" Lateral	24" File	38-1/2	16-1/16	9-13/16	37-1/2	15-1/16	9-5/16	Wood Drawer Only

Filing for 24" Depth Units

13" Wide File Drawer - 16" Deep

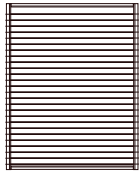

Letter Front to Back

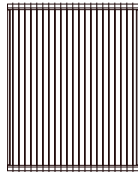

Legal Side to Side with File Rail

29" Lateral File Drawer

26-1/2" Wide File Drawer - 16-1/16" Deep

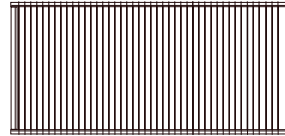

Legal Side to Side

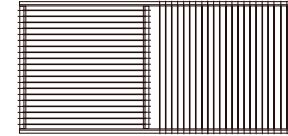

Legal Side to Side Letter Front to Back with File Rail



Letter Front to Back with File Rail

Filing for 30" & 36" Depth Units

13" Wide File Drawer - 20" Deep

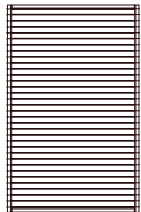

Letter Front to Back

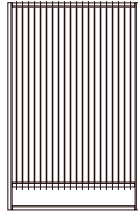

Legal Side to Side with File Rail

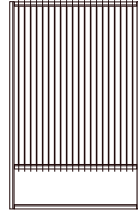

Letter Side to Side with File Rail

35" Lateral File Drawer

32-1/2" Wide File Drawer - 16-1/16" Deep

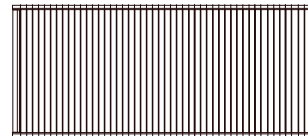

Legal Side to Side

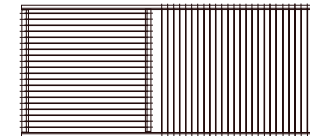

Legal Side to Side Letter Front to Back with File Rail

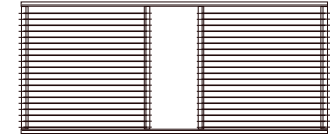

Letter Front to Back with File Rail





COMPUTER SUPPORT  
single monitor arm

Style Number	List Price
MA1	280



COMPUTER SUPPORT  
double monitor arm

Style Number	List Price
MA2	450



COMPUTER SUPPORT  
triple monitor arm

Style Number	List Price
MA3	530



COMPUTER SUPPORT  
quadruple monitor arm

Style Number	List Price
MA4	705

### Specifications

- Available in black or silver
- Desk clamp and mounting included
- Easy assembly and flexibility
- Elastic painting process for a durable and beautiful finish
- Gas spring tension adjustment for counter-balance height adjustment for monitors 1-8 KG
- Gas spring tested to 50,000 repetitions
- Hidden cable management

### Specifications

- Available in black or silver
- Desk clamp and mounting included
- Easy assembly and flexibility
- Elastic painting process for a durable and beautiful finish
- Gas spring tension adjustment for counter-balance height adjustment for monitors 1-8 KG
- Gas spring tested to 50,000 repetitions
- Hidden cable management

### Specifications

- Available in black or silver
- Desk clamp and mounting included
- Easy assembly and flexibility
- Elastic painting process for a durable and beautiful finish
- Gas spring tension adjustment for counter-balance height adjustment for monitors 1-8 KG
- Gas spring tested to 50,000 repetitions
- Hidden cable management

### Specifications

- Available in black
- Desk clamp and mounting included
- Easy assembly and flexibility
- Elastic painting process for a durable and beautiful finish
- Gas spring tension adjustment for counter-balance height adjustment for monitors 1-8 KG
- Gas spring tested to 50,000 repetitions
- Hidden cable management

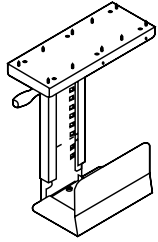

COMPUTER SUPPORT  
cpu retractable cradle

Style Number	List Price
K18	205

### Specifications

- Black Metal CPU Carriage
- Full 360° swivel capability allows easy access to rear of CPU for cables / wires
- Track allows 8- 1/2" extension
- Width Adjustment 5-1/2" to 9-1/4"
- Height adjustment 14- 5/8" to 20- 1/2"
- Black epoxy finish

Notes  
- Factory Installed

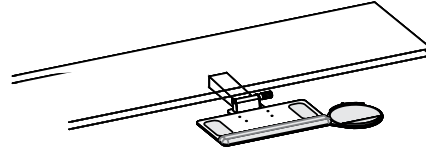

COMPUTER SUPPORT  
articulating keyboard tray

Style Number	List Price
Factory Installed K28	390
Field Installed K28F	415

### Specifications

- Adjusts effortlessly - A simple one-handed motion allows the keyboard to be repositioned instantly, without the use of locks or levers
- Encourages low-risk postures - Maximizes adjustability within a safe operating range.
- Will last a lifetime - Exceeds all applicable BIFMA Standards and comes with a lifetime guarantee.

Notes  
- Available on: Freestanding Desk  
- Factory Installed (standard)  
- FIELD INSTALL - \$415



DOOR MODIFICATIONS  
soft close door hinge

Style Number	List Price
D9SC	20 Per door

### Specifications

- Snap onto standard door hinge
- Requires (2) per door
- Max door height 43"
- Factory installed where specified
- Individually shipped for field installation

Notes  
- Specify Each Item To Have Slow Close Feature

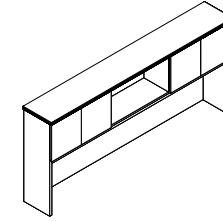

DOOR MODIFICATIONS  
delete doors

Style Number	List Price
D6	N/C

### Specifications

- Standard Door overheads and cabinets can have door deleted for open access. Modification of hinge rails and structural components are made face ready.

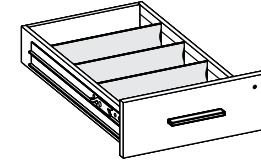
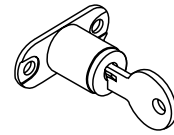
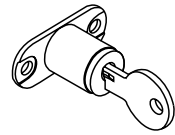
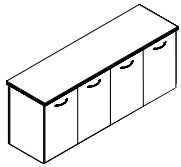

**DOOR MODIFICATIONS**  
delete doors/replace black laminate shelf w/ finished shelf

Style Number	List Price
D6A	N/C

**DOOR MODIFICATIONS**  
panel door lock

Style Number	List Price
D2	100 Per door set

**DOOR MODIFICATIONS**  
glass door lock

Style Number	List Price
D2-G	205 Per door set

**DRAWER OPTIONS**  
box drawer accessories

Style Number	List Price
Wood Drawer Dividers w/ Clips K-DIV	SET OF 3 - 30
Single Tray - Utility Tray K-Sut	35 ea.

**Specifications**

- Delete doors and replace black laminate shelf with finished shelf

Notes  
- Available on: All Storage "W"/"G" Style Credenzas.

**Specifications**

- Door Locks - 1 Door w/ Lock, Other Door w/ Catch Latch
- Contact Customer Service regarding limited lock locations and keying.

Notes  
- Available on: Panel Doors, Wood Frame Doors, and Silverluma doors

**Specifications**

- Door Locks - 1 Door w/ Lock, Other Door w/ Catch Latch
- Contact Customer Service regarding limited lock locations and keying.

Notes  
- Available on: Glass Doors

**Specifications**

- K-DIV Extra Wood Drawer Dividers with Clips, Top Box drawers standard with 1 divider
- K-SUT Single Tray - Utility Tray, Specify Legal or Letter drawer width

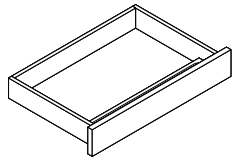

**DRAWER OPTIONS**  
finished center drawer

Style Number	List Price
K31	205
Add Skirt Option K31-SK	310

### Specifications

- Veneer drawer front finished to match unit W or G style veneer.
- Ball bearing smooth operation
- Drawer has lifetime guarantee
- Standard with matching wood grain pencil tray
- Laminate drawer front to match laminate unit (M style)

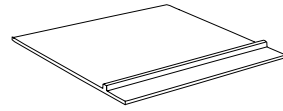

**DRAWER OPTIONS - BOTTOM COVER**  
felt bottom center drawer insert liner

Style Number	List Price
K3	100

### Specifications

- Inserts into center drawer and features divider for open pen and pencil storage. Removable for easy cleaning.
- Adds a luxurious touch to center drawers.
- Color: Dark Brown Coal

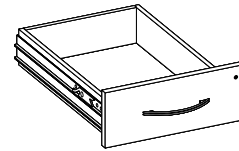

**DRAWER OPTIONS - UPGRADE**  
wood drawer upgrade

Style Number	List Price
P33	45 Per drawer

### Specifications

- Dowel joint construction
- Hardwood veneer multi-ply drawer
- UV finish
- 1/4" Wood veneer bottoms
- File drawer bottoms are five block reinforced for heavy weight capacity
- Lifetime guaranteed

**GLASSBOARD ACCESSORIES**  
glassboard accessory kit

Style Number	List Price
GBKIT	290

### Specifications

- 8 Earth magnets, 1 magnetic marker cup holder and 1 magnetic dry eraser

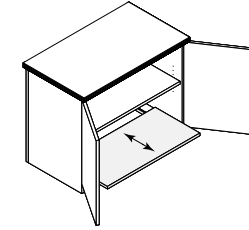
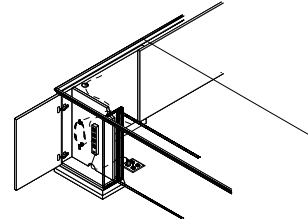
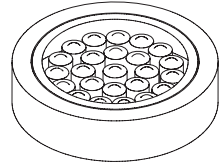

**TASK LIGHTING**  
lt-led task light

Style Number	List Price
LT-LED24	215
LT-LED48	270
LT-LED60	335
LT-LED72	360

**Specifications**

- 6.5' Power cord. Switch with touch dimmer
- 36 LEDs per foot
- 4.6 Watts per foot
- 91 Lumens per watt
- Please note when ganging.
- Overhead tasklight cord is located on the right facing side. If the opposite location is required please contact customer service.

**LIGHTING**  
led interior cabinet puck light

Style Number	List Price
Starter Kit	
LEDPK	310
1 LED Interior Puck Light	
PK	130

**Specifications**

- Starter kit includes Infeed, 1 Puck Interior Light and the ability to daisy chain up to 6 total Puck Lights
- (1) LED Puck Light with 30W power drive and switch
- Recessed fixture
- 12V linking cord 98"L
- Silver finish
- 50,000 hour life
- 2 watt per light

**Notes**

- Available on: Overhead/Tower Units with glass doors or no doors
- Power drive included, Light only

**PEDESTAL MODIFICATIONS**  
breakfront pedestal with wire management cavity door

Style Number	List Price
PC10	100
Power Supply Cordset	
PD717	100

**Specifications**

- Hinged pedestal front door offers easy access for wire management
- Wire hooks provide wire coil storage
- Wire access openings allow access to floor, cabinets interior and kneespace
- Cabinet interior is black finish
- Top grommet is positioned over cavity for access ease
- (Power Strip Optional)

**Notes**

- Breakfront Chassis Only

**PEDESTAL MODIFICATIONS**  
black laminate printer pullout bottom shelf

Style Number	List Price
PPOS	225

**Specifications**

- Black Laminate pullout shelf on suspension
- Black grommet
- Adjustable Shelf

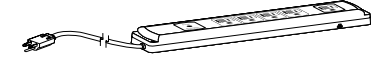
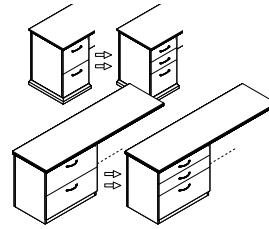
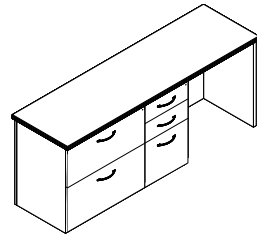
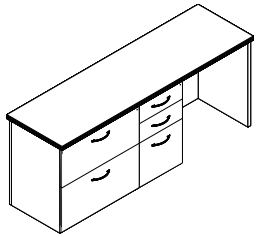

**PEDESTAL MODIFICATIONS**  
add veneer kneespace cabinets - no base

Style Number	List Price
Add Box/Box/File or File/File P40W	910
Add Lateral File 29" W P41W	1025
Add Multi-File - 31"W P42W	1140
Add Storage With Doors 29"W P43W	1025
Add CPU /Printer Cabinet - Open P44W	1025

**Specifications**

- Multi-file specify Box/Box Left or Right

Notes  
- Add additional Standard Cabinets To Kneespace Area.

**PEDESTAL MODIFICATIONS**  
add melamine (TFL) kneespace cabinets - no base

Style Number	List Price
Add Box/Box/File or File/File P40M	720
Add Lateral File 29" W P41M	890
Add Multi-File - 31"W P42M	1005
Add Storage With Doors 29"W P43M	800
Add CPU /Printer Cabinet - Open P44M	915

**Specifications**

- Multi-file specify Box/Box Left or Right

Notes  
- Available on: TFL products  
- Add additional Standard Cabinets To Kneespace Area.

**PEDESTAL MODIFICATIONS**  
modify drawer configurations

Style Number	List Price
File/File to Box/Box/File P6	55 Per ped
Box/Box/File to File/File P6	55 Per ped
Lateral File to 2 Box Drawers P8	100 Per ped

**Specifications**

- Modify File/File To Box/Box/File - Any Unit

**POWER / DATA**  
power supply cordset

Style Number	List Price
PD717	100

**Specifications**

- SIZE: 10.75"L x 2.0"W x 1.06"H  
- (5) Outlets w/ 10' cord  
- Surge suppression (720 Joules)  
- 15 Amp breaker  
- Available on: Vertical Panels, Cabinet Interiors, and under tops

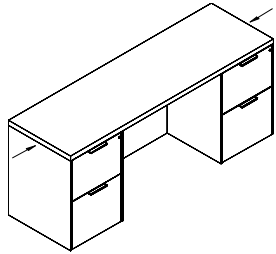

PRODUCT MODIFICATIONS  
modify width - open kneespace

Style Number	List Price
MOD-1	125

### Specifications

- Modify width down on any unit with an open kneespace: desk, workstation credenza, bridge, return

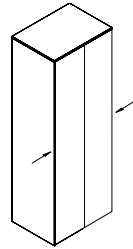

PRODUCT MODIFICATIONS  
modify width - open/closed storage

Style Number	List Price
MOD-2	250

### Specifications

- Modify width down on any unit with open or closed storage section: overheads, wall hung units, storage credenzas, towers

PRODUCT MODIFICATIONS  
modify width - outside of mod-1, mod-2

Style Number	List Price
MOD-3	Contact for pricing

### Specifications

- Width modification outside of MOD-1 & MOD-2

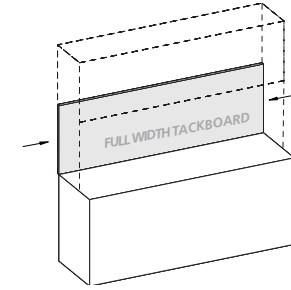

PRODUCT MODIFICATIONS  
modify width - tackboard, veneer panel, or a glassboard

Style Number	List Price
MOD-4	50

### Specifications

- Modify width down on tackboard, veneer panel, or a overhead glassboard

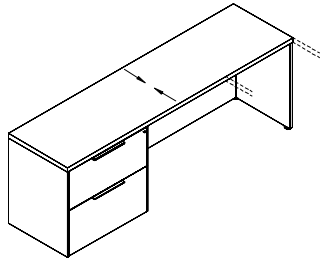

PRODUCT MODIFICATIONS  
modify depth - decrease depth

Style Number	List Price
MOD-5	125

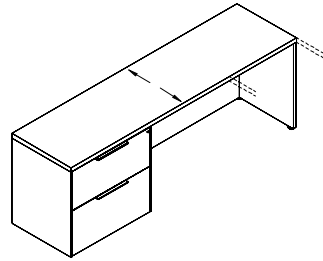

PRODUCT MODIFICATIONS  
modify depth - increase depth

Style Number	List Price
MOD-6	Add 10%

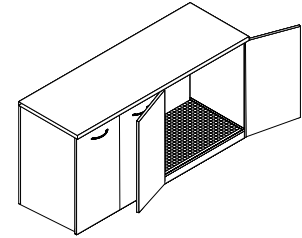

REFRIGERATOR MODIFICATION  
refrigerator cabinet modification

Style Number	List Price
REF01	205

### Specifications

- Modify depth down (minimum depth for a unit with drawers is 21"D)

Notes  
- Ex. 24" to 21", 30" to 24", and 36" to 30"

### Specifications

- Increase depth by no more than 6"

Notes  
- Ex. 24" to 30", 30" to 36", and 36" to 42"  
- Add 10% to the unit you want to increase the depth of by no more than 6"

### Specifications

- Modify height of a unit

### Specifications

- Open back cutout for venting  
- Moisture sponge mat  
- Contaminate ledge  
- Contact customer service for maximum refrigerator size (Changes based on unit).

Notes  
- Available on: 36" and 42" Storage Credenzas



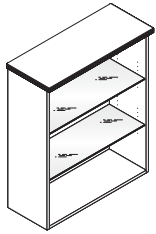

SHELF MODIFICATIONS

glass shelves - tempered full width  
26" - 35"

Style Number	List Price
26"W - 35"W x 14"D Shelf GS14F	90

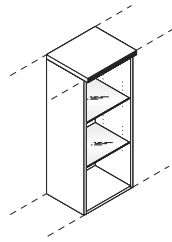

SHELF MODIFICATIONS

tempered glass shelves for half  
cabinet 17- 1/2" widths

Style Number	List Price
14-1/2"W - 17- 1/2"W x 14"D Shelf GS14H	70 ea.

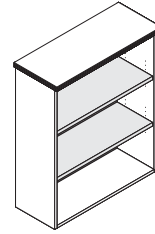

SHELF MODIFICATIONS

heavy duty solid wood bookcase  
replacement shelves

Style Number	List Price
1" Wood Shelf 14" Deep S714F	80 ea.
1" Wood Shelf 24" Deep S714FX	160 ea.

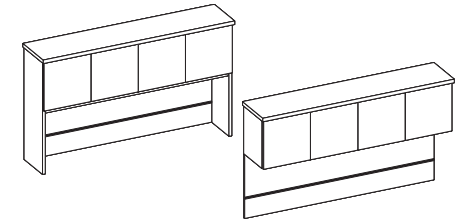

TOOL CHANNEL ACCESSORIES

recessed aluminum tool channel

Style Number	List Price
ATB02	5 per 1"W

Specifications

- Glass Shelves Replace Wood Shelf In Open Or Glass Door Cabinet. Also Order Interior Cabinet Lighting.

Specifications

- Glass Shelves Replace Wood Shelf In Open Or Glass Door Cabinet. Also Order Interior Cabinet Lighting.

Notes

- Replace only adjustable shelves between cabinet light and fixed lower wood shelf.

Specifications

- 1" Solid Lumber Core Shelves Replace Standard 3/4" Plywood Adjustable And Fixed Shelves

Specifications

- Anodized aluminum finish
- Fully recessed
- Finish matches anodized aluminum accessories
- Can be specified with fabric tack surface mounted above channel

Notes

- If using tool channel with wallhung overhead, a veneer panel must be specified.



TOOL CHANNEL ACCESSORIES  
iphone holder

Style Number	List Price
ATB31	125

### Specifications

- For Console/Wall Hung Back Panels With Optional Tool Bar
- 18 Gauge Steel - Stamp Formed
- Silver Powdercoat Finish
- 5" x 3 -3/4"W
- Non-slip Neoprene pad

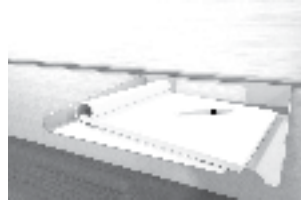

TOOL CHANNEL ACCESSORIES  
large shelf

Style Number	List Price
ATB35	135

### Specifications

- 12"W x 10"D

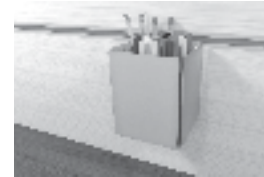

TOOL CHANNEL ACCESSORIES  
pencil pen holder

Style Number	List Price
ATB38	120

### Specifications

- For Console/Wall Hung Back Panels With Optional Tool Bar
- 18 Gauge Steel - Stamp Formed
- Silver Powdercoat Finish
- 5"H x 4"W x 4"D

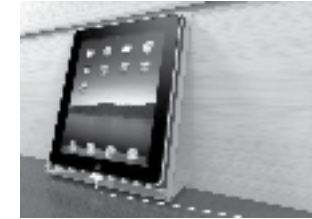

TOOL CHANNEL ACCESSORIES  
tablet holder

Style Number	List Price
ATB30	145

### Specifications

- For Console/Wall Hung Back Panels With Optional Tool Bar
- 18 Gauge Steel - Stamp Formed
- Silver Powdercoat Finish
- 10" x 8"W
- Non-slip Neoprene pad

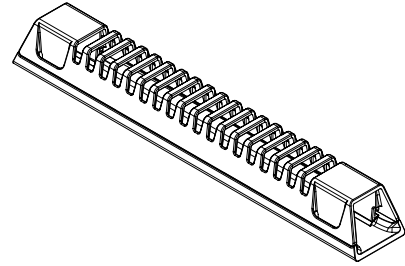
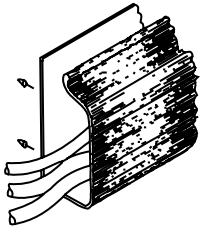

**WIRE MANAGEMENT**  
horizontal j-channel wire management raceway

**WIRE MANAGEMENT**  
horizontal wire management raceway

**WIRE MANAGEMENT**  
horizontal u-channel wire management raceway

**WIRE MANAGEMENT**  
coil wire manager

Style Number	List Price
W1	80 Per 4' section

Style Number	List Price
W21	35

Style Number	List Price
W2A	80 Per 4' section

Style Number	List Price
W18	160

**Specifications**

- 4' section for field installation.
- The "J" shape black thermoplastic wire raceway may be added to specified worksurface tops to provide concealed channeling of wires to and from worksurface grommets. For use in open kneespace areas, raceway is attachable to top of back panel with pan head screws. Interior dimensions are 1" x 1- 1/2" providing ample storage for multiple wires and excess cable. Front of raceway flexes out for easy cord insertion.

- Notes
- Units w/ Wire Channel Standard.
  - Field Installation

**Specifications**

- 10"W x 1.5"D x 1.25"H
- Grey Wire Manager (10.5")
- Power and data cables can be discretely housed and managed with the W21 Gray Wire Manager. This can be mounted in any location to metal frame or underside of conference tables and runs cables through a 1" channel from power module to hollow steel legs. This keeps cables organized under the table top. Release clips make it simple to snap on and off the Wire Manager for easy organization and access after attached to the table

- Notes
- Field installed

**Specifications**

- 4' section for field installation.
- Notes
- Units w/ Wire Channel Standard.
  - Field Installation

**Specifications**

- Weighted Base, Table attachment plate
  - 39- 1/2" Length
  - Black
- Notes
- Location

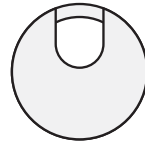
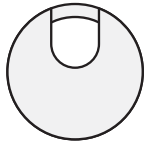

WIRE MANAGEMENT

standard location grommets - factory installed

Style Number	List Price
Standard Location Grommet	
Black	
TM30	50
Silver	
TM31	50
Antique Brass	
TM33	50
White	
TM34	50

WIRE MANAGEMENT

non-standard location grommets - factory installed

Style Number	List Price
Non-Standard Location Grommet	
Black	
TM30 -NS	95
Silver	
TM31 -NS	95
Antique Brass	
TM33 -NS	95
White	
TM34 -NS	95

WIRE MANAGEMENT

black plastic vertical surface grommets - factory installed

Style Number	List Price
Standard Location Grommet	
TM50-C	50
Non-Standard Location Grommet	
TM50-NS	95

Specifications

- 1 -5/8" Metal Grommet

Notes  
 - \*Units w/ Grommets Standard Are Noted Under Standard Features. Grommets Match Pull Finish - Standard (Unless Specified Otherwise)

Specifications

- 1 -5/8" Metal Grommet

Notes  
 - \*Units w/ Grommets Standard Are Noted Under Standard Features. Grommets Match Pull Finish - Standard (Unless Specified Otherwise)

Specifications

- 2 " Black Plastic Grommet

Notes  
 - Standard Location is Bottom Center

Aircharge wireless charging grommet

Style Number	List Price
 ACWG WIRELESS GROMMET	\$195

Specifications

- > When used with GROVE Tables an additional \$350 LIST will apply for the special cutout required.
- > AirCharge offers a convenient way to charge any Qi compatible smartphone or device without the need to carry charging cables or find an available power outlet.
- > The Aircharge is powered by the latest Qi compliant IC offering reliable and efficient wireless charging in a convenient 3" grommet hub. Simply place your phone on the Aircharge and an LED will confirm pairing and begin wireless charging.
- > Recess: Efficient space conservation and quick access
- > Input: DC 5V (with included AC power adapter), DC 9V, 1.67A (with optional QC 2.0 power adapter)
- > Output: 5 watts Max. with DC 5V, 2A power adapter, 10 watts Max. with QC 2.0 power adapter
- > Qi V1.2 compliant IC
- > Charging distance: 6mm Max.

Available: All DARRAN collections



Cove power unit - non-linking

Style Number	List Price
 PD-COVE PLUG Non-linking version	\$600

## Specifications

- > Size 5.75"L x 2.5"W
- > (2) 15 Amp Receptacles and (2) USB charging ports
- > Surface Mount
- > 108" Cord
- > Standard Silver Finish, Available in White or Black Finish upon request
- > ETL Listed

Available: All DARRAN collections



Cove corded series

Style Number	List Price
 PD-COVE-PKO	\$800

## Specifications

- > Size 9.5"L x 2.5"W x 3.18"D
- > When used with GROVE Tables an additional \$350 LIST will apply for the special cutout required.
- > (2) Power Receptacles, (2) 2.1 Amp USB charging ports and (1) Telecom Plate Knockout
- > Surface Mount
- > 108" Cord
- > Standard Silver Finish, Available in White or Black Finish upon request
- > ETL Listed

Available: All DARRAN collections

Telecom Plates	
RJ45 (1)	\$55
RJ45 (2)	\$110
RJ45 (3)	\$165
USB (1)	\$70
USB (2)	\$140
RJ11/RJ45	\$110
RJ45/USB	\$125
RJ45/HDMI	\$210
HDMI/DVI	\$325
HDMI/USB	\$205
HDMI/VGA	\$240
VGA/MINI-STEREO	\$155
VGA/USB	\$175

This pod can have up to 1 total plates.  
 \*All telecom connectors sold separately.



# DARRAN®

Soba wire manager

Style Number	List Price
STARTER UNITS	
SCDW	\$200
White wire manager	
SCDB	\$200
Black wire manager	

## Specifications

- > Dimensions: 9ft x 9in x 3.15in
- > Zips up, bundles and routes loose, messy cables into a single tube
- > Routes and guides cables behind desks, TVs, and anywhere cables tend to get messy
- > Accommodates large or small cables, up to three cables at once
- > Support channels, used to route cables, include powerful adhesive backing which allows easy attachment to surfaces.

Available: All DARRAN collections

## Power & Data Options





VILLA Power unit - non-linking

Style Number		List Price
VIL-C PLUG		\$515
Non-Linking		

Specifications

- > Size: Top Grommet 5.68"L X 3.39"W; Under Top 12"L x 3.13"W x 3.08"D
- > (2) Power receptacles; (2) USB charging ports and (1) Knockouts for RJ45 Data Ports
- > Surface Mount
- > 72" Cord (Longer cord available, contact Customer Service)
- > Standard Silver Finish, Black Finish available upon request
- > UL or ETL Certified

Available: All DARRAN collections, excludes Grove

RJ45 Knockout	
RJ45 (1)	\$55

