

DARRAN®



Capitol Park Price List

Effective April 1, 2024

Date	Page	Modification	Description
04.02.24		Updated Pricing	

Statement of Line
Features & Advantages1
Edges | Pulls | Knobs3
Grommets | Grommet Reference.....4
Ganging | Height Reference5
Modesty Reference | Doors | Grain Direction6
Drawer Dimensions | Filing Reference7
Finishes | Specifications8
Drawer Dimensions | Filing Reference9
Double Pedestal Desk.....10
Single Pedestal Desk.....11
Conference Desk13
Returns.....14
Bridges17
Freestanding Credenzas18
Lateral File21
Workstation Credenzas23
Single Height Freestanding Overheads26
Overhead Accessories.....28
Single Height Wall Hung Overheads.....31
Wall Hung Accessories32
Overhead Half Towers.....36
Overhead Bookcases38
Vertical Half Towers.....40
Vertical Full Towers.....41
Bookcases43
Options45
Power & Data.....58

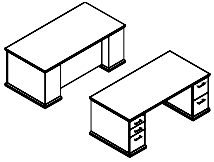

Page 10
Double Pedestal Desks
Executive / Breakfront

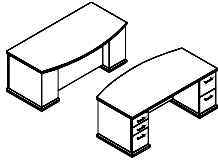

Page 11
Double Pedestal Desks
Bowfront / Breakfront

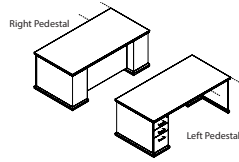

Page 12
Workstation Desks
Breakfront - Single Pedestal

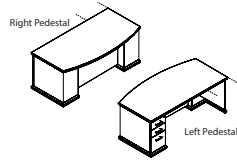

Page 13
Workstation Desks
Bowfront Breakfront - Single Pedestal

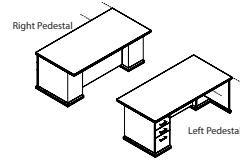

Page 14
Workstation Desks
Conference Overhang Breakfront
- Single Pedestal

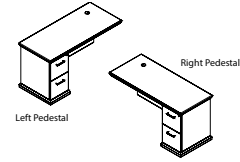

Page 15
"L" Workstation Returns
File/File

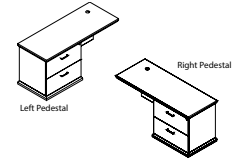

Page 16
"L" Workstation Returns
Lateral File

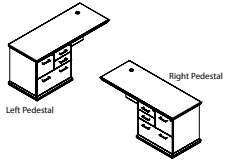

Page 17
"L" Workstation Returns
Box/Box/File/Lateral

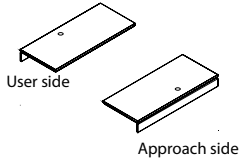

Page 18
Workstation Bridges
Open Back

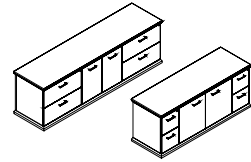

Page 19
Credenzas
File / Storage

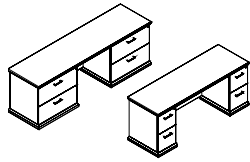

Page 20
Credenzas
Kneespace

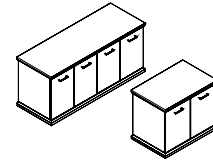

Page 21
Credenzas
Storage

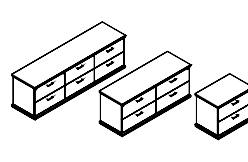

Page 22
Lateral File Credenzas
6/4/2 Drawers

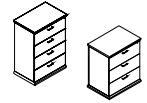

Page 23
Lateral File
Vertical Lateral File

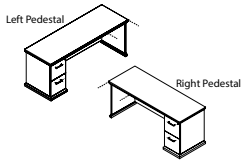

Page 23
Workstation Credenzas
File/File

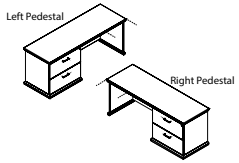

Page 24
Workstation Credenzas
Lateral File

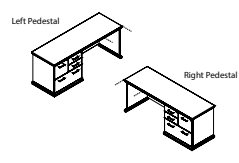

Page 25
Workstation Credenzas
Box/Box/File/Lateral

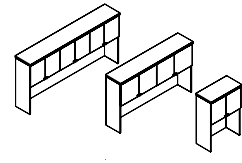

Page 26
Single Storage Overhead
Console
Panel Door - 6/4/2 Door

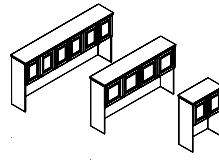

Page 27
Single Storage Overhead
Console
Wood Frame Door With Clear
Glass Inserts

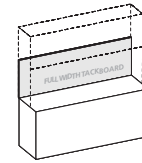

Page 28
Overhead Tackboards

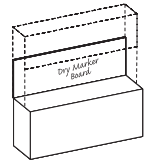

Page 29
Overhead Dry Marker Boards

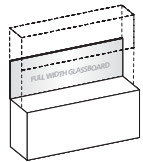

Page 30
Overhead Glassboards

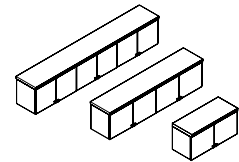

Page 31
Single Height Wall Hung Over-
heads
Panel Doors - 6/4/2 Door

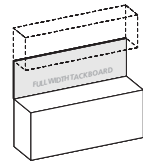

Page 32
Wall Hung Tackboards

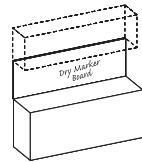

Page 33
Wall Hung Dry Marker Boards

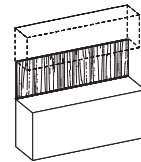

Page 34
Wall Hung Veneer Panels

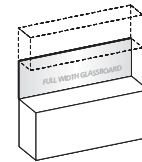

Page 35
Wall Hung Glassboards

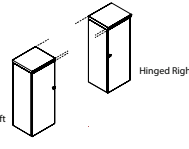

Page 36
Sit-On Tower Extension
Panel Door - Full Storage

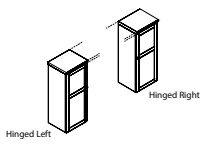

Page 37
Sit-On Tower Extension
Wood Frame Door/Clear Glass
Insert - Full Storage

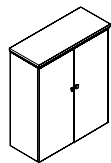

Page 38
Sit-On Bookcase Console
Panel Door

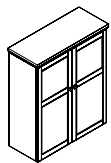

Page 39
Sit-On Bookcase Console
Frame Door With Clear Glass

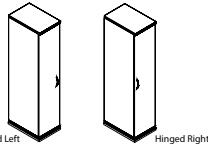

Page 40
Half Towers
Half Wardrobe - Left/Right Hinge

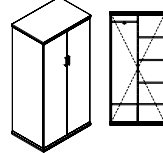

Page 41
Full Towers
Full Wardrobe

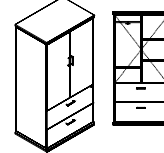

Page 42
Full Towers
2 Lateral File / Wardrobe

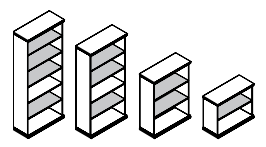

Page 43
Freestanding Bookcases
Open Bookcases

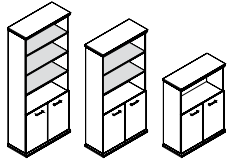

Page 45
Freestanding Bookcases
Bookcases W/ Doors

Veneer

DARRAN only uses HPVA AA Grade Flat Cut Cherry and Walnut Veneers. All veneers are selected and matched for balance and consistency.

Veneer tops

Capitol park veneer tops feature a 45-pound density substrate with balanced 3-ply construction. Tops are 1-1/8" thick on MDF core comprised of 100% recycled and recovered wood fibers. All veneer tops are slipmatched and feature a 3mm external solid hardwood band or profile edge.

Laminate tops

Capitol park high-pressure laminate tops feature a 45-pound density substrate with balanced 3-ply construction. Tops are 1-1/8" thick on MDF core comprised of 100% recycled and recovered wood fibers. All high pressure laminate tops are available with a profile edge, laminate self-edge or 2mm PVC edge band. Laminates in wood grain patterns feature a fine grain texture that features the polish and luxe of a real wood veneer with a subtle narrow grain structure.

Cleaning wood & laminate

In addition to regular dusting, give your furniture an occasional cleaning in accordance with our cleaning instructions. DARRAN wood and laminate products can be cleaned with a soft cloth and a mild soap and water mixture. Use approximately 32 oz of water mixed with one tablespoon of dish soap, always wiping with the grain. Dry with a soft cloth, going with the grain, to avoid spotting or streaking.

Wood products should be waxed periodically using a non-wax liquid; please do not use any waxy polish or cleaner. Interior of drawers may also be cleaned with mild soap and water mixture, or any household cleaner that is not petroleum or thinner-based.

Chassis & pedestal

Chassis components are 3/4" thick core of particle board or MDF rated EPP/SCS/CARB-II material with 3-ply balanced construction. Pedestal and Cabinets feature dowel construction reinforced with steel bracket plates, wood cleats, screws and glue. All units are standard with 1" adjustable glides that allow for leveling of units that are secured in solid wood glide blocks to prevent tearout.

Overhead cabinet construction Freestanding & wall mount

Freestanding Overhead storage cabinets are constructed of 1" and 3/4" thick core of particle board or MDF rated EPP/SCS/CARB-II material with 3-ply balanced construction. Panels are attached with cam fasteners in conjunction with dowels securely adhered with glue. All surface mount cabinets connect to work surface with anti-slip tape. Wall mount cabinets are mounted to the wall with steel "z" bracket attachment method using 5mm euro screws

to attach to the back of the cabinet. All units ship with a steel "z" bracket. This bracket is mounted to the wall by field installers. Installers are responsible for selecting and supplying appropriate fasteners for wall conditions.

Bookcase Construction

All chassis (sides, back, top and bottom panels) are constructed with 3/4" thick core of particle board or MDF rated EPP/SCS/CARB-II material with 3-ply balanced construction. Panels are attached with cam-lock fasteners in conjunction with dowels securely adhered with glue. Shelves on all units are 3/4" thick balance 3 ply panels. Optional heavy duty shelves are 1" thick lumber core balanced 5 ply construction.

Tackboards

Wall mount tackboards are constructed of .75" thick fiberboard. The fabric is precisely aligned and fitted to the tackboard with a sock on cover. Overhead storage tackboards are constructed of .75" thick fiberboard. The fabric is precisely aligned and fitted to the tackboard and adhered to the rigid hardboard with staples. Wall mount cabinets are mounted to the wall with steel "z" bracket attachment method using 5mm euro screws to attach to the back of the cabinet. All units ship with a steel "z" bracket. This bracket is mounted to the wall by field installers. Installers are responsible for selecting and supplying appropriate fasteners for wall conditions.

Adjustable glides

Glides provide 1" of vertical leveling adjustment. Glide bottom is durable metal. Glides are secured in solid wood blocks that are screwed and glued for durability.

Drawers

All drawers are constructed with mitre joint/dowel construction in a natural maple finish with four sides and a bottom, which are attached to a drawer front with screws for easy removal. Drawer fronts are vertically matched in balanced sets. Pencil trays are standard in all box drawers. Drawers are constructed of 1/2" thick wood grained wrapped 5 sided miter-folded construction with 1/4" thick hardboard bottoms reinforced for heavy weight capacity. Drawers have been tested and pass BIFMA 50,000 cycle test. All drawers are guaranteed lifetime with free replacement warranty.

Drawer fronts

Drawer fronts are vertically matched in balanced sets. Doors feature vertical veneer bookmatched horizontally in sets of 2 / 4 and 6 doors. All tower fronts matched in vertical sets.

Optional wood drawers

Optional hardwood veneer plywood drawers feature banded top and bottom edges for smoothness. Drawers are dowel joint construction with a UV cured finish over maple veneers, plus a lifetime free replacement guarantee.

Optional Wood Drawer (Any Size) – Option Code P33...\$40 List Price Per Drawer

Suspensions

All casegoods utilize cold rolled steel zinc plated high-grade drawer suspensions. Box and File drawers are full extension, featuring steel ball bearings for a smoother quieter range of motion with soft close operation and are rated 100lbs. Lateral file drawers are a progressive action full extension suspension with the soft close operation and is rated at 150lbs. Lateral files include anti tip mechanism that will allow only one drawer at a time to be opened. All suspensions are soft close and are warranted for the lifetime of the product.

Hinges

Units with doors include 95 degree swing hinges.

Filing

Capitol park features a highly durable black plastic extrusion that is securely fastened into a route on top of the drawer to support hanging files. An adjustable crossbar is provided for all file drawers that enables legal/letter filing front to back or side-to-side based on the drawer size.

Locks

Locks are Standard on all drawers below the worksurface. Random lock cores are installed at the factory. Some units may be shipped with the same key number. Locks are Silver, Black or Bronze and match pull finish unless otherwise specified.

DARRAN will also send lock cores separately to the dealer at your request. These units will be send with an empty lock core and the Dealer will receive a shipment of the requested lock core/keys.

Keying

Keying is available either factory or field installed. Factory installed keying is random.

Wire management

Wire management capabilities include standard and optional worksurface grommets. Specify W-1 under surface wire channels for organization and management of all communication wires and cords. Horizontal J-Channel wire management (Sku: W-1) is sold separately to conceal wire under worksurfaces.

Grommets

Metal grommets are provided to match the drawer pull selection. Grommet is available in black, silver, white or antique brass. Must specify standard or non-standard location. Black plastic grommets are available as an option for vertical applications.

Powerports

A large selection of power pods are available and handle power, data, docking stations and communication. See options section for selection.

LED Task Lights

LED task lighting provides high efficiency, low energy lighting with a long life. Surface mounted light is encased in silver aluminum channel with milk lense and rounded end caps. Lights are field installed. Product specifications listed below:

- Diffuser creates a softer light and eliminates hot spots
- Touch dimmer switch
- Can be “daisy chained” up to 90W
- 4.6 watts per foot
- 120 LEDs per meter
- Certification: UL Listed
- 50,000 hour life span.

Color Temp is 4000K

DARRAN

"W" & "G" Standard profile

Capitol Park Edge for "W" & "G" Styles
Hardwood Rim Band Species Same As
Surface Veneer

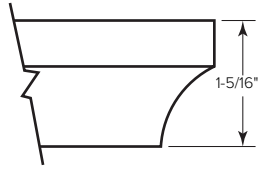

Hookup edge profile

Coped Edge

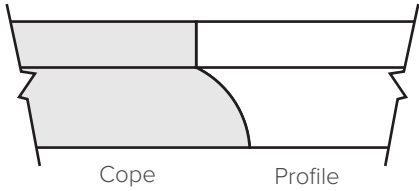

"W" & "G" Base profile

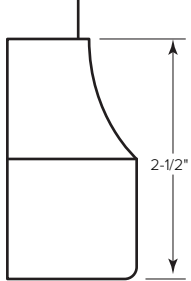

Solid Hardwood Base:
Bases are constructed of solid
hardwood lumber 2-1/2" x 1-5/8".
Corners are precisely mitred
and joined with solid hardwood
corner blocks screwed and
glued for durability. Non-mitred
single end bases are flushed
to kneespcae side to allow
modular cabinet use.

Pulls/knobs

Factory Installed

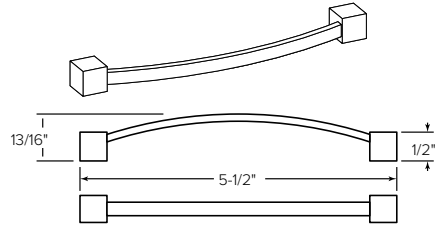

PL-125 Antique Pewter
PL-126 Antique English
PL-127 Matte Black

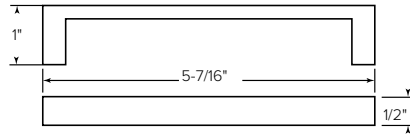
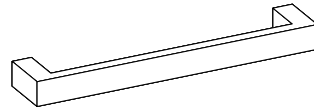

PL-115 Matte Black
PL-116 Matte Nickel

Capitol Park Edges | Pulls | Knobs

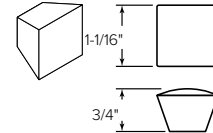

DK-125 Antique Pewter
DK-126 Antique English
DK-127 Matte Black

TM30
Black
1-5/8" Dia.

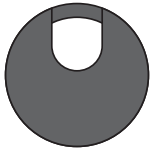

Optional grommets

Factory Installed

Grommets (Standard Location)

- Specify Color and Left/Right/Center - \$50 ea.
- Black: TM30-R (Right), TM30-L (Left), TM30-C (Center)
 - Silver: TM31-R (Right), TM31-L (Left), TM31-C (Center)
 - Antique Brass: TM33-R (Right), TM33-L (Left), TM33-C (Center)

Grommets (Non-Standard Location)

Provide drawing w/ Grommet Location and Specify Color - \$95 ea.

- Black: TM30-NS
- Silver: TM31-NS
- Antique Brass: TM33-NS

TM31
Silver
1-5/8" Dia.

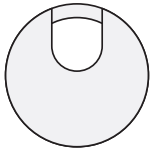

TM33
Antique Brass
1-5/8" Dia.

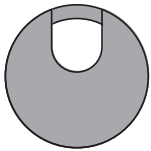

TM50
Black
1-5/8" Dia.



Grommets (vertical surface)

Standard Location - \$50 ea.

- Black Plastic Vertical Surface: TM50-C (Bottom Center)

Non-Standard Location - \$95 ea.

- Black Plastic Vertical Surface: TM50-NS



W1

Horizontal J-channel

Horizontal J-Channel wire management (Sku: W-1) is sold separately to conceal wire under worksurfaces.

Standard Grommet Location Reference

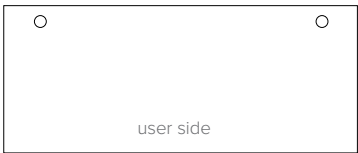

Desk
Specify Right or Left Grommet



6" Overhang Desk
Specify Right or Left Grommet

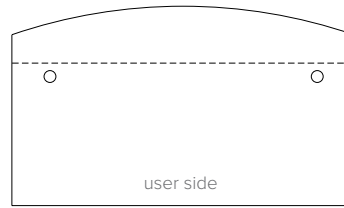

6"/12" Bow Front Desk
Specify Right or Left Grommet



Bridge
Center Grommet

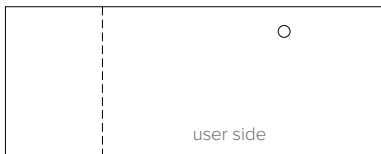

Return (Left Pedestal Shown)
Right Pedestal - Left Grommet
Left Pedestal - Right Grommet

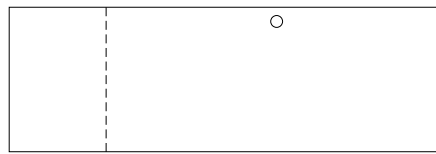

Workstation Credenza
Center Kneespace Grommet

Ganging – Flush Cut Modification

30”H Casegood Worksurface & Base Ganging Modifications

To gang two casegood units, each unit end to be ganged must be flush cut modified for gapless surfaces and cabinet chassis.

Order Option:

- FC-B: Flush Unit Both Sides(Facing) for Ganging - \$100
- FC-L: Flush Unit Left (Facing) for Ganging - \$100
- FC-R: Flush Unit Right (Facing) for Ganging - \$100

Flush cut modification per unit includes all modifications to gang to one end or both ends when units are ganged. Modification includes tops, base and molding.

Modification reduces width size approximately 1” per end.

Example:

CAP3024CA104W Two Drawer Lateral File (Left) Flush Cut Right – FC-R...\$100

CAP7124CA054W Kneespace Credenza (Right) Flush Cut Left – FC-L...\$100

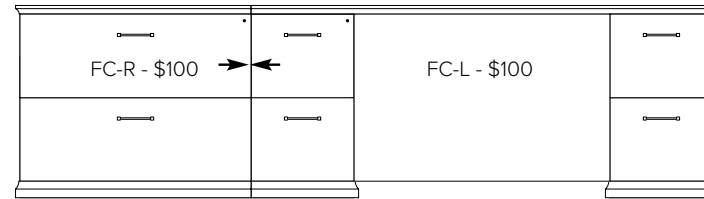

Height reference

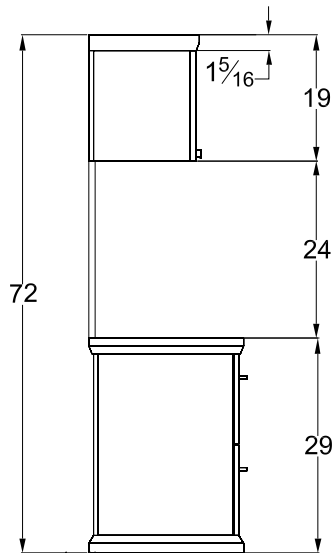

Typical Single Height Side Profile Wall Hung Overhead

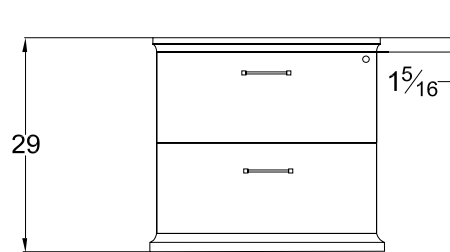

Pedestal Front Profile Lateral File

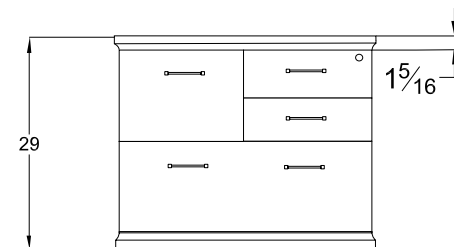

Pedestal Front Profile Multi-File

Modesty Reference

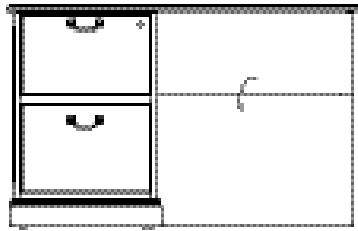

M34
Drop Door Tech Modesty

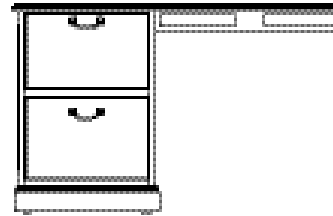
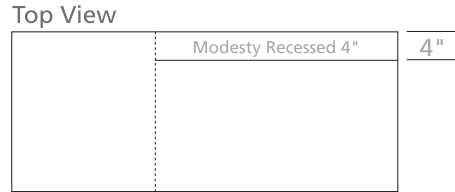

M51
Open Back Modesty with 4" Wire Management Rail

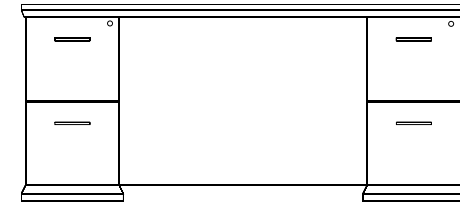

M37
Fixed Full Modesty

Overhead Door Detail

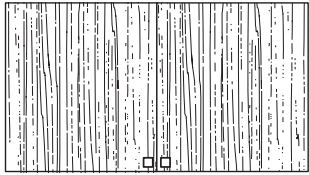

Panel Door

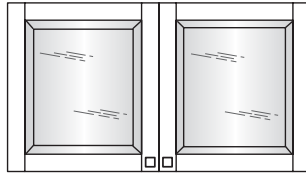

Beveled Glass Door

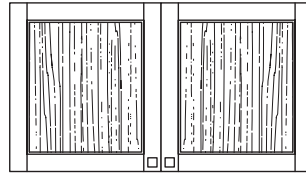

Solid Hardwood Frame
Door w/ Veneer Insert - Only
Available on "W" Styles

Grain Direction

Veneer chassis parts are vertical grain. Doors feature vertical veneer bookmatched horizontally in sets of 2,4, and 6 doors. Tower fronts are matched in vertical sets.

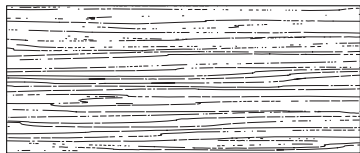

Desk

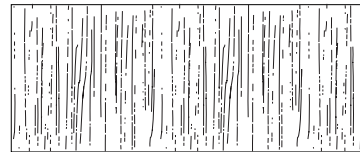

Runoff Desk

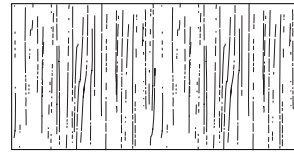

Bridge

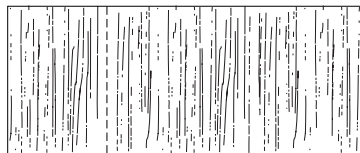

Return



Credenza

Interior Drawer Dimensions

UNIT DEPTH	DRAWER TYPE	OVERALL DIMENSIONS			INTERIOR DRAWER DIMENSIONS			NOTES
		W	D	H	W	D	H	
15-5/8" Letter	36" Box	13-1/8	19-11/16	4	12-1/8	18-11/16	3-7/16	Units less than 72"
	36" File	13-1/8	19-11/16	9-13/16	12-1/8	18-11/16	9-5/16	Units less than 72"
	30" Box	13-1/8	19-11/16	4	12-1/8	18-11/16	3-7/16	Units less than 72"
	30" File	13-1/8	19-11/16	9-13/16	12-1/8	18-11/16	9-5/16	Units less than 72"
	24" Box	13-1/8	16-1/16	4	12-1/8	15-1/16	3-7/16	Units less than 72"
29" Lateral	24" File	13-1/8	16-1/16	9-13/16	12-1/8	15-1/16	9-5/16	Units less than 72"
	24" File	26-1/2	16-1/16	9-13/16	25-1/2	15-1/16	9-5/16	Workstation Credenzas less than 82"
31" Lateral	24" File	28-9/16	16-1/16	9-13/16	27-9/16	15-1/16	9-5/16	Multi-File Lateral File
35" Lateral	24" File	32-1/2	16-1/16	9-13/16	31-1/2	15-1/16	9-5/16	Workstation Credenzas over 83"

Filing Reference

Filing for 24" depth units

13 1/8" Wide File Drawer - 16 1/16" Deep

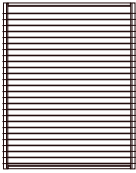

Letter Front to Back

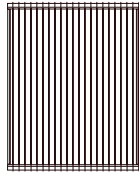

Legal Side to Side with File Rail

29" and 31" Lateral file drawer

26-1/2" Wide File Drawer - 16-1/16" Deep

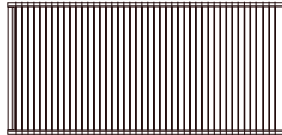

Legal Side to Side

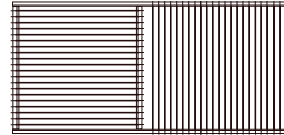

Legal Side to Side Letter Front to Back with File Rail

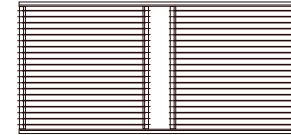

Letter Front to Back with File Rail

Filing for 30" & 36" depth units

13 1/8" Wide File Drawer - 19 11/16" Deep

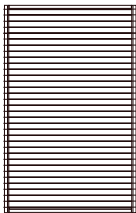

Letter Front to Back

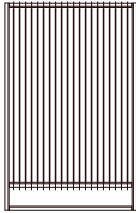

Legal Side to Side with File Rail

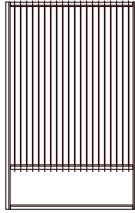

Letter Side to Side with File Rail

35" Lateral file drawer

32-1/2" Wide File Drawer - 16-1/16" Deep

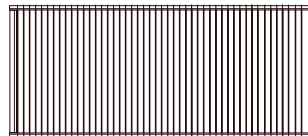

Legal Side to Side

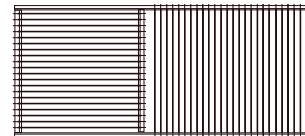

Legal Side to Side Letter Front to Back with File Rail

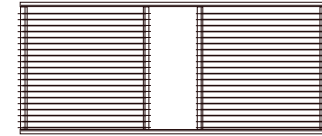

Letter Front to Back with File Rail

WOOD FINISHES



WGW Gunstock Walnut



WHC Honey Cherry



WAC Amber Cherry



WNW Natural Walnut

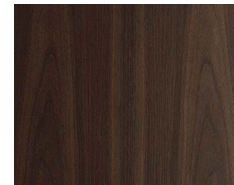

WSW Smokey Walnut



WBW Henna Walnut



WEW Executive Walnut

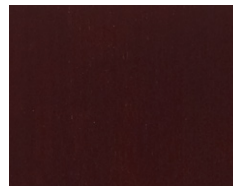

WIC Crimson Cherry

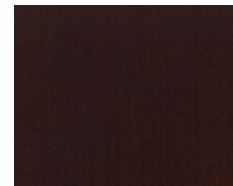

WOC KoKo Cherry

HIGH PRESSURE LAMINATES



GHC Honey Cherry



GAC Amber Cherry



GNW Natural Walnut



GEW Executive Walnut



GIC Crimson Cherry

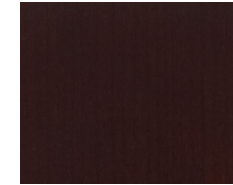

GOC KoKo Cherry



Finish

Welltech Finish delivers a superior furniture coating with exceptional performance that can withstand stringent cleaning agents and possesses unparalleled durability, allowing DARRAN to provide lasting, sustainable products to our customers.

Capitol Park

Double Pedestal Desks
Executive / Breakfront

[Click here to view statement of line](#)

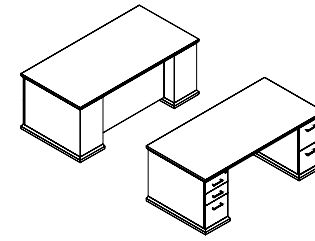

1 Select Model

w" x d" x h"	Weight
84 x 36 x 29	350
78 x 36 x 29	335
72 x 36 x 29	315
72 x 30 x 29	295
66 x 30 x 29	270
60 x 30 x 29	260

Standard Veneer Top Standard Veneer Chassis	Premium Veneer Top Premium Veneer Chassis	High Pressure Laminate Top Veneer Chassis	Thermally Fused Laminate Top Thermally Fused Laminate Chassis
CAP8436DD000W 5457	"P" Option N/A	CAP8436DD000G 5457	"M" Option N/A
CAP7836DD000W 5276	"P" Option N/A	CAP7836DD000G 5276	"M" Option N/A
CAP7236DD000W 5094	"P" Option N/A	CAP7236DD000G 5094	"M" Option N/A
CAP7230DD000W 4914	"P" Option N/A	CAP7230DD000G 4914	"M" Option N/A
CAP6630DD000W 4761	"P" Option N/A	CAP6630DD000G 4761	"M" Option N/A
CAP6030DD000W 4470	"P" Option N/A	CAP6030DD000G 4470	"M" Option N/A

Product Features

- Box/Box/File- Left
- File/File - Right
- Full extension drawers - locking
- Hardwood base w/ mitred corners
- Legal/Letter Filing
- Soft close suspension drawer(s)

Notes

- 6" Recessed Modesty

Options

Accessories

- K28: Articulating keyboard w/ mouse pad - \$390
- K31: Center drawer - \$205
- PC10: Desk pedestal w/ wire cavity and access door - \$100

Drawer

- P6: Modify File/File to Box/Box/File - \$55
- P33: Wood Drawer Upgrade - \$45 per drawer

Grommets (Standard Location)

Specify Color and Left/Right - \$50 ea.

- Black: TM30-R (Right), TM30-L (Left)
- Silver: TM31-R (Right), TM31-L (Left)
- Antique Brass: TM33-R (Right), TM33-L (Left)

Grommets (Non-Standard Location)

Provide drawing w/ Grommet Location and Specify Color - \$95 ea.

- Black: TM30-NS
- Silver: TM31-NS
- Antique Brass: TM33-NS

Modesty

- M11: Breakfront Arch Modesty - \$205

2 Select Finish

[Click to view Veneer Finishes](#)

[Click to view High Pressure Laminates](#)

3 Select Edge

[Click to view edges](#)



4 Select Hardware

[Click to view details](#)

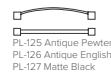
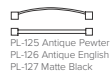

Double Pedestal Desks
Bowfront / Breakfront

[Click here to view statement of line](#)

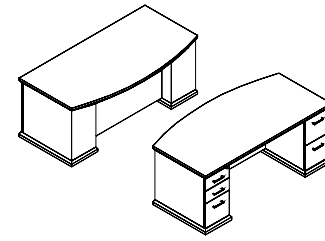

1 Select Model

w" x d" x h"	Weight
84 x 42 x 29	375
78 x 36/42 x 29	360
72 x 36/42 x 29	335
72 x 30/36 x 29	315
66 x 30/36 x 29	300

Standard Veneer Top Standard Veneer Chassis	Premium Veneer Top Premium Veneer Chassis	High Pressure Laminate Top Veneer Chassis	Thermally Fused Laminate Top Thermally Fused Laminate Chassis
CAP8442DD006W 6329	"P" Option N/A	CAP8442DD006G 6329	"M" Option N/A
CAP7842DD006W 5930	"P" Option N/A	CAP7842DD006G 5930	"M" Option N/A
CAP7242DD006W 5513	"P" Option N/A	CAP7242DD006G 5513	"M" Option N/A
CAP7236DD006W 5298	"P" Option N/A	CAP7236DD006G 5298	"M" Option N/A
CAP6636DD006W 5201	"P" Option N/A	CAP6636DD006G 5201	"M" Option N/A

Product Features

- Box/Box/File (left)
- File/File - Right
- Full extension drawers - locking
- Hardwood base w/ mitred corners
- Legal/Letter Filing
- Soft close suspension drawer(s)

Notes

- 12" Recessed Modesty

Options

Accessories

- K28: Articulating keyboard w/ mouse pad - \$390
- K31: Center drawer - \$205
- PC10: Desk pedestal w/ wire cavity and access door - \$100

Drawer

- P6: Modify File/File to Box/Box/File - \$55
- P33: Wood Drawer Upgrade - \$45 per drawer

Grommets (Standard Location)

- Specify Color and Left/Right - \$50 ea.
- Black: TM30-R (Right), TM30-L (Left)
 - Silver: TM31-R (Right), TM31-L (Left)
 - Antique Brass: TM33-R (Right), TM33-L (Left)

Grommets (Non-Standard Location)

- Provide drawing w/ Grommet Location and Specify Color - \$95 ea.
- Black: TM30-NS
 - Silver: TM31-NS
 - Antique Brass: TM33-NS

Modesty

- M11: Breakfront Arch Modesty - \$205

2 Select Finish

[Click to view Veneer Finishes](#)

[Click to view High Pressure Laminates](#)

3 Select Edge

[Click to view edges](#)



4 Select Hardware

[Click to view details](#)

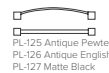
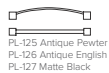

Capitol Park

Workstation Desks
Breakfront - Single Pedestal

[Click here to view statement of line](#)

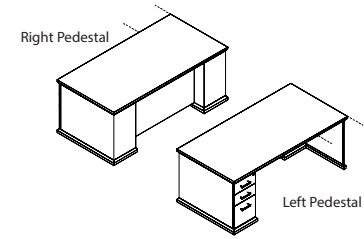

1 Select Model

w" x d" x h"
Left Pedestal
72 x 36 x 29
72 x 30 x 29
66 x 30 x 29
Right Pedestal
72 x 36 x 29
72 x 30 x 29
66 x 30 x 29

Weight	Standard Veneer Top Standard Veneer Chassis	Premium Veneer Top Premium Veneer Chassis	High Pressure Laminate Top Veneer Chassis	Thermally Fused Laminate Top Thermally Fused Laminate Chassis
275	CAP7236DS009W 4561	"P" Option N/A	CAP7236DS009G 4561	"M" Option N/A
255	CAP7230DS009W 4413	"P" Option N/A	CAP7230DS009G 4413	"M" Option N/A
225	CAP6630DS009W 4315	"P" Option N/A	CAP6630DS009G 4315	"M" Option N/A
275	CAP7236DS010W 4561	"P" Option N/A	CAP7236DS010G 4561	"M" Option N/A
255	CAP7230DS010W 4413	"P" Option N/A	CAP7230DS010G 4413	"M" Option N/A
225	CAP6630DS010W 4315	"P" Option N/A	CAP6630DS010G 4315	"M" Option N/A

Product Features

- Box/Box/File
- Full extension drawers - locking
- Hardwood base w/ mitred corners
- Hookup hardware
- Legal/Letter Filing
- Soft close suspension drawer(s)

Notes

- 6" Recessed Modesty

Options

Accessories

- K28: Articulating keyboard w/ mouse pad - \$390
- K31: Center drawer - \$205
- PC10: Desk pedestal w/ wire cavity and access door - \$100

Drawer

- P33: Wood Drawer Upgrade - \$45 per drawer

Grommets (Standard Location)

Specify Color and Left/Right - \$50 ea.

- Black: TM30-R (Right), TM30-L (Left)
- Silver: TM31-R (Right), TM31-L (Left)
- Antique Brass: TM33-R (Right), TM33-L (Left)

Grommets (Non-Standard Location)

Provide drawing w/ Grommet Location and Specify Color - \$95 ea.

- Black: TM30-NS
- Silver: TM31-NS
- Antique Brass: TM33-NS

Modesty

- M11: Breakfront Arch Modesty - \$205

2 Select Finish

[Click to view
Veneer Finishes](#)

[Click to view
High Pressure Laminates](#)

3 Select Edge

[Click to view edges](#)



4 Select Hardware

[Click to view details](#)

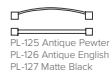

Capitol Park

Workstation Desks
Bowfront Breakfront - Single Pedestal

[Click here to view statement of line](#)

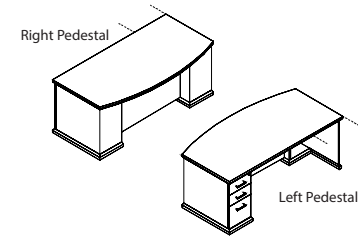

1 Select Model

w" x d" x h"	Weight
Left Pedestal	
72 x 36/42 x 29	280
72 x 30/36 x 29	260
66 x 30/36 x 29	230
Right Pedestal	
72 x 36/42 x 29	280
72 x 30/36 x 29	260
66 x 30/36 x 29	230

	Standard Veneer Top Standard Veneer Chassis	Premium Veneer Top Premium Veneer Chassis	High Pressure Laminate Top Veneer Chassis	Thermally Fused Laminate Top Thermally Fused Laminate Chassis
Click to view Veneer Finishes			Click to view High Pressure Laminates	
Click to view edges			Capitol	
Click to view details				

2 Select Finish

3 Select Edge

Click to view edges



4 Select Hardware

Click to view details

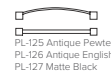

Product Features

- Box/Box/File
- Full extension drawers - locking
- Hardwood base w/ mitred corners
- Hookup hardware
- Legal/Letter Filing
- Soft close suspension drawer(s)

Notes

- 12" Recessed Modesty

Options

Accessories

- K28: Articulating keyboard w/ mouse pad - \$390
- K31: Center drawer - \$205
- PC10: Desk pedestal w/ wire cavity and access door - \$100

Drawer

- P33: Wood Drawer Upgrade - \$45 per drawer

Grommets (Standard Location)

Specify Color and Left/Right - \$50 ea.

- Black: TM30-R (Right), TM30-L (Left)
- Silver: TM31-R (Right), TM31-L (Left)
- Antique Brass: TM33-R (Right), TM33-L (Left)

Grommets (Non-Standard Location)

Provide drawing w/ Grommet Location and Specify Color - \$95 ea.

- Black: TM30-NS
- Silver: TM31-NS
- Antique Brass: TM33-NS

Modesty

- M11: Breakfront Arch Modesty - \$205

Capitol Park

Workstation Desks
Conference Overhang Breakfront - Single Pedestal

[Click here to view statement of line](#)

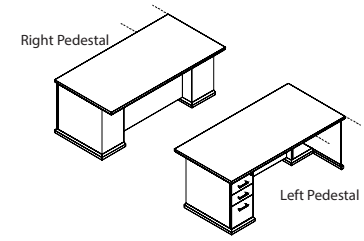

1 Select Model

w" x d" x h"
Left Pedestal
72 x 36 x 29
66 x 36 x 29
Right Pedestal
72 x 36 x 29
66 x 36 x 29

Weight	Standard Veneer Top Standard Veneer Chassis	Premium Veneer Top Premium Veneer Chassis	High Pressure Laminate Top Veneer Chassis	Thermally Fused Laminate Top Thermally Fused Laminate Chassis
255	CAP7236DS634W 4376	"P" Option N/A	CAP7236DS634G 4376	"M" Option N/A
245	CAP6636DS634W 4194	"P" Option N/A	CAP6636DS634G 4194	"M" Option N/A
255	CAP7236DS633W 4376	"P" Option N/A	CAP7236DS633G 4376	"M" Option N/A
245	CAP6636DS633W 4194	"P" Option N/A	CAP6636DS633G 4194	"M" Option N/A

Product Features

- Box/Box/File
- Full extension drawers - locking
- Hardwood base w/ mitred corners
- Hookup hardware
- Legal/Letter Filing
- Soft close suspension drawer(s)

Notes

- 12" Recessed Modesty
- 66" wide unit - 66 x 30 Chassis
- 72" wide unit - 72 x 30 Chassis

Options

Accessories

- K28: Articulating keyboard w/ mouse pad - \$390
- K31: Center drawer - \$205
- PC10: Desk pedestal w/ wire cavity and access door - \$100

Drawer

- P33: Wood Drawer Upgrade - \$45 per drawer

Grommets (Standard Location)

Specify Color and Left/Right - \$50 ea.

- Black: TM30-R (Right), TM30-L (Left)
- Silver: TM31-R (Right), TM31-L (Left)
- Antique Brass: TM33-R (Right), TM33-L (Left)

Grommets (Non-Standard Location)

Provide drawing w/ Grommet Location and Specify Color - \$95 ea.

- Black: TM30-NS
- Silver: TM31-NS
- Antique Brass: TM33-NS

Modesty

- M11: Breakfront Arch Modesty - \$205

2 Select Finish

[Click to view
Veneer Finishes](#)

[Click to view
High Pressure Laminates](#)

3 Select Edge

[Click to view edges](#)



4 Select Hardware

[Click to view details](#)

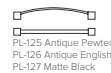
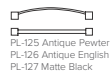

Capitol Park

"L" Workstation Returns
File/File

[Click here to view statement of line](#)

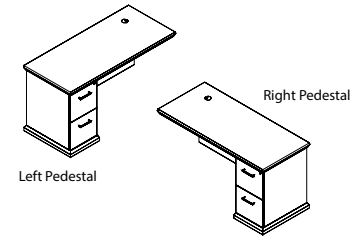

1 Select Model

w" x d" x h"	Weight
66 x 24 x 29	175
60 x 24 x 29	165
54 x 24 x 29	155
48 x 24 x 29	145
42 x 24 x 29	135
Right Pedestal	
66 x 24 x 29	175
60 x 24 x 29	165
54 x 24 x 29	155
48 x 24 x 29	145
42 x 24 x 29	135

Standard Veneer Top Standard Veneer Chassis	Premium Veneer Top Premium Veneer Chassis	High Pressure Laminate Top Veneer Chassis	Thermally Fused Laminate Top Thermally Fused Laminate Chassis
CAP6624RE195W 3510	"P" Option N/A	CAP6624RE195G 3510	"M" Option N/A
CAP6024RE195W 3413	"P" Option N/A	CAP6024RE195G 3413	"M" Option N/A
CAP5424RE195W 3327	"P" Option N/A	CAP5424RE195G 3327	"M" Option N/A
CAP4824RE195W 3232	"P" Option N/A	CAP4824RE195G 3232	"M" Option N/A
CAP4224RE195W 3146	"P" Option N/A	CAP4224RE195G 3146	"M" Option N/A
Right Pedestal			
CAP6624RE196W 3510	"P" Option N/A	CAP6624RE196G 3510	"M" Option N/A
CAP6024RE196W 3413	"P" Option N/A	CAP6024RE196G 3413	"M" Option N/A
CAP5424RE196W 3327	"P" Option N/A	CAP5424RE196G 3327	"M" Option N/A
CAP4824RE196W 3232	"P" Option N/A	CAP4824RE196G 3232	"M" Option N/A
CAP4224RE196W 3146	"P" Option N/A	CAP4224RE196G 3146	"M" Option N/A

Product Features

- 1 Standard grommet - matches pull finish or specify black TM30, silver TM31 or antique brass TM33
- Fixed full modesty
- Full extension drawers - locking
- Hardwood base w/ mitred corners
- Hookup hardware
- Soft close suspension drawer(s)

Options

Accessories

- K28: Articulating keyboard w/ mouse pad - \$390

Drawer

- P6: Modify File/File to Box/Box/File - \$55
- P33: Wood Drawer Upgrade - \$45 per drawer

Flush Cut

- FC-L: Flush Unit Left (Facing) for Ganging - \$100
- FC-R: Flush Unit Right(Facing) for Ganging - \$100

Grommets (Non-Standard Location)

Provide drawing w/ Grommet Location and Specify Color - \$95 ea.

- Black: TM30-NS
- Silver: TM31-NS
- Antique Brass: TM33-NS

Modesty

- M34T: Drop Door Tech Modesty - \$130
- M51: Open Back Modesty with Wire Mgmt Rail - Deduct \$95

2 Select Finish

[Click to view Veneer Finishes](#)

[Click to view High Pressure Laminates](#)

3 Select Edge

[Click to view edges](#)



4 Select Hardware

[Click to view details](#)

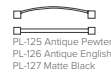
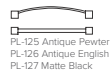

Capitol Park

"L" Workstation Returns
Lateral File

[Click here to view statement of line](#)

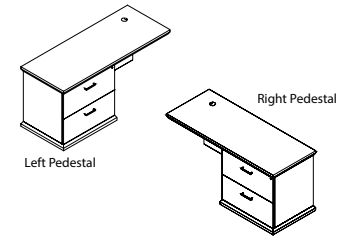

1 Select Model

w" x d" x h"	Weight
72 x 24 x 29	200
66 x 24 x 29	190
60 x 24 x 29	185
54 x 24 x 29	180
48 x 24 x 29	175
Right Pedestal	
72 x 24 x 29	200
66 x 24 x 29	190
60 x 24 x 29	185
54 x 24 x 29	180
48 x 24 x 29	175

Standard Veneer Top Standard Veneer Chassis	Premium Veneer Top Premium Veneer Chassis	High Pressure Laminate Top Veneer Chassis	Thermally Fused Laminate Top Thermally Fused Laminate Chassis
CAP7224RE187W 4058	"P" Option N/A	CAP7224RE187G 4058	"M" Option N/A
CAP6624RE187W 3874	"P" Option N/A	CAP6624RE187G 3874	"M" Option N/A
CAP6024RE187W 3780	"P" Option N/A	CAP6024RE187G 3780	"M" Option N/A
CAP5424RE187W 3692	"P" Option N/A	CAP5424RE187G 3692	"M" Option N/A
CAP4824RE187W 3596	"P" Option N/A	CAP4824RE187G 3596	"M" Option N/A
Right Pedestal			
CAP7224RE188W 4058	"P" Option N/A	CAP7224RE188G 4058	"M" Option N/A
CAP6624RE188W 3874	"P" Option N/A	CAP6624RE188G 3874	"M" Option N/A
CAP6024RE188W 3780	"P" Option N/A	CAP6024RE188G 3780	"M" Option N/A
CAP5424RE188W 3692	"P" Option N/A	CAP5424RE188G 3692	"M" Option N/A
CAP4824RE188W 3596	"P" Option N/A	CAP4824RE188G 3596	"M" Option N/A

2 Select Finish

[Click to view Veneer Finishes](#)

[Click to view High Pressure Laminates](#)

3 Select Edge

[Click to view edges](#)



4 Select Hardware

[Click to view details](#)

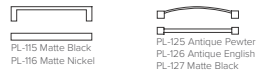

Product Features

- 1 Standard grommet - matches pull finish or specify black TM30, silver TM31 or antique brass TM33
- Fixed full modesty
- Hardwood base w/ mitred corners
- Hookup hardware
- Features ball bearing suspensions, suspensions are full extension.

Notes

- K28 Keyboards not available on 48" units

Options

Accessories

- K28: Articulating keyboard w/ mouse pad - \$390

Drawer

- P33: Wood Drawer Upgrade - \$45 per drawer

Flush Cut

- FC-L: Flush Unit Left (Facing) for Ganging - \$100
- FC-R: Flush Unit Right(Facing) for Ganging - \$100

Grommets (Non-Standard Location)

Provide drawing w/ Grommet Location and Specify Color - \$95 ea.

- Black: TM30-NS
- Silver: TM31-NS
- Antique Brass: TM33-NS

Modesty

- M34T: Drop Door Tech Modesty - \$130
- M51: Open Back Modesty with Wire Mgmt Rail - Deduct \$95

Capitol Park

"L" Workstation Returns
Box/Box/File/Lateral

[Click here to view statement of line](#)

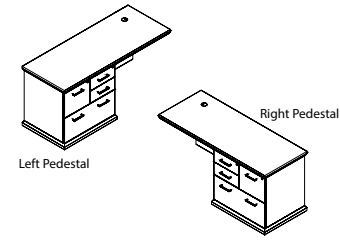

1 Select Model

w" x d" x h"	Weight
Left Pedestal	
72 x 24 x 29	225
66 x 24 x 29	190
60 x 24 x 29	185
54 x 24 x 29	180
48 x 24 x 29	175
Right Pedestal	
72 x 24 x 29	225
66 x 24 x 29	190
60 x 24 x 29	185
54 x 24 x 29	180
48 x 24 x 29	175

Standard Veneer Top Standard Veneer Chassis	Premium Veneer Top Premium Veneer Chassis	High Pressure Laminate Top Veneer Chassis	Thermally Fused Laminate Top Thermally Fused Laminate Chassis
CAP7224RE218W 4420	"P" Option N/A	CAP7224RE218G 4420	"M" Option N/A
CAP6624RE218W 4238	"P" Option N/A	CAP6624RE218G 4238	"M" Option N/A
CAP6024RE218W 4141	"P" Option N/A	CAP6024RE218G 4141	"M" Option N/A
CAP5424RE218W 4058	"P" Option N/A	CAP5424RE218G 4058	"M" Option N/A
CAP4824RE218W 3961	"P" Option N/A	CAP4824RE218G 3961	"M" Option N/A
CAP7224RE219W 4420	"P" Option N/A	CAP7224RE219G 4420	"M" Option N/A
CAP6624RE219W 4238	"P" Option N/A	CAP6624RE219G 4238	"M" Option N/A
CAP6024RE219W 4141	"P" Option N/A	CAP6024RE219G 4141	"M" Option N/A
CAP5424RE219W 4058	"P" Option N/A	CAP5424RE219G 4058	"M" Option N/A
CAP4824RE219W 3961	"P" Option N/A	CAP4824RE219G 3961	"M" Option N/A

2 Select Finish

[Click to view Veneer Finishes](#)

[Click to view High Pressure Laminates](#)

3 Select Edge

[Click to view edges](#)



4 Select Hardware

[Click to view details](#)

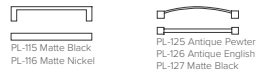

Product Features

- 1 Standard grommet - matches pull finish or specify black TM30, silver TM31 or antique brass TM33
- Fixed full modesty
- iWi & iGi Box and File Drawers feature soft close suspensions (Lateral Drawers Feature ball bearing suspensions), suspensions are full extension.
- Hardwood base w/ mitred corners
- Hookup hardware
- Soft close suspension drawer(s)

Notes

- K28 Keyboards not available on 48" units

Options

Accessories

- K28: Articulating keyboard w/ mouse pad - \$390

Drawer

- P33: Wood Drawer Upgrade - \$45 per drawer

Flush Cut

- FC-L: Flush Unit Left (Facing) for Ganging - \$100
- FC-R: Flush Unit Right(Facing) for Ganging - \$100

Grommets (Non-Standard Location)

Provide drawing w/ Grommet Location and Specify Color - \$95 ea.

- Black: TM30-NS
- Silver: TM31-NS
- Antique Brass: TM33-NS

Modesty

- M34T: Drop Door Tech Modesty - \$130
- M5t: Open Back Modesty with Wire Mgmt Rail - Deduct \$95

Capitol Park

Workstation Bridges
Open Back

[Click here to view statement of line](#)

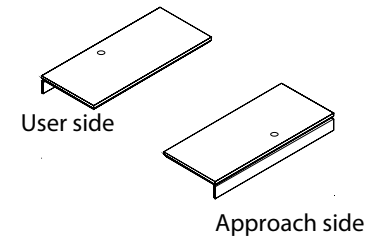

1 Select Model

w" x d" x h"	Weight
48 x 24 x 29	55
42 x 24 x 29	50
36 x 24 x 29	45

Standard Veneer Top Standard Veneer Chassis	Premium Veneer Top Premium Veneer Chassis	High Pressure Laminate Top Veneer Chassis	Thermally Fused Laminate Top Thermally Fused Laminate Chassis												
<table border="1"> <tr> <td>CAP4824BR151W</td> <td>1016</td> </tr> <tr> <td>CAP4224BR151W</td> <td>965</td> </tr> <tr> <td>CAP3624BR151W</td> <td>915</td> </tr> </table>	CAP4824BR151W	1016	CAP4224BR151W	965	CAP3624BR151W	915	<p>"P" Option N/A "P" Option N/A "P" Option N/A</p>	<table border="1"> <tr> <td>CAP4824BR151G</td> <td>1016</td> </tr> <tr> <td>CAP4224BR151G</td> <td>965</td> </tr> <tr> <td>CAP3624BR151G</td> <td>915</td> </tr> </table>	CAP4824BR151G	1016	CAP4224BR151G	965	CAP3624BR151G	915	<p>"M" Option N/A "M" Option N/A "M" Option N/A</p>
CAP4824BR151W	1016														
CAP4224BR151W	965														
CAP3624BR151W	915														
CAP4824BR151G	1016														
CAP4224BR151G	965														
CAP3624BR151G	915														

2 Select Finish

[Click to view Veneer Finishes](#)

[Click to view High Pressure Laminates](#)

3 Select Edge

[Click to view edges](#)



4 Select Hardware

[Click to view details](#)



Product Features

- 1 Standard grommet - matches pull finish or specify black TM30, silver TM31 or antique brass TM33

Options

Accessories

- K28: Articulating keyboard w/ mouse pad - \$390

Grommets (Non-Standard Location)

Provide drawing w/ Grommet Location and Specify Color - \$95 ea.

- Black: TM30-NS

- Silver: TM31-NS

- Antique Brass: TM33-NS

Modesty

- M34T-O: Drop Door Tech Modesty - \$295

- M37: Fixed Full Modesty - \$130

Capitol Park

Credenzas
File / Storage

[Click here to view statement of line](#)

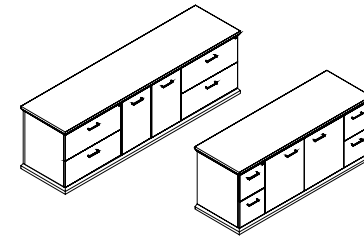

1 Select Model

w" x d" x h"	Weight
Lateral File / Storage	
94 x 24 x 29	350
88 x 24 x 29	320
File / Storage	
71 x 24 x 29	270
65 x 24 x 29	255
59 x 24 x 29	240

	Standard Veneer Top Standard Veneer Chassis	Premium Veneer Top Premium Veneer Chassis	High Pressure Laminate Top Veneer Chassis	Thermally Fused Laminate Top Thermally Fused Laminate Chassis
		"P" Option N/A		"M" Option N/A
		"P" Option N/A		"M" Option N/A
		"P" Option N/A		"M" Option N/A
		"P" Option N/A		"M" Option N/A
		"P" Option N/A		"M" Option N/A
		"P" Option N/A		"M" Option N/A
		"P" Option N/A		"M" Option N/A
		"P" Option N/A		"M" Option N/A

2 Select Finish

[Click to view Veneer Finishes](#)

[Click to view High Pressure Laminates](#)

3 Select Edge

[Click to view edges](#)



4 Select Hardware

[Click to view details](#)

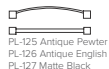

Product Features

- Black laminate adjustable shelf behind doors
- Hardwood base w/ mitred corners
- Top shaped on 3 sides
- iWi & iGi Box and File Drawers feature soft close suspensions (Lateral Drawers Feature ball bearing suspensions). Both suspensions are full extension.

Notes

- Unit has black back panel and is not designed for Open Plan use. Select OPB Option for Open Plan application

Options

Door

- D2: Door Lock - \$100 per door set
- D6A: "W"/"G" Styles - Delete Doors and replace black laminate shelf with finished shelf - n/c
- D9SC: Soft Close Door Hinges - \$20 per door

Drawer

- P6: Modify File/File to Box/Box/File - \$55 ea.
- P33: Wood Drawer Upgrade - \$45 per drawer

Flush Cut

- FC-B: Flush Unit Both Sides(Facing) for Ganging - \$100
- FC-L: Flush Unit Left (Facing) for Ganging - \$100
- FC-R: Flush Unit Right(Facing) for Ganging - \$100

Grommets (Standard Location)

- Specify Color and Left/Right/Center - \$50 ea.
- Black: TM30-R (Right), TM30-L (Left), TM30-C (Center)
 - Silver: TM31-R (Right), TM31-L (Left), TM31-C (Center)
 - Antique Brass: TM33-R (Right), TM33-L (Left), TM33-C (Center)

Grommets (Non-Standard Location)

- Provide drawing w/ Grommet Location and Specify Color - \$95 ea.
- Black: TM30-NS
 - Silver: TM31-NS
 - Antique Brass: TM33-NS

Open Plan _ Finished Back

- OPB: Modify Unit for Open Plan Application - \$295

Shelves

- S25: Replace Black Laminate Shelves with Finished Shelves - \$80 per shelf

Capitol Park

Credenzas
Kneespace

[Click here to view statement of line](#)

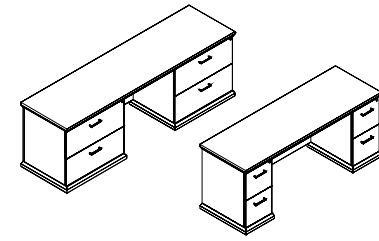

1 Select Model

w" x d" x h"	Weight
Lateral File / Lateral File	
94 x 24 x 29	325
88 x 24 x 29	300
File / File	
78 x 24 x 29	250
71 x 24 x 29	225
65 x 24 x 29	210
59 x 24 x 29	200

Standard Veneer Top Standard Veneer Chassis	Premium Veneer Top Premium Veneer Chassis	High Pressure Laminate Top Veneer Chassis	Thermally Fused Laminate Top Thermally Fused Laminate Chassis
CAP9424CA052W 6288	"P" Option N/A	CAP9424CA052G 6288	"M" Option N/A
CAP8824CA052W 5923	"P" Option N/A	CAP8824CA052G 5923	"M" Option N/A
CAP7824CA054W 4830	"P" Option N/A	CAP7824CA054G 4830	"M" Option N/A
CAP7124CA054W 4646	"P" Option N/A	CAP7124CA054G 4646	"M" Option N/A
CAP6524CA054W 4376	"P" Option N/A	CAP6524CA054G 4376	"M" Option N/A
CAP5924CA054W 4281	"P" Option N/A	CAP5924CA054G 4281	"M" Option N/A

Product Features

- Fixed full modesty
- Hardwood base w/ mitred corners
- iWi & iGi Box and File Drawers feature soft close suspensions (Lateral Drawers Feature ball bearing suspensions). Both suspensions are full extension.
- Top shaped on 3 sides

Notes

- Unit has black back panel and is not designed for Open Plan use. Select OPB Option for Open Plan application

Options

Accessories

- K28: Articulating keyboard w/ mouse pad - \$390

Drawer

- P6: Modify File/File to Box/Box/File - \$55 ea.
- P33: Wood Drawer Upgrade - \$45 per drawer

Flush Cut

- FC-B: Flush Unit Both Sides(Facing) for Ganging - \$100
- FC-L: Flush Unit Left (Facing) for Ganging - \$100
- FC-R: Flush Unit Right(Facing) for Ganging - \$100

Grommets (Standard Location)

- Specify Color - \$50 ea.
- Black: TM30-C (Center)
- Silver: TM31-C (Center)
- Antique Brass: TM33-C (Center)

Grommets (Non-Standard Location)

- Provide drawing w/ Grommet Location and Specify Color - \$95 ea.
- Black: TM30-NS
- Silver: TM31-NS
- Antique Brass: TM33-NS

Modesty

- M34T:Drop Door Tech Modesty - \$130
- M51: Open Back Modesty with Wire Mgmt Rail - Deduct \$95

Open Plan _ Finished Back

- OPB:Modify Unit for Open Plan Application - \$295

2 Select Finish

[Click to view Veneer Finishes](#)

[Click to view High Pressure Laminates](#)

3 Select Edge

[Click to view edges](#)



4 Select Hardware

[Click to view details](#)

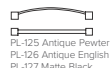

Capitol Park

Credenzas
Storage

[Click here to view statement of line](#)

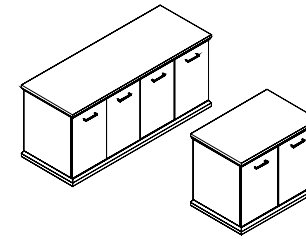

1 Select Model

w" x d" x h"

4 Door	Weight	Standard Veneer Top Standard Veneer Chassis	Premium Veneer Top Premium Veneer Chassis
71 x 24 x 29	250	CAP7124CA125W 4830	"P" Option N/A
65 x 24 x 29	235	CAP6524CA125W 4501	"P" Option N/A
59 x 24 x 29	220	CAP5924CA125W 4315	"P" Option N/A
2 Door			
36 x 24 x 29	140	CAP3624CA125W 2642	"P" Option N/A
30 x 24 x 29	125	CAP3024CA125W 2460	"P" Option N/A

2 Select Finish

[Click to view
Veneer Finishes](#)

[Click to view
High Pressure Laminates](#)

3 Select Edge

[Click to view edges](#)



4 Select Hardware

[Click to view details](#)



Thermally Fused Laminate Top Thermally Fused Laminate Chassis

"M" Option N/A
"M" Option N/A
"M" Option N/A
"M" Option N/A
"M" Option N/A

Product Features

- Adjustable shelf per door section (black laminate)
- Anti-tilt safety feature
- Hardwood base w/ mitred corners
- Top shaped on 3 sides

Notes

- Unit has black back panel and is not designed for Open Plan use. Select OPB Option for Open Plan application

Options

Door

- D2: Door Lock - \$100 per door set
- D6A: "W"/"G" Styles - Delete Doors and replace black laminate shelf with finished shelf - n/c
- D9SC: Soft Close Door Hinges - \$20 per door

Flush Cut

- FC-B: Flush Unit Both Sides(Facing) for Ganging - \$100
- FC-L: Flush Unit Left (Facing) for Ganging - \$100
- FC-R: Flush Unit Right(Facing) for Ganging - \$100

Grommets (Standard Location)

- Specify Color and Left/Right/Center - \$50 ea.
- Black: TM30-R (Right), TM30-L (Left), TM30-C (Center)
 - Silver: TM31-R (Right), TM31-L (Left), TM31-C (Center)
 - Antique Brass: TM33-R (Right), TM33-L (Left), TM33-C (Center)

Open Plan _ Finished Back

- OPB:Modify Unit for Open Plan Application - \$295

Shelves

- S25: Replace Black Laminate Shelves with Finished Shelves - \$80 per shelf

Capitol Park

Lateral File Credenzas
6/4/2 Drawers



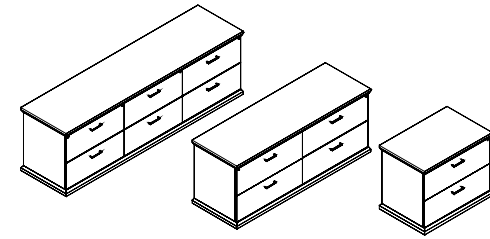

[Click here to view statement of line](#)



1 Select Model

w" x d" x h"

Weight	Model	Weight	Model
6 Drawer			
94 x 24 x 29	415	CAP9424CA104W	8656
88 x 24 x 29	390	CAP8824CA104W	8290
4 Drawer			
71 x 24 x 29	315	CAP7124CA104W	5411
59 x 24 x 29	285	CAP5924CA104W	5230
2 Drawer			
36 x 24 x 29	165	CAP3624CA104W	2832
30 x 24 x 29	150	CAP3024CA104W	2685

Standard Veneer Top Standard Veneer Chassis	Premium Veneer Top Premium Veneer Chassis	High Pressure Laminate Top Veneer Chassis	Thermally Fused Laminate Top Thermally Fused Laminate Chassis
<p>Click to view Veneer Finishes</p>		<p>Click to view High Pressure Laminates</p>	
<p>Click to view edges</p> 		<p>Click to view edges</p> 	
<p>Click to view details</p> 		<p>Click to view details</p> 	

Product Features

- Full extension drawers - locking
- Hardwood base w/ mitred corners
- Features ball bearing suspensions, suspensions are full extension
- Top shaped on 3 sides

Notes

- Unit has black back panel and is not designed for Open Plan use. Select OPB Option for Open Plan application

Options

Drawer

- P33: Wood Drawer Upgrade - \$45 per drawer

Flush Cut

- FC-B: Flush Unit Both Sides(Facing) for Ganging - \$100
- FC-L: Flush Unit Left (Facing) for Ganging - \$100
- FC-R: Flush Unit Right(Facing) for Ganging - \$100

Open Plan _ Finished Back

- OPB:Modify Unit for Open Plan Application - \$295

Capitol Park

Lateral File
Vertical Lateral File

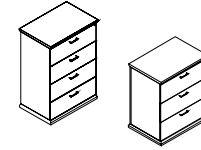

[Click here to view statement of line](#)

1 Select Model

w" x d" x h"

Weight	Standard Veneer Top Standard Veneer Chassis	Premium Veneer Top Premium Veneer Chassis	High Pressure Laminate Top Veneer Chassis	Thermally Fused Laminate Top Thermally Fused Laminate Chassis
4 Drawer				
36 x 24 x 52	270	CAP3624FI111W 4681	"P" Option N/A	CAP3624FI111G 4681
30 x 24 x 52	245	CAP3024FI111W 4561	"P" Option N/A	CAP3024FI111G 4561
3 Drawer				
36 x 24 x 42	205	CAP3624FI112W 4083	"P" Option N/A	CAP3624FI112G 4083
30 x 24 x 42	185	CAP3024FI112W 3975	"P" Option N/A	CAP3024FI112G 3975

2 Select Finish

[Click to view Veneer Finishes](#)

[Click to view High Pressure Laminates](#)

3 Select Edge

[Click to view edges](#)



4 Select Hardware

[Click to view details](#)



Product Features

- Anti-tilt safety feature
- Hardwood base w/ mitred corners
- Features ball bearing suspensions, suspensions are full extension
- Top shaped on 3 sides

Notes

- Unit has black back panel and is not designed for Open Plan use. Select OPB Option for Open Plan application

Options

Drawer

- P33: Wood Drawer Upgrade - \$45 per drawer

Flush Cut

- FC-B: Flush Unit Both Sides(Facing) for Ganging - \$100
- FC-L: Flush Unit Left (Facing) for Ganging - \$100
- FC-R: Flush Unit Right(Facing) for Ganging - \$100

Open Plan _ Finished Back

- OPB:Modify Unit for Open Plan Application - \$295

Capitol Park



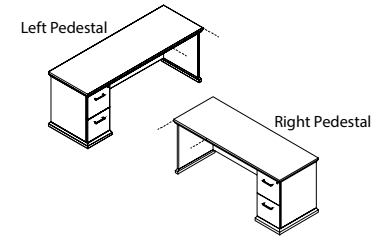

Workstation Credenzas
File/File

[Click here to view statement of line](#)



1 Select Model

w" x d" x h"	Weight
Left Pedestal	
88 x 24 x 29	200
71 x 24 x 29	175
65 x 24 x 29	165
59 x 24 x 29	155
Right Pedestal	
88 x 24 x 29	200
71 x 24 x 29	175
65 x 24 x 29	165
59 x 24 x 29	155

	Standard Veneer Top Standard Veneer Chassis	Premium Veneer Top Premium Veneer Chassis	High Pressure Laminate Top Veneer Chassis	Thermally Fused Laminate Top Thermally Fused Laminate Chassis
Click to view Veneer Finishes			Click to view High Pressure Laminates	
3 Select Edge Click to view edges 				
4 Select Hardware Click to view details 				

Product Features

- Fixed full modesty
- Full extension drawers - locking
- Hookup hardware
- Soft close suspension drawer(s)

Notes

- Unit has black back panel and is not designed for Open Plan use. Select OPB Option for Open Plan application

Options

Accessories

- K28: Articulating keyboard w/ mouse pad - \$390

Drawer

- P6: Modify File/File to Box/Box/File - \$55
- P33: Wood Drawer Upgrade - \$45 per drawer

Flush Cut

- FC-L: Flush Unit Left (Facing) for Ganging - \$100
- FC-R: Flush Unit Right(Facing) for Ganging - \$100

Grommets (Standard Location)

- Specify Color - \$50 ea.
- Black: TM30-C (Center)
 - Silver: TM31-C (Center)
 - Antique Brass: TM33-C (Center)

Grommets (Non-Standard Location)

- Provide drawing w/ Grommet Location and Specify Color - \$95 ea.
- Black: TM30-NS
 - Silver: TM31-NS
 - Antique Brass: TM33-NS

Modesty

- M34T: Drop Door Tech Modesty - \$130
- M51: Open Back Modesty with Wire Mgmt Rail - Deduct \$95

Open Plan _ Finished Back

- OPB: Modify Unit for Open Plan Application - \$295

Capitol Park

Workstation Credenzas
Lateral File

[Click here to view statement of line](#)

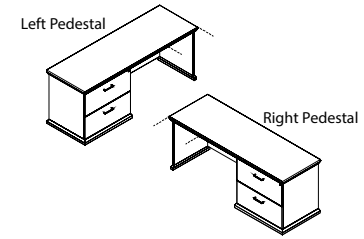

1 Select Model

w" x d" x h"	Weight
Left Pedestal	
94 x 24 x 29	240
88 x 24 x 29	220
71 x 24 x 29	215
65 x 24 x 29	200
59 x 24 x 29	190
Right Pedestal	
94 x 24 x 29	240
88 x 24 x 29	220
71 x 24 x 29	215
65 x 24 x 29	200
59 x 24 x 29	190

	Standard Veneer Top Standard Veneer Chassis	Premium Veneer Top Premium Veneer Chassis	High Pressure Laminate Top Veneer Chassis	Thermally Fused Laminate Top Thermally Fused Laminate Chassis
Click to view Veneer Finishes			Click to view High Pressure Laminates	
Click to view edges			Capitol	
Click to view details	<p>PL-115 Matte Black PL-116 Matte Nickel</p>	<p>PL-125 Antique Pewter PL-126 Antique English PL-127 Matte Black</p>	<p>PL-115 Matte Black PL-116 Matte Nickel</p>	<p>PL-125 Antique Pewter PL-126 Antique English PL-127 Matte Black</p>

Product Features

- Fixed full modesty
- Hookup hardware
- Features ball bearing suspensions, suspensions are full extension

Notes

- K28 Keyboard not available on 71", 65", and 59" units
- Unit has black back panel and is not designed for Open Plan use. Select OPB Option for Open Plan application

Options

Accessories

- K28: Articulating keyboard w/ mouse pad - \$390

Drawer

- P33: Wood Drawer Upgrade - \$45 per drawer

Flush Cut

- FC-L: Flush Unit Left (Facing) for Ganging - \$100
- FC-R: Flush Unit Right(Facing) for Ganging - \$100

Grommets (Standard Location)

Specify Color - \$50 ea.

- Black: TM30-C (Center)
- Silver: TM31-C (Center)
- Antique Brass: TM33-C (Center)

Grommets (Non-Standard Location)

Provide drawing w/ Grommet Location and Specify Color - \$95 ea.

- Black: TM30-NS
- Silver: TM31-NS
- Antique Brass: TM33-NS

Modesty

- M34T: Drop Door Tech Modesty - \$130
- M51: Open Back Modesty with Wire Mgmt Rail - Deduct \$95

Open Plan _ Finished Back

- OPB: Modify Unit for Open Plan Application - \$295

Capitol Park

Workstation Credenzas
Box/Box/File/Lateral

[Click here to view statement of line](#)

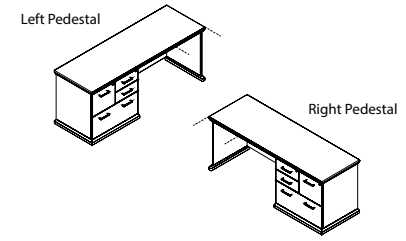

1 Select Model

w" x d" x h"	Weight
Left Pedestal	
94 x 24 x 29	240
88 x 24 x 29	220
71 x 24 x 29	215
65 x 24 x 29	200
59 x 24 x 29	190
Right Pedestal	
94 x 24 x 29	240
88 x 24 x 29	220
71 x 24 x 29	215
65 x 24 x 29	200
59 x 24 x 29	190

Standard Veneer Top Standard Veneer Chassis	Premium Veneer Top Premium Veneer Chassis	High Pressure Laminate Top Veneer Chassis	Thermally Fused Laminate Top Thermally Fused Laminate Chassis
CAP9424CA667W 5194	"P" Option N/A	CAP9424CA667G 5194	"M" Option N/A
CAP8824CA667W 4830	"P" Option N/A	CAP8824CA667G 4830	"M" Option N/A
CAP7124CA667W 4466	"P" Option N/A	CAP7124CA667G 4466	"M" Option N/A
CAP6524CA667W 4376	"P" Option N/A	CAP6524CA667G 4376	"M" Option N/A
CAP5924CA667W 4281	"P" Option N/A	CAP5924CA667G 4281	"M" Option N/A
CAP9424CA668W 5194	"P" Option N/A	CAP9424CA668G 5194	"M" Option N/A
CAP8824CA668W 4830	"P" Option N/A	CAP8824CA668G 4830	"M" Option N/A
CAP7124CA668W 4466	"P" Option N/A	CAP7124CA668G 4466	"M" Option N/A
CAP6524CA668W 4376	"P" Option N/A	CAP6524CA668G 4376	"M" Option N/A
CAP5924CA668W 4281	"P" Option N/A	CAP5924CA668G 4281	"M" Option N/A

Product Features

- Fixed full modesty
- Full extension drawers - locking
- Hookup hardware
- iWi & iGi Box and File Drawers feature soft close suspensions (Lateral Drawers Feature ball bearing suspensions)

Notes

- K28 Keyboard not available on 71", 65", and 59" units
- Unit has black back panel and is not designed for Open Plan use. Select OPB Option for Open Plan application

Options

Accessories

- K28: Articulating keyboard w/ mouse pad - \$390

Drawer

- P33: Wood Drawer Upgrade - \$45 per drawer

Flush Cut

- FC-L: Flush Unit Left (Facing) for Ganging - \$100
- FC-R: Flush Unit Right(Facing) for Ganging - \$100

Grommets (Standard Location)

- Specify Color - \$50 ea.
- Black: TM30-C (Center)
- Silver: TM31-C (Center)
- Antique Brass: TM33-C (Center)

Grommets (Non-Standard Location)

- Provide drawing w/ Grommet Location and Specify Color - \$95 ea.
- Black: TM30-NS
- Silver: TM31-NS
- Antique Brass: TM33-NS

Modesty

- M34T: Drop Door Tech Modesty - \$130
- M51: Open Back Modesty with Wire Mgmt Rail - Deduct \$95

Open Plan _ Finished Back

- OPB: Modify Unit for Open Plan Application - \$295

2 Select Finish

[Click to view Veneer Finishes](#)

[Click to view High Pressure Laminates](#)

3 Select Edge

[Click to view edges](#)



Capitol



Capitol

4 Select Hardware

[Click to view details](#)

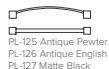

Capitol Park

Single Storage Overhead Console
 Panel Door - 6/4/2 Door

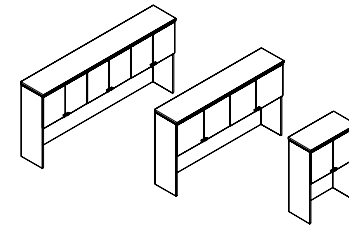

[Click here to view statement of line](#)

1 Select Model

Weight

w" x d" x h"

		Standard Veneer Top Standard Veneer Chassis		Premium Veneer Top Premium Veneer Chassis	High Pressure Laminate Top Veneer Chassis	Thermally Fused Laminate Top Thermally Fused Laminate Chassis
6 Door						
94 x 15 x 43	315	CAP9443OH325W	5172	"P" Option N/A	"G" Option N/A	"M" Option N/A
88 x 15 x 43	285	CAP8843OH325W	4653	"P" Option N/A	"G" Option N/A	"M" Option N/A
4 Door						
84 x 15 x 43	275	CAP8443OH325W	4476	"P" Option N/A	"G" Option N/A	"M" Option N/A
77 x 15 x 43	255	CAP7743OH325W	4304	"P" Option N/A	"G" Option N/A	"M" Option N/A
71 x 15 x 43	240	CAP7143OH325W	3953	"P" Option N/A	"G" Option N/A	"M" Option N/A
65 x 15 x 43	225	CAP6543OH325W	3865	"P" Option N/A	"G" Option N/A	"M" Option N/A
59 x 15 x 43	210	CAP5943OH325W	3781	"P" Option N/A	"G" Option N/A	"M" Option N/A
48 x 15 x 43	105	CAP4843OH325W	3699	"P" Option N/A	"G" Option N/A	"M" Option N/A
2 Door						
36 x 15 x 43	120	CAP3643OH325W	2397	"P" Option N/A	"G" Option N/A	"M" Option N/A
30 x 15 x 43	105	CAP3043OH325W	2362	"P" Option N/A	"G" Option N/A	"M" Option N/A

2 Select Finish

[Click to view
Veneer Finishes](#)

3 Select Edge

[Click to view edges](#)



4 Select Hardware

[Click to view details](#)



DK-125 Antique Pewter
 DK-126 Antique English
 DK-127 Matte Black

Product Features

- Finished front edge
- Interior cabinet depth 12.5"
- 5/8" grommet(s) included for task light wire management
- Top shaped on front and sides

Notes

- Unit has black back panel and is not designed for Open Plan use. Select OPB Option for Open Plan application

Options

Door

- D2: Door Lock - \$100 per door set
- D6: Delete Doors - n/c
- D9SC: Soft Close Door Hinges - \$20 per door

Flush Cut

- FC-B: Flush Unit Both Sides(Facing) for Ganging - \$100
- FC-L: Flush Unit Left (Facing) for Ganging - \$100
- FC-R: Flush Unit Right(Facing) for Ganging - \$100

Grommets (Vertical Surface)

- Standard Location - \$50 ea.
- Black Plastic Vertical Surface: TM50-C (Bottom Center)
- Non-Standard Location - \$95 ea.
- Black Plastic Vertical Surface: TM50-NS

Task Lighting (Recessed)

- Overhead task light cord is located on the right facing side. If the opposite location is required please contact customer service.
- LT-LED24: 24" LED Task light - \$215
- LT-LED48: 48" LED Task light - \$270
- LT-LED60: 60" LED Task light - \$335
- LT-LED72: 72" LED Task light - \$360

Open Plan _ Finished Back

- OPB:Modify Unit for Open Plan Application - \$395

Capitol Park

Single Storage Overhead Console
Wood Frame Door With Clear Glass Inserts

[Click here to view statement of line](#)

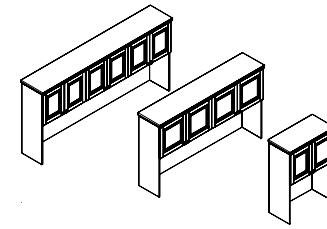

1 Select Model

w" x d" x h"	Weight
6 Door	
94 x 15 x 43	315
88 x 15 x 43	285
4 Door	
71 x 15 x 43	240
65 x 15 x 43	225
59 x 15 x 43	210
2 Door	
36 x 15 x 43	120
30 x 15 x 43	105

Standard Veneer Top Standard Veneer Chassis		Premium Veneer Top Premium Veneer Chassis		High Pressure Laminate Top Veneer Chassis		Thermally Fused Laminate Top Thermally Fused Laminate Chassis	
		"P" Option N/A		"G" Option N/A		"M" Option N/A	
		"P" Option N/A		"G" Option N/A		"M" Option N/A	
		"P" Option N/A		"G" Option N/A		"M" Option N/A	
		"P" Option N/A		"G" Option N/A		"M" Option N/A	
		"P" Option N/A		"G" Option N/A		"M" Option N/A	
		"P" Option N/A		"G" Option N/A		"M" Option N/A	
		"P" Option N/A		"G" Option N/A		"M" Option N/A	

Product Features

- Finished front edge
- Interior cabinet depth 12.5"
- 5/8" grommet(s) included for task light wire management
- Top shaped on front and sides

Notes

- Unit has black back panel and is not designed for Open Plan use. Select OPB Option for Open Plan application

Options

- Door**
- D2-G: Door Lock for Glass Doors - \$205 per door set
 - D9SC: Soft Close Door Hinges - \$20 per door

- Flush Cut**
- FC-B: Flush Unit Both Sides(Facing) for Ganging - \$100
 - FC-L: Flush Unit Left (Facing) for Ganging - \$100
 - FC-R: Flush Unit Right(Facing) for Ganging - \$100

- Grommets (Vertical Surface)**
- Standard Location - \$50 ea.
 - Black Plastic Vertical Surface: TM50-C (Bottom Center)
 - Non-Standard Location - \$95 ea.
 - Black Plastic Vertical Surface: TM50-NS

- Interior Cabinet Lighting**
- LEDPK starter kit includes Infeed, 1 Puck Interior Light and the ability to daisy chain up to 6 total Puck Lights
 - LEDPK: LED Puck Starter Kit - \$310
 - PK: 1 LED Interior Light - \$130

- Task Lighting**
- Overhead task light cord is located on the right facing side. If the opposite location is required please contact customer service.
 - LT-LED24: 24" LED Task light - \$215
 - LT-LED48: 48" LED Task light - \$270
 - LT-LED60: 60" LED Task light - \$335
 - LT-LED72: 72" LED Task light - \$360

- Open Plan _ Finished Back**
- OPB:Modify Unit for Open Plan Application - \$395

2 Select Finish

[Click to view Veneer Finishes](#)

3 Select Edge

[Click to view edges](#)



Capitol

4 Select Hardware

[Click to view details](#)



DK-125 Antique Pewter
DK-126 Antique English
DK-127 Matte Black

DARRAN

Wall hung tackboard Full width tackboards

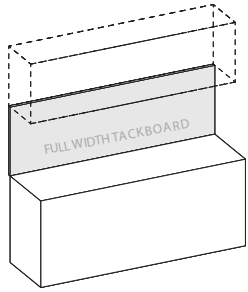

Product Width	Panel Dimension	SKU	COM	1	2	3	4	5	6	7	8	9	10	11/L1	12	13/L2
93	93 x .75 x 24	FTWH9324	465	576	627	678	729	780	831	882	933	984	1035	1086	1137	1239
87	87 x .75 x 24	FTWH8724	448	539	587	635	683	731	779	827	875	923	971	1019	1067	1163
83	83 x .75 x 24	FTWH8324	422	514	560	606	652	698	744	790	836	882	928	974	1020	1112
76	76 x .75 x 24	FTWH7624	388	471	514	557	600	643	686	729	772	815	858	901	944	1030
70	70 x .75 x 24	FTWH7024	355	434	474	514	554	594	634	674	714	754	794	834	874	954
64	64 x .75 x 24	FTWH6424	322	396	432	468	504	540	576	612	648	684	720	756	792	864
58	58 x .75 x 24	FTWH5824	294	359	391	423	455	487	519	551	583	615	647	679	711	775
47	47 x .75 x 24	FTWH4724	236	291	318	345	372	399	426	453	480	507	534	561	588	642
35	35 x .75 x 24	FTWH3524	176	217	237	257	277	297	317	337	357	377	397	417	437	477
29	29 x .75 x 24	FTWH2924	142	179	196	213	230	247	264	281	298	315	332	349	366	400

Standard Features

- Constructed of .875" thick fiberboard
- Fabric is precisely aligned and fitted to the tackboard
- Adhered to the rigid hardboard with staples
- Hung with Z-Strip mounting system

Wall hung tackboard Half width tackboards

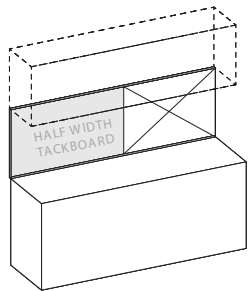

Product Width	Panel Dimension	SKU	COM	1	2	3	4	5	6	7	8	9	10	11/L1	12	13/L2
93 Half Width	46.5 x .75 x 24	FTWH4624	233	288	313	338	363	388	413	438	463	488	513	538	563	613
87 Half Width	43.5 x .75 x 24	FTWH4324	225	270	294	318	342	366	390	414	438	462	486	510	534	582
83 Half Width	41.5 x .75 x 24	FTWH4124	211	257	280	303	326	349	372	395	418	441	464	487	510	556
76 Half Width	38 x .75 x 24	FTWH3824	194	235	256	277	298	319	340	361	382	403	424	445	466	508
70 Half Width	35 x .75 x 24	FTWH3524	178	217	237	257	277	297	317	337	357	377	397	417	437	477
64 Half Width	32 x .75 x 24	FTWH3224	161	198	216	234	252	270	288	306	324	342	360	378	396	432

Standard Features

- Constructed of .875" thick fiberboard
- Fabric is precisely aligned and fitted to the tackboard
- Adhered to the rigid hardboard with staples
- Hung with Z-Strip mounting system

Notes

- Half width tackboards can be specified and combined with a Veneer Panel, Marker Board, or Glass Board. See "Half Width" items under product width.
- Specify right or left facing tackboard

DARRAN

Wall hung dry marker board
Full width dry marker board

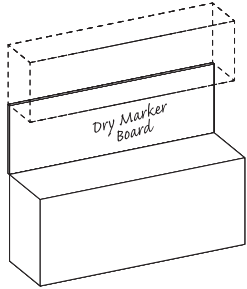

Product Width	Panel Dimension	SKU	List
93	93 x .75 x 24	DMWH9324	1161
87	87 x .75 x 24	DMWH8724	1086
83	83 x .75 x 24	DMWH8324	1023
76	76 x .75 x 24	DMWH7624	948
70	70 x .75 x 24	DMWH7024	874
64	64 x .75 x 24	DMWH6424	799
58	58 x .75 x 24	DMWH5824	724
47	47 x .75 x 24	DMWH4724	587
35	35 x .75 x 24	DMWH3524	437
29	29 x .75 x 24	DMWH2924	362

Standard Features

- Dry marker panel has edge trim molding
- Standard magnetic surface
- Hung with Z-Strip mounting system

Wall hung dry marker board
Half width dry marker board

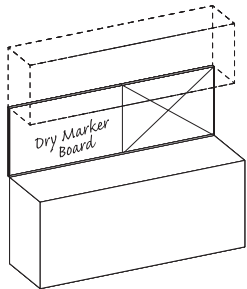

Product Width	Panel Dimension	SKU	List
93 Half Width	46.5 x .75 x 24	DMWH4624	580
87 Half Width	43.5 x .75 x 24	DMWH4324	543
83 Half Width	41.5 x .75 x 24	DMWH4124	518
76 Half Width	38 x .75 x 24	DMWH3824	474
70 Half Width	35 x .75 x 24	DMWH3524	437
64 Half Width	32 x .75 x 24	DMWH3224	399

Standard Features

- Dry marker panel has edge trim molding
- Standard magnetic surface
- Hung with Z-Strip mounting system

- Specify right or left facing dry marker board

Notes

- Half width dry marker boards can be specified and combined with a Tackboard, Veneer Panel, or Glass Board. See "Half Width" items under product width.

DARRAN

Wall hung glassboard Full width glassboards

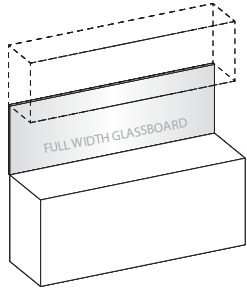

Product Width	Panel Dimension	SKU	List
93	93 x .75 x 24	GBWH9324	2753
87	87 x .75 x 24	GBWH8724	2586
83	83 x .75 x 24	GBWH8324	2475
76	76 x .75 x 24	GBWH7624	2281
70	70 x .75 x 24	GBWH7024	2114
64	64 x .75 x 24	GBWH6424	1948
58	58 x .75 x 24	GBWH5824	1780
47	47 x .75 x 24	GBWH4724	1476
35	35 x .75 x 24	GBWH3524	1142
29	29 x .75 x 24	GBWH2924	976

Standard Features

- 4 mm tempered glass
- Hung with Z-Strip mounting system

Notes

- Use glass cleaner or alcohol to clean
- Standard dry erase markers may be used
- Earth magnets are required to hold items securely in place

Wall hung glassboard Half width glassboards

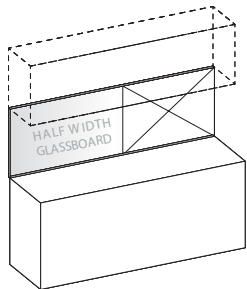

93 Half Width	46.5 x .75 x 24	GBWH4624	1461
87 Half Width	43.5 x .75 x 24	GBWH4324	1378
83 Half Width	41.5 x .75 x 24	GBWH4124	1323
76 Half Width	38 x .75 x 24	GBWH3824	1232
70 Half Width	35 x .75 x 24	GBWH3524	1142
64 Half Width	32 x .75 x 24	GBWH3224	1059

Standard Features

- 4 mm tempered glass
- Hung with Z-Strip mounting system

Notes

- Half width glassboards can be specified and combined with a Tackboard, Veneer panel, Marker Board. See "Half Width" items under product width.
- Specify right or left facing glassboard
- Use glass cleaner or alcohol to clean
- Standard dry erase markers may be used
- Earth magnets are required to hold items securely in place

Capitol Park

Single Height Wall Hung Overheads
Panel Doors - 6/4/2 Door

[Click here to view statement of line](#)

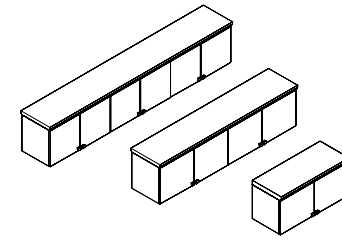

1 Select Model

w" x d" x h"

Weight	Standard Veneer Top Standard Veneer Chassis	Premium Veneer Top Premium Veneer Chassis	High Pressure Laminate Top Veneer Chassis	Thermally Fused Laminate Top Thermally Fused Laminate Chassis
6 Door				
93 x 15 x 19	240 CAP9319WH330W 5304	"P" Option N/A	"G" Option N/A	"M" Option N/A
87 x 15 x 19	225 CAP8719WH330W 5046	"P" Option N/A	"G" Option N/A	"M" Option N/A
4 Door				
83 x 15 x 19	210 CAP8319WH330W 4386	"P" Option N/A	"G" Option N/A	"M" Option N/A
76 x 15 x 19	195 CAP7619WH330W 4168	"P" Option N/A	"G" Option N/A	"M" Option N/A
70 x 15 x 19	180 CAP7019WH330W 3953	"P" Option N/A	"G" Option N/A	"M" Option N/A
64 x 15 x 19	160 CAP6419WH330W 3664	"P" Option N/A	"G" Option N/A	"M" Option N/A
58 x 15 x 19	135 CAP5819WH330W 3299	"P" Option N/A	"G" Option N/A	"M" Option N/A
47 x 15 x 19	125 CAP4719WH330W 2876	"P" Option N/A	"G" Option N/A	"M" Option N/A
2 Door				
35 x 15 x 19	75 CAP3519WH330W 2148	"P" Option N/A	"G" Option N/A	"M" Option N/A
29 x 15 x 19	65 CAP2919WH330W 2090	"P" Option N/A	"G" Option N/A	"M" Option N/A
23 x 15 x 19	55 CAP2319WH330W 2039	"P" Option N/A	"G" Option N/A	"M" Option N/A

2 Select Finish

[Click to view Veneer Finishes](#)

3 Select Edge

[Click to view edges](#)



4 Select Hardware

[Click to view details](#)



DK-125 Antique Pewter
DK-126 Antique English
DK-127 Matte Black

Product Features

- Doors are a matched set
- Finished front edge
- Interior cabinet depth 12"
- Mounting rail included
- Top shaped on front only

Notes

- The DARRAN wall mounted cabinet(or shelf) must be hung on a weight-bearing wall. The suitability of the wall supporting the wall mounted cabinet, and the installation and maintenance of the wall-mounted cabinet, is the sole responsibility of the customer. Failure to correctly install and/or exceed the loaded weight capacity of this product may cause it to fall, resulting in damage to the product, adjacent property and/or bodily injury.

Options

Door

- D2: Door Lock - \$100 per door set
- D6: Delete Doors - n/c
- D9SC: Soft Close Door Hinges - \$20 per door

Task Lighting (Recessed)

Overhead task light cord is located on the right facing side. If the opposite location is required please contact customer service.

- LT-LED24: 24" LED Task light - \$215
- LT-LED48: 48" LED Task light - \$270
- LT-LED60: 60" LED Task light - \$335
- LT-LED72: 72" LED Task light - \$360

DARRAN

Overhead tackboard Full width tackboards

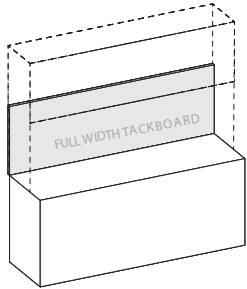

Product Width	Panel Dimension	SKU	COM	1	2	3	4	5	6	7	8	9	10	11/L1	12	13/L2
94	91 x .75 x 21	FTOC9121	379	480	531	582	633	684	735	786	837	888	939	990	1041	1143
88	85 x .75 x 21	FTOC8521	358	449	497	545	593	641	689	737	785	833	881	929	977	1073
84	81 x .75 x 21	FTOC8121	336	428	474	520	566	612	658	704	750	796	842	888	934	1026
77	74 x .75 x 21	FTOC7421	309	392	435	478	521	564	607	650	693	736	779	822	865	951
71	68 x .75 x 21	FTOC6821	282	361	401	441	481	521	561	601	641	681	721	761	801	881
65	62 x .75 x 21	FTOC6221	256	330	366	402	438	474	510	546	582	618	654	690	726	798
59	56 x .75 x 21	FTOC5621	234	299	331	363	395	427	459	491	523	555	587	619	651	715
48	45 x .75 x 21	FTOC4521	187	242	269	296	323	350	377	404	431	458	485	512	539	593
36	33 x .75 x 21	FTOC3321	141	180	200	220	240	260	280	300	320	340	360	380	400	440
30	27 x .75 x 21	FTOC2721	112	149	166	183	200	217	234	251	268	285	302	319	336	370

Standard Features

- Constructed of .5" thick fiberboard
- Fabric is precisely aligned and fitted to the tackboard
- Adhered to the rigid hardboard with staples
- Hung with Z-Strip mounting system

Notes

- Fabric Tack Panels are raised 3" from bottom edge when TM50 grommet is ordered

Overhead tackboard Half width tackboards

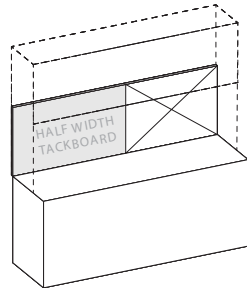

Product Width	Panel Dimension	SKU	COM	1	2	3	4	5	6	7	8	9	10	11/L1	12	13/L2
94 Half Width	45.5 x .75 x 21	FTOC4521	189	240	266	292	318	344	370	396	422	448	474	500	526	578
88 Half Width	42.5 x .75 x 21	FTOC4221	179	225	249	273	297	321	345	369	393	417	441	465	489	537
84 Half Width	40.5 x .75 x 21	FTOC4021	168	214	237	260	283	306	329	352	375	398	421	444	467	513
77 Half Width	37 x .75 x 21	FTOC3721	155	196	217	238	259	280	301	322	343	364	385	406	427	469
71 Half Width	34 x .75 x 21	FTOC3421	141	180	200	220	240	260	280	300	320	340	360	380	400	440
65 Half Width	31 x .75 x 21	FTOC3121	128	165	183	201	219	237	255	273	291	309	327	345	363	399

Standard Features

- Constructed of .5" thick fiberboard
- Fabric is precisely aligned and fitted to the tackboard
- Adhered to the rigid hardboard with staples
- Hung with Z-Strip mounting system

Notes

- Half width tackboards can be specified and combined with Marker Board, and Glass Board options. See "Half Width" items under product width.
- Specify right or left facing tackboard
- Fabric Tack Panels are raised 3" from bottom edge when TM50 grommet is ordered

DARRAN

Overhead dry marker board
Full width dry marker board

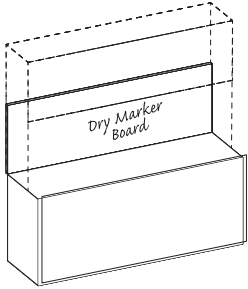

Product Width	Panel Dimension	SKU	List
94	91 x .5 x 21	DMOC9121	1136
88	85 x .5 x 21	DMOC8521	1061
84	81 x .5 x 21	DMOC8121	1011
77	74 x .5 x 21	DMOC7421	924
71	68 x .5 x 21	DMOC6821	849
65	62 x .5 x 21	DMOC6221	774
59	56 x .5 x 21	DMOC5621	699
48	45 x .5 x 21	DMOC4521	587
36	33 x .5 x 21	DMOC3321	437
30	27 x .5 x 21	DMOC2721	337

Standard Features

- Dry marker panel has edge trim molding
- Standard magnetic surface
- Hung with Z-Strip mounting system

Overhead dry marker board
Half width dry marker board

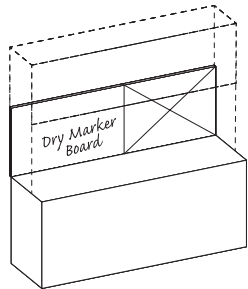

Product Width	Panel Dimension	SKU	List
94 Half Width	45.5 x .5 x 21	DMOC4521	555
88 Half Width	42.5 x .5 x 21	DMOC4221	518
84 Half Width	40.5 x .5 x 21	DMOC4021	493
77 Half Width	37 x .5 x 21	DMOC3721	449
71 Half Width	34 x .5 x 21	DMOC3421	437
65 Half Width	31 x .5 x 21	DMOC3121	374

Standard Features

- Dry marker panel has edge trim molding
- Standard magnetic surface
- Hung with Z-Strip mounting system

Notes

- Half width dry marker boards can be specified and combined with a Tackboard, Veneer Panel, or Glass Board. See "Half Width" items under product width.
- Specify right or left facing dry marker board

DARRAN

Wall hung veneer panel
Full width veneer panel

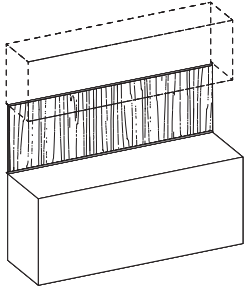

Product Width	Panel Dimension	SKU	List
93	93 x .75 x 24	VPWH9324	967
87	87 x .75 x 24	VPWH8724	905
83	83 x .75 x 24	VPWH8324	853
76	76 x .75 x 24	VPWH7624	790
70	70 x .75 x 24	VPWH7024	728
64	64 x .75 x 24	VPWH6424	666
58	58 x .75 x 24	VPWH5824	603
47	47 x .75 x 24	VPWH4724	489
35	35 x .75 x 24	VPWH3524	364
29	29 x .75 x 24	VPWH2924	302

Standard Features

- Veneer edges
- Vertical wire channels on back for task light cords
- Hung with Z-Strip mounting system

Notes

- Steel mounting wall channel is recessed for flush mounting
- Can be used with or without overhead cabinet
- Required for other accessory panels

Wall hung veneer panel
Half width veneer panel

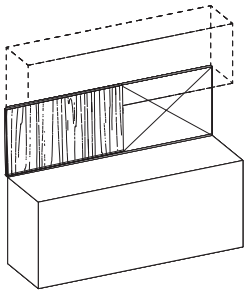

Product Width	Panel Dimension	SKU	List
93 Half Width	46.5 x .75 x 24	VPWH4624	484
87 Half Width	43.5 x .75 x 24	VPWH4324	452
83 Half Width	41.5 x .75 x 24	VPWH4124	432
76 Half Width	38 x .75 x 24	VPWH3824	395
70 Half Width	35 x .75 x 24	VPWH3524	364
64 Half Width	32 x .75 x 24	VPWH3224	333

Standard Features

- Veneer edges.
- Vertical wire channels on back for task light cords
- Steel mounting wall channel is recessed for flush mounting
- Hung with Z-Strip mounting system

Notes

- Half width veneer panels can be specified and combined with a Tackboard, Marker Board, or Glass Board. See "Half Width" items under product width.
- Specify right or left facing veneer panel
- Can be used with or without overhead cabinet
- Required for other accessory panels

DARRAN

Overhead glassboard Full width glassboard

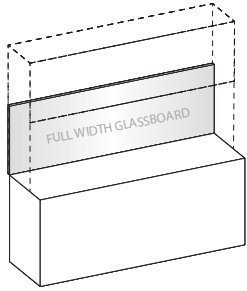

Product Width	Panel Dimension	SKU	List
94	91 x .5 x 21	GBOC9121	2382
88	85 x .5 x 21	GBOC8521	2236
84	81 x .5 x 21	GBOC8121	2138
77	74 x .5 x 21	GBOC7421	1969
71	68 x .5 x 21	GBOC6821	1822
65	62 x .5 x 21	GBOC6221	1676
59	56 x .5 x 21	GBOC5621	1531
48	45 x .5 x 21	GBOC4521	1264
36	33 x .5 x 21	GBOC3321	972
30	27 x .5 x 21	GBOC2721	826

Standard Features

- 4 mm tempered glass
- Hung with Z-Strip mounting system

Notes

- Use glass cleaner or alcohol to clean
- Standard dry erase markers may be used
- Earth magnets are required to hold items securely in place

Overhead glassboard Half width glassboard

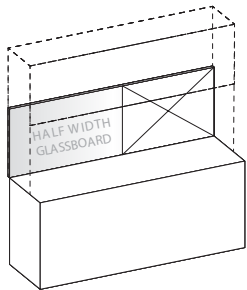

Product Width	Panel Dimension	SKU	List
94 Half Width	45.5 x .5 x 21	GBOC4521	1251
88 Half Width	42.5 x .5 x 21	GBOC4221	1178
84 Half Width	40.5 x .5 x 21	GBOC4021	1129
77 Half Width	37 x .5 x 21	GBOC3721	985
71 Half Width	34 x .5 x 21	GBOC3421	972
65 Half Width	31 x .5 x 21	GBOC3121	899

Standard Features

- 4 mm tempered glass
- Hung with Z-Strip mounting system

Notes

- Half width glassboards can be specified and combined with a Tackboard, Veneer panel, Marker Board. See "Half Width" items under product width.
- Specify right or left facing glassboard
- Use glass cleaner or alcohol to clean
- Standard dry erase markers may be used
- Earth magnets are required to hold items securely in place

Capitol Park

Sit-On Tower Extension
Panel Door - Full Storage

[Click here to view statement of line](#)

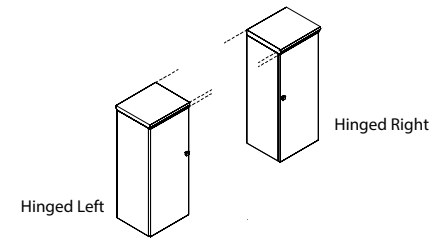

1 Select Model

w" x d" x h"
Hinged Left
17.5 x 15 x 43
14.5 x 15 x 43
Hinged Right
17.5 x 15 x 43
14.5 x 15 x 43

Weight

		Standard Veneer Top Standard Veneer Chassis	Premium Veneer Top Premium Veneer Chassis	High Pressure Laminate Top Veneer Chassis	Thermally Fused Laminate Top Thermally Fused Laminate Chassis
80	CAP1743OH340W	2222	"P" Option N/A	"G" Option N/A	"M" Option N/A
75	CAP1443OH340W	2142	"P" Option N/A	"G" Option N/A	"M" Option N/A
80	CAP1743OH341W	2222	"P" Option N/A	"G" Option N/A	"M" Option N/A
75	CAP1443OH341W	2142	"P" Option N/A	"G" Option N/A	"M" Option N/A

Product Features

- 2 adjustable wood shelves
- Finished front edge
- Interior shelf depth 12"
- Top shaped on front only

Notes

- Unit has black back panel and is not designed for Open Plan use. Select OPB Option for Open Plan application

Options

Door

- D2: Door Lock - \$100 per door
- D6: Delete Doors - n/c
- D9SC: Soft Close Door Hinges - \$20 per door

Open Plan _ Finished Back

- OPB:Modify Unit for Open Plan Application - \$395

2 Select Finish

[Click to view Veneer Finishes](#)

3 Select Edge

[Click to view edges](#)



4 Select Hardware

[Click to view details](#)



DK-125 Antique Pewter
DK-126 Antique English
DK-127 Matte Black

Capitol Park

Sit-On Tower Extension

Wood Frame Door/Clear Glass Insert - Full Storage

[Click here to view statement of line](#)

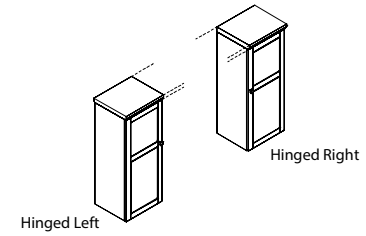

1 Select Model

w" x d" x h"	Weight
Hinged Left	
17.5 x 15 x 43	80
14.5 x 15 x 43	75
Hinged Right	
17.5 x 15 x 43	80
14.5 x 15 x 43	75

	Standard Veneer Top Standard Veneer Chassis	Premium Veneer Top Premium Veneer Chassis	High Pressure Laminate Top Veneer Chassis	Thermally Fused Laminate Top Thermally Fused Laminate Chassis

Product Features

- 2 adjustable wood shelves
- Finished front edge
- Interior shelf depth 12"
- Top shaped on front only

Notes

- Unit has black back panel and is not designed for Open Plan use. Select OPB Option for Open Plan application

Options

Door

- D2-G: Door Lock for Glass Doors - \$205 per door set
- D9SC: Soft Close Door Hinges - \$20 per door

Interior Cabinet Lighting

- LEDPK starter kit includes Infeed, 1 Puck Interior Light and the ability to daisy chain up to 6 total Puck Lights
- LEDPK: LED Puck Starter Kit - \$310
- PK: 1 LED Interior Light - \$130

Open Plan _ Finished Back

- OPB:Modify Unit for Open Plan Application - \$395

Shelves

- GS14H: Replace Standard Shelves with Glass Shelf - \$70 per shelf

2 Select Finish

[Click to view Veneer Finishes](#)

3 Select Edge

[Click to view edges](#)



4 Select Hardware

[Click to view details](#)



DK-125 Antique Pewter
DK-126 Antique English
DK-127 Matte Black

Capitol Park

Sit-On Bookcase Console
Panel Door

[Click here to view statement of line](#)

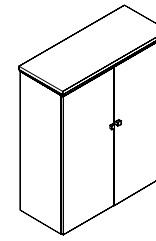

1 Select Model

w" x d" x h"	Weight
36 x 15 x 43	150
30 x 15 x 43	130

Standard Veneer Top Standard Veneer Chassis		Premium Veneer Top Premium Veneer Chassis	High Pressure Laminate Top Veneer Chassis	Thermally Fused Laminate Top Thermally Fused Laminate Chassis
CAP3643OH383W	2911	"P" Option N/A	"G" Option N/A	"M" Option N/A
CAP3043OH383W	2786	"P" Option N/A	"G" Option N/A	"M" Option N/A

Product Features

- 2 adjustable wood shelves
- Finished front edge
- Interior shelf depth 12"
- Top shaped on 3 sides

Notes

- Unit has black back panel and is not designed for Open Plan use. Select OPB Option for Open Plan application

Options

Door

- D2: Door Lock - \$100 per door set
- D6: Delete Doors - n/c
- D9SC: Soft Close Door Hinges - \$20 per door

Flush Cut

- FC-B: Flush Unit Both Sides(Facing) for Ganging - \$100
- FC-L: Flush Unit Left (Facing) for Ganging - \$100
- FC-R: Flush Unit Right(Facing) for Ganging - \$100

Open Plan _ Finished Back

- OPB:Modify Unit for Open Plan Application - \$395

2 Select Finish

[Click to view Veneer Finishes](#)

3 Select Edge

[Click to view edges](#)



Capitol

4 Select Hardware

[Click to view details](#)



DK-125 Antique Pewter
DK-126 Antique English
DK-127 Matte Black

Capitol Park

Sit-On Bookcase Console
 Frame Door With Clear Glass

[Click here to view statement of line](#)

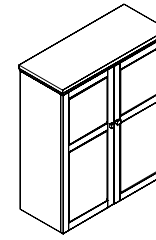

1 Select Model

w" x d" x h"	Weight
36 x 15 x 43	150
30 x 15 x 43	130

Standard Veneer Top Standard Veneer Chassis		Premium Veneer Top Premium Veneer Chassis	High Pressure Laminate Top Veneer Chassis	Thermally Fused Laminate Top Thermally Fused Laminate Chassis
CAP3643OH381W	3781	"P" Option N/A	"G" Option N/A	"M" Option N/A
CAP3043OH381W	3656	"P" Option N/A	"G" Option N/A	"M" Option N/A

Product Features

- 2 adjustable wood shelves
- Finished front edge
- Interior shelf depth 12"
- Top shaped on 3 sides

Notes

- Unit has black back panel and is not designed for Open Plan use. Select OPB Option for Open Plan application

Options

Door

- D2-G: Door Lock for Glass Doors - \$205 per door set
- D9SC: Soft Close Door Hinges - \$20 per door

Flush Cut

- FC-B: Flush Unit Both Sides(Facing) for Ganging - \$100
- FC-L: Flush Unit Left (Facing) for Ganging - \$100
- FC-R: Flush Unit Right(Facing) for Ganging - \$100

Interior Cabinet Lighting

- LEDPK starter kit includes Infeed, 1 Puck Interior Light and the ability to daisy chain up to 6 total Puck Lights
- LEDPK: LED Puck Starter Kit - \$310
- PK: 1 LED Interior Light - \$130

Open Plan _ Finished Back

- OPB:Modify Unit for Open Plan Application - \$395

Shelves

- GS14F: Replace Standard Shelves with Glass Shelves - \$90 per shelf
- S714F: Heavy Duty Lumber 1" Shelves - \$80 per shelf

2 Select Finish

[Click to view Veneer Finishes](#)

3 Select Edge

[Click to view edges](#)



4 Select Hardware

[Click to view details](#)



DK-125 Antique Pewter
 DK-126 Antique English
 DK-127 Matte Black

Capitol Park

Half Towers
Half Wardrobe - Left/Right Hinge

[Click here to view statement of line](#)

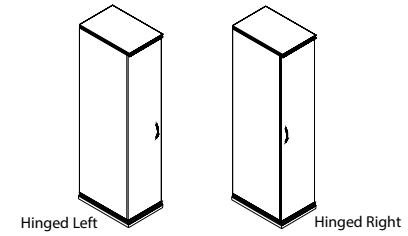

1 Select Model

w" x d" x h"
Hinged Left
16 x 24 x 72
Hinged Right
16 x 24 x 72

Weight	Standard Veneer Top Standard Veneer Chassis	Premium Veneer Top Premium Veneer Chassis	High Pressure Laminate Top Veneer Chassis	Thermally Fused Laminate Top Thermally Fused Laminate Chassis
155	CAP1672TW283W 3912	"P" Option N/A	"G" Option N/A	"M" Option N/A
155	CAP1672TW284W 3912	"P" Option N/A	"G" Option N/A	"M" Option N/A

Product Features

- 1 Fixed shelf
- 3 Adjustable shelves
- Finished front edge
- Top shaped on 3 sides
- Wardrobe w/ coat rod & hook
- Panel door w/ pull
- Hardwood base w/ mitred corners

Notes

- Unit has black back panel and is not designed for Open Plan use. Select OPB Option for Open Plan application

Options

- Door**
- D2: Door Lock - \$100 per door
 - D6: Delete Doors - n/c
 - D9SC: Soft Close Door Hinges - \$20 per door
- Flush Cut**
- FC-B: Flush Unit Both Sides(Facing) for Ganging - \$100
 - FC-L: Flush Unit Left (Facing) for Ganging - \$100
 - FC-R: Flush Unit Right(Facing) for Ganging - \$100
- Open Plan _ Finished Back**
- OPB:Modify Unit for Open Plan Application - \$395

2 Select Finish

[Click to view Veneer Finishes](#)

3 Select Edge

[Click to view edges](#)



4 Select Hardware

[Click to view details](#)



Capitol Park

Full Towers
Full Wardrobe

[Click here to view statement of line](#)

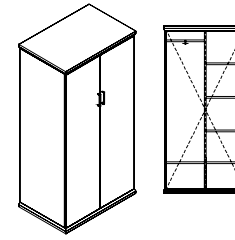

1 Select Model

w" x d" x h"	Weight
36 x 24 x 72	285
30 x 24 x 72	240

Standard Veneer Top Standard Veneer Chassis		Premium Veneer Top Premium Veneer Chassis	High Pressure Laminate Top Veneer Chassis	Thermally Fused Laminate Top Thermally Fused Laminate Chassis
CAP3672TW275W	6042	"P" Option N/A	"G" Option N/A	"M" Option N/A
CAP3072TW275W	5788	"P" Option N/A	"G" Option N/A	"M" Option N/A

Product Features

- 2 Fixed shelves
- 3 Adjustable shelves
- Finished front edge
- Hardwood base w/ mitred corners
- Top shaped on 3 sides
- Wardrobe w/ coat rod & hook
- Panel doors w/ pulls

Notes

- Unit has black back panel and is not designed for Open Plan use. Select OPB Option for Open Plan application

Options

Delete Center Partition

- MOD31: Delete center partition & Add 3 full width shelves, 1 fixed - \$295
- When deleting center partition (1) D2 Door lock should be specified

Door

- D2: Door Lock - \$100 per door
- D6: Delete Doors - n/c
- D9SC: Soft Close Door Hinges - \$20 per door

Flush Cut

- FC-B: Flush Unit Both Sides(Facing) for Ganging - \$100
- FC-L: Flush Unit Left (Facing) for Ganging - \$100
- FC-R: Flush Unit Right(Facing) for Ganging - \$100

Open Plan _ Finished Back

- OPB:Modify Unit for Open Plan Application - \$395

2 Select Finish

[Click to view Veneer Finishes](#)

3 Select Edge

[Click to view edges](#)



4 Select Hardware

[Click to view details](#)

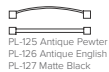

Capitol Park

Full Towers
2 Lateral File / Wardrobe

[Click here to view statement of line](#)

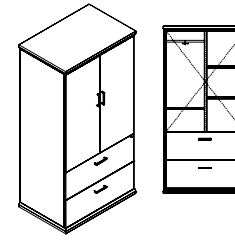

1 Select Model

w" x d" x h"

36 x 24 x 72

30 x 24 x 72

Weight

310

280

Standard Veneer Top Standard Veneer Chassis	Premium Veneer Top Premium Veneer Chassis	High Pressure Laminate Top Veneer Chassis	Thermally Fused Laminate Top Thermally Fused Laminate Chassis
CAP3672TW281W 6390 CAP3072TW281W 6134	"P" Option N/A "P" Option N/A	"G" Option N/A "G" Option N/A	"M" Option N/A "M" Option N/A

Product Features

- 3 Adjustable shelves
- Finished front edge
- Hardwood base w/ mitred corners
- Top shaped on 3 sides
- Wardrobe w/ coat rod & hook
- Panel doors w/ pulls
- Features ball bearing suspensions, suspensions are full extension.

Notes

- Unit has black back panel and is not designed for Open Plan use. Select OPB Option for Open Plan application

Options

Door

- D2: Door Lock - \$100 per door
- D6: Delete Doors - n/c
- D9SC: Soft Close Door Hinges - \$20 per door

Drawer

- P33: Wood Drawer Upgrade - \$45 per drawer

Flush Cut

- FC-B: Flush Unit Both Sides(Facing) for Ganging - \$100
- FC-L: Flush Unit Left (Facing) for Ganging - \$100
- FC-R: Flush Unit Right(Facing) for Ganging - \$100

Open Plan _ Finished Back

- OPB:Modify Unit for Open Plan Application - \$395

Shelves

- MOD30: Delete center partition & Add 2 full width shelves (When specifying MOD30, 1 lock needed)- \$195

2 Select Finish

[Click to view Veneer Finishes](#)

3 Select Edge

[Click to view edges](#)



4 Select Hardware

[Click to view details](#)

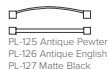

Capitol Park

Freestanding Bookcases
Open Bookcases

[Click here to view statement of line](#)

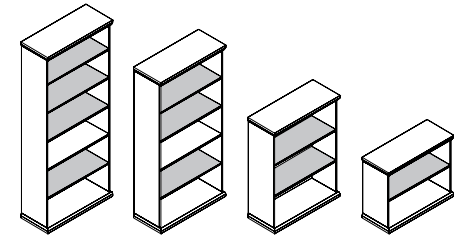

1 Select Model

w" x d" x h"	Weight
36" Width	
36 x 15 x 84	200
36 x 15 x 72	175
36 x 15 x 48	120
36 x 15 x 30.75	95
30" Width	
30 x 15 x 84	180
30 x 15 x 72	155
30 x 15 x 48	105
30 x 15 x 30.75	85

	Standard Veneer Top Standard Veneer Chassis	Premium Veneer Top Premium Veneer Chassis	High Pressure Laminate Top Veneer Chassis	Thermally Fused Laminate Top Thermally Fused Laminate Chassis
		"P" Option N/A	"G" Option N/A	"M" Option N/A
		"P" Option N/A	"G" Option N/A	"M" Option N/A
		"P" Option N/A	"G" Option N/A	"M" Option N/A
		"P" Option N/A	"G" Option N/A	"M" Option N/A
		"P" Option N/A	"G" Option N/A	"M" Option N/A
		"P" Option N/A	"G" Option N/A	"M" Option N/A
		"P" Option N/A	"G" Option N/A	"M" Option N/A
		"P" Option N/A	"G" Option N/A	"M" Option N/A

Product Features

- 1 Fixed shelf on 84" & 72"
- Interior shelf depth 12"
- Hardwood base w/ mitred corners
- Top shaped 3 sides
- 30", 48", and 72" H units finished front edge, 84" H units black painted top

Notes

- 30.75"H Open Bookcases are NOT meant to gang with desks, returns and credenzas. Unit is higher than regular worksurfaces to allow double binder storage. If matching height is desired, choose CAP-3624CA125W or CAP3024CA125W with D6A option
- 12" Deep Shelves
- Unit has black back panel and is not designed for Open Plan use. Select OPB Option for Open Plan application

Options

Flush Cut

- FC-B: Flush Unit Both Sides(Facing) for Ganging - \$100
- FC-L: Flush Unit Left (Facing) for Ganging - \$100
- FC-R: Flush Unit Right(Facing) for Ganging - \$100

Interior Cabinet Lighting

- LEDPK starter kit includes Infeed, 1 Puck Interior Light and the ability to daisy chain up to 6 total Puck Lights
- LEDPK: LED Puck Starter Kit - \$310
- PK: 1 LED Interior Light - \$130

Open Plan _ Finished Back

- OPB:Modify Unit for Open Plan Application - \$395

Shelves

- GS14F: Replace Standard Shelves with Glass Shelves - \$90 per shelf
- S714F: Heavy Duty Lumber 1" Shelves - \$80 per shelf

2 Select Finish

[Click to view Veneer Finishes](#)

3 Select Edge

[Click to view edges](#)



4 Select Hardware

[Click to view details](#)

Hardware
N/A

Capitol Park

Freestanding Bookcases

Bookcases W/ Doors

[Click here to view statement of line](#)

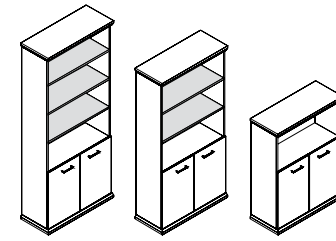

1 Select Model

w" x d" x h"	Weight
36" Width	
36 x 15 x 84	210
36 x 15 x 72	185
36 x 15 x 48	130
30" Width	
30 x 15 x 84	190
30 x 15 x 72	165
30 x 15 x 48	115

	Standard Veneer Top Standard Veneer Chassis	Premium Veneer Top Premium Veneer Chassis	High Pressure Laminate Top Veneer Chassis	Thermally Fused Laminate Top Thermally Fused Laminate Chassis
	CAP3684BK251W 3524	"P" Option N/A	"G" Option N/A	"M" Option N/A
	CAP3672BK251W 3257	"P" Option N/A	"G" Option N/A	"M" Option N/A
	CAP3648BK251W 3085	"P" Option N/A	"G" Option N/A	"M" Option N/A
	CAP3084BK251W 3348	"P" Option N/A	"G" Option N/A	"M" Option N/A
	CAP3072BK251W 3085	"P" Option N/A	"G" Option N/A	"M" Option N/A
	CAP3048BK251W 2959	"P" Option N/A	"G" Option N/A	"M" Option N/A

Product Features

- 72" w/ 3 adj. shelves
- 84" w/ 4 adjustable shelves
- Hardwood base w/ mitred corners.
- Interior shelf depth 12"
- Top shaped on 3 sides
- Panel doors w/ pulls
- 48", 72" H units finished front edge, 84" H units black painted top

Notes

- Unit has black back panel and is not designed for Open Plan use. Select OPB Option for Open Plan application

Options

Door

- D2: Door Lock - \$100 per door set
- D9SC: Soft Close Door Hinges - \$20 per door

Flush Cut

- FC-B: Flush Unit Both Sides(Facing) for Ganging - \$100
- FC-L: Flush Unit Left (Facing) for Ganging - \$100
- FC-R: Flush Unit Right(Facing) for Ganging - \$100

Interior Cabinet Lighting

- LEDPK starter kit includes Infeed, 1 Puck Interior Light and the ability to daisy chain up to 6 total Puck Lights
- LEDPK: LED Puck Starter Kit - \$310
- PK: 1 LED Interior Light - \$130

Open Plan _ Finished Back

- OPB:Modify Unit for Open Plan Application - \$395

Shelves

- GS14F: Replace Standard Shelves with Glass Shelves - \$90 per shelf
- S714F: Heavy Duty Lumber 1" Shelves - \$80 per shelf

2 Select Finish

[Click to view Veneer Finishes](#)

3 Select Edge

[Click to view edges](#)



4 Select Hardware

[Click to view details](#)



DK-125 Antique Pewter
DK-126 Antique English
DK-127 Matte Black



PL-115 Matte Black
PL-116 Matte Nickel
PL-125 Antique Pewter
PL-126 Antique English
PL-127 Matte Black



COMPUTER SUPPORT
single monitor arm

COMPUTER SUPPORT
double monitor arm

COMPUTER SUPPORT
triple monitor arm

COMPUTER SUPPORT
quadruple monitor arm

Style Number	List Price
MA1	280

Style Number	List Price
MA2	450

Style Number	List Price
MA3	530

Style Number	List Price
MA4	705

Specifications

- Available in black or silver
- Desk clamp and mounting included
- Easy assembly and flexibility
- Elastic painting process for a durable and beautiful finish
- Gas spring tension adjustment for counter-balance height adjustment for monitors 1-8 KG
- Gas spring tested to 50,000 repetitions
- Hidden cable management

Specifications

- Available in black or silver
- Desk clamp and mounting included
- Easy assembly and flexibility
- Elastic painting process for a durable and beautiful finish
- Gas spring tension adjustment for counter-balance height adjustment for monitors 1-8 KG
- Gas spring tested to 50,000 repetitions
- Hidden cable management

Specifications

- Available in black or silver
- Desk clamp and mounting included
- Easy assembly and flexibility
- Elastic painting process for a durable and beautiful finish
- Gas spring tension adjustment for counter-balance height adjustment for monitors 1-8 KG
- Gas spring tested to 50,000 repetitions
- Hidden cable management

Specifications

- Available in black
- Desk clamp and mounting included
- Easy assembly and flexibility
- Elastic painting process for a durable and beautiful finish
- Gas spring tension adjustment for counter-balance height adjustment for monitors 1-8 KG
- Gas spring tested to 50,000 repetitions
- Hidden cable management

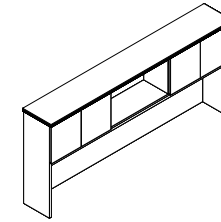
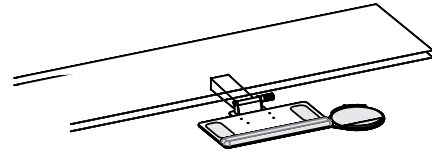
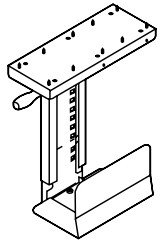

COMPUTER SUPPORT
cpu retractable cradle

COMPUTER SUPPORT
articulating keyboard tray

DOOR MODIFICATIONS
soft close door hinge

DOOR MODIFICATIONS
delete doors

Style Number	List Price
K18	205

Style Number	List Price
Factory Installed	
K28	390
Field Installed	
K28F	415

Style Number	List Price
D9SC	20 Per door

Style Number	List Price
D6	N/C

Specifications

- Black Metal CPU Carriage
- Full 360° swivel capability allows easy access to rear of CPU for cables / wires
- Track allows 8- 1/2" extension
- Width Adjustment 5-1/2" to 9-1/4"
- Height adjustment 14- 5/8" to 20- 1/2"
- Black epoxy finish

Notes
- Factory Installed

Specifications

- Adjusts effortlessly - A simple one-handed motion allows the keyboard to be repositioned instantly, without the use of locks or levers
- Encourages low-risk postures - Maximizes adjustability within a safe operating range.
- Will last a lifetime - Exceeds all applicable BIFMA Standards and comes with a lifetime guarantee.

Notes
- Available on: Freestanding Desk
- Factory Installed (standard)
- FIELD INSTALL - \$415

Specifications

- Snap onto standard door hinge
- Requires (2) per door
- Max door height 43"
- Factory installed where specified
- Individually shipped for field installation

Notes
- Specify Each Item To Have Slow Close Feature

Specifications

- Standard Door overheads and cabinets can have door deleted for open access. Modification of hinge rails and structural components are made face ready.

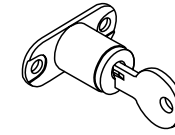
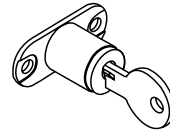
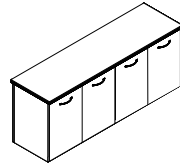
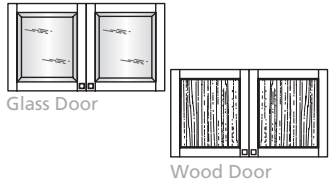

DOOR MODIFICATIONS

replace glass panel insert with veneer panel insert

Style Number	List Price
D35	35 per door

DOOR MODIFICATIONS

delete doors/replace black laminate shelf w/ finished shelf

Style Number	List Price
D6A	N/C

DOOR MODIFICATIONS

panel door lock

Style Number	List Price
D2	100 Per door set

DOOR MODIFICATIONS

glass door lock

Style Number	List Price
D2-G	205 Per door set

Specifications

- Replace glass panel insert with veneer panel insert

- Notes
- Not Available on "M" skus
 - Glass door has beveled glass
 - Wood door w/ veneer insert - only available on "W" style

Specifications

- Delete doors and replace black laminate shelf with finished shelf

- Notes
- Available on: All Storage "W"/"G" Style Credenzas.

Specifications

- Door Locks - 1 Door w/ Lock, Other Door w/ Catch Latch
 - Contact Customer Service regarding limited lock locations and keying.

- Notes
- Available on: Panel Doors, Wood Frame Doors, and Silverluma doors

Specifications

- Door Locks - 1 Door w/ Lock, Other Door w/ Catch Latch
 - Contact Customer Service regarding limited lock locations and keying.

- Notes
- Available on: Glass Doors

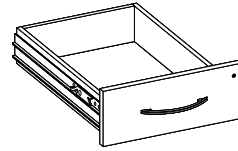
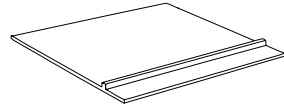
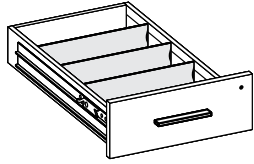

DRAWER OPTIONS
box drawer accessories

Style Number	List Price
Wood Drawer Dividers w/ Clips K-DIV	SET OF 3 - 30
Single Tray - Utility Tray K-Sut	35 ea.

DRAWER OPTIONS - BOTTOM COVER
felt bottom center drawer insert liner

Style Number	List Price
K3	100

DRAWER OPTIONS - UPGRADE
wood drawer upgrade

Style Number	List Price
P33	45 Per drawer

GLASSBOARD ACCESSORIES
glassboard accessory kit

Style Number	List Price
GBKIT	290

Specifications

- K-DIV Extra Wood Drawer Dividers with Clips, Top Box drawers standard with 1 divider
- K-SUT Single Tray - Utility Tray, Specify Legal or Letter drawer width

Specifications

- Inserts into center drawer and features divider for open pen and pencil storage. Removable for easy cleaning.
- Adds a luxurious touch to center drawers.
- Color: Dark Brown Coal

Specifications

- Dowel joint construction
- Hardwood veneer multi-ply drawer
- UV finish
- 1/4" Wood veneer bottoms
- File drawer bottoms are five block reinforced for heavy weight capacity
- Lifetime guaranteed

Specifications

- 8 Earth magnets, 1 magnetic marker cup holder and 1 magnetic dry eraser

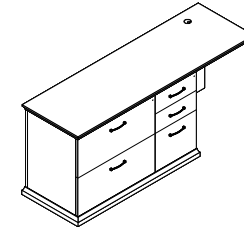
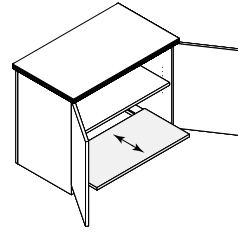
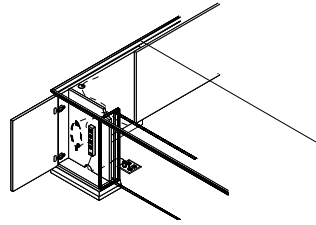
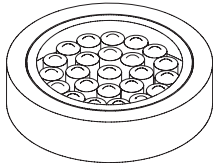

LIGHTING
led interior cabinet puck light

Style Number	List Price
Starter Kit	
LEDPK	310
1 LED Interior Puck Light	
PK	130

PEDESTAL MODIFICATIONS
breakfront pedestal with wire management cavity door

Style Number	List Price
PC10	100
Power Supply Cordset	
PD717	100

PEDESTAL MODIFICATIONS
black laminate printer pullout bottom shelf

Style Number	List Price
PPOS	225

PEDESTAL MODIFICATIONS
add veneer kneespace cabinets - base

Style Number	List Price
Add Box/Box/File or File/File	
P40B	1025
Add Lateral File 29" W	
P41B	1255
Add Multi-File - 31"W	
P42B	1255
Add Storage With Doors 29"W	
P43B	1140
Add CPU /Printer Cabinet - Open	
P44B	1140

Specifications

- Starter kit includes Infeed, 1 Puck Interior Light and the ability to daisy chain up to 6 total Puck Lights
- (1) LED Puck Light with 30W power drive and switch
- Recessed fixture
- 12V linking cord 98"L
- Silver finish
- 50,000 hour life
- 2 watt per light

Notes

- Available on: Overhead/Tower Units with glass doors or no doors
- Power drive included, Light only

Specifications

- Hinged pedestal front door offers easy access for wire management
- Wire hooks provide wire coil storage
- Wire access openings allow access to floor, cabinets interior and kneespace
- Cabinet interior is black finish
- Top grommet is positioned over cavity for access ease
- (Power Strip Optional)

Notes

- Breakfront Chassis Only

Specifications

- Black Laminate pullout shelf on suspension
- Black grommet in back
- Adjustable Shelf

Specifications

- Multi-file specify Box/Box Left or Right

Notes

- Add additional Standard Cabinets To Kneespace Area.

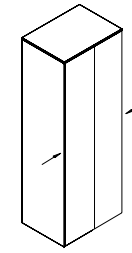
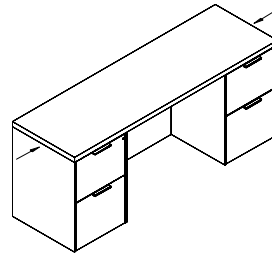
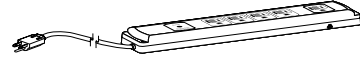
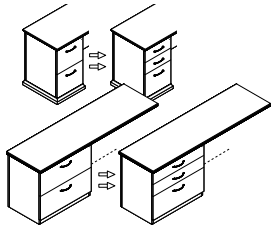

PEDESTAL MODIFICATIONS
modify drawer configurations

POWER / DATA
power supply cordset

PRODUCT MODIFICATIONS
modify width - open kneespace

PRODUCT MODIFICATIONS
modify width - open/closed storage

Style Number	List Price
File/File to Box/Box/File P6	55 Per ped
Box/Box/File to File/File P6	55 Per ped
Lateral File to 2 Box Drawers P8	100 Per ped

Style Number	List Price
PD717	100

Style Number	List Price
MOD-1	125

Style Number	List Price
MOD-2	250

Specifications

- Modify File/File To Box/Box/File - Any Unit

Specifications

- SIZE: 10.75"L x 2.0"W x 1.06"H
- (5) Outlets w/ 10' cord
- Surge suppression (720 Joules)
- 15 Amp breaker
- Available on: Vertical Panels, Cabinet Interiors, and under tops

Specifications

- Modify width down on any unit with an open kneespace: desk, workstation credenza, bridge, return

Specifications

- Modify width down on any unit with open or closed storage section: overheads, wall hung units, storage credenzas, towers

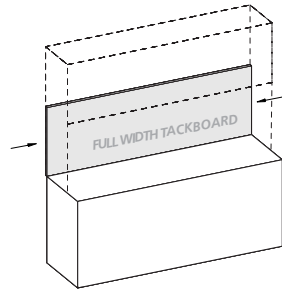

PRODUCT MODIFICATIONS
 modify width - tackboard, veneer panel, or a glassboard

Style Number	List Price
MOD-4	50

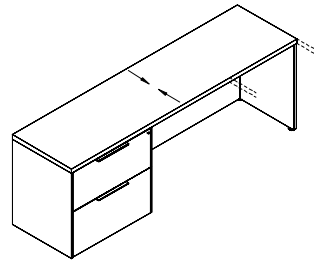

PRODUCT MODIFICATIONS
 modify depth - decrease depth

Style Number	List Price
MOD-5	125

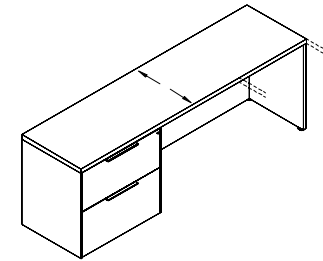

PRODUCT MODIFICATIONS
 modify depth - increase depth

Style Number	List Price
MOD-6	Add 10%

PRODUCT MODIFICATIONS
 modify width - outside of mod-1, mod-2

Style Number	List Price
MOD-3	Contact for pricing

Specifications

- Width modification outside of MOD-1 & MOD-2

Specifications

- Modify width down on tackboard, s veneer panel, or a overhead glassboard

Specifications

- Modify depth down (minimum depth for a unit with drawers is 21"D)

Notes
 - Ex. 24" to 21", 30" to 24", and 36" to 30"

Specifications

- Increase depth by no more than 6"

Notes
 - Ex. 24" to 30", 30" to 36", and 36" to 42"

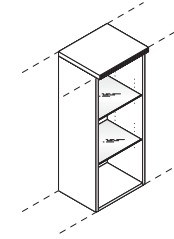
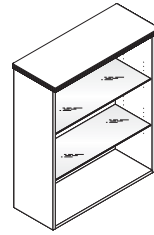
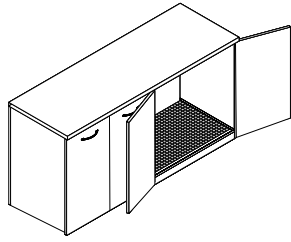

PRODUCT MODIFICATIONS
modify height

Style Number	List Price
MOD-7	Contact for pricing

REFRIGERATOR MODIFICATION
refrigerator cabinet modification

Style Number	List Price
REF01	205

SHELF MODIFICATIONS
glass shelves - tempered full width
26" - 35"

Style Number	List Price
26"W - 35"W x 14"D Shelf GS14F	90

SHELF MODIFICATIONS
tempered glass shelves for half
cabinet 17- 1/2" widths

Style Number	List Price
14-1/2"W - 17- 1/2"W x 14"D Shelf GS14H	70 ea.

Specifications

- Modify height of a unit

Specifications

- Open back cutout for venting
- Moisture sponge mat
- Contaminate ledge
- Contact customer service for maximum refrigerator size (Changes based on unit).

Notes
- Available on: 36" and 42" Storage Credenzas

Specifications

- Glass Shelves Replace Wood Shelf In Open Or Glass Door Cabinet. Also Order Interior Cabinet Lighting.

Specifications

- Glass Shelves Replace Wood Shelf In Open Or Glass Door Cabinet. Also Order Interior Cabinet Lighting.

Notes
- Replace only adjustable shelves between cabinet light and fixed lower wood shelf.

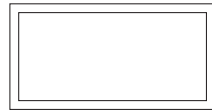
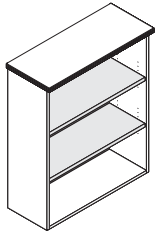

RECTANGLE INLAY

SHELF MODIFICATIONS

heavy duty solid wood bookcase
replacement shelves

Style Number	List Price
1" Wood Shelf 14" Deep S714F	80 ea.
1" Wood Shelf 24" Deep S714FX	160 ea.

SPECIALTY VENEER ACCENTS

rectangle inlay - ebony hardwood
inlay detail

Style Number	List Price
T10SA	935

Specifications

- 1" Solid Lumber Core Shelves Replace Standard 3/4" Plywood Adjustable And Fixed Shelves

Specifications

- 3/16" x 3/16" thick hardwood ebony inlay is handfitted and glued into routed top and sanded flush with surface
- Inlay is finished over with all finish steps

Notes

- Ebony inlay not recommended in: Koko Cherry

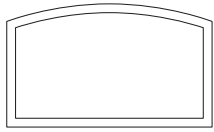

CURVED INLAY

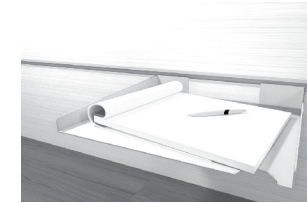
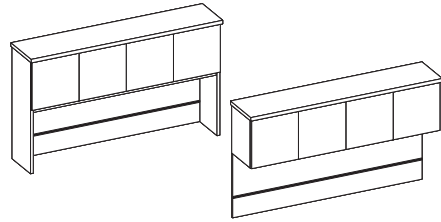

SPECIALTY VENEER ACCENTS
bowfront inlay - ebony hardwood
inlay detail

TOOL CHANNEL ACCESSORIES
recessed aluminum tool channel

TOOL CHANNEL ACCESSORIES
iphone holder

TOOL CHANNEL ACCESSORIES
large shelf

Style Number	List Price
T11SA	1035

Style Number	List Price
ATB02	5 per 1"W

Style Number	List Price
ATB31	125

Style Number	List Price
ATB35	135

Specifications

- 3/16" x 3/16" thick hardwood ebony inlay is handfitted and glued into routed top and sanded flush with surface
- Inlay is finished over with all finish steps

Notes
- Ebony inlay not recommended in: Koko Cherry

Specifications

- Anodized aluminum finish
- Fully recessed
- Finish matches anodized aluminum accessories
- Can be specified with fabric tack surface mounted above channel

Notes
- If using tool channel with wallhung overhead, a veneer panel must be specified.

Specifications

- For Console/Wall Hung Back Panels With Optional Tool Bar
- 18 Gauge Steel - Stamp Formed
- Silver Powdercoat Finish
- 5" x 3 -3/4"W
- Non-slip Neoprene pad

Specifications

- 12"W x 10"D

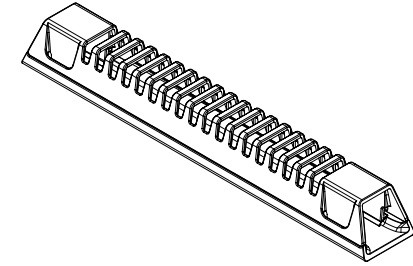
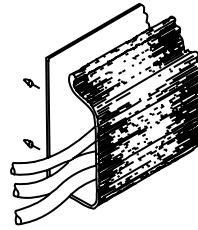

TOOL CHANNEL ACCESSORIES

pencil pen holder

TOOL CHANNEL ACCESSORIES

tablet holder

WIRE MANAGEMENT
horizontal j-channel wire
management raceway

WIRE MANAGEMENT
horizontal wire management raceway

Style Number	List Price
ATB38	120

Style Number	List Price
ATB30	145

Style Number	List Price
W1	80 Per 4' section

Style Number	List Price
W21	35

Specifications

- For Console/Wall Hung Back Panels With Optional Tool Bar
- 18 Gauge Steel - Stamp Formed
- Silver Powdercoat Finish
- 5"H x 4"W x 4"D

Specifications

- For Console/Wall Hung Back Panels With Optional Tool Bar
- 18 Gauge Steel - Stamp Formed
- Silver Powdercoat Finish
- 10" x 8"W
- Non-slip Neoprene pad

Specifications

- 4' section for field installation.
- The "J" shape black thermoplastic wire raceway may be added to specified worksurface tops to provide concealed channeling of wires to and from worksurface grommets. For use in open kneespace areas, raceway is attachable to top of back panel with pan head screws. Interior dimensions are 1" x 1- 1/2" providing ample storage for multiple wires and excess cable. Front of raceway flexes out for easy cord insertion.

- Notes
- Units w/ Wire Channel Standard.
 - Field Installation

Specifications

- 10"W x 1.5"D x 1.25"H
- Grey Wire Manager (10.5")
- Power and data cables can be discretely housed and managed with the W21 Gray Wire Manager. This can be mounted in any location to metal frame or underside of conference tables and runs cables through a 1" channel from power module to hollow steel legs. This keeps cables organized under the table top. Release clips make it simple to snap on and off the Wire Manager for easy organization and access after attached to the table

- Notes
- Field installed

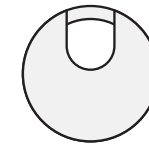
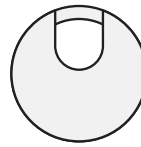

WIRE MANAGEMENT
horizontal u-channel wire management raceway

WIRE MANAGEMENT
coil wire manager

WIRE MANAGEMENT
standard location grommets - factory installed

WIRE MANAGEMENT
non-standard location grommets - factory installed

Style Number	List Price
W2A	80 Per 4' section

Style Number	List Price
W18	160

Style Number	List Price
Standard Location Grommet	
Black	
TM30	50
Silver	
TM31	50
Antique Brass	
TM33	50
White	
TM34	50

Style Number	List Price
Non-Standard Location Grommet	
Black	
TM30 -NS	95
Silver	
TM31 -NS	95
Antique Brass	
TM33 -NS	95
White	
TM34 -NS	95

Specifications

- 4' section for field installation.

Notes

- Units w/ Wire Channel Standard.
- Field Installation

Specifications

- Weighted Base, Table attachment plate
- 39- 1/2" Length
- Black

Notes

- Location

Specifications

- 1 -5/8" Metal Grommet

Notes

- *Units w/ Grommets Standard Are Noted Under Standard Features. Grommets Match Pull Finish - Standard (Unless Specified Otherwise)

Specifications

- 1 -5/8" Metal Grommet

Notes

- *Units w/ Grommets Standard Are Noted Under Standard Features. Grommets Match Pull Finish - Standard (Unless Specified Otherwise)



WIRE MANAGEMENT

black plastic vertical surface
grommets - factory installed

Style Number	List Price
Standard Location Grommet TM50-C	50
Non-Standard Location Grommet TM50-NS	95

Specifications

- 2 " Black Plastic Grommet

Notes
- Standard Location is Bottom Center

Aircharge wireless charging grommet

Style Number	List Price
ACWG WIRELESS GROMMET	\$195



Specifications

- > When used with GROVE Tables an additional \$350 LIST will apply for the special cutout required.
- > AirCharge offers a convenient way to charge any Qi compatible smartphone or device without the need to carry charging cables or find an available power outlet.
- > The Aircharge is powered by the latest Qi compliant IC offering reliable and efficient wireless charging in a convenient 3" grommet hub. Simply place your phone on the Aircharge and an LED will confirm pairing and begin wireless charging.
- > Recess: Efficient space conservation and quick access
- > Input: DC 5V (with included AC power adapter), DC 9V, 1.67A (with optional QC 2.0 power adapter)
- > Output: 5 watts Max. with DC 5V, 2A power adapter, 10 watts Max. with QC 2.0 power adapter
- > Qi V1.2 compliant IC
- > Charging distance: 6mm Max.

Available: All DARRAN collections



DARRAN

Cove power unit - non-linking

Style Number		List Price
PD-COVE PLUG		\$600
Non-linking version		

Specifications

- › Size 5.75"L x 2.5"W
- › (2) 15 Amp Receptacles and (2) USB charging ports
- › Surface Mount
- › 108" Cord
- › Standard Silver Finish, Available in White or Black Finish upon request
- › ETL Listed

Available: All DARRAN collections

Power & Data Options



Cove corded series

Style Number	List Price
 PD-COVE-PKO	\$800

Specifications

- > Size 9.5"L x 2.5"W x 3.18"D
- > When used with GROVE Tables an additional \$350 LIST will apply for the special cutout required.
- > (2) Power Receptacles, (2) 2.1 Amp USB charging ports and (1) Telecom Plate Knockout
- > Surface Mount
- > 108" Cord
- > Standard Silver Finish, Available in White or Black Finish upon request
- > ETL Listed

Available: All DARRAN collections

Telecom Plates

RJ45 (1)	\$55
RJ45 (2)	\$110
RJ45 (3)	\$165
USB (1)	\$70
USB (2)	\$140
RJ11/RJ45	\$110
RJ45/USB	\$125
RJ45/HDMI	\$210
HDMI/DVI	\$325
HDMI/USB	\$205
HDMI/VGA	\$240
VGA/MINI-STEREO	\$155
VGA/USB	\$175

This pod can have up to 1 total plates.
 *All telecom connectors sold separately.



DARRAN

Soba wire manager

Style Number	List Price
STARTER UNITS	
SCDW	\$200
White wire manager	
SCDB	\$200
Black wire manager	

Specifications

- > Dimensions: 9ft x 9in x 3.15in
- > Zips up, bundles and routes loose, messy cables into a single tube
- > Routes and guides cables behind desks, TVs, and anywhere cables tend to get messy
- > Accommodates large or small cables, up to three cables at once
- > Support channels, used to route cables, include powerful adhesive backing which allows easy attachment to surfaces.

Available: All DARRAN collections

Power & Data Options



VILLA Power unit - non-linking

Style Number	List Price
 VIL-C PLUG	\$515
Non-Linking	

Specifications

- > Size: Top Grommet 5.68"L X 3.39"W; Under Top 12"L x 3.13"W x 3.08"D
- > (2) Power receptacles; (2) USB charging ports and (1) Knockouts for RJ45 Data Ports
- > Surface Mount
- > 72" Cord (Longer cord available, contact Customer Service)
- > Standard Silver Finish, Black Finish available upon request
- > UL or ETL Certified

Available: All DARRAN collections, excludes Grove

RJ45 Knockout	
RJ45 (1)	\$55

