



Honey Price List

Effective April 1, 2024

Designed By Mark Müller and Chris Wright

Date	Page	Modification	Description
04.07.24		Upgraded Pricing	

Statement of Line
Features & Advantages1
Fabric & Leather Program3
Finishes | Specifications6
Metal Finishes | Specifications.....9
PET | Specifications.....10
Edges | Specifications11
Pulls12
Grommets13
Grain Direction14
Honey Wire Management15
Honey Workstation Dimensions.....17
Honey New York Power18
Honey West Coast Power19
Chicago Power.....20
Drawer Dimenisons.....21
Honey 120 degree Typical.....22-35
Honey Lounge.....36
120 degree Honey Panels.....37-45
Power Entry Box.....46
Tops.....47-48
Fixed Tables.....49-50
Privacy Screens.....51-53
Storage Credenzas.....54-55
Wardrobe Storage.....56-58
Mobile Pedestal.....59
Honey 120 Mobile Workstation.....60-61
120 Degree Return Top62-64
90 Degree Honey.....65
90 Degree Typical.....65-76
90 Degree Panels.....77-85
90 Degree Worksurfaces86-87
90 Degree Mobile Workstations88-89
90 Degree Privacy Screens90-92
Options93-101
Power I Specifications.....102-112

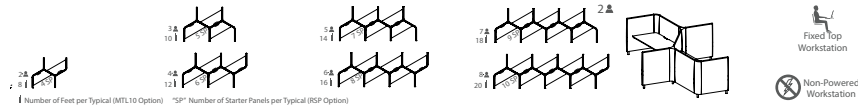

Page 22
Facing Diagonal Workstation Typical
Position 1 with Height Adjustable Worksurface

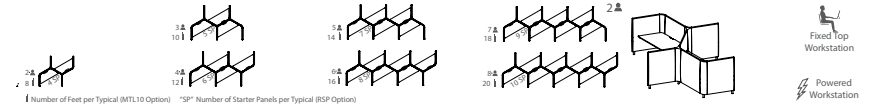

Page 23
Facing Diagonal Workstation Typical
Position 1 Desk with Power Fixed Worksurface

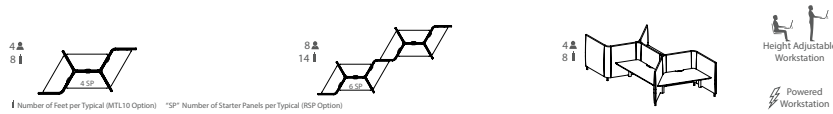

Page 24
Diamond Workstation Typical
Diamond Workstation with Height Adjustable Worksurface

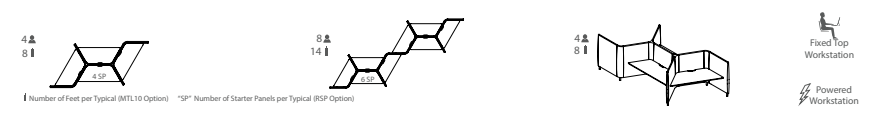

Page 25
Diamond Workstation Typical
Diamond Workstation with Power Fixed Worksurface

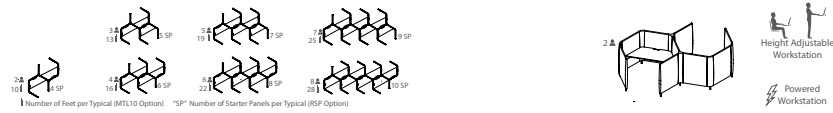

Page 26
Double Hexagon Workstation Typical
Position 2 Desk with Height Adjustable Worksurface

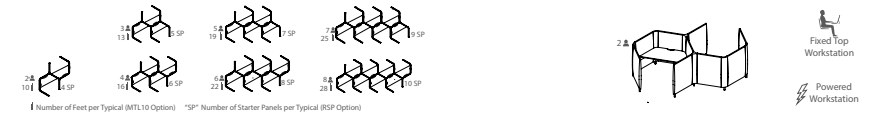

Page 27
Double Hexagon Workstation Typical
Position 2 Desk with Power Fixed Worksurface



Page 28
Hexagon Workstation Typical
Desk with Height Adjustable Worksurface

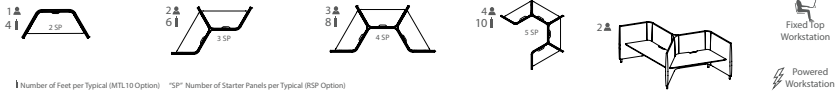

Page 29
Hexagon Workstation Typical
Desk with Power Fixed Worksurface



Page 30
Hexagon Workstation Typical
Five Person Workstation with Height Adjustable Worksurface



Page 31
Hexagon Workstation Typical
Five Person Workstation with Power Fixed Worksurface



Page 32
Hexagon Workstation Typical
Six Person Workstation with Fixed Worksurface



Page 33
Hexagon Workstation Typical
Six Person Workstation with Power Fixed Worksurface

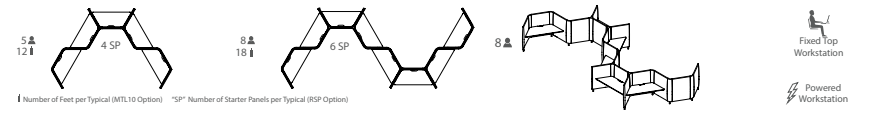

Page 34
S-Shaped Workstation Typical
Desk with Height Adjustable Worksurface

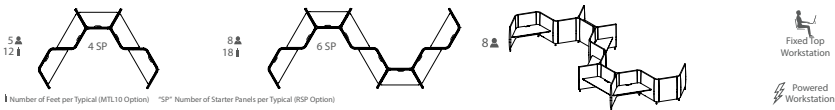

Page 35
S-Shaped Workstation Typical
Desk with Power Fixed Worksurface

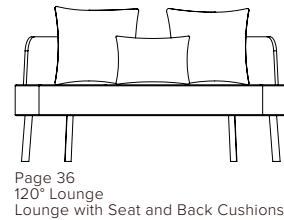

Page 36
120° Lounge
Lounge with Seat and Back Cushions

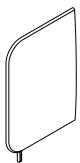

Page 37
120° Starter Panel
Round End

Statement of Line



Page 38
120° Starter Panel
Flat End

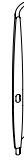

Page 39
120° Corner Panel Connector
Two Corner Panel



Page 40
120° Corner Panel Connector
Three Corner Panel



Page 41
In-Line Panel Connector
Straight Run Connector



Page 42
120° Adder Panel
No Power Access

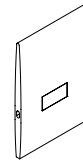

Page 43
120° Adder Access Panel
Single Sided Access

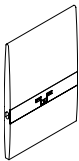

Page 44
120° Single Sided Power Panel
Power Panel

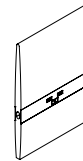

Page 45
120° Double Sided Power Panel
Power Panel

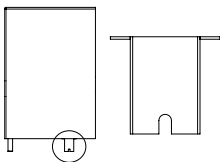

Page 46
Concealed Floor Power Infeed Cover
Power Cable Entry Box

Shown on
HNY3555SP889
Panel not included

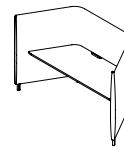

Panels
not included
Page 47
120° Worksurface Top
Worksurface with Fixed Top



Fixed Top
Worksurface



Panels
not included
Page 48
120° Worksurface Top
Worksurface with Height Adjustable Top

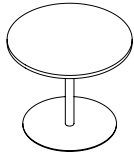

Page 50
Fixed Circular Table
Fixed Circular Table - Sitting Height



Top
not included

Page 52
120° Worksurface Privacy Screen
Worksurface Veneer Privacy Screen

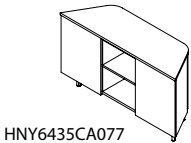

HNY6435CA077

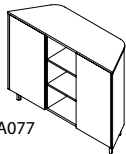

HNY6448CA077

Page 54
64" Wide Push-In Storage Credenza
Storage Credenza with Sliding Doors

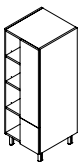

Page 56
Single Sided Open Storage Tower
Open Storage Tower with Left File / Wardrobe Access

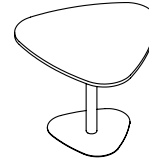

Page 49
Fixed Triangular Table
Fixed Triangular Table - Sitting Height

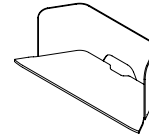

Top
not included

Page 51
120° Worksurface Privacy Screen
Worksurface PET Privacy Screen

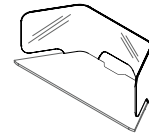

Top
not included

Page 53
120° Worksurface Privacy Screen
Worksurface Acrylic Privacy Screen

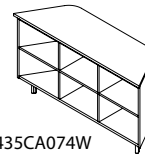

HNY6435CA074W



HNY6448CA074W

Page 55
120° Open Storage Credenza
Open Storage Credenza

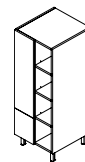

Page 57
Single Sided Open Storage Tower
Open Storage Tower with Right File / Wardrobe Access

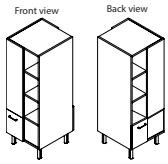

Page 58
Two Person Double Sided - Freestanding Shared Storage
All-in-One Cabinet-Double Sided



Page 60
Mobile Workstation Typical
Desk with Height Adjustable Worksurface

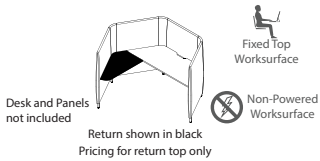

Page 62
120° Return Worksurface Top
Left Fixed Worksurface

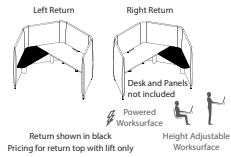

Page 64
120° Return Worksurface Top
Height Adjustable Top

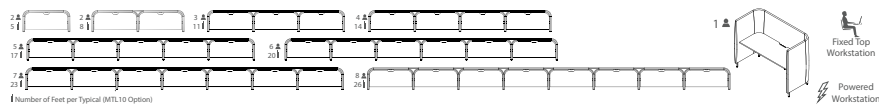

Page 66
Inline 90° Workstation Typical
Position 1 Desk with Power Fixed Worksurface

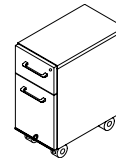

Page 59
Open Plan Mobile Pedestal
Mobile B/F Desk Pedestal With Casters



Page 61
Mobile Workstation Typical
Desk with Fixed Worksurface



Page 63
120° Return Worksurface Top
Right Fixed Worksurface

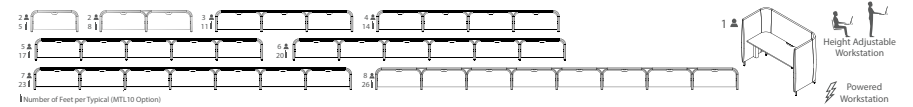

Page 65
Inline 90° Workstation Typical
Position 1 Desk with Height Adjustable Worksurface

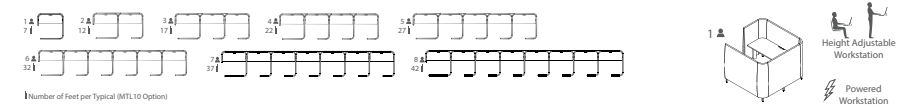

Page 67
Inline 90° Workstation Typical
Position 3 Desk with Height Adjustable Worksurface

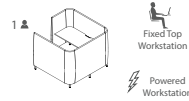
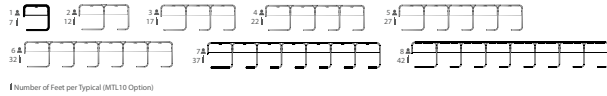

Page 68
Inline 90° Workstation Typical
Position 3 Desk with Power Fixed Worksurface

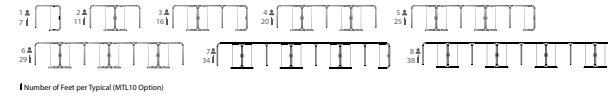

Page 69
Inline 90° Workstation Typical
Position 4 Desk with Height Adjustable Worksurface

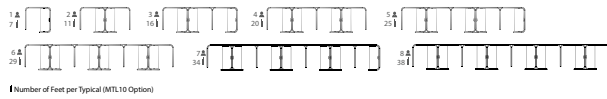

Page 70
Inline 90° Workstation Typical
Position 4 Desk with Power Fixed Worksurface

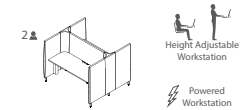

Page 71
Facing 90° Workstation Typical
Position 1 Desk with Height Adjustable Worksurface

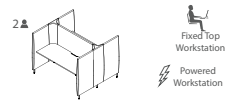
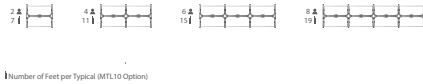

Page 72
Facing 90° Workstation Typical
Position 1 Desk with Fixed Power Worksurface

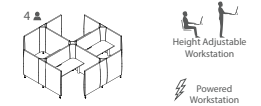
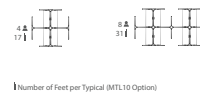

Page 73
Facing 90° Workstation Typical
Position 3 Desk with Height Adjustable Worksurface

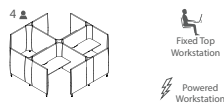
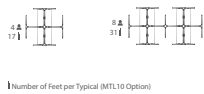

Page 74
Facing 90° Workstation Typical
Position 3 Desk with Fixed Power Worksurface

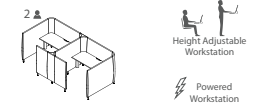
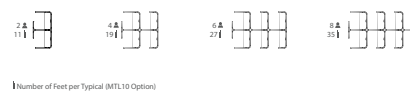

Page 75
Double 90° Workstation Typical
Position 1 Height Adjustable Desk



Number of Feet per Typical (MTL10 Option)

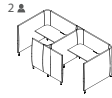

Page 76
Double 90° Workstation Typical
Position 1 Fixed Power Worksurface

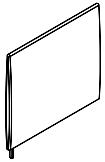

Page 78
90° Starter Panel
Flat End



Page 80
90° Corner Panel Connector
Three Way Corner Connector

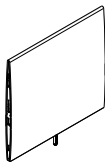

Page 82
90° Adder Panel
No Power Access



Page 77
90° Starter Panel
Flat End



Page 79
90° Corner Panel Connector
Two Way Corner Connector



Page 81
90° Corner Panel Connector
Four Way Corner Connector

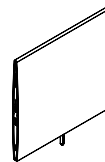

Page 83
90° Adder Panel
Single Sided Access

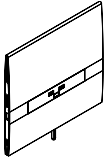

Page 84
90° Single Sided Power Panel
Power Panel

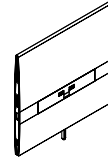

Page 85
90° Double Sided Power Panel
Power Panel

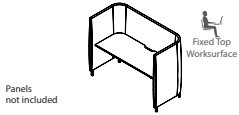

Page 86
90° Worksurface Top
Worksurface with Fixed Top



Page 87
90° Worksurface Top
Worksurface with Height Adjustable Top



Page 88
Mobile 90° Workstation Typical
Desk with Fixed Worksurface



Page 89
Mobile 90° Workstation Typical
Desk with Height Adjustable Worksurface

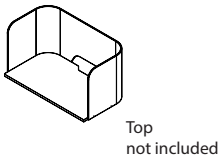

Page 90
90° Worksurface Privacy Screen
Worksurface PET Privacy Screen

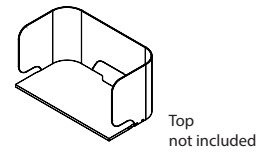

Page 91
90° Worksurface Privacy Screen
Worksurface Acrylic Privacy Screen

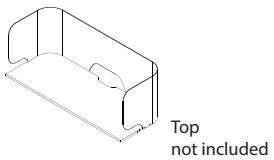

Page 92
90° Worksurface Privacy Screen
Worksurface Acrylic Privacy Screen

DARRAN®

Veneer tops

Veneer tops are 1" thick and comprised of 45-pound density MDF core with a balanced 3-ply construction. Veneer tops, screens, and lounge backs are standard in Quartered Walnut and Rift Cut White Oak Veneers that are slip-matched. Veneer tops are available in Flat or Cliff edge profile, with multiple banding options. Tops are finished in either 5-sheen matte finish or 40-sheen depending on finish selection.

HPL laminate tops

Honey high-pressure laminate tops are 1" thick and comprised of 45-pound density MDF core with a balanced 3-ply construction. Tops are available in Flat or Cliff edge profile, with multiple banding option.

TFL tops

Thermally Fused Laminate tops are 1-1/8" thick and fused to a 45-pound density substrate of the top for a durable surface. Tops are available in a Flat edge profile with multiple banding options.

Panel construction

Panels are composed of 3/4" and 1" birch plywood with tenon and groove construction that is secured with screws and glued. MDF trim pieces create soft rounded edges and beautiful contours. The frame is covered with 4.5mm PET acoustic panels for sound absorption. PET panels are composed of recycled content, are flame retardant, mold resistant and have zero emissions. Panels are standard elevated on 5" solid wood legs that feature 2" Glide for adjustment on uneven surfaces.

Case construction

Case pieces including pedestals, towers and credenzas are constructed of 3/4" thick particle board with 3-ply balanced construction. Pedestal and Cabinets feature dowel construction reinforced with steel bracket plates, wood cleats, screws and glue. Credenzas and Towers are elevated on 6" solid wood legs featuring 1" glide for adjustment on uneven surfaces.

Lounge construction

Lounge units are constructed from plywood with 2" thick bottom platform, 3/4" seat pan and 4" of high resiliency foam for comfort and durability. The honey Lounge back is a curved plywood core with veneer or laminate. Honey lounge consists of high resilient foam with a minimum of 2.5 density in seats and blown fiber cushions, further advances support and durability.

Lounge unit is elevated on 10.5" solid wood leg with oval shape to match panel stations.

Screens

Honey screens are available in Acrylic or Veneer over plywood. Acrylic is 1/4" thick and available in frosted, white, and black. Plywood screens are 1/2" thick and are available in Quartered Walnut and Rift Cut White Oak Veneer that runs horizontally on the screen. Screens secure to the

Honey Features & Advantages

underside of the worksurfaces with an L bracket. Screens feature a center cutout to allow clip-on power pods and easy wire management to the MGT: Wire Tray below the worksurface. The screen is 24" tall for added privacy; the screen's unique curved wings mimic the worksurface top creating a barrier between users and work area to focus.

Cleaning wood & laminate

In addition to regular dusting, give your furniture an occasional cleaning in accordance with our cleaning instructions. DARRAN wood and laminate products can be cleaned with a soft cloth and a mild soap and water mixture. Use approximately 32 oz of water mixed with one tablespoon of dish soap, always wiping with the grain. Dry with a soft cloth, going with the grain, to avoid spotting or streaking.

Wood products should be waxed periodically using a non-wax liquid; please do not use any waxy polish or cleaner. Interior of drawers may also be cleaned with mild soap and water mixture, or any household cleaner that is not petroleum or thinner-based.

Suspensions

All cabinets and mobile pedestals utilize cold rolled steel zinc plated high-grade drawer suspensions. All suspensions are warranted for the lifetime of the product. Box and File drawers are full extension, featuring steel ball bearings for a smoother quieter range of motion with soft close operation and are rated 100lbs.

Filing

Honey features a highly durable black plastic extrusion that is securely fastened into a route on top of the drawer to support hanging files. An adjustable crossbar is provided for all file drawers that enables legal/letter filing front to back or side-to-side based on the drawer size.

Locks

Locks are optional on pedestals and doors. Each drawer pedestal is independently locked. Lock plugs are factory or field installed.

Keying

Keying is available either factory or field installed. Factory installed keying offers two options: random or designated. When the random keying option is selected an arbitrary key number will be assigned to the unit. When the designated keying option is selected a key number must be specified between 101 and 110. Higher numbers may be specified if noted on the purchase order and may be factory or field installed. Black and silver face lock have silver keys.

Wire management

Wire management capabilities include standard and optional worksurface grommets. Specify W21 under surface wire channels for organization and management of all communication wires and cords. Sold separately to conceal wire under worksurfaces. Top feature a cutout in the back and unique curved wings allowing for clip on modules or easy wire management to the power tray below the worksurface.

Grommets

Metal grommets are provided to match the drawer pull selection. Metal grommets are available in black, silver or white. Must specify standard or non-standard location. TM50 Black plastic grommets are available as an option for vertical applications.

Seating & fabric leather program

DARRAN has partnered with some of the most prestigious fabric suppliers of the office furniture industry to bring you quality fabrics that are engaging designs, environmentally friendly and durable for years to come. The majority of fabrics we have graded-in are in heavy supply making it most likely available on our Quickship however, we cannot guarantee stock. If you do not see the fabric you wish to include in a project, please contact Customer Service to see if this pattern can be graded in at 800.334.7891.

Panel fabric program

ALL COM fabric must be preapproved by DARRAN. Leather fabric program is not approved on panels. Due to stretching and sagging textile content for panels shouldnt exceed a combined 50% cotton, linen, nylon and/or rayon is not recommended. Panel fabrics are required to have flame certificates that meet ASTM E84 Adhered (for power panels) and Unadhered (for panels). DARRAN does not accept responsibility of collecting flame certificates for COM.

Fabrics & leathers

Please visit our Seating Fabrics page at darran.com/textilesleather

Camira
www.camirafabrics.com
800.334.789

Wollsdorf
www.wollsdorf.com
336.884.5005

CFStinson
www.cfstinson.com
800.841.6279

Green Hides
www.greenhides.com
336.315.9720

DesignTex
www.designtex.com
800.797.4949

Maharam
www.maharam.com
800.645.3943

Momentum Textiles
www.momentumtextiles.com
800.366.6839

Ultrafabrics
www.ultrafabricsinc.com
800.334.7891

Application instructions must be specified on the purchase order or COM / COL submission form. In the absence of application instructions, DARRAN will apply materials accordingly.

CAL117

All DARRAN seating products conform to California Technical Bulletin 117 as a minimum standard.

CAL133

To meet the California Technical Bulletin 133 flammability regulation, a combination of proper materials must be used to pass, as it tests the fire resistance of a finished product. Flame resistant fabric, a fire blocker material and special foam must be used to pass CAL133 fire codes.

Testing is available for all seating products with the following fees and considerations:

- If laboratory certification is not required, any style can be manufactured to comply with California Technical Bulletin 133 for \$75 list per yard required. (Customer's Own Materials must factor in additional yardage requirements based on repeat.)
- The purchase order must clearly indicate the requirement of California Technical Bulletin 133
- If laboratory California Technical Bulletin 133 certification is required, the cost of testing a chair is \$820 NET, plus the cost of the chair and covering material.
- An additional lead time of 4 to 6 weeks is required for testing for CAL133.
- Once testing is completed, we will provide a certification letter specific to the sample tested for CAL133.
- DARRAN's manufacturing procedures for California TB 133 compliance are based on the testing of representative style with specific fabrics. Please contact Customer Service for an updated list of tested models.
- A copy of test certification is available upon request.

Combination fabrics

DARRAN is pleased to offer customers the design freedom of combination fabrics. When using fabric, vinyl or leather combinations, pricing will be as follows:

- When combining two materials of the same grade, pricing will be specified grade + 5%.
- If combining two materials of different grades or leather/ fabric combination, use the highest grade/price + 5%.
- If using COM or COL, pricing will be COM or COL + 5%. If both COM + COL are used in combination, use COL + 5%

COM/COL ordering instructions

Please complete the COM Submission Form prior to ordering the fabric from the supplier. All COM fabrics must be approved prior to order submission. Please refer to our website or contact DARRAN Seating Customer Service for an updated list of preapproved COM fabrics. Application instructions must be specified on the purchase order or COM/COL approval form. In the absence of application instructions, DARRAN will apply materials in the best manner and cannot be held responsible for tailoring or application objections after upholstering. COM orders will be scheduled for production after receipt of the material. Packages must be clearly marked and the fabric must be first quality, continuous yardage.

COM/COL yardage requirements

The yardage requirements stated in this price list for each style are calculated using 54" wide, non-directional fabrics. For fabrics with a different width or for patterns with repeats, please refer to the below chart to calculate the additional percent of fabric required:

Fabric Width	Plain Fabric	2" - 14" Repeat	15" - 19" Repeat	20" - 27" Repeat	28" - 36" Repeat
54"	0	15%	20%	25%	30%
53"	6%	19%	24%	28%	36%
52"	13%	23%	28%	33%	38%
51"	19%	26%	31%	36%	41%
50"	25%	30%	35%	40%	45%
49"	30%	35%	40%	45%	50%
48"	35%	40%	45%	50%	55%
47"	45%	50%	55%	58%	65%

DARRAN®

NOTE: Prior To Completion Of This Form, Please Refer To Our Graded In Materials Program For Preapproved Fabrics/Leathers.

COM/COL Approval

DARRAN Furniture Industries
2402 Shore Street, High Point, NC 27263
ATTN: Seating Division / COM/COL Approval
TAG: DARRAN Quote Number

Shipping approved COM/COL materials

DARRAN Furniture Industries
2402 Shore Street, High Point, NC 27263
ATTN: Seating Division / COM/COL Approval
TAG: DARRAN Quote Number

Please complete this form, attach a 6"x 6" sample and mail to the COM/COL APPROVAL address shown above.
This form can also be downloaded from our website at www.darran.com/leathers OR www.darran.com/fabrics

Quote # _____

Dealer's Name _____

Contact _____

Address _____

Telephone _____

Email _____

Chair Style _____

Manufacturer _____

Pattern Name _____

Pattern Color _____

Content _____

Repeat _____

Please specify any special requirements and check the application above.

Honey Fabric & Leather Program

ATTACH 6" X 6" FABRIC/LEATHER SAMPLE HERE

NOTE
Actual Fabric/Leather samples needed instead of digital images. If digital images are sent in lieu of samples, DARRAN will only verify the pattern and will not take responsibility for color variances that cannot be verified due to printing limitations.

In the absence of application instructions, DARRAN will apply the material in the best manner and cannot be held responsible for tailoring or application objections after upholstering.

Unless otherwise instructed on the purchase order, excess COM materials will be recycled at the discretion of DARRAN after six months of the original product ship date.

The COM approval solely pertains to the application of the fabric onto the specified DARRAN seating product. DARRAN's approval or acceptance does not constitute any responsibility or warranty to the overall appearance, durability, flammability, defects, dye lot variations or colorfastness of the COM. It is the customer's responsibility to ensure the COM meets CAL 117 compliance and are first quality continuous goods.

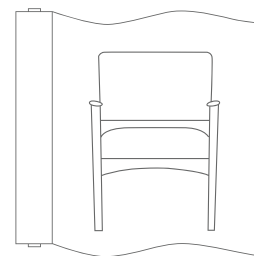

RAILROAD

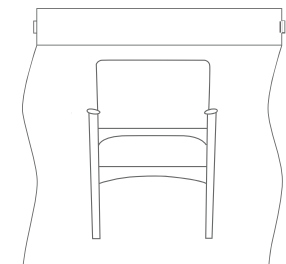

SETUP

MATTE 5% SHEEN VENEER

Specify LST-25 to change matte 5% sheen to satin 25% sheen - N/C.

VENEER FINISHES



WAM Alabaster Maple



WAF Narvik Ash



WCM Clear Maple



WLF Lofty Oak



WWW Weathered Walnut



WFO Fawn Cypress



WNO Natural Oak



WEF Neo Walnut



WGW Gunstock Walnut



WOW Clear Walnut



WSW Smokey Walnut



WMF Mocha Oak



WNW Natural Walnut



WEW Executive Walnut



WBW Henna Walnut



WEC Ebony

PREMIUM VENEER



WLO Lofty Oak



WFO Fawn Cypress



WNO Natural Oak



TOBW Organic Brown



TSTV Studio Teak



TSLV Skyline Walnut



WMO Mocha Oak



Welltech Finish delivers a superior furniture coating with exceptional performance that can withstand stringent cleaning agents and possesses unparalleled durability, allowing DARRAN to provide lasting, sustainable products to our customers.

HIGH PRESSURE LAMINATES

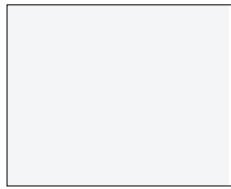

GWL Designer White

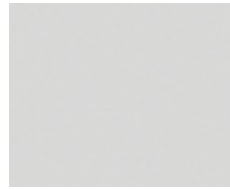

LF03 Folkstone



LW04 Phantom Pearl



LW05 Phantom Ecrú



GAM Alabaster Maple



GNA Narvik Ash



GCM Clear Maple



LW02 Fawn Cypress



LW01 Neo Walnut



GSTV Studio Teak



LW06 Phantom Cocoa

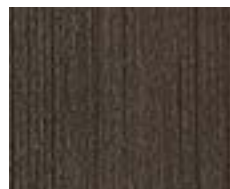

GSLV Skyline Walnut



GNW Natural Walnut

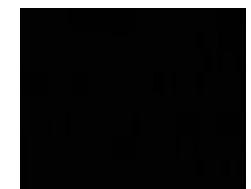

GEC Ebony

TFL LAMINATES

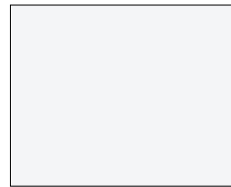

MWL Designer White



MNA Narvik Ash



MWW Weathered Walnut



MTW Studio Teak



MGW Gunstock Walnut



MSW Skyline Walnut



MEC Ebony

PAINTS



* Flagstone (PM11)



*Artifact Gray (PM12)

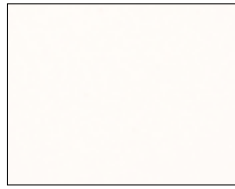

*Boucle White (PM13)



*Warm Gray (PM14)



*Gold Umber (PM15)



*London Gray (PM16)



*Golden Sand (PM17)



*Nutmeg (PM18)



*Redwood (PM19)



*Moonless Night (PM20)



*Pure White (PM21)



*Cloudburst (PM22)



*Maritime (PM23)



Designer White (WWP)



Cyberspace (PCS-SW-7076)



Evergreen Fog (PEF-SW 9131)

FENIX LAMINATES

* Contrasting Tops and Chassis are available for additional charge. Contact Customer Service for Quote



Skyline Steel (PSS-SW 1015)



LFBK Bianco Kos

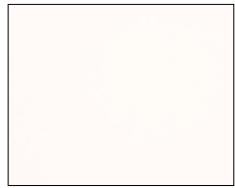

LFBM Bianco Male



LFB A Beige Arizona

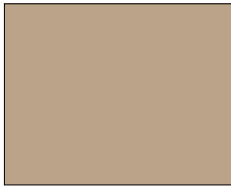

LFB L Beige Luxor



LFG E Gringo EfestO



LFVC Verde Comodoro



LFCW Castoro Ottawa



LFLG Gringo Londra



LFCO Cacao Orinoco



LFRJ Roosoo Jaipur



LFG B Gringo Bromo



LFB F Blue Fes



LFNI Nero Ingo

The benefits of FENIX® surface material:

- Soft to the touch
- Extremely matte
- Resists fingerprints
- Highly resistant to scratches, abrasion, acid-based solvents and household cleaners

Height adjustable columns are standard in MFW White. MFB Black is optional when specified.

Height Adjustable Mechanism Metal Finishes

STANDARD

OPTIONAL

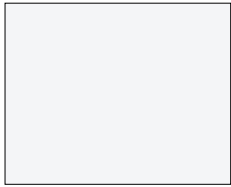

MFW White
Satin Finish
(Standard)



MFB Black
Satin Finish
(Optional - N/C)

Feet, Table Base, Wire Tray and Bracket Metal Finishes

POWDERCOATS

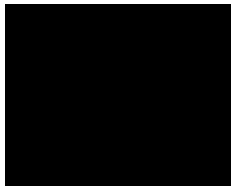

Black
Standard

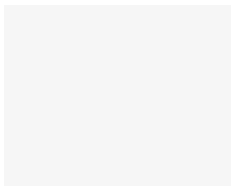

MFW White
Premium



MFCH Chrome
Premium

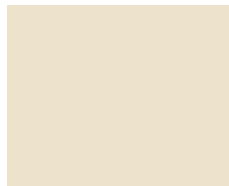

MFOS Oyster
Premium

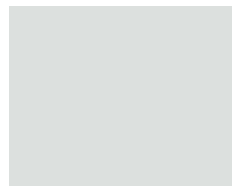

MFG Grey
Premium

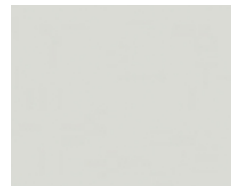

MFGW Gray White
Premium



MFS Silver
Premium



MFGB Grey Beige
Premium



MFSD Satin Bronze
Premium



MFEG Graphite Gray
Premium



MFNA Navy
Premium



MFMB Matte Black
Premium

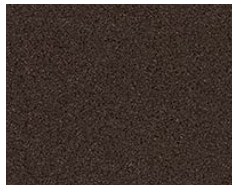

MFDB Dark Bronze
Premium



MFGM Gold
Premium

PET felt screens are available in the colors below.



Light Gray
3



Deep Blue
09



Dark Gray
17



Pure Gray
34



Berry Red
36



Ivory
44



Emerald
47



Smokey Beige
53



Heathered Granite
71



Heathered Oatmeal
75

Standard profile

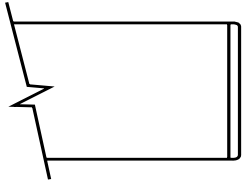

Flat-1

"W" "G"
 "W" 3mm Hardwood Band
 "G" Matching PVC Band

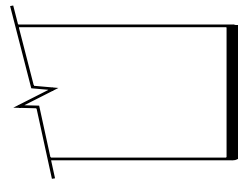

Flat-2

"W" "G" "M"
 2mm Black
 PVC Band

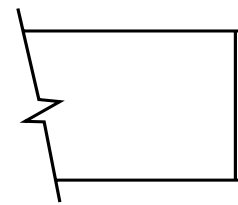

Flat-3

"W" "G" "M"
 2mm White
 PVC Band

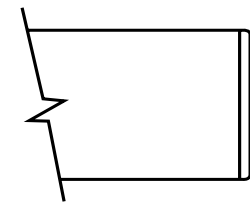

Flat-4

"M"
 2mm Matching PVC Band

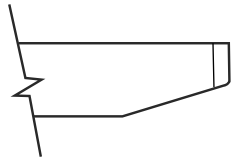

Cliff-1

"W" "G"
 "W" 3mm Hardwood Band
 "G" Matching PVC Band
 Cutback is finished to match top



Cliff-2

"W" "G"
 2mm Black PVC Band
 Cutback is finished to match top

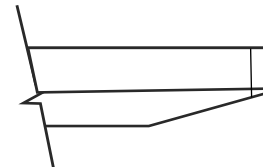

Cliff-3

"W" "G"
 2mm White PVC Band
 Cutback is finished to match top

Honey pulls come standard in PL-506 gloss white. Optional pulls available when specified.



PL - 506 Gloss White (Standard)
PL - 507 Matte Chrome



PL - 406 Gloss White
PL - 407 Matte Chrome



PL-115 Matte Black
PL-116 Matte Nickel

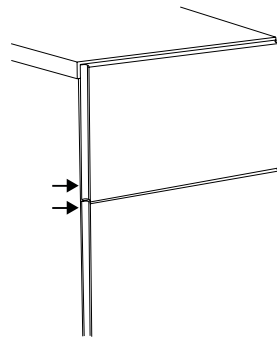

finger pull side view
(Not available on TFL products)

TM60
Black
1-5/8" Dia.



Grommets (vertical surface)

Standard Location - \$50 ea.
- Black Plastic Vertical Surface: TM60-C (Bottom Center)

Non-Standard Location - \$95 ea.
- Black Plastic Vertical Surface: TM60-NS

Grain direction

All top parts, storage credenzas, pedestals and towers come with horizontal grain.

Worksurfaces

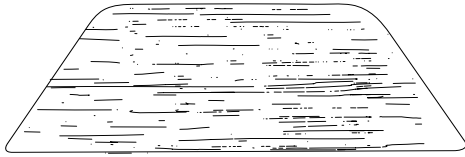

Desk/Credenza

Honey panels feature an integrated power system that daisy chains through panels to power workstations. The system features 8 wires, 4 circuits, (1 dedicated circuit), 20 amps each. Hardwired systems feature (13) duplex receptacles per circuit, (52) 15 amp duplex receptacles per power infeed maximum. The Honey power system is UL Listed as a manufactured wiring system.

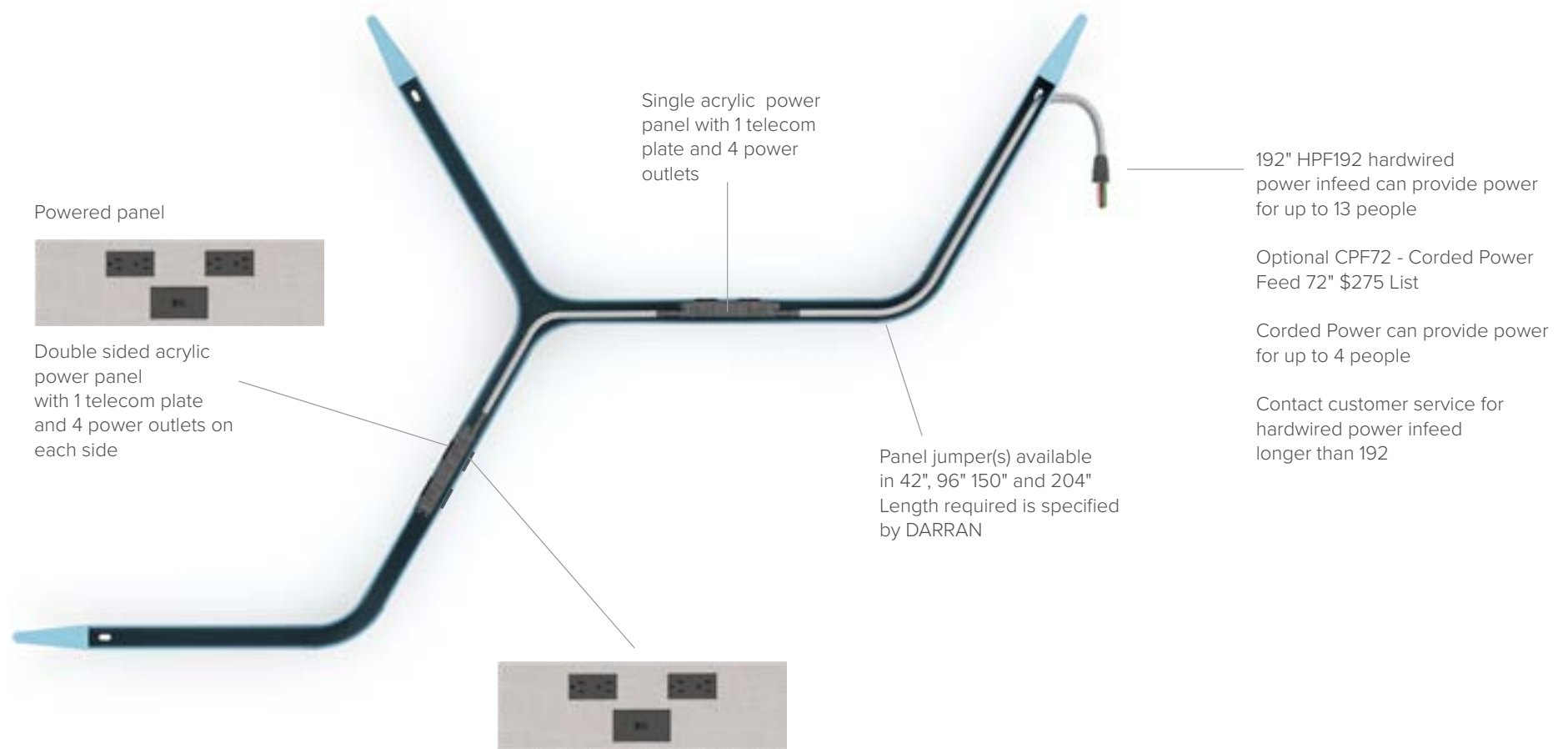

Honey cutout

Honey worksurfaces feature a standard T75 wire management cutout to drop wires below the worksurface.

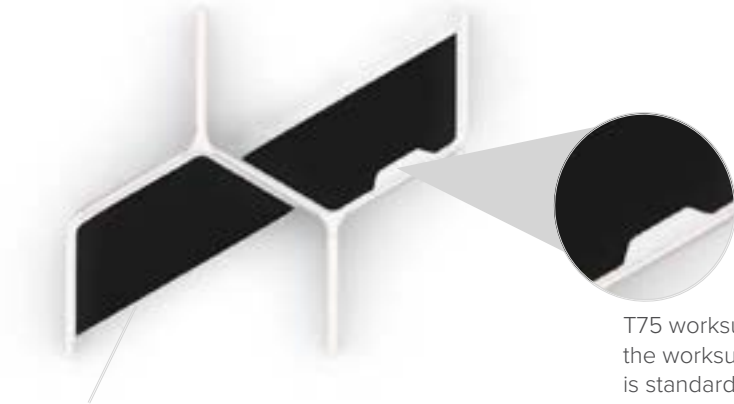

T75D option is available to delete cutout on worksurfaces at no charge. Please specify when ordering.

T75 worksurface cutout to drop wires below the worksurface to power access. Wire cutout is standard on all typicals.

Honey T75 dimensions

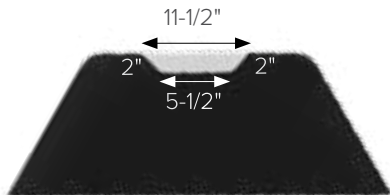

Panel workstation dimensions

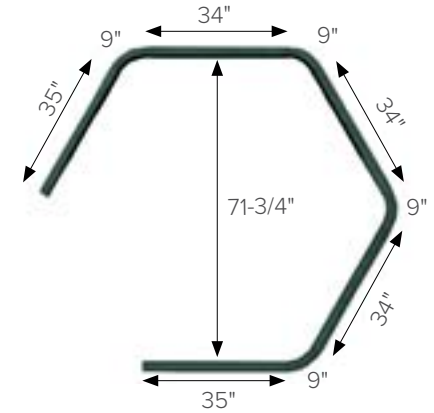
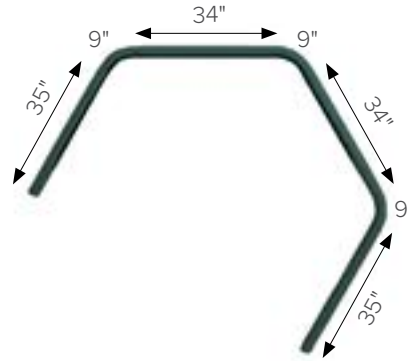
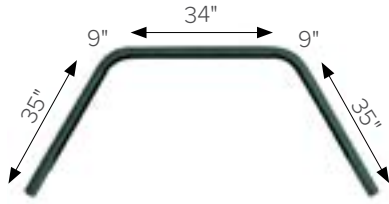

Height adjustable worksurface dimensions

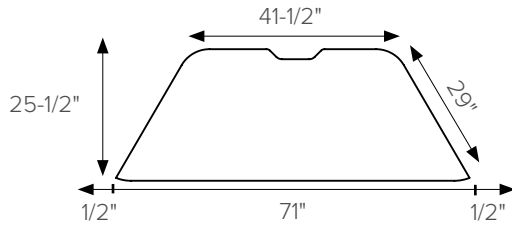

72" Height Adjustable Worksurface

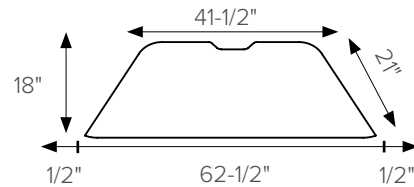

63-1/2" Height Adjustable Worksurface

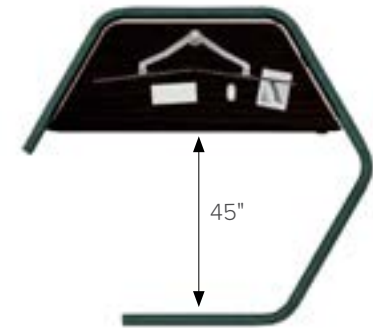

Fixed worksurface dimensions

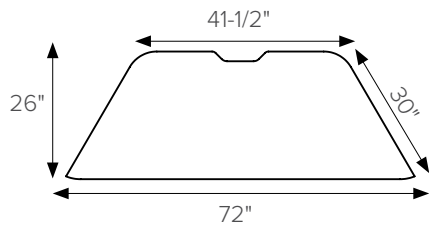

72" Fixed Worksurface

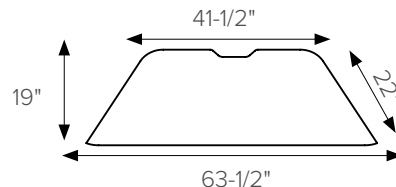

63-1/2" Fixed Height Worksurface

Honey workstations can be specified to meet New York electrical requirements. A flexible infeed, junction box and removable acrylic cover is included when specifying New York Power. The infeed and junction box are required to be on the Starter Panel at the first workstation next to a Single or Double Sided Power Panel. The customer will need to specify if the removable cover will need to be on the inside or outside of the workstation Starter Panel. NYPE: New York Power - \$425 list.

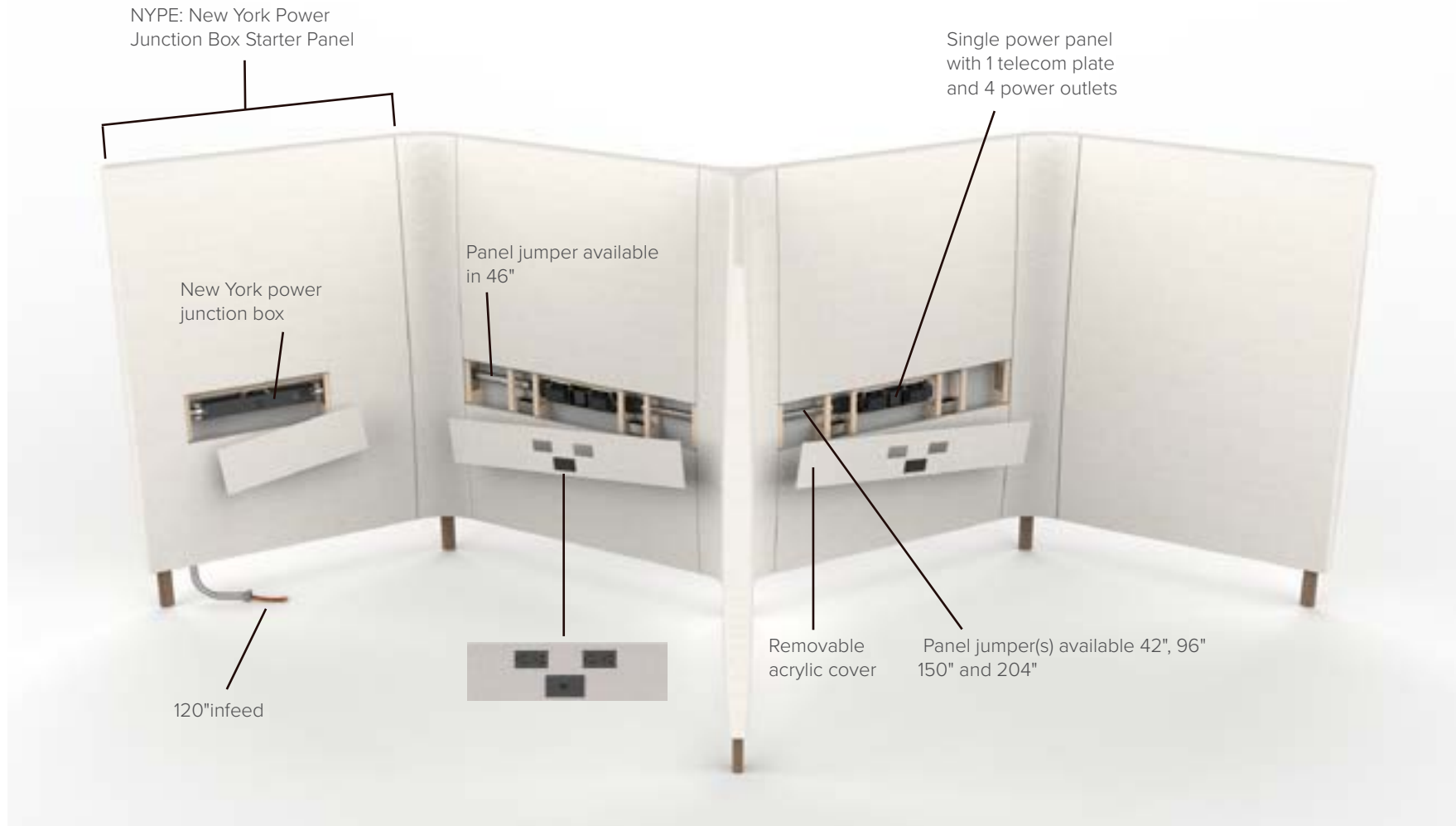

Rounded Starter Panels are not available with NYPE: New York Power Entry option.

*Please check with general contractor to see if NYPE: New York Power option is required.

Honey workstations can be specified to meet West Coast electrical requirements. A Circuitrac energy management system and flexible infeed is included and must be specifying on a Starter Panel at the first workstation next to a Single or Double Sided Power Panel. The customer will need to specify if the removable cover will need to be on the inside or outside of the workstation Starter Panel. WCPE: West Coast Power - \$2,695.

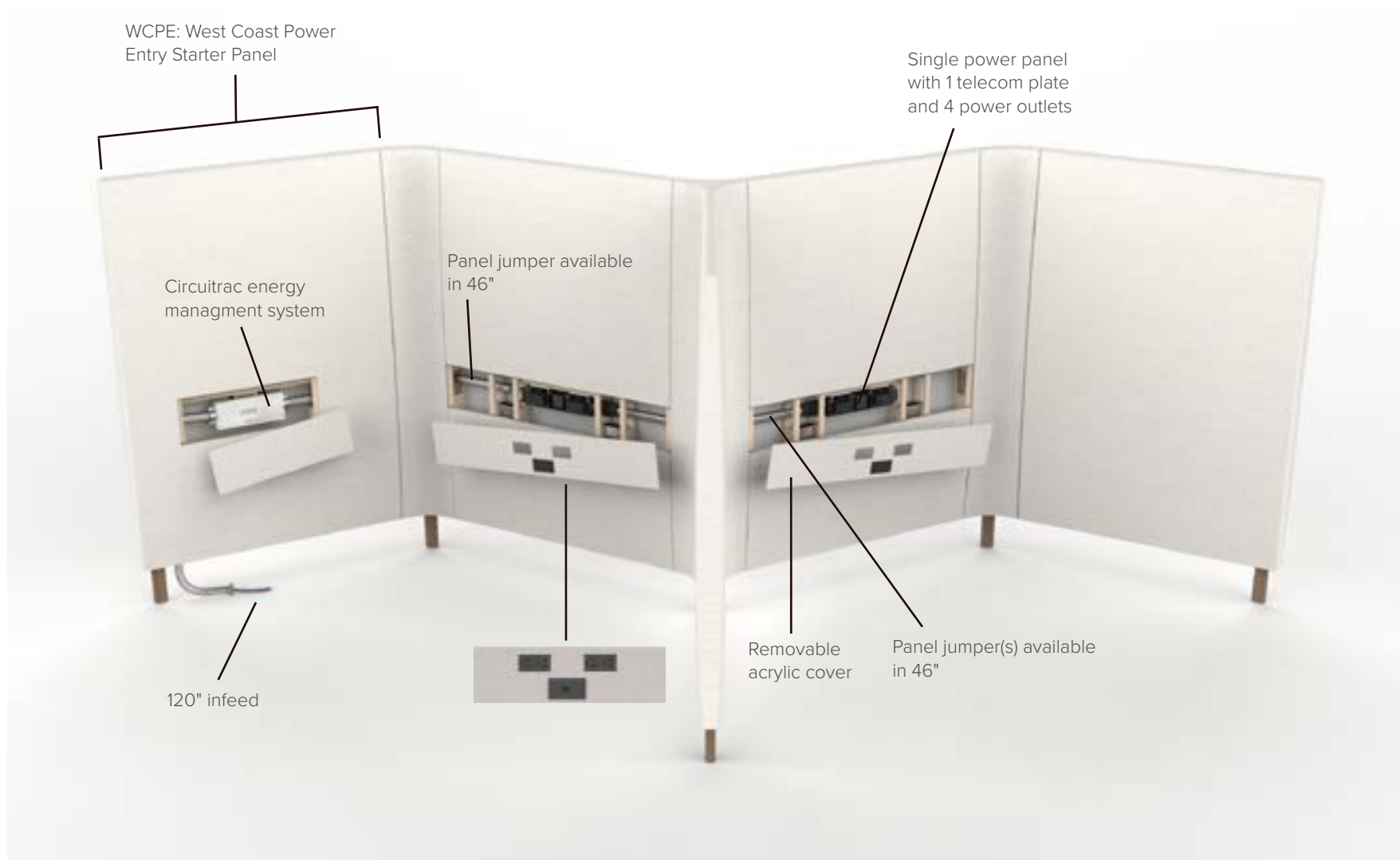

Rounded Starter Panels are not available with WCPE: West Coast Power option.

*Please check with general contractor to see if WCPE: West Coast Power option is required.

Honey workstations can be specified with a Single or Double Sided Power Panel to meet Chicago electrical requirements. Chicago Power Panels include an electrical box inside Power Panels for a local electrician to wire receptacles and connectors. CSSPP: Single Sided Power Panel - \$25. CDSPP: Double Sided Power Panel - \$50.

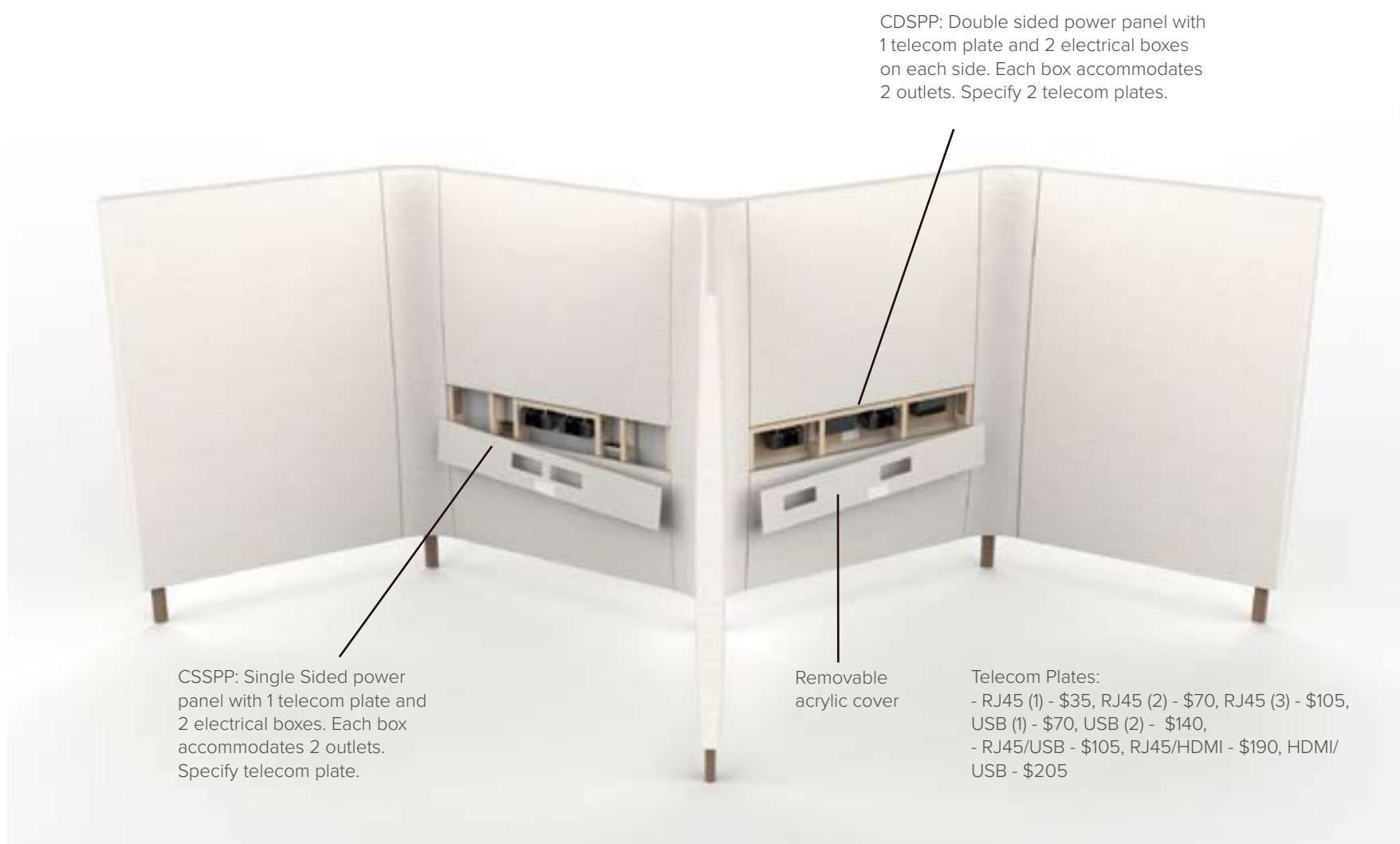

CDSPP: Double sided power panel with 1 telecom plate and 2 electrical boxes on each side. Each box accommodates 2 outlets. Specify 2 telecom plates.

CSSPP: Single Sided power panel with 1 telecom plate and 2 electrical boxes. Each box accommodates 2 outlets. Specify telecom plate.

Removable acrylic cover

Telecom Plates:
 - RJ45 (1) - \$35, RJ45 (2) - \$70, RJ45 (3) - \$105,
 USB (1) - \$70, USB (2) - \$140,
 - RJ45/USB - \$105, RJ45/HDMI - \$190, HDMI/
 USB - \$205

*Please check with general contractor to see if Chicago Power is required.

Interior drawer dimensions

UNIT DEPTH	DRAWER TYPE	OVERALL DIMENSIONS			INTERIOR DRAWER DIMENSIONS			NOTES
		W	D	H	W	D	H	
15-5/8" Letter	18" Box	13-1/8	16-1/16	4	12-1/8	15-1/16	3-7/16	Units less than 72"
	18" File	13-1/8	16-1/16	9-13/16	12-1/8	15-1/16	9-5/16	Units less than 72"
	10" Box	7-1/2	16-1/16	4	6-1/2	15-1/16	3-7/16	
	10" File	7-1/2	16-1/16	9-13/16	6-1/2	15-1/16	9-5/16	

Filing reference

Filing for 10" depth units

7-1/2" Wide File Drawer - 16 1/16" Deep



Letter Side to Side

Mobile Pedestal and Tower

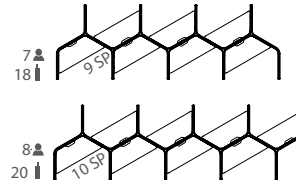
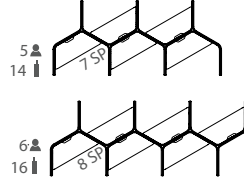
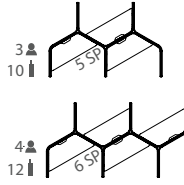

2

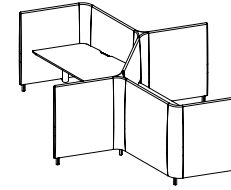

Height Adjustable Workstation

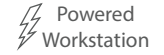

Powered Workstation

Number of Feet per Typical (MTL10 Option) "SP" Number of Starter Panels per Typical (RSP Option)

1 Select Model

Weight	Standard Veneer Top Upholstered Panels - COM\$	Premium Veneer Top Upholstered Panels - COM\$
340 x 101 x 55	71 8 HNY340101HA573W 61697	"P" Option N/A
303 x 101 x 55	64 7 HNY303101HA573W 54439	"P" Option N/A
265 x 101 x 55	56 6 HNY265101HA573W 47454	"P" Option N/A
228 x 101 x 55	49 5 HNY228101HA573W 40196	"P" Option N/A
191 x 101 x 55	41 4 HNY191101HA573W 33211	"P" Option N/A
153 x 101 x 55	34 3 HNY153101HA573W 25953	"P" Option N/A
116 x 101 x 55	26 2 HNY116101HA573W 18968	"P" Option N/A

[Click Here for Graded in Pricing](#)

2 Select Finish

Click to view finishes

3 Select Feet Finish

4 Select Edge

Click to view details

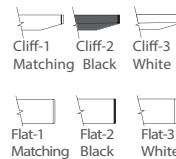
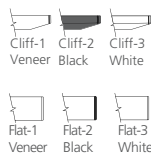

High Pressure Laminate Top Upholstered Panels - COM\$

HNY340101HA573G	60089
HNY303101HA573G	53032
HNY265101HA573G	46248
HNY228101HA573G	39191
HNY191101HA573G	32407
HNY153101HA573G	25350
HNY116101HA573G	18566

Click to view finishes

Thermally Fused Laminate Top Upholstered Panels - COM\$

HNY340101HA573M	57033
HNY303101HA573M	50358
HNY265101HA573M	43956
HNY228101HA573M	37281
HNY191101HA573M	30879
HNY153101HA573M	24204
HNY116101HA573M	17802

Click to view finishes

[Click here to view statement of line](#)

Product Features

- 5" Solid wood feet - oval shape, ships KD
- 4 Power outlets with 1 telecom plate, see options below for telecom plate
- Adjustable height from 27" to 47.5" with a maximum weight capacity of 275 lbs. Lift standard in MFW White, optional MFB Black
- HNY7125WT163 Height Adjustable worksurfaces are included
- Wire management tray attaches to worksurface top, standard in MFW White, see premium Metal Finish for options
- T75 worksurface wire cutout is standard on all worksurfaces.(T75D: Delete cutout is optional)

Notes

- 1" Gap between worksurface and panels to drop wires below worksurface
- Metal parts include 5 year warranty
- Programmable height adjustable mechanism, motor includes 2 year warranty

Options

Accessories

- K28: Articulating Keyboard w/ Mouse - \$390
- K31-SK: Center drawer w/ skirt - \$310
- K31: Center drawer w/o skirt - \$205

Concealed Floor Power Infeed Cover

- PCEB: White Metal Finish concealed floor power infeed cover - \$150

Delete Top and Wire Tray

- DHAT: Delete height adjustable top. Deduct \$3845 Veneer(W), \$3644 High Pressure Laminate(G), \$3262 Thermally Fused Laminate(M) per top

Metal Feet

- MTL10: Replace solid wood feet with metal feet, standard MFW White - \$55 ea

Premium Metal Finish

- See Front of Price List for Premium Metal Finish Options
- Premium Metal Finish for WMT Wire Management Tray - \$75 ea
- Premium Metal Finish for MTL10 Metal Feet - \$20 ea
- Premium Metal Finish for PCEB Concealed Floor Power Infeed Cover - \$35

Starter Panel

- RSP: Substitute round starter panel in place of flat starter panel. Must substitute all starters, priced per starter panel - \$83 each. See HNY3555SP888

Telecom Plates

- Each power unit has 1 plate. All telecom connectors sold separately.
- RJ45 (1) - \$55, RJ45 (2) - \$110, RJ45 (3) - \$165, USB (1) - \$70, USB (2) - \$140, RJ45/USB - \$125, RJ45/HDMI - \$210, HDMI/USB - \$205

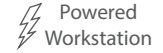
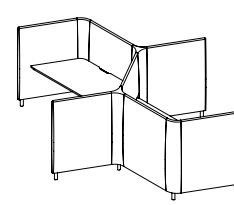
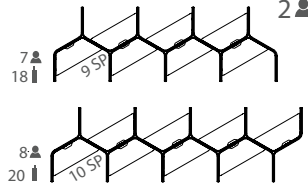
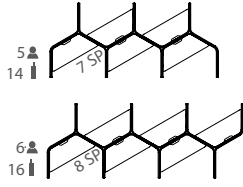
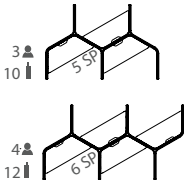
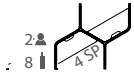

Number of Feet per Typical (MTL10 Option) "SP" Number of Starter Panels per Typical (RSP Option)

1 Select Model

w" x d" x h"	Weight	Standard Veneer Top Upholstered Panels - COM\$	Premium Veneer Top Upholstered Panels - COM\$
340 x 101 x 55	71	8 HNY340101FP573W 41961	"P" Option N/A
303 x 101 x 55	64	7 HNY303101FP573W 37170	"P" Option N/A
265 x 101 x 55	56	6 HNY265101FP573W 32652	"P" Option N/A
228 x 101 x 55	49	5 HNY228101FP573W 27861	"P" Option N/A
191 x 101 x 55	41	4 HNY191101FP573W 23343	"P" Option N/A
153 x 101 x 55	34	3 HNY153101FP573W 18552	"P" Option N/A
116 x 101 x 55	26	2 HNY116101FP573W 14034	"P" Option N/A

[Click Here for Graded in Pricing](#)

2 Select Finish

[Click to view finishes](#)

3 Select Feet Finish

4 Select Edge

[Click to view details](#)

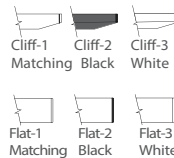
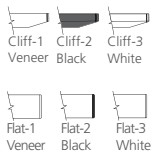

[Click here to view statement of line](#)

Product Features

- HNY7226WT162 Fixed Desk Height worksurfaces, 29" worksurface height
- 5" Solid wood feet - oval shape
- 4 Power outlets with 1 telecom plate, see options below for telecom plate
- Ships KD
- Wire management tray attaches to worksurface top, standard in MFW White, see premium Metal Finish for options
- Hardwire infeed and jumpers are included in workstations
- T75 worksurface wire cutout is standard on all worksurfaces.(T75D: Delete cutout is optional)

Options

Accessories

- K28: Articulating Keyboard w/ Mouse - \$390
- K31-SK: Center drawer w/ skirt - \$310
- K31: Center drawer w/o skirt - \$205

Concealed Floor Power Infeed Cover

- PCEB: White Metal Finish concealed floor power infeed cover - \$150

Delete Top and Wire Tray

- DFP: Delete fixed top. Deduct \$1535 Veneer (W), \$1335 High Pressure Laminate (G), \$953 Thermally Fused Laminate (M) per top

Metal Feet

- MTL10: Replace solid wood feet with metal feet, standard MFW White - \$55 ea

Premium Metal Finish

- Specify premium Metal Finish. See front of Price List
- Premium Metal Finish for WMT Wire Management Tray - \$75 ea
- Premium Metal Finish for MTL10 Metal Feet - \$20 ea
- Premium Metal Finish for PCEB Concealed Floor Power Infeed Cover - \$35

Starter Panel

- RSP: Substitute round starter panel in place of flat starter panel. Must substitute all starters, priced per starter panel - \$83 each. See HNY3555SP888

Telecom Plates

- Each power unit has 1 plate. All telecom connectors sold separately.
- RJ45 (1) - \$55, RJ45 (2) - \$110, RJ45 (3) - \$165, USB (1) - \$70, USB (2) - \$140, RJ45/USB - \$125, RJ45/HDMI - \$210, HDMI/USB - \$205

Worksurface Height

- THL-42: Modify worksurface height to bar height - N/C

4
8

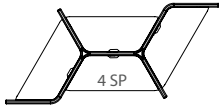

8
14

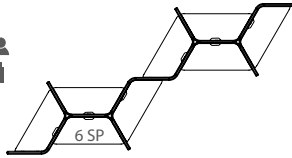

4
8

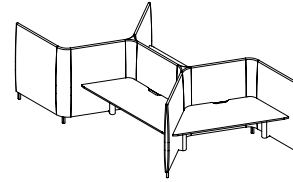

Number of Feet per Typical (MTL10 Option) "SP" Number of Starter Panels per Typical (RSP Option)

1 Select Model

Weight

Standard Veneer Top Upholstered Panels - COM\$

Premium Veneer Top Upholstered Panels - COM\$

High Pressure Laminate Top Upholstered Panels - COM\$

Thermally Fused Laminate Top Upholstered Panels - COM\$

w" x d" x h"	Weight	Model	Price
295 x 153 x 55	49	8 HNY295153HA575W	53736
166 x 78 x 55	26	4 HNY16678HA575W	27381

"P" Option N/A
"P" Option N/A

HNY295153HA575G	52128
HNY16678HA575G	26577

HNY295153HA575M	49072
HNY16678HA575M	25049

[Click here to view statement of line](#)

Product Features

- 5" Solid wood feet - oval shape, ships KD
- 4 Power outlets with 1 telecom plate, see options below for telecom plate
- Adjustable height from 27" to 47.5" with a maximum weight capacity of 275 lbs. Lift standard in MFW White, optional MFB Black
- HNY7125WT163 Height Adjustable worksurfaces are included
- Wire management tray attaches to worksurface top, standard in MFW White, see premium Metal Finish for options
- T75 worksurface wire cutout is standard on all worksurfaces.(T75D: Delete cutout is optional)

Notes

- 1" Gap between worksurface and panels to drop wires below worksurface
- Metal parts include 5 year warranty
- Programmable height adjustable mechanism, motor includes 2 year warranty

Options

Accessories

- K28: Articulating Keyboard w/ Mouse - \$390
- K31-SK: Center drawer w/ skirt - \$310
- K31: Center drawer w/o skirt - \$205

Concealed Floor Power Infeed Cover

- PCEB: White Metal Finish concealed floor power infeed cover - \$150

Delete Top and Wire Tray

- DHAT: Delete height adjustable top. Deduct \$3845 Veneer(W), \$3644 High Pressure Laminate(G), \$3262 Thermally Fused Laminate(M) per top

Metal Feet

- MTL10: Replace solid wood feet with metal feet, standard MFW White - \$55 ea

Premium Metal Finish

- See Front of Price List for Premium Metal Finish Options
- Premium Metal Finish for WMT Wire Management Tray - \$75 ea
- Premium Metal Finish for MTL10 Metal Feet - \$20 ea
- Premium Metal Finish for PCEB Concealed Floor Power Infeed Cover - \$35

Starter Panel

- RSP: Substitute round starter panel in place of flat starter panel. Must substitute all starters, priced per starter panel - \$83 each. See HNY3555SP888

Telecom Plates

- Each power unit has 1 plate. All telecom connectors sold separately.
- RJ45 (1) - \$55, RJ45 (2) - \$110, RJ45 (3) - \$165, USB (1) - \$70, USB (2) - \$140, RJ45/USB - \$125, RJ45/HDMI - \$210, HDMI/USB - \$205

[Click Here for Graded in Pricing](#)

2 Select Finish

[Click to view finishes](#)

[Click to view finishes](#)

[Click to view finishes](#)

3 Select Feet Finish

4 Select Edge

[Click to view details](#)



4
8



8
14

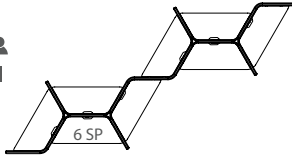

4
8

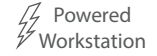
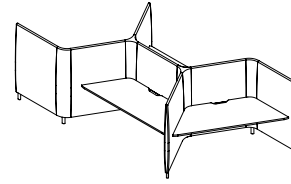

Number of Feet per Typical (MTL10 Option) "SP" Number of Starter Panels per Typical (RSP Option)

1 Select Model

Weight	Standard Veneer Top Upholstered Panels - COM\$	Premium Veneer Top Upholstered Panels - COM\$
295 x 153 x 55	49	8 HNY295153FP575W 34000
166 x 78 x 55	26	4 HNY16678FP575W 17513

High Pressure Laminate Top Upholstered Panels - COM\$	Thermally Fused Laminate Top Upholstered Panels - COM\$
HNY295153FP575G 32336	HNY295153FP575M 29160
HNY16678FP575G 16681	HNY16678FP575M 15093

Product Features

- HNY7226WT162 Fixed Desk Height worksurfaces, 29" worksurface height
- 5" Solid wood feet - oval shape
- 4 Power outlets with 1 telecom plate, see options below for telecom plate
- Ships KD
- Wire management tray attaches to worksurface top, standard in MFW White, see premium Metal Finish for options
- Hardwire infeed and jumpers are included in workstations
- T75 worksurface wire cutout is standard on all worksurfaces.(T75D: Delete cutout is optional)

Options

Accessories

- K28: Articulating Keyboard w/ Mouse - \$390
- K31-SK: Center drawer w/ skirt - \$310
- K31: Center drawer w/o skirt - \$205

Concealed Floor Power Infeed Cover

- PCEB: White Metal Finish concealed floor power infeed cover - \$150

Delete Top and Wire Tray

- DFP: Delete fixed top. Deduct \$1535 Veneer (W), \$1335 High Pressure Laminate (G), \$953 Thermally Fused Laminate (M) per top

Metal Feet

- MTL10: Replace solid wood feet with metal feet, standard MFW White - \$55 ea

Premium Metal Finish

- See Front of Price List for Premium Metal Finish Options
- Premium Metal Finish for WMT Wire Management Tray - \$75 ea
- Premium Metal Finish for MTL10 Metal Feet - \$20 ea
- Premium Metal Finish for PCEB Concealed Floor Power Infeed Cover - \$35

Starter Panel

- RSP: Substitute round starter panel in place of flat starter panel. Must substitute all starters, priced per starter panel - \$83 each. See HNY3555SP888

Telecom Plates

- Each power unit has 1 plate. All telecom connectors sold separately.
- RJ45 (1) - \$55, RJ45 (2) - \$110, RJ45 (3) - \$165, USB (1) - \$70, USB (2) - \$140, RJ45/USB - \$125, RJ45/HDMI - \$210, HDMI/USB - \$205

Worksurface Height

- THL-42: Modify worksurface height to bar height - N/C

[Click Here for Graded in Pricing](#)

2 Select Finish

Click to view finishes

3 Select Feet Finish

4 Select Edge

Click to view details



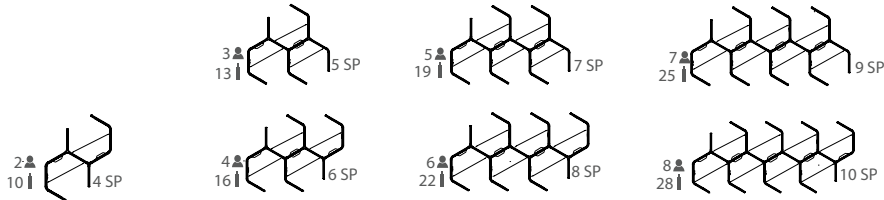

Number of Feet per Typical (MTL10 Option) "SP" Number of Starter Panels per Typical (RSP Option)

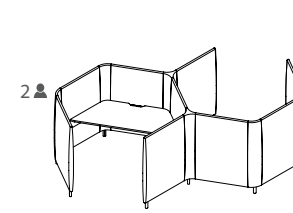

Height Adjustable Workstation

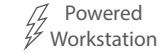

1 Select Model

w" x d" x h"	Weight	Standard Veneer Top Upholstered Panels - COM\$	Premium Veneer Top Upholstered Panels - COM\$	High Pressure Laminate Top Upholstered Panels - COM\$	Thermally Fused Laminate Top Upholstered Panels - COM\$
340 x 150 x 55	103	8 HNY340150HA580W 75401	"P" Option N/A	HNY340150HA580G 73793	HNY340150HA580M 70737
303 x 150 x 55	92	7 HNY303150HA580W 66430	"P" Option N/A	HNY303150HA580G 65023	HNY303150HA580M 62349
265 x 150 x 55	80	6 HNY265150HA580W 57732	"P" Option N/A	HNY265150HA580G 56526	HNY265150HA580M 54234
228 x 150 x 55	69	5 HNY228150HA580W 48761	"P" Option N/A	HNY228150HA580G 47756	HNY228150HA580M 45846
191 x 150 x 55	57	4 HNY191150HA580W 40063	"P" Option N/A	HNY191150HA580G 39259	HNY191150HA580M 37731
153 x 150 x 55	46	3 HNY153150HA580W 31092	"P" Option N/A	HNY153150HA580G 30489	HNY153150HA580M 29343
116 x 150 x 55	34	2 HNY116150HA580W 22394	"P" Option N/A	HNY116150HA580G 21992	HNY116150HA580M 21228

[Click Here for Graded in Pricing](#)

2 Select Finish

[Click to view finishes](#)

[Click to view finishes](#)

[Click to view finishes](#)

3 Select Feet Finish

4 Select Edge

[Click to view details](#)



[Click here to view statement of line](#)

Product Features

- 5" Solid wood feet - oval shape, ships KD
- 4 Power outlets with 1 telecom plate, see options below for telecom plate
- Adjustable height from 27" to 47.5" with a maximum weight capacity of 275 lbs. Lift standard in MFW White, optional MFB Black
- HNY7125WT163 Height Adjustable worksurfaces are included
- Wire management tray attaches to worksurface top, standard in MFW White, see premium Metal Finish for options
- T75 worksurface wire cutout is standard on all worksurfaces.(T75D: Delete cutout is optional)

Notes

- 1" Gap between worksurface and panels to drop wires below worksurface
- Metal parts include 5 year warranty
- Programmable height adjustable mechanism, motor includes 2 year warranty

Options

Accessories

- K28: Articulating Keyboard w/ Mouse - \$390
- K31-SK: Center drawer w/ skirt - \$310
- K31: Center drawer w/o skirt - \$205

Concealed Floor Power Infeed Cover

- PCEB: White Metal Finish concealed floor power infeed cover - \$150

Delete Top and Wire Tray

- DHAT: Delete height adjustable top. Deduct \$3845 Veneer(W), \$3644 High Pressure Laminate(G), \$3262 Thermally Fused Laminate(M) per top

Metal Feet

- MTL10: Replace solid wood feet with metal feet, standard MFW White - \$55 ea

Premium Metal Finish

- See Front of Price List for Premium Metal Finish Options
- Premium Metal Finish for WMT Wire Management Tray - \$75 ea
- Premium Metal Finish for MTL10 Metal Feet - \$20 ea
- Premium Metal Finish for PCEB Concealed Floor Power Infeed Cover - \$35

Starter Panel

- RSP: Substitute round starter panel in place of flat starter panel. Must substitute all starters, priced per starter panel - \$83 each. See HNY3555SP888

Telecom Plates

- Each power unit has 1 plate. All telecom connectors sold separately.
- RJ45 (1) - \$55, RJ45 (2) - \$110, RJ45 (3) - \$165, USB (1) - \$70, USB (2) - \$140, RJ45/USB - \$125, RJ45/HDMI - \$210, HDMI/USB - \$205

DARRAN

Honey

Double Hexagon Workstation Typical
Position 2 Desk with Power Fixed Worksurface

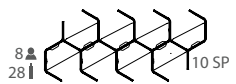
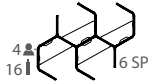
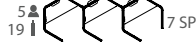
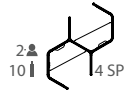

Number of Feet per Typical (MTL10 Option) "SP" Number of Starter Panels per Typical (RSP Option)

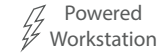
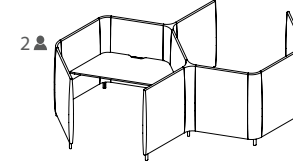

1 Select Model

w" x d" x h"	Weight	Standard Veneer Top Upholstered Panels - COM\$	Premium Veneer Top Upholstered Panels - COM\$
340 x 150 x 55	103	8 HNY340150FP580W 55665	"P" Option N/A
303 x 150 x 55	92	7 HNY303150FP580W 49161	"P" Option N/A
265 x 150 x 55	80	6 HNY265150FP580W 42930	"P" Option N/A
228 x 150 x 55	69	5 HNY228150FP580W 36426	"P" Option N/A
191 x 150 x 55	57	4 HNY191150FP580W 30195	"P" Option N/A
153 x 150 x 55	46	3 HNY153150FP580W 23691	"P" Option N/A
116 x 150 x 55	34	2 HNY116150FP580W 17460	"P" Option N/A

[Click Here for Graded in Pricing](#)

2 Select Finish

Click to view finishes

3 Select Feet Finish

4 Select Edge

Click to view details

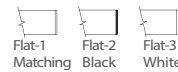
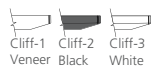

[Click here to view statement of line](#)

Product Features

- HNY7226WT162 Fixed Desk Height worksurfaces, 29" worksurface height
- 5" Solid wood feet - oval shape
- 4 Power outlets with 1 telecom plate, see options below for telecom plate
- Ships KD
- Wire management tray attaches to worksurface top, standard in MFW White, see premium Metal Finish for options
- Hardwire infeed and jumpers are included in workstations
- T75 worksurface wire cutout is standard on all worksurfaces.(T75D: Delete cutout is optional)

Options

Accessories

- K28: Articulating Keyboard w/ Mouse - \$390
- K31-SK: Center drawer w/ skirt - \$310
- K31: Center drawer w/o skirt - \$205

Concealed Floor Power Infeed Cover

- PCEB: White Metal Finish concealed floor power infeed cover - \$150

Delete Top and Wire Tray

- DFP: Delete fixed top. Deduct \$1535 Veneer (W), \$1335 High Pressure Laminate (G), \$953 Thermally Fused Laminate (M) per top

Metal Feet

- MTL10: Replace solid wood feet with metal feet, standard MFW White - \$55 ea

Premium Metal Finish

- See Front of Price List for Premium Metal Finish Options
- Premium Metal Finish for WMT Wire Management Tray - \$75 ea
- Premium Metal Finish for MTL10 Metal Feet - \$20 ea
- Premium Metal Finish for PCEB Concealed Floor Power Infeed Cover - \$35

Starter Panel

- RSP: Substitute round starter panel in place of flat starter panel. Must substitute all starters, priced per starter panel - \$83 each. See HNY3555SP888

Telecom Plates

- Each power unit has 1 plate. All telecom connectors sold separately.
- RJ45 (1) - \$55, RJ45 (2) - \$110, RJ45 (3) - \$165, USB (1) - \$70, USB (2) - \$140, RJ45/USB - \$125, RJ45/HDMI - \$210, HDMI/USB - \$205

Worksurface Height

- THL-42: Modify worksurface height to bar height - N/C

Honey Hexagon Workstation Typical Desk with Height Adjustable Worksurface

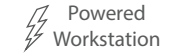
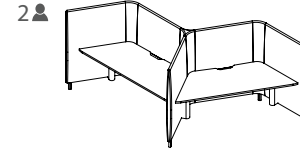
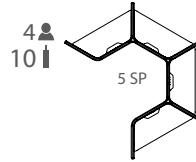
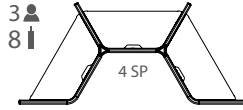
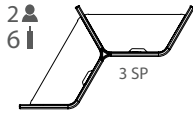
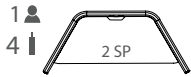

Number of Feet per Typical (MTL10 Option) "SP" Number of Starter Panels per Typical (RSP Option)

1 Select Model

w" x d" x h"	Weight	Standard Veneer Top Upholstered Panels - COM\$	Premium Veneer Top Upholstered Panels - COM\$
166 x 145 x 55	34	4 HNY166145HA582W 30429	"P" Option N/A
166 x 74 x 55	26	3 HNY16674HA582W 23241	"P" Option N/A
125 x 74 x 55	19	2 HNY12574HA582W 16053	"P" Option N/A
85 x 37 x 55	11	1 HNY8537HA582W 8865	"P" Option N/A

[Click Here for Graded in Pricing](#)

2 Select Finish

Click to view finishes

3 Select Feet Finish

4 Select Edge

Click to view details



[Click here to view statement of line](#)

Product Features

- 5" Solid wood feet - oval shape, ships KD
- 4 Power outlets with 1 telecom plate, see options below for telecom plate
- Adjustable height from 27" to 47.5" with a maximum weight capacity of 275 lbs.
- Lift standard in MFW White, optional MFB Black
- HNY7125WT163 Height Adjustable worksurfaces are included
- Wire management tray attaches to worksurface top, standard in MFW White, see premium Metal Finish for options
- T75 worksurface wire cutout is standard on all worksurfaces.(T75D: Delete cutout is optional)

Notes

- 1" Gap between worksurface and panels to drop wires below worksurface
- Metal parts include 5 year warranty
- Programmable height adjustable mechanism, motor includes 2 year warranty

Options

Accessories

- K28: Articulating Keyboard w/ Mouse - \$390
- K31-SK: Center drawer w/ skirt - \$310
- K31: Center drawer w/o skirt - \$205

Concealed Floor Power Infeed Cover

- PCEB: White Metal Finish concealed floor power infeed cover - \$150

Delete Top and Wire Tray

- DHAT: Delete height adjustable top. Deduct \$3845 Veneer(W), \$3644 High Pressure Laminate(G), \$3262 Thermally Fused Laminate(M) per top

Metal Feet

- MTL10: Replace solid wood feet with metal feet, standard MFW White - \$55 ea

Premium Metal Finish

- See Front of Price List for Premium Metal Finish Options
- Premium Metal Finish for WMT Wire Management Tray - \$75 ea
- Premium Metal Finish for MTL10 Metal Feet - \$20 ea
- Premium Metal Finish for PCEB Concealed Floor Power Infeed Cover - \$35

Starter Panel

- RSP: Substitute round starter panel in place of flat starter panel. Must substitute all starters, priced per starter panel - \$83 each. See HNY3555SP888

Telecom Plates

- Each power unit has 1 plate. All telecom connectors sold separately.
- RJ45 (1) - \$55, RJ45 (2) - \$110, RJ45 (3) - \$165, USB (1) - \$70, USB (2) - \$140, RJ45/USB - \$125, RJ45/HDMI - \$210, HDMI/USB - \$205

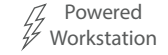
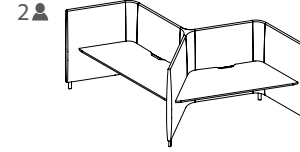
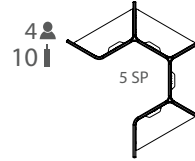
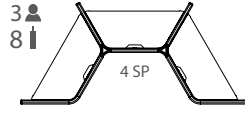
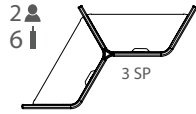

Number of Feet per Typical (MTL10 Option) "SP" Number of Starter Panels per Typical (RSP Option)

1 Select Model

Weight

Standard Veneer Top
Upholstered Panels - COM\$

Premium Veneer Top
Upholstered Panels - COM\$

High Pressure Laminate Top
Upholstered Panels - COM\$

Thermally Fused Laminate Top
Upholstered Panels - COM\$

w" x d" x h"	Weight	Standard Veneer Top Upholstered Panels - COM\$	Premium Veneer Top Upholstered Panels - COM\$
166 x 145 x 55	34	4 HNY166145FP582W 20561	"P" Option N/A
166 x 74 x 55	26	3 HNY16674FP582W 15840	"P" Option N/A
125 x 74 x 55	19	2 HNY12574FP582W 11119	"P" Option N/A
85 x 37 x 55	11	1 HNY8537FP582W 6398	"P" Option N/A

HNY166145FP582G	19729
HNY16674FP582G	15216
HNY12574FP582G	10703
HNY8537FP582G	6190

HNY166145FP582M	18141
HNY16674FP582M	14025
HNY12574FP582M	9909
HNY8537FP582M	5793

[Click here to view statement of line](#)

Product Features

- HNY7226WT162 Fixed Desk Height worksurfaces, 29" worksurface height
- 5" Solid wood feet - oval shape
- 4 Power outlets with 1 telecom plate, see options below for telecom plate
- Ships KD
- Wire management tray attaches to worksurface top, standard in MFW White, see premium Metal Finish for options
- Hardwire infeed and jumpers are included in workstations
- T75 worksurface wire cutout is standard on all worksurfaces.(T75D: Delete cutout is optional)

Options

Accessories

- K28: Articulating Keyboard w/ Mouse - \$390
- K31-SK: Center drawer w/ skirt - \$310
- K31: Center drawer w/o skirt - \$205

Concealed Floor Power Infeed Cover

- PCEB: White Metal Finish concealed floor power infeed cover - \$150

Delete Top and Wire Tray

- DFP: Delete fixed top. Deduct \$1535 Veneer (W), \$1335 High Pressure Laminate (G), \$953 Thermally Fused Laminate (M) per top

Metal Feet

- MTL10: Replace solid wood feet with metal feet, standard MFW White - \$55 ea

Premium Metal Finish

- See Front of Price List for Premium Metal Finish Options
- Premium Metal Finish for WMT Wire Management Tray - \$75 ea
- Premium Metal Finish for MTL10 Metal Feet - \$20 ea
- Premium Metal Finish for PCEB Concealed Floor Power Infeed Cover - \$35

Starter Panel

- RSP: Substitute round starter panel in place of flat starter panel. Must substitute all starters, priced per starter panel - \$83 each. See HNY3555SP888

Telecom Plates

- Each power unit has 1 plate. All telecom connectors sold separately.
- RJ45 (1) - \$55, RJ45 (2) - \$110, RJ45 (3) - \$165, USB (1) - \$70, USB (2) - \$140, RJ45/USB - \$125, RJ45/HDMI - \$210, HDMI/USB - \$205

Worksurface Height

- THL-42: Modify worksurface height to bar height - N/C

[Click Here for Graded in Pricing](#)

2 Select Finish

[Click to view finishes](#)

[Click to view finishes](#)

[Click to view finishes](#)

3 Select Feet Finish

4 Select Edge

[Click to view details](#)



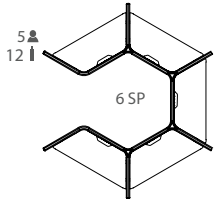

Number of Feet per Typical (MTL10 Option) "SP" Number of Starter Panels per Typical (RSP Option)

1 Select Model

Weight	Standard Veneer Top Upholstered Panels - COM\$	Premium Veneer Top Upholstered Panels - COM\$
w" x d" x h" 166 x 145 x 55	41	5 HNY166145HA583W 37617

[Click Here for Graded in Pricing](#)

2 Select Finish

Click to view finishes

3 Select Feet Finish

4 Select Edge

Click to view details

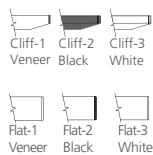

Premium Veneer Top Upholstered Panels - COM\$
"P" Option N/A

High Pressure Laminate Top Upholstered Panels - COM\$
HNY166145HA583G 36612

Click to view finishes

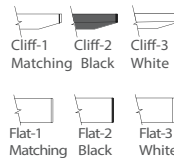

Thermally Fused Laminate Top Upholstered Panels - COM\$
HNY166145HA583M 34702

Click to view finishes

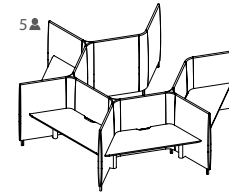

[Click here to view statement of line](#)

Product Features

- 5" Solid wood feet - oval shape, ships KD
- 4 Power outlets with 1 telecom plate, see options below for telecom plate
- Adjustable height from 27" to 47.5" with a maximum weight capacity of 275 lbs.
- Lift standard in MFW White, optional MFB Black
- HNY7125WT163 Height Adjustable worksurfaces are included
- Wire management tray attaches to worksurface top, standard in MFW White, see premium Metal Finish for options
- T75 worksurface wire cutout is standard on all worksurfaces.(T75D: Delete cutout is optional)

Notes

- 1" Gap between worksurface and panels to drop wires below worksurface
- Metal parts include 5 year warranty
- Programmable height adjustable mechanism, motor includes 2 year warranty

Options

Accessories

- K28: Articulating Keyboard w/ Mouse - \$390
- K31-SK: Center drawer w/ skirt - \$310
- K31: Center drawer w/o skirt - \$205

Concealed Floor Power Infeed Cover

- PCEB: White Metal Finish concealed floor power infeed cover - \$150

Delete Top and Wire Tray

- DHAT: Delete height adjustable top. Deduct \$3845 Veneer(W), \$3644 High Pressure Laminate(G), \$3262 Thermally Fused Laminate(M) per top

Metal Feet

- MTL10: Replace solid wood feet with metal feet, standard MFW White - \$55 ea

Premium Metal Finish

- See Front of Price List for Premium Metal Finish Options
- Premium Metal Finish for WMT Wire Management Tray - \$75 ea
- Premium Metal Finish for MTL10 Metal Feet - \$20 ea
- Premium Metal Finish for PCEB Concealed Floor Power Infeed Cover - \$35

Starter Panel

- RSP: Substitute round starter panel in place of flat starter panel. Must substitute all starters, priced per starter panel - \$83 each. See HNY3555SP888

Telecom Plates

- Each power unit has 1 plate. All telecom connectors sold separately.
- RJ45 (1) - \$55, RJ45 (2) - \$110, RJ45 (3) - \$165, USB (1) - \$70, USB (2) - \$140, RJ45/USB - \$125, RJ45/HDMI - \$210, HDMI/USB - \$205

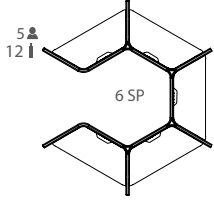

Number of Feet per Typical (MTL10 Option) "SP" Number of Starter Panels per Typical (RSP Option)

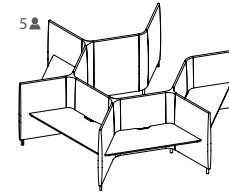

Fixed Top Workstation

Powered Workstation

1 Select Model

w" x d" x h"
166 x 145 x 55

Weight
41

Standard Veneer Top Upholstered Panels - COM\$
5 HNY166145FP583W 25282

Premium Veneer Top Upholstered Panels - COM\$
"P" Option N/A

High Pressure Laminate Top Upholstered Panels - COM\$
HNY166145FP583G 24242

Thermally Fused Laminate Top Upholstered Panels - COM\$
HNY166145FP583M 22257

[Click here to view statement of line](#)

Product Features

- HNY7226WT162 Fixed Desk Height worksurfaces, 29" worksurface height
- 5" Solid wood feet - oval shape
- 4 Power outlets with 1 telecom plate, see options below for telecom plate
- Ships KD
- Wire management tray attaches to worksurface top, standard in MFW White, see premium Metal Finish for options
- Hardwire infeed and jumpers are included in workstations
- T75 worksurface wire cutout is standard on all worksurfaces.(T75D: Delete cutout is optional)

Options

Accessories

- K28: Articulating Keyboard w/ Mouse - \$390
- K31-SK: Center drawer w/ skirt - \$310
- K31: Center drawer w/o skirt - \$205

Concealed Floor Power Infeed Cover

- PCEB: White Metal Finish concealed floor power infeed cover - \$150

Delete Top and Wire Tray

- DFP: Delete fixed top. Deduct \$1535 Veneer (W), \$1335 High Pressure Laminate (G), \$953 Thermally Fused Laminate (M) per top

Metal Feet

- MTL10: Replace solid wood feet with metal feet, standard MFW White - \$55 ea

Premium Metal Finish

- See Front of Price List for Premium Metal Finish Options
- Premium Metal Finish for WMT Wire Management Tray - \$75 ea
- Premium Metal Finish for MTL10 Metal Feet - \$20 ea
- Premium Metal Finish for PCEB Concealed Floor Power Infeed Cover - \$35

Starter Panel

- RSP: Substitute round starter panel in place of flat starter panel. Must substitute all starters, priced per starter panel - \$83 each. See HNY3555SP888

Telecom Plates

- Each power unit has 1 plate. All telecom connectors sold separately.
- RJ45 (1) - \$55, RJ45 (2) - \$110, RJ45 (3) - \$165, USB (1) - \$70, USB (2) - \$140, RJ45/USB - \$125, RJ45/HDMI - \$210, HDMI/USB - \$205

Worksurface Height

- THL-42: Modify worksurface height to bar height - N/C

[Click Here for Graded in Pricing](#)

2 Select Finish

[Click to view finishes](#)

[Click to view finishes](#)

[Click to view finishes](#)

3 Select Feet Finish

4 Select Edge

[Click to view details](#)



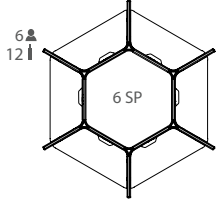

Number of Feet per Typical (MTL10 Option) "SP" Number of Starter Panels per Typical (RSP Option)

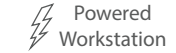
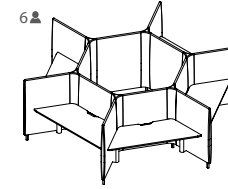

1 Select Model

w" x d" x h"	Weight	Standard Veneer Top Upholstered Panels - COM\$	Premium Veneer Top Upholstered Panels - COM\$
166 x 145 x 55	45	6 HNY166145HA584W 43333	"P" Option N/A

[Click Here for Graded in Pricing](#)

2 Select Finish

Click to view finishes

3 Select Feet Finish

4 Select Edge

Click to view details

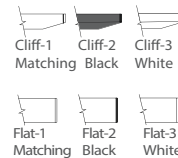
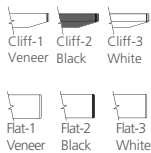

[Click here to view statement of line](#)

Product Features

- 5" Solid wood feet - oval shape, ships KD
- 4 Power outlets with 1 telecom plate, see options below for telecom plate
- Adjustable height from 27" to 47.5" with a maximum weight capacity of 275 lbs.
- Lift standard in MFW White, optional MFB Black
- HNY7125WT163 Height Adjustable worksurfaces are included
- Wire management tray attaches to worksurface top, standard in MFW White, see premium Metal Finish for options
- T75 worksurface wire cutout is standard on all worksurfaces.(T75D: Delete cutout is optional)

Notes

- 1" Gap between worksurface and panels to drop wires below worksurface
- Metal parts include 5 year warranty
- Programmable height adjustable mechanism, motor includes 2 year warranty

Options

Accessories

- K28: Articulating Keyboard w/ Mouse - \$390
- K31-SK: Center drawer w/ skirt - \$310
- K31: Center drawer w/o skirt - \$205

Concealed Floor Power Infeed Cover

- PCEB: White Metal Finish concealed floor power infeed cover - \$150

Delete Top and Wire Tray

- DHAT: Delete height adjustable top. Deduct \$3845 Veneer(W), \$3644 High Pressure Laminate(G), \$3262 Thermally Fused Laminate(M) per top

Metal Feet

- MTL10: Replace solid wood feet with metal feet, standard MFW White - \$55 ea

Premium Metal Finish

- See Front of Price List for Premium Metal Finish Options
- Premium Metal Finish for WMT Wire Management Tray - \$75 ea
- Premium Metal Finish for MTL10 Metal Feet - \$20 ea
- Premium Metal Finish for PCEB Concealed Floor Power Infeed Cover - \$35

Starter Panel

- RSP: Substitute round starter panel in place of flat starter panel. Must substitute all starters, priced per starter panel - \$83 each. See HNY3555SP888

Telecom Plates

- Each power unit has 1 plate. All telecom connectors sold separately.
- RJ45 (1) - \$55, RJ45 (2) - \$110, RJ45 (3) - \$165, USB (1) - \$70, USB (2) - \$140, RJ45/USB - \$125, RJ45/HDMI - \$210, HDMI/USB - \$205

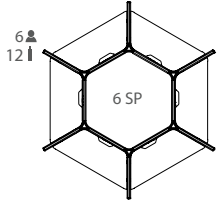

Number of Feet per Typical (MTL10 Option) "SP" Number of Starter Panels per Typical (RSP Option)

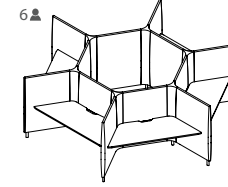

Fixed Top Workstation

Powered Workstation

1 Select Model

Weight

Standard Veneer Top Upholstered Panels - COM\$

Premium Veneer Top Upholstered Panels - COM\$

High Pressure Laminate Top Upholstered Panels - COM\$

Thermally Fused Laminate Top Upholstered Panels - COM\$

Product Features

- HNY7226WT162 Fixed Desk Height worksurfaces, 29" worksurface height
- 5" Solid wood feet - oval shape
- 4 Power outlets with 1 telecom plate, see options below for telecom plate
- Ships KD
- Wire management tray attaches to worksurface top, standard in MFW White, see premium Metal Finish for options
- Hardwire infeed and jumpers are included in workstations
- T75 worksurface wire cutout is standard on all worksurfaces.(T75D: Delete cutout is optional)

w" x d" x h"
166 x 145 x 55 45 6 HNY166145FP584W 28531

"P" Option N/A

HNY166145FP584G 27283

HNY166145FP584M 24901

[Click Here for Graded in Pricing](#)

2 Select Finish

[Click to view finishes](#)

[Click to view finishes](#)

[Click to view finishes](#)

3 Select Feet Finish

4 Select Edge

[Click to view details](#)



[Click here to view statement of line](#)

Options

Accessories

- K28: Articulating Keyboard w/ Mouse - \$390
- K31-SK: Center drawer w/ skirt - \$310
- K31: Center drawer w/o skirt - \$205

Concealed Floor Power Infeed Cover

- PCEB: White Metal Finish concealed floor power infeed cover - \$150

Delete Top and Wire Tray

- DFP: Delete fixed top. Deduct \$1535 Veneer (W), \$1335 High Pressure Laminate (G), \$953 Thermally Fused Laminate (M) per top

Metal Feet

- MTL10: Replace solid wood feet with metal feet, standard MFW White - \$55 ea

Premium Metal Finish

- See Front of Price List for Premium Metal Finish Options
- Premium Metal Finish for WMT Wire Management Tray - \$75 ea
- Premium Metal Finish for MTL10 Metal Feet - \$20 ea
- Premium Metal Finish for PCEB Concealed Floor Power Infeed Cover - \$35

Starter Panel

- RSP: Substitute round starter panel in place of flat starter panel. Must substitute all starters, priced per starter panel - \$83 each. See HNY3555SP888

Telecom Plates

- Each power unit has 1 plate. All telecom connectors sold separately.
- RJ45 (1) - \$55, RJ45 (2) - \$110, RJ45 (3) - \$165, USB (1) - \$70, USB (2) - \$140, RJ45/USB - \$125, RJ45/HDMI - \$210, HDMI/USB - \$205

Worksurface Height

- THL-42: Modify worksurface height to bar height - N/C

DARRAN

Honey

S-Shaped Workstation Typical
Desk with Height Adjustable Worksurface

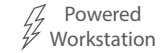
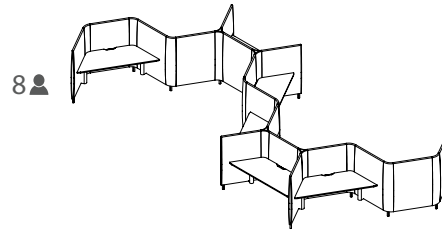
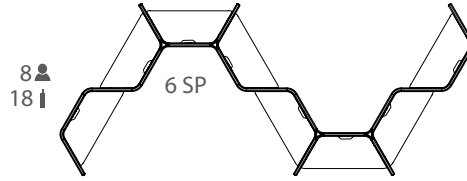
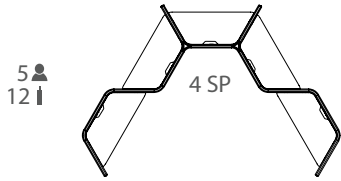

Number of Feet per Typical (MTL10 Option) "SP" Number of Starter Panels per Typical (RSP Option)

1 Select Model

Weight	Standard Veneer Top Upholstered Panels - COM\$
w" x d" x h"	
347 x 145 x 55	65 8 HNY347145HA586W 61134
217 x 145 x 55	42 5 HNY217145HA586W 38919

Weight	Premium Veneer Top Upholstered Panels - COM\$
	"P" Option N/A
	"P" Option N/A

Weight	High Pressure Laminate Top Upholstered Panels - COM\$
	HNY347145HA586G 59526
	HNY217145HA586G 37914

Weight	Thermally Fused Laminate Top Upholstered Panels - COM\$
	HNY347145HA586M 56470
	HNY217145HA586M 36004

Product Features

- 5" Solid wood feet - oval shape, ships KD
- 4 Power outlets with 1 telecom plate, see options below for telecom plate
- Adjustable height from 27" to 47.5" with a maximum weight capacity of 275 lbs.
- Lift standard in MFW White, optional MFB Black
- HNY7125WT163 Height Adjustable worksurfaces are included
- Wire management tray attaches to worksurface top, standard in MFW White, see premium Metal Finish for options
- T75 worksurface wire cutout is standard on all worksurfaces.(T75D: Delete cutout is optional)

Notes

- 1" Gap between worksurface and panels to drop wires below worksurface
- Metal parts include 5 year warranty
- Programmable height adjustable mechanism, motor includes 2 year warranty

Options

Accessories

- K28: Articulating Keyboard w/ Mouse - \$390
- K31-SK: Center drawer w/ skirt - \$310
- K31: Center drawer w/o skirt - \$205

Concealed Floor Power Infeed Cover

- PCEB: White Metal Finish concealed floor power infeed cover - \$150

Delete Top and Wire Tray

- DHAT: Delete height adjustable top. Deduct \$3845 Veneer(W), \$3644 High Pressure Laminate(G), \$3262 Thermally Fused Laminate(M) per top

Metal Feet

- MTL10: Replace solid wood feet with metal feet, standard MFW White - \$55 ea

Premium Metal Finish

- See Front of Price List for Premium Metal Finish Options
- Premium Metal Finish for WMT Wire Management Tray - \$75 ea
- Premium Metal Finish for MTL10 Metal Feet - \$20 ea
- Premium Metal Finish for PCEB Concealed Floor Power Infeed Cover - \$35

Starter Panel

- RSP: Substitute round starter panel in place of flat starter panel. Must substitute all starters, priced per starter panel - \$83 each. See HNY3555SP888

Telecom Plates

- Each power unit has 1 plate. All telecom connectors sold separately.
- RJ45 (1) - \$55, RJ45 (2) - \$110, RJ45 (3) - \$165, USB (1) - \$70, USB (2) - \$140, RJ45/USB - \$125, RJ45/HDMI - \$210, HDMI/USB - \$205

[Click Here for Graded in Pricing](#)

2 Select Finish

[Click to view finishes](#)

[Click to view finishes](#)

[Click to view finishes](#)

3 Select Feet Finish

4 Select Edge

[Click to view details](#)



DARRAN

Honey

S-Shaped Workstation Typical
Desk with Power Fixed Worksurface

5
12

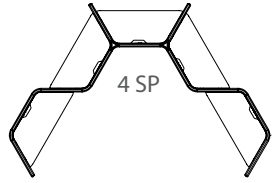

4 SP

8
18



6 SP

8

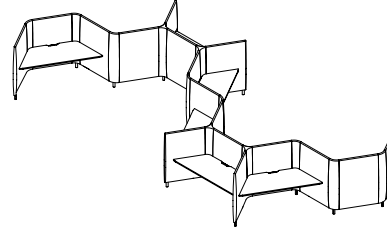

Number of Feet per Typical (MTL10 Option) "SP" Number of Starter Panels per Typical (RSP Option)

1 Select Model

Weight

Standard Veneer Top
Upholstered Panels - COM\$

Premium Veneer Top
Upholstered Panels - COM\$

High Pressure Laminate Top
Upholstered Panels - COM\$

Thermally Fused Laminate Top
Upholstered Panels - COM\$

w" x d" x h"	Weight	8	5
347 x 145 x 55	65	HNY347145FP586W 41398	HNY217145FP586W 26584
217 x 145 x 55	42	HNY347145FP586G 39734	HNY217145FP586G 25544

"P" Option N/A
"P" Option N/A

HNY347145FP586G 39734
HNY217145FP586G 25544

HNY347145FP586M 36558
HNY217145FP586M 23559

[Click here to view statement of line](#)

Product Features

- HNY7226WT162 Fixed Desk Height worksurfaces, 29" worksurface height
- 5" Solid wood feet - oval shape
- 4 Power outlets with 1 telecom plate, see options below for telecom plate
- Ships KD
- Wire management tray attaches to worksurface top, standard in MFW White, see premium Metal Finish for options
- Hardwire infeed and jumpers are included in workstations
- T75 worksurface wire cutout is standard on all worksurfaces.(T75D: Delete cutout is optional)

Options

Accessories

- K28: Articulating Keyboard w/ Mouse - \$390
- K31-SK: Center drawer w/ skirt - \$310
- K31: Center drawer w/o skirt - \$205

Concealed Floor Power Infeed Cover

- PCEB: White Metal Finish concealed floor power infeed cover - \$150

Delete Top and Wire Tray

- DFP: Delete fixed top. Deduct \$1535 Veneer (W), \$1335 High Pressure Laminate (G), \$953 Thermally Fused Laminate (M) per top

Metal Feet

- MTL10: Replace solid wood feet with metal feet, standard MFW White - \$55 ea

Premium Metal Finish

- See Front of Price List for Premium Metal Finish Options
- Premium Metal Finish for WMT Wire Management Tray - \$75 ea
- Premium Metal Finish for MTL10 Metal Feet - \$20 ea
- Premium Metal Finish for PCEB Concealed Floor Power Infeed Cover - \$35

Starter Panel

- RSP: Substitute round starter panel in place of flat starter panel. Must substitute all starters, priced per starter panel - \$83 each. See HNY3555SP888

Telecom Plates

- Each power unit has 1 plate. All telecom connectors sold separately.
- RJ45 (1) - \$55, RJ45 (2) - \$110, RJ45 (3) - \$165, USB (1) - \$70, USB (2) - \$140, RJ45/USB - \$125, RJ45/HDMI - \$210, HDMI/USB - \$205

Worksurface Height

- THL-42: Modify worksurface height to bar height - N/C

[Click Here for Graded in Pricing](#)

2 Select Finish

[Click to view finishes](#)

[Click to view finishes](#)

[Click to view finishes](#)

3 Select Feet Finish

4 Select Edge

[Click to view details](#)



Honey

120° Lounge
Lounge with Seat and Back Cushions

[Click here to view statement of line](#)

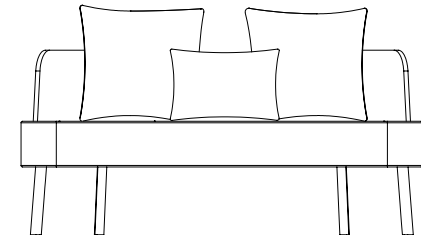

1 Model HNY0170HPB48

w" x d" x h"
60 x 26.5 x 27

COM	COL	1	2	3	4	5	6	7	8	9	10	11/L1	12	13/L2
3716	N/A	3898	3989	4080	4171	4262	4353	4444	4535	4626	4717	4808	4899	5081

Upholstery Requirements
Fabric yds: 5 Leather Sq. Ft.:90
Carton Weight:100

2 Select Finish

[Click to view finishes](#)

3 Combination Fabrics

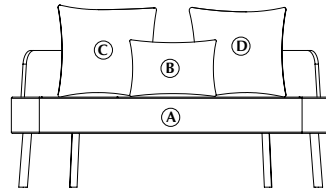

DARRAN is pleased to offer customers the design freedom of combination fabrics. When using fabric, vinyl or leather combinations, pricing/yardage requirements will be as follows:

- A Lounge Seat 2.5 yd. (s)
- B Lounge Pillow 1 yd.
- C Lounge Pillow 1 yd.
- D Lounge Pillow 1 yd.

- When combining two materials of the same grade, pricing will be specified grade + 5%
- If combining two materials of different grades or leather/fabric combination, use the highest grade/price + 5%
- If using COM or COL, pricing will be COM or COL + 5%.
- If both COM + COL are used in combination, use COL + 5%.

Product Features

- 10.5" Solid wood feet - oval shape
- 4" high resiliency foam seat
- 3/4" Bent plywood back with rift cut oak or walnut veneer
- (2) 20" pillows, (1) 16" pillow
- Solid wood base to maximize strength and longevity

Options

Premium Metal Finish

- See Front of Price List for Premium Metal Finish Options
- Premium Metal Finish for MTL12 metal legs: \$20 ea

Metal Feet

- MTL12: Replace solid wood legs with metal legs, standard in MFW White - \$75 ea

Honey

120° Starter Panel
Round End

[Click here to view statement of line](#)

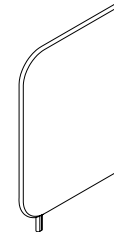

1 Model HNY3555SP888

w" x d" x h"
35 x 3 x 55

COM	COL	1	2	3	4	5	6	7	8	9	10	11/L1	12	13/L2
1087	N/A	1198	1253	1308	1363	1418	1473	1528	1583	1638	1693	1748	1803	1913

Upholstery Requirements
Fabric yds: 3 Leather Sq. Ft.:N/A
Carton Weight:20

Product Features

- 5" Solid wood feet - oval shape

Notes

- To configure workstations, customer is required to send drawing

Options

Metal Feet

- MTL10: Replace solid wood feet with metal feet, standard in MFW White - \$55 ea

Premium Metal Finish

- See Front of Price List for Premium Metal Finish Options
- Premium Metal Finish for MTL10: Metal feet \$20 per foot

2 Select Finish

[Click to view finishes](#)

3 Combination Fabrics

Combination
Fabric Option
Not Available

Honey

120° Starter Panel
Flat End

[Click here to view statement of line](#)



1 Model HNY3555SP889

w" x d" x h"
35 x 3 x 55

COM	COL	1	2	3	4	5	6	7	8	9	10	11/L1	12	13/L2
984	N/A	1095	1150	1205	1260	1315	1370	1425	1480	1535	1590	1645	1700	1810

Upholstery Requirements
Fabric yds: 3 Leather Sq. Ft.:N/A
Carton Weight:20

Product Features

- 5" Solid wood feet - oval shape

Notes

- To configure workstations, customer is required to send drawing

Options

Metal Feet

- MTL10: Replace solid wood feet with metal feet, standard in MFW White - \$55 ea

Premium Metal Finish

- See Front of Price List for Premium Metal Finish Options
- Premium Metal Finish for MTL10: Metal feet \$20 per foot

2 Select Finish

[Click to view finishes](#)

3 Combination Fabrics

Combination
Fabric Option
Not Available

Honey

120° Corner Panel Connector
Two Corner Panel

[Click here to view statement of line](#)



1 Model
HNY0955CP890

w" x d" x h"
9 x 9 x 55

COM	COL	1	2	3	4	5	6	7	8	9	10	11/L1	12	13/L2
636	N/A	673	691	709	727	745	763	781	799	817	835	853	871	907

Upholstery Requirements
Fabric yds: 1 Leather Sq. Ft.:N/A
Carton Weight:10

Product Features

- 5" Solid wood feet - oval shape

Notes

- To configure workstations, customer is required to send drawing

Options

Metal Feet

- MTL10: Replace solid wood feet with metal feet, standard in MFW White - \$55 ea

Premium Metal Finish

- See Front of Price List for Premium Metal Finish Options
- Premium Metal Finish for MTL10: Metal feet \$20 per foot

2 Select Finish

[Click to view finishes](#)

3 Combination Fabrics

Combination
Fabric Option
Not Available

Honey

120° Corner Panel Connector
Three Corner Panel

[Click here to view statement of line](#)

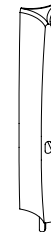

1 Model
HNY0855CP891

w" x d" x h"
8 x 8 x 55

COM	COL	1	2	3	4	5	6	7	8	9	10	11/L1	12	13/L2
784	N/A	840	867	894	921	948	975	1002	1029	1056	1083	1110	1137	1191

Upholstery Requirements
Fabric yds: 1.5 Leather Sq. Ft.:N/A
Carton Weight:10

Product Features

- 5" Solid wood feet - oval shape

Notes

- To configure workstations, customer is required to send drawing

Options

Metal Feet

- MTL10: Replace solid wood feet with metal feet, standard in MFW White - \$55 ea

Premium Metal Finish

- See Front of Price List for Premium Metal Finish Options
- Premium Metal Finish for MTL10: Metal feet \$20 per foot

2 Select Finish

[Click to view finishes](#)

3 Combination Fabrics

Combination
Fabric Option
Not Available

Honey

In-Line Panel Connector
Straight Run Connector

[Click here to view statement of line](#)



1 Model
HNY1655CP886

w" x d" x h"
16 x 3 x 55

COM	COL	1	2	3	4	5	6	7	8	9	10	11/L1	12	13/L2
555	N/A	592	610	628	646	664	682	700	718	736	754	772	790	826

Upholstery Requirements
Fabric yds: 1 Leather Sq. Ft.:N/A
Carton Weight:20

Product Features

- 5" Solid wood feet - oval shape

Notes

- To configure workstations, customer is required to send drawing

Options

Metal Feet

- MTL10: Replace solid wood feet with metal feet, standard in MFW White - \$55 ea

Premium Metal Finish

- See Front of Price List for Premium Metal Finish Options
- Premium Metal Finish for MTL10: Metal feet \$20 per foot

2 Select Finish

[Click to view finishes](#)

3 Combination Fabrics

Combination
Fabric Option
Not Available

Honey

120° Adder Panel
No Power Access

[Click here to view statement of line](#)

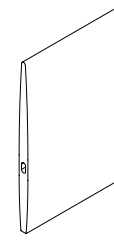

1 Model HNY3450AP894

w" x d" x h"
34 x 3 x 50

COM	COL	1	2	3	4	5	6	7	8	9	10	11/L1	12	13/L2
1015	N/A	1126	1181	1236	1291	1346	1401	1456	1511	1566	1621	1676	1731	1841

Upholstery Requirements
Fabric yds: 3 Leather Sq. Ft.:N/A
Carton Weight:20

Product Features

- Adder panel

Notes

- To configure workstations, customer is required to send drawing
- Panel overall height is 55" with feet. Panel overall height without feet is 50"

2 Select Finish

[Click to view finishes](#)

Finish N/A

3 Combination Fabrics

Combination
Fabric Option
Not Available

Honey

120° Adder Access Panel
Single Sided Access

[Click here to view statement of line](#)

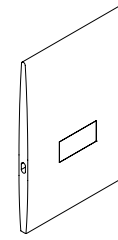

1 Model
HNY3450AP895

w" x d" x h"
34 x 3 x 50

COM	COL	1	2	3	4	5	6	7	8	9	10	11/L1	12	13/L2
1077	N/A	1188	1243	1298	1353	1408	1463	1518	1573	1628	1683	1738	1793	1903

Upholstery Requirements
Fabric yds: 3 Leather Sq. Ft.:N/A
Carton Weight:20

Product Features

- Panel features access panel for wire management

Notes

- To configure workstations, customer is required to send drawing
- Panel overall height is 55" with feet. Panel overall height without feet is 50"
- Removable panel allows wire access for cable management

2 Select Finish

[Click to view finishes](#)

Finish N/A

3 Combination Fabrics

Combination
Fabric Option
Not Available

Honey

120° Single Sided Power Panel
Power Panel

[Click here to view statement of line](#)

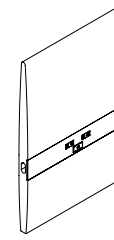

1 Model HNY3450PP892

w" x d" x h"
34 x 3 x 50

COM	COL	1	2	3	4	5	6	7	8	9	10	11/L1	12	13/L2
1220	N/A	1331	1386	1441	1496	1551	1606	1661	1716	1771	1826	1881	1936	2046

Upholstery Requirements
Fabric yds: 3 Leather Sq. Ft.:N/A
Carton Weight:20

2 Select Finish

[Click to view finishes](#)

Finish N/A

3 Combination Fabrics

Combination
Fabric Option
Not Available

Product Features

- 4 power outlets with 1 telecom plate, see options below for telecom plate

Notes

- To configure workstations, customer is required to send drawing
- Panel overall height is 55" with feet. Panel overall height without feet is 50"
- Jumper(s) or hardwired infeed must be selected to power workstations. See options below.

Options

Jumper(s) and Infeed

- Specify Jumper or Infeed to power workstations
- JC42: 42" Length jumper, passes through corner post connecting panel to panel - \$145.
- JC96: 96" Length jumper, passes through 1 adder panel connecting 3 panels - \$215
- JC150: 150" Length jumper passes through 2 adder panels connecting 4 panels - \$290
- JC204: 204" Length jumper passes through corner post connecting 3 panels - \$350
- HPP192: 192" hardwired power feed -\$350
- CPF72: 72" corded power feed -\$275

Telecom Plates

- Each power unit has 1 plate. All telecom connectors sold separately.
- RJ45 (1) - \$55, RJ45 (2) - \$110, RJ45 (3) - \$165, USB (1) - \$70, USB (2) - \$140, RJ45/USB - \$125, RJ45/HDMI - \$210, HDMI/USB - \$205

Honey

120° Double Sided Power Panel
Power Panel

[Click here to view statement of line](#)

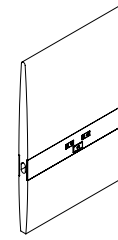

1 Model HNY3450PP893

w" x d" x h"
34 x 3 x 50

COM	COL	1	2	3	4	5	6	7	8	9	10	11/L1	12	13/L2
1305	N/A	1416	1471	1526	1581	1636	1691	1746	1801	1856	1911	1966	2021	2131

Upholstery Requirements
Fabric yds: 3 Leather Sq. Ft.:N/A
Carton Weight:20

2 Select Finish

[Click to view finishes](#)

Finish N/A

3 Combination Fabrics

Combination
Fabric Option
Not Available

Product Features

- Double sided power panel, each panel side features 4 power outlets with 1 telecom plate. See options below for telecom plate

Notes

- To configure workstations, customer is required to send drawing
- Panel overall height is 55" with feet. Panel overall height without feet is 50"
- Jumper(s) or hardwired infeed must be selected to power workstations. See options below.

Options

Jumper(s) and Infeed

- Specify Jumper or Infeed to power workstations
- JC42: 42" Length jumped, passes through corner post connecting panel to panel - \$145.
- JC96: 96" Length jumper, passes through 1 adder panel connecting 3 panels - \$215
- JC150: 150" Length jumper passes through 2 adder panels connecting 4 panels - \$290
- JC204: 204" Length jumper passes through corner post connecting 3 panels - \$350
- HPF192: 192" hardwired power feed -\$350
- CPF72: 72" corded power feed -\$275

Telecom Plates

- Each power unit has 1 plate. All telecom connectors sold separately.
- RJ45 (1) - \$55, RJ45 (2) - \$110, RJ45 (3) - \$165, USB (1) - \$70, USB (2) - \$140, RJ45/USB - \$125, RJ45/HDMI - \$210, HDMI/USB - \$205

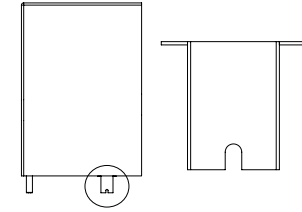

Shown on
HNY3555SP88
Panel not incl

1 Select Model

Weight

Power Infeed Cover

5 x 2 x 6

PCEB

164

2 Select Finish

[Click to view finishes](#)

[Click to view finishes](#)

[Click to view finishes](#)

3 Select Feet Finish

4 Select Edge

[Click to view details](#)

Edge
N/A

[Click here to view statement of line](#)

Product Features

- Conceals wire infeed from the floor and mounts to the bottom of honey panels
- White Metal Finish standard

Notes

- PANEL NOT INCLUDED

Options

Premium Metal Finish - Power Box

- Specify Metal Finish \$35/ea. See Front of PriceList for Premium Options

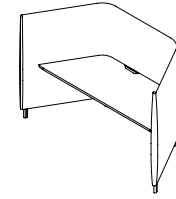

Panels
not included

[Click here to view statement of line](#)

1 Select Model

Weight

Standard Veneer Top

Premium Veneer Top

High Pressure Laminate Top

Thermally Fused Laminate Top

w" x d" x h"	Weight	Standard Veneer Top	Premium Veneer Top
Bar Height 42"			
72 x 26 x 1	60	HNY7226WT160W 1378	"P" Option N/A
63.5 x 19 x 1	50	HNY6319WT160W 1158	"P" Option N/A
Desk Height 29"			
72 x 26 x 1	60	HNY7226WT162W 1378	"P" Option N/A
63.5 x 19 x 1	50	HNY6319WT162W 1158	"P" Option N/A

2 Select Finish

[Click to view finishes](#)

[Click to view finishes](#)

[Click to view finishes](#)

3 Select Feet Finish

4 Select Edge

[Click to view details](#)

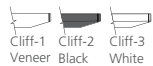

Product Features

- 1" Thick top
- Bar height 42", desk height 29"
- Ships KD
- T75 worksurface wire cutout is standard on all worksurfaces.(T75D: Delete cutout is optional)

Notes

- PANELS NOT INCLUDED

Options

Wire Tray / Premium Metal Finish

- WMT: Wire metal tray. Mounts under top and comes standard in MFW White
- \$210

Premium Metal Finish

- Specify premium Metal Finish in Front of Price List
- Premium Metal Finish for WMT wire management tray - \$75 ea

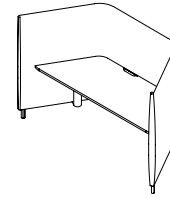

Panels
not included

[Click here to view statement of line](#)

Product Features

- "W/G" worksurfaces are 1" thick, "M" worksurfaces are 1-1/8" thick
- Lift standard in MFW White, optional MFB Black
- Ships KD
- Wire management tray attaches to worksurface top, standard in MFW White, see premium Metal Finish for options
- T75 worksurface wire cutout is standard on all worksurfaces.(T75D: Delete cutout is optional)

Notes

- 1" Gap between worksurface and panels to drop wires below worksurface
- Metal parts include 5 year warranty
- Programmable height adjustable mechanism, motor includes 2 year warranty
- Height adjustable top with mechanism and wire tray only, panels not included

Options

Premium Metal Finish

- Specify premium Metal Finish in Front of Price List
- Premium Metal Finish for WMT wire management tray - \$75 ea

1 Select Model

Weight

Standard Veneer Top

Premium Veneer Top

High Pressure Laminate Top

Thermally Fused Laminate Top

w" x d" x h"	Weight	Standard Veneer Top	Premium Veneer Top
71 x 25.5 x 1	120	HNY7125WT163W 3845	"P" Option N/A
62.5 x 18 x 1	90	HNY6218WT163W 3632	"P" Option N/A

"P" Option N/A
"P" Option N/A

HNY7125WT163G	3644
HNY6218WT163G	3468

HNY7125WT163M	3262
HNY6218WT163M	3091

2 Select Finish

[Click to view finishes](#)

[Click to view finishes](#)

[Click to view finishes](#)

3 Select Feet Finish

4 Select Edge

[Click to view details](#)





1 Select Model

Weight

w" x d" x h"	Weight	Standard Veneer Top Metal Base	Premium Veneer Top Metal Base	High Pressure Laminate Top Metal Base	Thermally Fused Laminate Top Metal Base
30 x 30 x 29	50	HNY3029TR379W 1182	"P" Option N/A	HNY3029TR379G 1182	HNY3029TR379M 946
25 x 24 x 24	45	HNY2425TR379W 1115	"P" Option N/A	HNY2425TR379G 1115	HNY2425TR379M 895
18 x 18 x 17	30	HNY1817TR379W 888	"P" Option N/A	HNY1817TR379G 888	HNY1817TR379M 683

2 Select Finish

Click to view finishes

3 Select Feet Finish

4 Select Edge

Click to view details

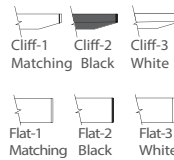
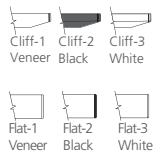

Product Features

- 1" Thick top
- Standard white metal base

Options

Premium Metal Finish - Table Base

- Specify Metal Finish for table base - \$175 each. See Front of Price List

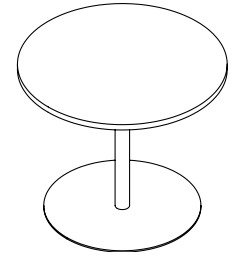

1 Select Model

Weight

w" x d" x h"	Weight	Standard Veneer Top Metal Base	Premium Veneer Top Metal Base	High Pressure Laminate Top Metal Base	Thermally Fused Laminate Top Metal Base
30 DIA x 29	50	HNY3029RD379W 1156	"P" Option N/A	HNY3029RD379G 1156	HNY3029RD379M 903
25 DIA x 24	45	HNY2425RD379W 1115	"P" Option N/A	HNY2425RD379G 1115	HNY2425RD379M 895
18 DIA x 17	30	HNY1817RD379W 925	"P" Option N/A	HNY1817RD379G 913	HNY1817RD379M 726

2 Select Finish

WWP	PO07
PM01	PO08
PM02	PO09
PM03	Click to view finishes
PM07	WBW
PM08	WSW
PM10	WOW
PO01	WNO
PO02	WSO
PO03	

GEC	LW05
GWL	LW06
LP01	
LF02	Click to view finishes
LF03	
LN01	
LA02	
LW01	
LW02	
LW04	

MOC
MEC
MSW
MTW
MWL
MNA

3 Select Feet Finish

4 Select Edge

Click to view details

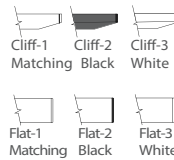
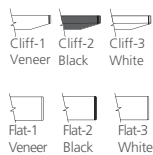

Click here to view statement of line

Product Features

- 1" Thick top
- Standard white metal base

Options

Premium Metal Finish - Table Base

- Specify Metal Finish for table base - \$175 each. See Front of Price List

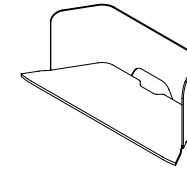

Top
not included

1 Select Model

Weight

Worksurface Screen
PET

w" x d" x h"

60 x 17 x 24

10

PS60

847

2 Select Finish

[Click to view finishes](#)

3 Select Feet Finish

4 Select acoustic color

[Click to view details](#)

[Click here to view statement of line](#)

Product Features

- Screen attaches to worksurface top
- PET Screen 1/2" thick with rounded corners
- Composed of 100% polyester fiber
- 50% post-consumer recycled content
- Adds additional acoustical absorption

Notes

- Available on both 63" and 72" worksurfaces
- Only available on Height Adjustable Worksurfaces

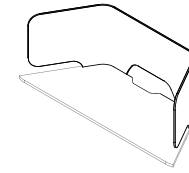

Top
not included

1 Select Model

Weight

Worksurface Screen
 Veneer Privacy Screen

w" x d" x h"

30

VS64W

2186

69 x 24 x 24

2 Select Finish

[Click to view finishes](#)

Only available in Quartered Oak and Walnut. Flat Cut veneers are not available as a standard. Maple is N/A on screens.

3 Select Feet Finish

4 Select Edge

[Click to view details](#)



Flat

[Click here to view statement of line](#)

Product Features

- Screens feature veneer on both sides with rounded corners
- 1/2" Thick screen
- Screen attaches to worksurface top

Notes

- Available on both 63" and 72" worksurfaces
- Only available on Height Adjustable Worksurfaces

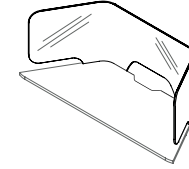

Top not included

1 Select Model

w" x d" x h"
69 x 24 x 24

Weight

20

Worksurface Screen
Frosted Acrylic

AS64AF

1539

Worksurface Screen
Matte White Acrylic

AS64AW

1607

Worksurface Screen
Matte Black Acrylic

AS64AB

1607

2 Select Finish

AF

AW

AB

3 Select Feet Finish

4 Select Edge

Click to view details



Flat



Flat



Flat

[Click here to view statement of line](#)

Product Features

- Acrylic screens with rounded corners
- 1/4" Thick screen
- Screen attaches to worksurface top

Notes

- Matte acrylic is not a writable surface
- Available on both 63" and 72" worksurfaces
- Only available on Height Adjustable Worksurfaces

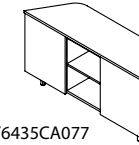

HNY6435CA077

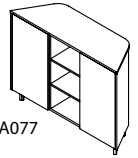

HNY6448CA077

1 Select Model

w" x d" x h"	Weight	Standard Veneer Case Solid Wood Feet	Premium Veneer Case Solid Wood Feet
64 x 20 x 48	180	HNY6448CA077W 4923	"P" Option N/A
64 x 20 x 35	140	HNY6435CA077W 4382	"P" Option N/A

2 Select Finish

Case Finishes Leg Finishes

[Click to view finishes](#)

3 Select Feet Finish

4 Select Edge

[Click to view details](#)



Flat



Flat



Flat

Case Finishes Feet Finishes Case Finishes Feet Finishes

[Click to view finishes](#)

[Click to view finishes](#)

[Click here to view statement of line](#)

Product Features

- 5" Solid wood feet - oval shape
- Dividers and shelves are finished to match case
- Sliding doors

Notes

- Not to be used as freestanding in open plan must slide into 120" panels

Options

Grommets (Vertical Surface)

- Standard location - \$50 each
- Black Plastic Vertical Surface: TM50-C (Bottom Center)
- Non-Standard Location - \$95 each
- Black Plastic Vertical Surface: TM50-NS

Premium Metal Finish

- Specify premium Metal Finish. MFMB: Matte Black, MFS: Silver, MFSS: Salmon Sienna, MFSA: Surfin Aquavert, MFPS: Pistachio, MFOS: Oyster, MFNA: Navy, MFOL: Olive, MFGB: Grey Beige MFGG: Graphite Gray, MFG: Gray
- Premium Metal Finish for MTL11 Metal Feet: \$20 ea

Metal Feet

- MTL11: Replace solid wood feet with metal feet, standard in MFW White - \$300 per wardrobe

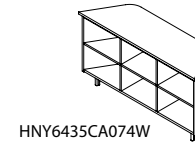

HNY6435CA074W

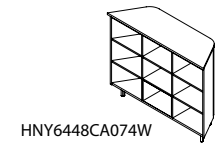

HNY6448CA074W

1 Select Model

w" x d" x h"	Weight	Standard Veneer Case Solid Wood Feet	Premium Veneer Case Solid Wood Feet
64 x 20 x 48	150	HNY6448CA074W 3671	"P" Option N/A
64 x 20 x 35	120	HNY6435CA074W 3266	"P" Option N/A

2 Select Finish

Case Finishes Leg Finishes

[Click to view finishes](#)

3 Select Feet Finish

4 Select Edge

[Click to view details](#)



Flat



Flat



Flat

High Pressure Laminate Case
Solid Wood Feet

HNY6448CA074G	3336
HNY6435CA074G	2968

Case Finishes Feet Finishes

[Click to view finishes](#)

Thermally Fused Laminate Case
Solid Wood Feet

HNY6448CA074M	2112
HNY6435CA074M	1745

Case Finishes Feet Finishes

[Click to view finishes](#)

[Click here to view statement of line](#)

Product Features

- 5" Solid wood feet - oval shape
- Dividers and shelves are finished to match case

Notes

- Not to be used as freestanding in open plan must slide into 120° panels

Options

Grommets (Vertical Surface)

- Standard location - \$50 each
- Black Plastic Vertical Surface: TM50-C (Bottom Center)
- Non-Standard Location - \$95 each
- Black Plastic Vertical Surface: TM50-NS

Premium Metal Finish

- Specify premium Metal Finish. MFMB: Matte Black, MFS: Silver, MFSS: Salmon Sienna, MFSA: Surfing Aquavert, MFPS: Pistachio, MFOS: Oyster, MFNA: Navy, MFOL: Olive, MFGB: Grey Beige MFGG: Graphite Gray, MFG: Gray
- Premium Metal Finish for MTL11 Metal Feet: \$20 ea

Metal Feet

- MTL11: Replace solid wood feet with metal feet, standard in MFW White - \$300 per wardrobe

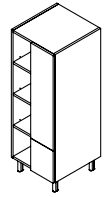

1 Select Model

Weight

Standard Veneer Case
Solid Wood Feet

Premium Veneer Case
Solid Wood Feet

High Pressure Laminate Case
Solid Wood Feet

Thermally Fused Laminate Case
Solid Wood Feet

[Click here to view statement of line](#)

Product Features

- 5" Solid wood feet - oval shape
- Three fixed open shelves, pull out drawer and wardrobe
- Dividers and shelves are finished to match case
- Full extension drawers
- Finished tops
- Soft close suspensions
- Touch latch doors

w" x d" x h"

200

HNY2055TW300W 3357

"P" Option N/A

HNY2055TW300G 3052

HNY2055TW300M 2085

20 x 20 x 55

2 Select Finish

Case Finishes Leg Finishes

Case Finishes Feet Finishes Case Finishes Feet Finishes

[Click to view finishes](#)

[Click to view finishes](#)

[Click to view finishes](#)

Options

Door

- D2: Door Lock - \$100 per door set
- D6: Delete doors - n/c
- D9SC: Soft Close Door Hinges - \$20 per door

Drawer

- P33: Wood Drawer Upgrade - \$45 per drawer
- D2: Door Lock - \$100 per door set

Premium Metal Finish

- Specify premium Metal Finish. MFMB: Matte Black, MFS: Silver, MFSS: Salmon Sienna, MFSA: Surfin Aquavert, MFPS: Pistachio, MFOS: Oyster, MFNA: Navy, MFOL: Olive, MFGB: Grey Beige MFGG: Graphite Gray, MFG: Gray
- Premium Metal Finish for MTL11 Metal Feet: \$80 per wardrobe

Metal Feet

- MTL11: Replace solid wood feet with metal feet, standard in MFW White - \$300 per wardrobe

3 Select Feet Finish

4 Select Edge

[Click to view details](#)



Flat



Flat



Flat

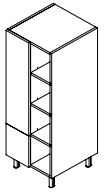

1 Select Model

w" x d" x h"
20 x 20 x 55

Weight
200

Standard Veneer Case
Solid Wood Feet

HNY2055TW301W 3357

Premium Veneer Case
Solid Wood Feet

"P" Option N/A

High Pressure Laminate Case
Solid Wood Feet

HNY2055TW301G 3052

Thermally Fused Laminate Case
Solid Wood Feet

HNY2055TW301M 2085

[Click here to view statement of line](#)

Product Features

- 5" Solid wood feet - oval shape
- Three fixed open shelves, pull out drawer and wardrobe
- Dividers and shelves are finished to match case
- Full extension drawers
- Finished tops
- Soft close suspensions
- Touch latch doors

2 Select Finish

Case Finishes Leg Finishes

[Click to view finishes](#)

Case Finishes Feet Finishes Case Finishes Feet Finishes

[Click to view finishes](#)

[Click to view finishes](#)

Options

Door

- D2: Door Lock - \$100 per door set
- D6: Delete doors - n/c
- D9SC: Soft Close Door Hinges - \$20 per door

Drawer

- P33: Wood Drawer Upgrade - \$45 per drawer
- D2: Door Lock - \$100 per door set

Premium Metal Finish

- Specify premium Metal Finish. MFMB: Matte Black, MFS: Silver, MFSS: Salmon Sienna, MFSA: Surfin Aquavert, MFPS: Pistachio, MFOS: Oyster, MFNA: Navy, MFOL: Olive, MFGB: Grey Beige MFGG: Graphite Gray, MFG: Gray
- Premium Metal Finish for MTL11 Metal Feet: \$80 per wardrobe

Metal Feet

- MTL11: Replace solid wood feet with metal feet, standard in MFW White - \$300 per wardrobe

3 Select Feet Finish

4 Select Edge

[Click to view details](#)



Flat



Flat



Flat

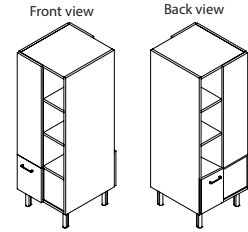

1 Select Model

w" x d" x h"
20 x 20 x 55

Weight

200



HNY2055TW299W

3866

Standard Veneer
Solid Wood Case

Premium Veneer
Solid Wood Case

High Pressure Laminate
Solid Wood Case

Thermally Fused Laminate
Solid Wood Case

"P" Option N/A

HNY2055TW299G 3514

HNY2055TW299M 2400

[Click here to view statement of line](#)

Product Features

- 5" Solid wood feet - oval shape
- Comes with three fixed shelves and pull out drawer on each side
- Full extension drawers
- Soft close suspensions
- Finished tops
- Touch latch doors

Notes

- Unit is designed for open plan use
- Sold as one unit

Options

Door

- D2: Door Lock - \$100 per door set
- D6: Delete doors - n/c
- D9SC: Soft Close Door Hinges - \$20 per door

Drawer

- P33: Wood Drawer Upgrade - \$45 per drawer
- D2: Door Lock - \$100 per door set

Premium Metal Finish

- Specify premium Metal Finish. MFMB: Matte Black, MFS: Silver, MFSS: Salmon Sienna, MFSA: Surfin Aquavert, MFPS: Pistachio, MFOS: Oyster, MFNA: Navy, MFOL: Olive, MFGB: Grey Beige MFGG: Graphite Gray, MFG: Gray
- Premium Metal Finish for MTL11 Metal Feet: \$80

Metal Feet

- MTL11: Replace solid wood feet with metal feet, standard in MFW White - \$300 per wardrobe

2 Select Finish

Case Finishes Leg Finishes

[Click to view finishes](#)

Case Finishes Feet Finishes Case Finishes Feet Finishes

[Click to view finishes](#)

[Click to view finishes](#)

3 Select Feet Finish

4 Select Edge

[Click to view details](#)



Flat



Flat



Flat

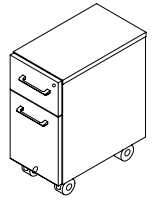

1 Select Model

w" x d" x h"
10 x 18 x 23

Weight
40

Standard Veneer Pedestal

HNY1018PD423W 1470

Premium Veneer Pedestal

"P" Option N/A

High Pressure Laminate Pedestal

HNY1018PD423G 1268

Thermally Fused Laminate Pedestal

HNY1018PD423M 1120

[Click here to view statement of line](#)

Product Features

Product features.

- 3" Hollow white wheel caster, black caster available
- Anti-tilt safety feature
- Finished all sides and top - open plan
- Full extension drawers
- Drawer lock

Options

Cushion

- BC10: Bench Cushion
- Specify fabric grade (.5 yd. required)

Drawer

- P33: Wood Drawer Upgrade - \$45 per drawer

BC10 CUSHION FABRIC GRADES.

COM	COL	1	2	3
-----	-----	---	---	---

2 Select Finish

[Click to view finishes](#)

[Click to view finishes](#)

[Click to view finishes](#)

3 Select Feet Finish

4 Select Edge

[Click to view details](#)



Flat



Flat



Flat

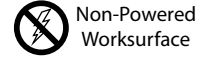

1 Select Model

Weight	Standard Veneer Top Upholstered Panels - COM\$	Premium Veneer Top Upholstered Panels - COM\$	High Pressure Laminate Top Upholstered Panels - COM\$	Thermally Fused Laminate Top Upholstered Panels - COM\$
w" x d" x h" 85 x 37 x 55	11.5	1 HNY8537HA569W 9125	"P" Option N/A	HNY8537HA569M 8503

[Click Here for Graded in Pricing](#)

2 Select Finish

Case Finishes

[Click to view finishes](#)

3 Select Feet Finish

4 Select Edge

[Click to view details](#)



Case Finishes

[Click to view finishes](#)



Case Finishes

[Click to view finishes](#)



[Click here to view statement of line](#)

Product Features

- 1" Gap between worksurface and panels to drop wires below worksurface
- Programmable height adjustable mechanism, motor includes 2 year warranty
- Wood hand rails around outside mounted on wood standoffs
- 2 locking and 2 non-locking casters. Available in BK: Black (standard) or GR: Grey (optional)
- Adjustable height from 27" to 47.5" with a maximum weight capacity of 275 lbs. Lift standard in MFW White, optional MFB Black
- HNY7125WT163 Height Adjustable worksurfaces is included
- Wire management tray attaches to worksurface top, standard in MFW White, see premium Metal Finish for options
- T75 worksurface wire cutout is standard on all worksurfaces.(T75D: Delete cutout is optional)

Options

Accessories

- K28: Articulating Keyboard w/ Mouse - \$390
- K31-SK: Center drawer w/ skirt - \$310
- K31: Center drawer w/o skirt - \$205

Casters

- 2 locking and 2 non-locking casters. Available in BK: Black (standard) or GR: Grey (optional)

Premium Metal Finish

- Specify premium Metal Finish. MFMB: Matte Black, MFS: Silver, MFSS: Salmon Sienna, MFSA: Surfing Aquavert, MFPS: Pistachio, MFOS: Oyster, MFNA: Navy, MFOL: Olive, MFGB: Grey Beige MFGG: Graphite Gray, MFG: Gray
- Premium Metal Finish for WMT Wire Management Tray - \$75 ea
- Premium Metal Finish for PCEB Concealed Floor Power Infeed Cover - \$35

Tully Inline Power

- PD-TULLY-IN-72: 2 power/dual USB up, 4 power down, 72" power cord - \$605
- PD-TULLY-IN-120: 2 power/dual USB up, 4 power down, 120" power cord - \$625

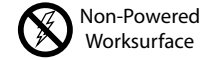
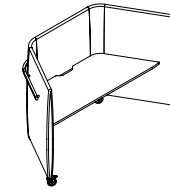

1 Select Model

Weight

Standard Veneer Top Upholstered Panels - COM\$

Premium Veneer Top Upholstered Panels - COM\$

High Pressure Laminate Top Upholstered Panels - COM\$

Thermally Fused Laminate Top Upholstered Panels - COM\$

w" x d" x h"
85 x 37 x 55

10.5

1 HNY8537FT569W 6505

"P" Option N/A

HNY8537FT569G 62897

HNY8537FT569M 5899

[Click here to view statement of line](#)

Product Features

- T75 worksurface wire cutout is standard on all worksurfaces.(T75D: Delete cutout is optional)
- Wood hand rails around outside mounted on wood standoffs
- 2 locking and 2 non-locking casters. Available in BK: Black (standard) or GR: Grey (optional)
- HNY7226WT162 Fixed Desk Height worksurfaces, 29" worksurface height
- Ships KD

Options

Accessories

- K28: Articulating Keyboard w/ Mouse - \$390
- K31-SK: Center drawer w/ skirt - \$310
- K31: Center drawer w/o skirt - \$205

Casters

- 2 locking and 2 non-locking casters. Available in BK: Black (standard) or GR: Grey (optional)

Wire Tray

- WMT: Wire metal tray. Mounts under top and comes standard in MFW White - \$210

Premium Metal Finish

- Specify premium Metal Finish. MFMB: Matte Black, MFS: Silver, MFSS: Salmon Sienna, MFSA: Surfin Aquavert, MFPS: Pistachio, MFOS: Oyster, MFNA: Navy, MFOL: Olive, MFGB: Grey Beige MFGG: Graphite Gray, MFG: Gray
- Premium Metal Finish for WMT Wire Management Tray - \$75 ea

Tully Inline Power

- PD-TULLY-IN-72: 2 power/dual USB up, 4 power down, 72" power cord - \$605
- PD-TULLY-IN-120: 2 power/dual USB up, 4 power down, 120" power cord - \$625

[Click Here for Graded in Pricing](#)

2 Select Finish

Case Finishes

[Click to view finishes](#)

Case Finishes

Leg Finishes

[Click to view finishes](#)

Case Finishes

Leg Finishes

[Click to view finishes](#)

3 Select Feet Finish

4 Select Edge

[Click to view details](#)

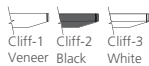



Desk and Panels
not included

Return shown in black



Non-Powered
Worksurface

Pricing for return top only

[Click here to view statement of line](#)

1 Select Model

Weight

Standard Veneer Top

Premium Veneer Top

High Pressure Laminate Top

Thermally Fused Laminate Top

Product Features

w" x d" x h"
Left Return Desk Height
42 x 24 x 1

25

HNY4224WT167W 992

"P" Option N/A

HNY4224WT167G 785

HNY4224WT167M 510

- "W/G" worksurfaces are 1" thick, "M" worksurfaces are 1-1/8" thick
- Ships KD
- Includes mounting hardware
- Bar height 42"
- Desk Height 29"
- Cannot be sold freestanding, must hook to fixed worksurface desk

Left Return Bar Height
42 x 24 x 1

25

HNY4224WT169W 992

"P" Option N/A

HNY4224WT169G 785

HNY4224WT169M 510

Notes

- PANELS NOT INCLUDED
- Desk sold separately

Options

Grommet (Standard Location)

Specify Color and Location Right/Left - \$50 ea.

- Black: TM30-R (Right), TM30-L (Left)
- Silver: TM31-R (Right), TM31-L (Left)
- White: TM34-R (Right), TM34-L (Left)

2 Select Finish

[Click to view finishes](#)

[Click to view finishes](#)

[Click to view finishes](#)

3 Select Feet Finish

4 Select Edge

[Click to view details](#)

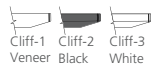

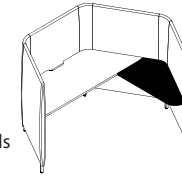

Desk and Panels
not included

Return shown in black
Pricing for return top only



Non-Powered
Worksurface

1 Select Model

Weight

Standard Veneer Top

Premium Veneer Top

High Pressure Laminate Top

Thermally Fused Laminate Top

w" x d" x h"
Right Return Desk Height
42 x 24 x 1 25

HNY4224WT168W 992

"P" Option N/A

HNY4224WT168G 785

HNY4224WT168M 510

Right Return Bar Height
42 x 24 x 1 25

HNY4224WT170W 992

"P" Option N/A

HNY4224WT170G 785

HNY4224WT170M 510

2 Select Finish

Click to view finishes

Click to view finishes

Click to view finishes

3 Select Feet Finish

4 Select Edge

Click to view details



Click here to view statement of line

Product Features

- "W/G" worksurfaces are 1" thick, "M" worksurfaces are 1-1/8" thick
- Ships KD
- Includes mounting hardware
- Bar height 42"
- Desk Height 29"
- Cannot be sold freestanding, must hook to fixed worksurface desk

Notes

- PANELS NOT INCLUDED
- Desk sold separately

Options

Grommet (Standard Location)

Specify Color and Location Right/Left - \$50 ea.

- Black: TM30-R (Right), TM30-L (Left)
- Silver: TM31-R (Right), TM31-L (Left)
- White: TM34-R (Right), TM34-L (Left)

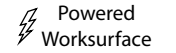
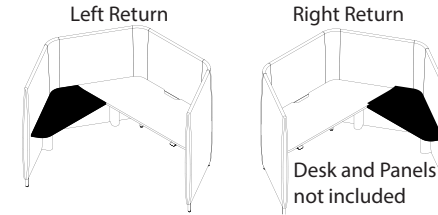

Return shown in black. Pricing for return top with lift only

[Click here to view statement of line](#)

1 Select Model

Weight

Standard Veneer Top

Premium Veneer Top

High Pressure Laminate Top

Thermally Fused Laminate Top

Product Features

w" x d" x h"

Left Return

42 x 24 x 1

25

HNY4224WT165W 1913

"P" Option N/A

HNY4224WT165G 1673

HNY4224WT165M 1525

- "W/G" worksurfaces are 1" thick, "M" worksurfaces are 1-1/8" thick
- Lift standard in MFW White, optional MFB Black
- Ships KD
- Includes mounting hardware
- Cannot be sold freestanding, must hook to lift desk

Right Return

42 x 24 x 1

25

HNY4224WT166W 1913

"P" Option N/A

HNY4224WT166G 1673

HNY4224WT166M 1525

Notes

- 1" Gap between worksurface and panels to drop wires below worksurface
- Programmable height adjustable mechanism, motor includes 2 year warranty
- Height adjustable top with mechanism and wire tray only, panels not included
- Lift desk sold separately

2 Select Finish

[Click to view finishes](#)

[Click to view finishes](#)

[Click to view finishes](#)

Options

Grommet (Standard Location)

Specify Color and Location Right/Left - \$50 ea.

- Black: TM30-R (Right), TM30-L (Left)
- Silver: TM31-R (Right), TM31-L (Left)
- White: TM34-R (Right), TM34-L (Left)

3 Select Feet Finish

4 Select Edge

[Click to view details](#)





Honey 90 Degree

Effective April 1, 2024

Designed By Mark Müller and Chris Wright

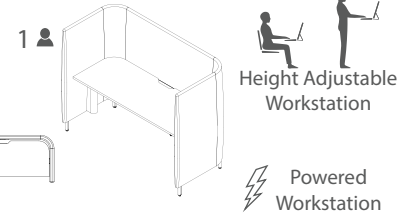
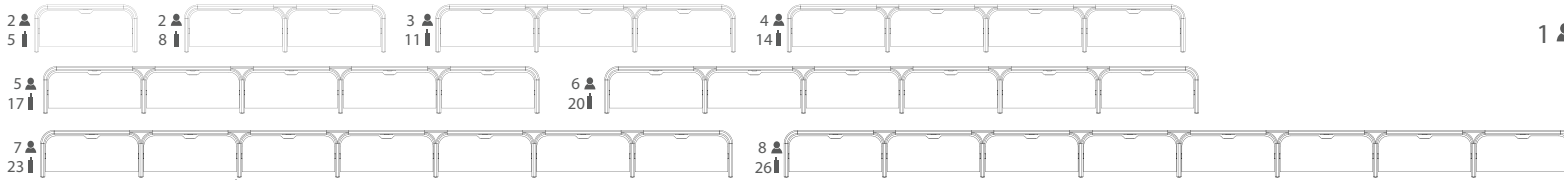

Number of Feet per Typical (MTL10 Option)

1 Select Model

Weight

w" x d" x h"	Standard Veneer Top Upholstered Panels - COM\$	Premium Veneer Top Upholstered Panels - COM\$
563 x 34 x 55	8 HNY56334HA553W 63913	"P" Option N/A
490 x 34 x 55	7 HNY49034HA553W 56098	"P" Option N/A
421 x 34 x 55	6 HNY42134HA553W 48283	"P" Option N/A
351 x 34 x 55	5 HNY35134HA553W 40468	"P" Option N/A
282 x 34 x 55	4 HNY28234HA553W 32653	"P" Option N/A
212 x 34 x 55	3 HNY21234HA553W 24838	"P" Option N/A
143 x 34 x 55	2 HNY14334HA553W 17023	"P" Option N/A
73 x 34 x 55	1 HNY7334HA553W 9208	"P" Option N/A

[Click Here for Graded in Pricing](#)

2 Select Finish

Click to view finishes

3 Select Feet Finish

4 Select Edge

Click to view details

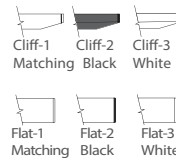
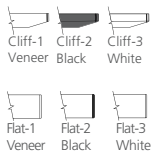

[Click here to view statement of line](#)

Product Features

- HNY6625WT163 Height Adjustable worksurfaces are included
- 5" Solid wood feet - oval shape
- 4 Power outlets with 1 telecom plate, see options below for telecom plate
- Ships KD
- Wire management tray attaches to worksurface top, standard in MFW White, see premium Metal Finish for options
- Hardwire infeed and jumpers are included in workstations
- T75 worksurface wire cutout is standard on all worksurfaces.(T75D: Delete cutout is optional)

Options

Accessories

- K28: Articulating Keyboard w/ Mouse - \$390
- K31-SK: Center drawer w/ skirt - \$310
- K31: Center drawer w/o skirt - \$205

Concealed Floor Power Infeed Cover

- PCEB: White Metal Finish concealed floor power infeed cover - \$150

Delete Top and Wire Tray

- DHAT: Delete height adjustable top. Deduct \$3845 Veneer(W), \$3644 High Pressure Laminate(G), \$3262 Thermally Fused Laminate(M) per top

Metal Feet

- MTL10: Replace solid wood feet with metal feet, standard MFW White - \$55 ea

Premium Metal Finish

- See Front of Price List for Premium Metal Finish Options
- Premium Metal Finish for WMT Wire Management Tray - \$75 ea
- Premium Metal Finish for MTL10 Metal Feet - \$20 ea
- Premium Metal Finish for PCEB Concealed Floor Power Infeed Cover - \$35

Telecom Plates

- Each power unit has 1 plate. All telecom connectors sold separately.
- RJ45 (1) - \$55, RJ45 (2) - \$110, RJ45 (3) - \$165, USB (1) - \$70, USB (2) - \$140, RJ45/USB - \$125, RJ45/HDMI - \$210, HDMI/USB - \$205

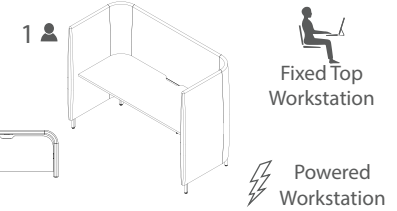
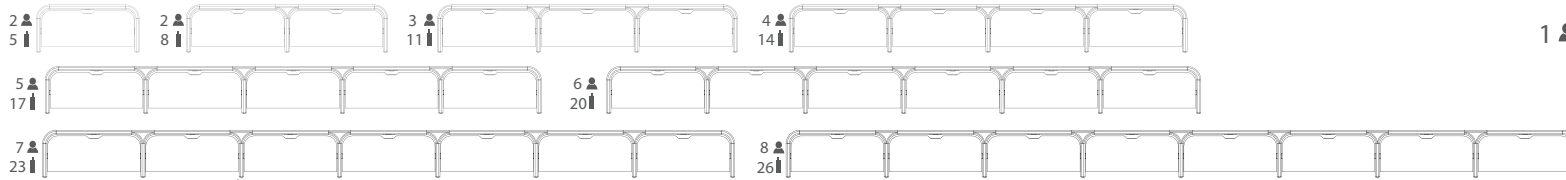

Number of Feet per Typical (MTL10 Option)

1 Select Model

Weight

Standard Veneer Top Upholstered Panels - COM\$

Premium Veneer Top Upholstered Panels - COM\$

High Pressure Laminate Top Upholstered Panels - COM\$

Thermally Fused Laminate Top Upholstered Panels - COM\$

563 x 34 x 55	8	HNY56334FP553W	44177
490 x 34 x 55	7	HNY49034FP553W	38829
421 x 34 x 55	6	HNY42134FP553W	33481
351 x 34 x 55	5	HNY35134FP553W	28133
282 x 34 x 55	4	HNY28234FP553W	22785
212 x 34 x 55	3	HNY21234FP553W	17437
143 x 34 x 55	2	HNY14334FP553W	12089
73 x 34 x 55	1	HNY7334FP553W	6741

"P" Option N/A
"P" Option N/A
"P" Option N/A
"P" Option N/A
"P" Option N/A
"P" Option N/A
"P" Option N/A
"P" Option N/A

HNY56334FP553G	42513
HNY49034FP553G	37373
HNY42134FP553G	32233
HNY35134FP553G	27093
HNY28234FP553G	21953
HNY21234FP553G	16813
HNY14334FP553G	11673
HNY7334FP553G	6533

HNY56334FP553M	39337
HNY49034FP553M	34594
HNY42134FP553M	29851
HNY35134FP553M	25108
HNY28234FP553M	20365
HNY21234FP553M	15622
HNY14334FP553M	10879
HNY7334FP553M	6136

Product Features

- HNY6625WT162 Fixed Desk Height Worksurfaces are included
- 5" Solid wood feet - oval shape
- 4 Power outlets with 1 telecom plate, see options below for telecom plate
- Ships KD
- Wire management tray attaches to worksurface top, standard in MFW White, see premium Metal Finish for options
- Hardwire infeed and jumpers are included in workstations
- T75 worksurface wire cutout is standard on all worksurfaces.(T75D: Delete cutout is optional)

Options

Accessories

- K28: Articulating Keyboard w/ Mouse - \$390
- K31-SK: Center drawer w/ skirt - \$310
- K31: Center drawer w/o skirt - \$205

Concealed Floor Power Infeed Cover

- PCEB: White Metal Finish concealed floor power infeed cover - \$150

Delete Top and Wire Tray

- DFP: Delete fixed top. Deduct \$1535 Veneer (W), \$1335 High Pressure Laminate (G), \$953 Thermally Fused Laminate (M) per top

Metal Feet

- MTL10: Replace solid wood feet with metal feet, standard MFW White - \$55 ea

Premium Metal Finish

- See Front of Price List for Premium Metal Finish Options
- Premium Metal Finish for WMT Wire Management Tray - \$75 ea
- Premium Metal Finish for MTL10 Metal Feet - \$20 ea
- Premium Metal Finish for PCEB Concealed Floor Power Infeed Cover - \$35

Telecom Plates

- Each power unit has 1 plate. All telecom connectors sold separately.
- RJ45 (1) - \$55, RJ45 (2) - \$110, RJ45 (3) - \$165, USB (1) - \$70, USB (2) - \$140, RJ45/USB - \$125, RJ45/HDMI - \$210, HDMI/USB - \$205

Worksurface Height

- THL-42: Modify worksurface height to bar height - N/C

[Click Here for Graded in Pricing](#)

2 Select Finish

[Click to view finishes](#)

[Click to view finishes](#)

[Click to view finishes](#)

3 Select Feet Finish

4 Select Edge

[Click to view details](#)

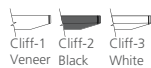

DARRAN

Honey

Inline 90° Workstation Typical
Position 3 Desk with Height Adjustable Worksurface

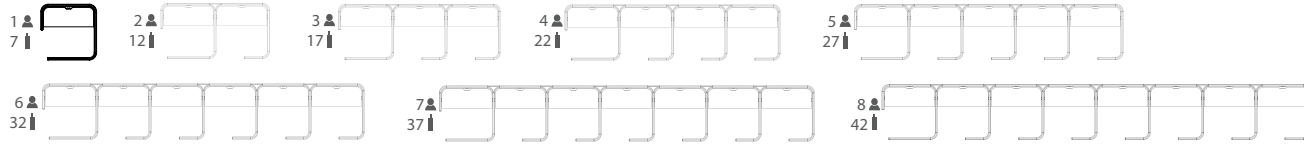

Number of Feet per Typical (MTL10 Option)

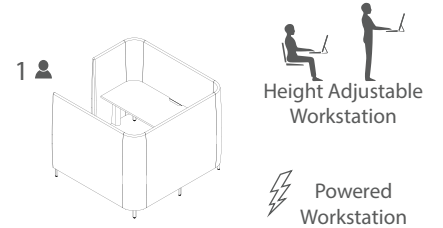

1 Select Model

Weight

Standard Veneer Top Upholstered Panels - COM\$

Premium Veneer Top Upholstered Panels - COM\$

High Pressure Laminate Top Upholstered Panels - COM\$

Thermally Fused Laminate Top Upholstered Panels - COM\$

560 x 73 x 55	8 people HNY56073HA555W	80964
491 x 73 x 55	7 people HNY49173HA555W	71074
421 x 73 x 55	6 people HNY42173HA555W	61184
352 x 73 x 55	5 people HNY35273HA555W	51294
282 x 73 x 55	4 people HNY28273HA555W	41404
212 x 73 x 55	3 people HNY21273HA555W	31514
143 x 73 x 55	2 people HNY14373HA555W	21624
73 x 73 x 55	1 person HNY7373HA555W	11734

"P" Option N/A
 "P" Option N/A
 "P" Option N/A
 "P" Option N/A
 "P" Option N/A
 "P" Option N/A
 "P" Option N/A
 "P" Option N/A

HNY56073HA555G	79356
HNY49173HA555G	69667
HNY42173HA555G	59978
HNY35273HA555G	50289
HNY28273HA555G	40600
HNY21273HA555G	30911
HNY14373HA555G	21222
HNY7373HA555G	11533

HNY56073HA555M	76300
HNY49173HA555M	66993
HNY42173HA555M	57686
HNY35273HA555M	48379
HNY28273HA555M	39072
HNY21273HA555M	29765
HNY14373HA555M	20458
HNY7373HA555M	11151

[Click Here for Graded in Pricing](#)

2 Select Finish

Click to view finishes

Click to view finishes

Click to view finishes

3 Select Feet Finish

4 Select Edge

Click to view details

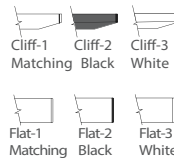
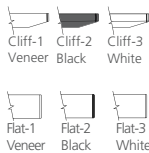

[Click here to view statement of line](#)

Product Features

- HNY6625WT163 Height Adjustable worksurfaces are included
- 5" Solid wood feet - oval shape
- 4 Power outlets with 1 telecom plate, see options below for telecom plate
- Ships KD
- Wire management tray attaches to worksurface top, standard in MFW White, see premium Metal Finish for options
- Hardwire infeed and jumpers are included in workstations
- T75 worksurface wire cutout is standard on all worksurfaces.(T75D: Delete cutout is optional)

Options

Accessories

- K28: Articulating Keyboard w/ Mouse - \$390
- K31-SK: Center drawer w/ skirt - \$310
- K31: Center drawer w/o skirt - \$205

Concealed Floor Power Infeed Cover

- PCEB: White Metal Finish concealed floor power infeed cover - \$150

Delete Top and Wire Tray

- DHAT: Delete height adjustable top. Deduct \$3845 Veneer(W), \$3644 High Pressure Laminate(G), \$3262 Thermally Fused Laminate(M) per top

Metal Feet

- MTL10: Replace solid wood feet with metal feet, standard MFW White - \$55 ea

Premium Metal Finish

- See Front of Price List for Premium Metal Finish Options
- Premium Metal Finish for WMT Wire Management Tray - \$75 ea
- Premium Metal Finish for MTL10 Metal Feet - \$20 ea
- Premium Metal Finish for PCEB Concealed Floor Power Infeed Cover - \$35

Telecom Plates

- Each power unit has 1 plate. All telecom connectors sold separately.
- RJ45 (1) - \$55, RJ45 (2) - \$110, RJ45 (3) - \$165, USB (1) - \$70, USB (2) - \$140, RJ45/USB - \$125, RJ45/HDMI - \$210, HDMI/USB - \$205

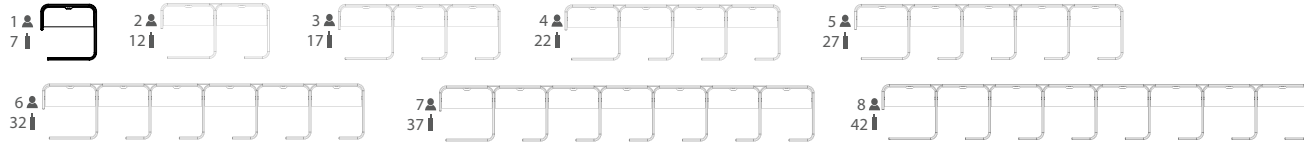

Number of Feet per Typical (MTL10 Option)

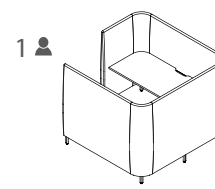

Fixed Top Workstation

Powered Workstation

1 Select Model

Weight

Standard Veneer Top Upholstered Panels - COM\$

Premium Veneer Top Upholstered Panels - COM\$

High Pressure Laminate Top Upholstered Panels - COM\$

Thermally Fused Laminate Top Upholstered Panels - COM\$

w" x d" x h"	Weight	Standard Veneer Top Upholstered Panels - COM\$
560 x 73 x 55	8	HNY56073FP555W 61228
491 x 73 x 55	7	HNY49173FP555W 53805
421 x 73 x 55	6	HNY42173FP555W 46382
352 x 73 x 55	5	HNY35273FP555W 38959
282 x 73 x 55	4	HNY28273FP555W 31536
212 x 73 x 55	3	HNY21273FP555W 24113
143 x 73 x 55	2	HNY14373FP555W 16690
73 x 73 x 55	1	HNY7373FP555W 9267

"P" Option N/A	
"P" Option N/A	
"P" Option N/A	
"P" Option N/A	
"P" Option N/A	
"P" Option N/A	
"P" Option N/A	
"P" Option N/A	
"P" Option N/A	

HNY56073FP555G	59564
HNY49173FP555G	52349
HNY42173FP555G	45134
HNY35273FP555G	37919
HNY28273FP555G	30704
HNY21273FP555G	23489
HNY14373FP555G	16274
HNY7373FP555G	9059

HNY56073FP555M	56388
HNY49173FP555M	49570
HNY42173FP555M	42752
HNY35273FP555M	35934
HNY28273FP555M	29116
HNY21273FP555M	22298
HNY14373FP555M	15480
HNY7373FP555M	8662

[Click here to view statement of line](#)

Product Features

- HNY6625WT162 Fixed Desk Height Worksurfaces are included
- 5" Solid wood feet - oval shape
- 4 Power outlets with 1 telecom plate, see options below for telecom plate
- Ships KD
- Wire management tray attaches to worksurface top, standard in MFW White, see premium Metal Finish for options
- Hardwire infeed and jumpers are included in workstations
- T75 worksurface wire cutout is standard on all worksurfaces.(T75D: Delete cutout is optional)

[Click Here for Graded in Pricing](#)

2 Select Finish

[Click to view finishes](#)

[Click to view finishes](#)

[Click to view finishes](#)

3 Select Feet Finish

4 Select Edge

[Click to view details](#)



Options

Accessories

- K28: Articulating Keyboard w/ Mouse - \$390
- K31-SK: Center drawer w/ skirt - \$310
- K31: Center drawer w/o skirt - \$205

Concealed Floor Power Infeed Cover

- PCEB: White Metal Finish concealed floor power infeed cover - \$150

Delete Top and Wire Tray

- DFP: Delete fixed top. Deduct \$1535 Veneer (W), \$1335 High Pressure Laminate (G), \$953 Thermally Fused Laminate (M) per top

Metal Feet

- MTL10: Replace solid wood feet with metal feet, standard MFW White - \$55 ea

Premium Metal Finish

- See Front of Price List for Premium Metal Finish Options
- Premium Metal Finish for WMT Wire Management Tray - \$75 ea
- Premium Metal Finish for MTL10 Metal Feet - \$20 ea
- Premium Metal Finish for PCEB Concealed Floor Power Infeed Cover - \$35

Telecom Plates

- Each power unit has 1 plate. All telecom connectors sold separately.
- RJ45 (1) - \$55, RJ45 (2) - \$110, RJ45 (3) - \$165, USB (1) - \$70, USB (2) - \$140, RJ45/USB - \$125, RJ45/HDMI - \$210, HDMI/USB - \$205

Worksurface Height

- THL-42: Modify worksurface height to bar height - N/C

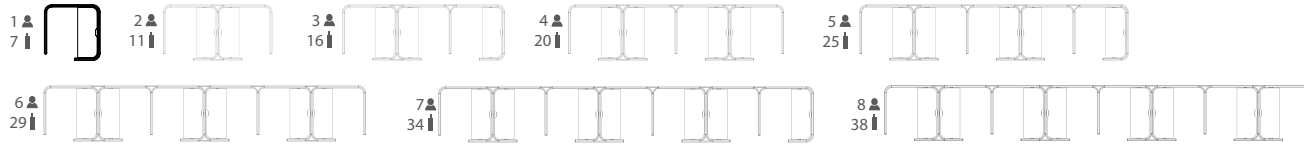

Number of Feet per Typical (MTL10 Option)

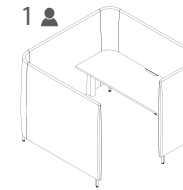

Height Adjustable Workstation

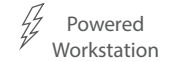

Powered Workstation

1 Select Model

Weight

Standard Veneer Top Upholstered Panels - COM\$

Premium Veneer Top Upholstered Panels - COM\$

High Pressure Laminate Top Upholstered Panels - COM\$

Thermally Fused Laminate Top Upholstered Panels - COM\$

560 x 73 x 55	8	HNY56073HA556W	77364
491 x 73 x 55	7	HNY49173HA556W	68509
421 x 73 x 55	6	HNY42173HA556W	58439
352 X 73 X 55	5	HNY35273HA556W	49584
282 x 73 x 55	4	HNY28273HA556W	39514
212 x 73 x 55	3	HNY21273HA556W	30659
143 x 73 x 55	2	HNY14373HA556W	20589
73 x 73 x 55	1	HNY7373HA556W	11734

"P" Option N/A
"P" Option N/A
"P" Option N/A
"P" Option N/A
"P" Option N/A
"P" Option N/A
"P" Option N/A
"P" Option N/A

HNY56073HA556G	75756
HNY49173HA556G	67102
HNY42173HA556G	57233
HNY35273HA556G	48579
HNY28273HA556G	38710
HNY21273HA556G	30056
HNY14373HA556G	20187
HNY7373HA556G	11533

HNY56073HA556M	72700
HNY49173HA556M	64428
HNY42173HA556M	54941
HNY35273HA556M	46669
HNY28273HA556M	37182
HNY21273HA556M	28910
HNY14373HA556M	19423
HNY7373HA556M	11151

[Click Here for Graded in Pricing](#)

2 Select Finish

[Click to view finishes](#)

[Click to view finishes](#)

[Click to view finishes](#)

3 Select Feet Finish

4 Select Edge

[Click to view details](#)



[Click here to view statement of line](#)

Product Features

- HNY6625WT163 Height Adjustable worksurfaces are included
- 5" Solid wood feet - oval shape
- 4 Power outlets with 1 telecom plate, see options below for telecom plate
- Ships KD
- Wire management tray attaches to worksurface top, standard in MFW White, see premium Metal Finish for options
- Hardwire infeed and jumpers are included in workstations
- T75 worksurface wire cutout is standard on all worksurfaces.(T75D: Delete cutout is optional)

Options

Accessories

- K28: Articulating Keyboard w/ Mouse - \$390
- K31-SK: Center drawer w/ skirt - \$310
- K31: Center drawer w/o skirt - \$205

Concealed Floor Power Infeed Cover

- PCEB: White Metal Finish concealed floor power infeed cover - \$150

Delete Top and Wire Tray

- DHAT: Delete height adjustable top. Deduct \$3845 Veneer(W), \$3644 High Pressure Laminate(G), \$3262 Thermally Fused Laminate(M) per top

Metal Feet

- MTL10: Replace solid wood feet with metal feet, standard MFW White - \$55 ea

Premium Metal Finish

- See Front of Price List for Premium Metal Finish Options
- Premium Metal Finish for WMT Wire Management Tray - \$75 ea
- Premium Metal Finish for MTL10 Metal Feet - \$20 ea
- Premium Metal Finish for PCEB Concealed Floor Power Infeed Cover - \$35

Telecom Plates

- Each power unit has 1 plate. All telecom connectors sold separately.
- RJ45 (1) - \$55, RJ45 (2) - \$110, RJ45 (3) - \$165, USB (1) - \$70, USB (2) - \$140, RJ45/USB - \$125, RJ45/HDMI - \$210, HDMI/USB - \$205

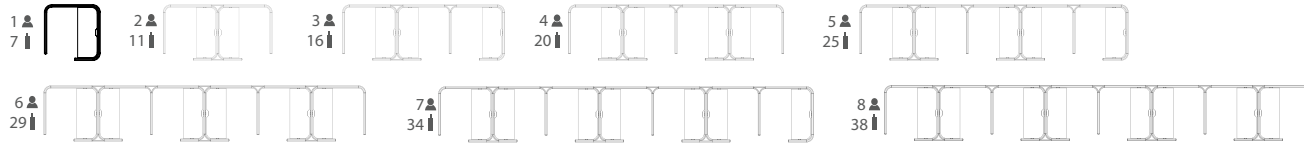

Number of Feet per Typical (MTL10 Option)

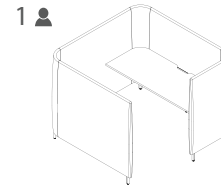

Fixed Top Workstation
Powered Workstation

1 Select Model

Weight

Standard Veneer Top Upholstered Panels - COM\$

Premium Veneer Top Upholstered Panels - COM\$

High Pressure Laminate Top Upholstered Panels - COM\$

Thermally Fused Laminate Top Upholstered Panels - COM\$

560 x 73 x 55	8	HNY56073FP556W	57628
491 x 73 x 55	7	HNY49173FP556W	51240
421 x 73 x 55	6	HNY42173FP556W	43637
352 x 73 x 55	5	HNY35273FP556W	37249
282 x 73 x 55	4	HNY28273FP556W	29646
212 x 73 x 55	3	HNY21273FP556W	23258
143 x 73 x 55	2	HNY14373FP556W	15655
73 x 73 x 55	1	HNY7373FP556W	9267

"P" Option N/A
"P" Option N/A
"P" Option N/A
"P" Option N/A
"P" Option N/A
"P" Option N/A
"P" Option N/A
"P" Option N/A

HNY56073FP556G	55964
HNY49173FP556G	49784
HNY42173FP556G	42389
HNY35273FP556G	36209
HNY28273FP556G	28814
HNY21273FP556G	22634
HNY14373FP556G	15239
HNY7373FP556G	9059

HNY56073FP556M	52788
HNY49173FP556M	47005
HNY42173FP556M	40007
HNY35273FP556M	34224
HNY28273FP556M	27226
HNY21273FP556M	21443
HNY14373FP556M	14445
HNY7373FP556M	8662

Click here to view statement of line

Product Features

- HNY6625WT162 Fixed Desk Height Worksurfaces are included
- 5" Solid wood feet - oval shape
- 4 Power outlets with 1 telecom plate, see options below for telecom plate
- Ships KD
- Wire management tray attaches to worksurface top, standard in MFW White, see premium Metal Finish for options
- Hardwire infeed and jumpers are included in workstations
- T75 worksurface wire cutout is standard on all worksurfaces.(T75D: Delete cutout is optional)

[Click Here for Graded in Pricing](#)

2 Select Finish

Click to view finishes

Click to view finishes

Click to view finishes

3 Select Feet Finish

4 Select Edge

Click to view details

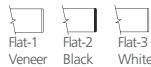

Options

Accessories

- K28: Articulating Keyboard w/ Mouse - \$390
- K31-SK: Center drawer w/ skirt - \$310
- K31: Center drawer w/o skirt - \$205

Concealed Floor Power Infeed Cover

- PCEB: White Metal Finish concealed floor power infeed cover - \$150

Delete Top and Wire Tray

- DFP: Delete fixed top. Deduct \$1535 Veneer (W), \$1335 High Pressure Laminate (G), \$953 Thermally Fused Laminate (M) per top

Metal Feet

- MTL10: Replace solid wood feet with metal feet, standard MFW White - \$55 ea

Premium Metal Finish

- See Front of Price List for Premium Metal Finish Options
- Premium Metal Finish for WMT Wire Management Tray - \$75 ea
- Premium Metal Finish for MTL10 Metal Feet - \$20 ea
- Premium Metal Finish for PCEB Concealed Floor Power Infeed Cover - \$35

Telecom Plates

- Each power unit has 1 plate. All telecom connectors sold separately.
- RJ45 (1) - \$55, RJ45 (2) - \$110, RJ45 (3) - \$165, USB (1) - \$70, USB (2) - \$140, RJ45/USB - \$125, RJ45/HDMI - \$210, HDMI/USB - \$205

Worksurface Height

- THL-42: Modify worksurface height to bar height - N/C



Number of Feet per Typical (MTL10 Option)

1 Select Model

Weight

Standard Veneer Top Upholstered Panels - COM\$

Premium Veneer Top Upholstered Panels - COM\$

High Pressure Laminate Top Upholstered Panels - COM\$

Thermally Fused Laminate Top Upholstered Panels - COM\$

w" x d" x h"	Weight	Price
282 x 64 x 55	8 HNY28264HA560W	54393
212 x 64 x 55	6 HNY21264HA560W	41441
143 x 64 x 55	4 HNY14364HA560W	28489
73 x 64 x 55	2 HNY7364HA560W	15537

"P" Option N/A
"P" Option N/A
"P" Option N/A
"P" Option N/A

HNY28264HA560G	52785
HNY21264HA560G	40235
HNY14364HA560G	27685
HNY7364HA560G	15135

HNY28264HA560M	49729
HNY21264HA560M	37943
HNY14364HA560M	26157
HNY7364HA560M	14371

[Click here to view statement of line](#)

Product Features

- HNY6625WT163 Height Adjustable worksurfaces are included
- 5" Solid wood feet - oval shape
- 4 Power outlets with 1 telecom plate, see options below for telecom plate
- Ships KD
- Wire management tray attaches to worksurface top, standard in MFW White, see premium Metal Finish for options
- Hardwire infeed and jumpers are included in workstations
- T75 worksurface wire cutout is standard on all worksurfaces.(T75D: Delete cutout is optional)

Options

Accessories

- K28: Articulating Keyboard w/ Mouse - \$390
- K31-SK: Center drawer w/ skirt - \$310
- K31: Center drawer w/o skirt - \$205

Concealed Floor Power Infeed Cover

- PCEB: White Metal Finish concealed floor power infeed cover - \$150

Delete Top and Wire Tray

- DHAT: Delete height adjustable top. Deduct \$3845 Veneer(W), \$3644 High Pressure Laminate(G), \$3262 Thermally Fused Laminate(M) per top

Metal Feet

- MTL10: Replace solid wood feet with metal feet, standard MFW White - \$55 ea

Premium Metal Finish

- See Front of Price List for Premium Metal Finish Options
- Premium Metal Finish for WMT Wire Management Tray - \$75 ea
- Premium Metal Finish for MTL10 Metal Feet - \$20 ea
- Premium Metal Finish for PCEB Concealed Floor Power Infeed Cover - \$35

Telecom Plates

- Each power unit has 1 plate. All telecom connectors sold separately.
- RJ45 (1) - \$55, RJ45 (2) - \$110, RJ45 (3) - \$165, USB (1) - \$70, USB (2) - \$140, RJ45/USB - \$125, RJ45/HDMI - \$210, HDMI/USB - \$205

[Click Here for Graded in Pricing](#)

2 Select Finish

[Click to view finishes](#)

[Click to view finishes](#)

[Click to view finishes](#)

3 Select Feet Finish

4 Select Edge

[Click to view details](#)

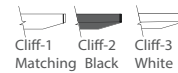

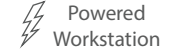
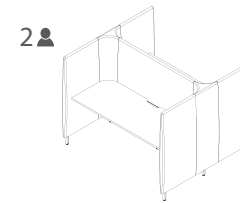

Number of Feet per Typical (MTL10 Option)

1 Select Model

Weight

Standard Veneer Top Upholstered Panels - COM\$

Premium Veneer Top Upholstered Panels - COM\$

High Pressure Laminate Top Upholstered Panels - COM\$

Thermally Fused Laminate Top Upholstered Panels - COM\$

w" x d" x h"	Weight	Standard Veneer Top Upholstered Panels - COM\$
282 x 64 x 55	8	HNY28264FP560W 34657
212 x 64 x 55	6	HNY21264FP560W 26639
143 x 64 x 55	4	HNY14364FP560W 18621
73 x 64 x 55	2	HNY7364FP560W 10602

"P" Option N/A
"P" Option N/A
"P" Option N/A
"P" Option N/A

HNY28264FP560G	32993
HNY21264FP560G	25391
HNY14364FP560G	17789
HNY7364FP560G	10186

HNY28264FP560M	29817
HNY21264FP560M	23009
HNY14364FP560M	16201
HNY7364FP560M	9392

[Click here to view statement of line](#)

Product Features

- HNY6625WT162 Fixed Desk Height Worksurfaces are included
- 5" Solid wood feet - oval shape
- 4 Power outlets with 1 telecom plate, see options below for telecom plate
- Ships KD
- Wire management tray attaches to worksurface top, standard in MFW White, see premium Metal Finish for options
- Hardwire infeed and jumpers are included in workstations
- T75 worksurface wire cutout is standard on all worksurfaces.(T75D: Delete cutout is optional)

[Click Here for Graded in Pricing](#)

2 Select Finish

[Click to view finishes](#)

[Click to view finishes](#)

[Click to view finishes](#)

Options

Accessories

- K28: Articulating Keyboard w/ Mouse - \$390
- K31-SK: Center drawer w/ skirt - \$310
- K31: Center drawer w/o skirt - \$205

Concealed Floor Power Infeed Cover

- PCEB: White Metal Finish concealed floor power infeed cover - \$150

Delete Top and Wire Tray

- DFP: Delete fixed top. Deduct \$1535 Veneer (W), \$1335 High Pressure Laminate (G), \$953 Thermally Fused Laminate (M) per top

Metal Feet

- MTL10: Replace solid wood feet with metal feet, standard MFW White - \$55 ea

Premium Metal Finish

- See Front of Price List for Premium Metal Finish Options
- Premium Metal Finish for WMT Wire Management Tray - \$75 ea
- Premium Metal Finish for MTL10 Metal Feet - \$20 ea
- Premium Metal Finish for PCEB Concealed Floor Power Infeed Cover - \$35

Telecom Plates

- Each power unit has 1 plate. All telecom connectors sold separately.
- RJ45 (1) - \$55, RJ45 (2) - \$110, RJ45 (3) - \$165, USB (1) - \$70, USB (2) - \$140, RJ45/USB - \$125, RJ45/HDMI - \$210, HDMI/USB - \$205
- THL-42: Modify worksurface height to bar height - N/C

4 Select Edge

[Click to view details](#)



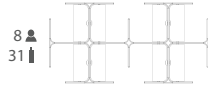

Number of Feet per Typical (MTL10 Option)

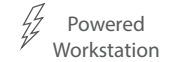
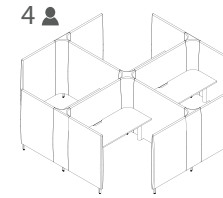

1 Select Model

Weight

w" x d" x h"
282 x 143 x 55
143 x 143 x 55

Standard Veneer Top
Upholstered Panels - COM\$
8 HNY282143HA563W 67593
4 HNY143143HA563W 34983

Premium Veneer Top
Upholstered Panels - COM\$
"P" Option N/A
"P" Option N/A

High Pressure Laminate Top
Upholstered Panels - COM\$
HNY282143HA563G 65985
HNY143143HA563G 34179

Thermally Fused Laminate Top
Upholstered Panels - COM\$
HNY282143HA563M 62929
HNY143143HA563M 32651

[Click here to view statement of line](#)

Product Features

- HNY6625WT163 Height Adjustable worksurfaces are included
- 5" Solid wood feet - oval shape
- 4 Power outlets with 1 telecom plate, see options below for telecom plate
- Ships KD
- Wire management tray attaches to worksurface top, standard in MFW White, see premium Metal Finish for options
- Hardwire infeed and jumpers are included in workstations
- T75 worksurface wire cutout is standard on all worksurfaces.(T75D: Delete cutout is optional)

Options

Accessories

- K28: Articulating Keyboard w/ Mouse - \$390
- K31-SK: Center drawer w/ skirt - \$310
- K31: Center drawer w/o skirt - \$205

Concealed Floor Power Infeed Cover

- PCEB: White Metal Finish concealed floor power infeed cover - \$150

Delete Top and Wire Tray

- DHAT: Delete height adjustable top. Deduct \$3845 Veneer(W), \$3644 High Pressure Laminate(G), \$3262 Thermally Fused Laminate(M) per top

Metal Feet

- MTL10: Replace solid wood feet with metal feet, standard MFW White - \$55 ea

Premium Metal Finish

- See Front of Price List for Premium Metal Finish Options
- Premium Metal Finish for WMT Wire Management Tray - \$75 ea
- Premium Metal Finish for MTL10 Metal Feet - \$20 ea
- Premium Metal Finish for PCEB Concealed Floor Power Infeed Cover - \$35

Telecom Plates

- Each power unit has 1 plate. All telecom connectors sold separately.
- RJ45 (1) - \$55, RJ45 (2) - \$110, RJ45 (3) - \$165, USB (1) - \$70, USB (2) - \$140, RJ45/USB - \$125, RJ45/HDMI - \$210, HDMI/USB - \$205

[Click Here for Graded in Pricing](#)

2 Select Finish

[Click to view finishes](#)

[Click to view finishes](#)

[Click to view finishes](#)

3 Select Feet Finish

4 Select Edge

[Click to view details](#)



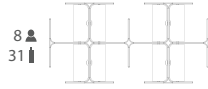

Number of Feet per Typical (MTL10 Option)

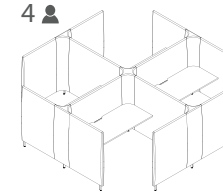

1 Select Model

Weight

w" x d" x h"
282 x 143 x 55
143 x 143 x 55

Standard Veneer Top
Upholstered Panels - COM\$
8 HNY282143FP563W 47857
4 HNY143143FP563W 25115

Premium Veneer Top
Upholstered Panels - COM\$
"P" Option N/A
"P" Option N/A

High Pressure Laminate Top
Upholstered Panels - COM\$
HNY282143FP563G 46193
HNY143143FP563G 24283

Thermally Fused Laminate Top
Upholstered Panels - COM\$
HNY282143FP563M 43017
HNY143143FP563M 22695

[Click here to view statement of line](#)

Product Features

- HNY6625WT163 Height Adjustable worksurfaces are included
- 5" Solid wood feet - oval shape
- 4 Power outlets with 1 telecom plate, see options below for telecom plate
- Ships KD
- Wire management tray attaches to worksurface top, standard in MFW White, see premium Metal Finish for options
- Hardwire infeed and jumpers are included in workstations
- T75 worksurface wire cutout is standard on all worksurfaces.(T75D: Delete cutout is optional)

[Click Here for Graded in Pricing](#)

2 Select Finish

[Click to view finishes](#)

[Click to view finishes](#)

[Click to view finishes](#)

3 Select Feet Finish

4 Select Edge

[Click to view details](#)



Options

Accessories

- K28: Articulating Keyboard w/ Mouse - \$390
- K31-SK: Center drawer w/ skirt - \$310
- K31: Center drawer w/o skirt - \$205

Concealed Floor Power Infeed Cover

- PCEB: White Metal Finish concealed floor power infeed cover - \$150

Delete Top and Wire Tray

- DHAT: Delete height adjustable top. Deduct \$3845 Veneer(W), \$3644 High Pressure Laminate(G), \$3262 Thermally Fused Laminate(M) per top

Metal Feet

- MTL10: Replace solid wood feet with metal feet, standard MFW White - \$55 ea

Premium Metal Finish

- See Front of Price List for Premium Metal Finish Options
- Premium Metal Finish for WMT Wire Management Tray - \$75 ea
- Premium Metal Finish for MTL10 Metal Feet - \$20 ea
- Premium Metal Finish for PCEB Concealed Floor Power Infeed Cover - \$35

Telecom Plates

- Each power unit has 1 plate. All telecom connectors sold separately.
- RJ45 (1) - \$55, RJ45 (2) - \$110, RJ45 (3) - \$165, USB (1) - \$70, USB (2) - \$140, RJ45/USB - \$125, RJ45/HDMI - \$210, HDMI/USB - \$205

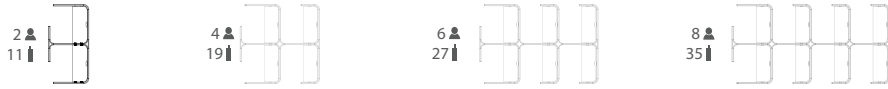

Number of Feet per Typical (MTL10 Option)

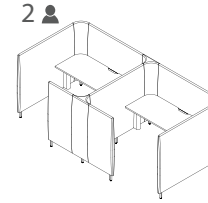

1 Select Model

Weight

w" x d" x h"
282 x 143 x 55
212 x 143 x 55
143 x 143 x 55
73 x 143 x 55

Standard Veneer Top
Upholstered Panels - COM\$

8 HNY282143HA562W 73943
6 HNY212143HA562W 56374
4 HNY143143HA562W 38805
2 HNY73143HA562W 21236

Premium Veneer Top
Upholstered Panels - COM\$

"P" Option N/A
"P" Option N/A
"P" Option N/A
"P" Option N/A

High Pressure Laminate Top
Upholstered Panels - COM\$

HNY282143HA562G 72335
HNY212143HA562G 55168
HNY143143HA562G 38001
HNY73143HA562G 20834

Thermally Fused Laminate Top
Upholstered Panels - COM\$

HNY282143HA562M 69279
HNY212143HA562M 52876
HNY143143HA562M 36473
HNY73143HA562M 20070

[Click here to view statement of line](#)

Product Features

- HNY6625WT163 Height Adjustable worksurfaces are included
- 5" Solid wood feet - oval shape
- 4 Power outlets with 1 telecom plate, see options below for telecom plate
- Ships KD
- Wire management tray attaches to worksurface top, standard in MFW White, see premium Metal Finish for options
- Hardwire infeed and jumpers are included in workstations
- T75 worksurface wire cutout is standard on all worksurfaces.(T75D: Delete cutout is optional)

Options

Accessories

- K28: Articulating Keyboard w/ Mouse - \$390
- K31-SK: Center drawer w/ skirt - \$310
- K31: Center drawer w/o skirt - \$205

Concealed Floor Power Infeed Cover

- PCEB: White Metal Finish concealed floor power infeed cover - \$150

Delete Top and Wire Tray

- DHAT: Delete height adjustable top. Deduct \$3845 Veneer(W), \$3644 High Pressure Laminate(G), \$3262 Thermally Fused Laminate(M) per top

Metal Feet

- MTL10: Replace solid wood feet with metal feet, standard MFW White - \$55 ea

Premium Metal Finish

- See Front of Price List for Premium Metal Finish Options
- Premium Metal Finish for WMT Wire Management Tray - \$75 ea
- Premium Metal Finish for MTL10 Metal Feet - \$20 ea
- Premium Metal Finish for PCEB Concealed Floor Power Infeed Cover - \$35

Telecom Plates

- Each power unit has 1 plate. All telecom connectors sold separately.

[Click Here for Graded in Pricing](#)

2 Select Finish

3 Select Feet Finish

4 Select Edge

Click to view details

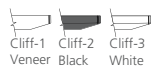

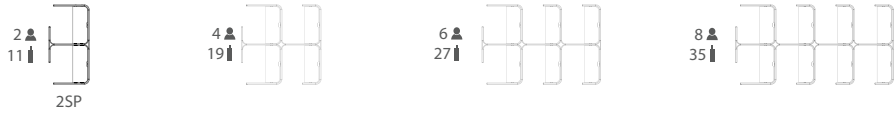

Number of Feet per Typical (MTL10 Option)

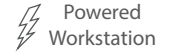

1 Select Model

Weight

Standard Veneer Top
Upholstered Panels - COM\$

Premium Veneer Top
Upholstered Panels - COM\$

High Pressure Laminate Top
Upholstered Panels - COM\$

Thermally Fused Laminate Top
Upholstered Panels - COM\$

w" x d" x h"	Weight
282 x 143 x 55	8 HNY282143FP562W 54207
212 x 143 x 55	6 HNY212143FP562W 41572
143 x 143 x 55	4 HNY143143FP562W 28937
73 x 143 x 55	2 HNY73143FP562W 16302

"P" Option N/A
"P" Option N/A
"P" Option N/A
"P" Option N/A

HNY282143FP562G	52543
HNY212143FP562G	40324
HNY143143FP562G	28105
HNY73143FP562G	15886

HNY282143FP562M	49367
HNY212143FP562M	37942
HNY143143FP562M	26517
HNY73143FP562M	15092

[Click here to view statement of line](#)

Product Features

- HNY6625WT162 Fixed Desk Height Worksurfaces are included
- 5" Solid wood feet - oval shape
- 4 Power outlets with 1 telecom plate, see options below for telecom plate
- Ships KD
- Wire management tray attaches to worksurface top, standard in MFW White, see premium Metal Finish for options
- Hardwire infeed and jumpers are included in workstations
- T75 worksurface wire cutout is standard on all worksurfaces.(T75D: Delete cutout is optional)

Options

Accessories

- K28: Articulating Keyboard w/ Mouse - \$390
- K31-SK: Center drawer w/ skirt - \$310
- K31: Center drawer w/o skirt - \$205

Concealed Floor Power Infeed Cover

- PCEB: White Metal Finish concealed floor power infeed cover - \$150

Delete Top and Wire Tray

- DFP: Delete fixed top. Deduct \$1535 Veneer (W), \$1335 High Pressure Laminate (G), \$953 Thermally Fused Laminate (M) per top

Metal Feet

- MTL10: Replace solid wood feet with metal feet, standard MFW White - \$55 ea

Premium Metal Finish

- See Front of Price List for Premium Metal Finish Options
- Premium Metal Finish for WMT Wire Management Tray - \$75 ea
- Premium Metal Finish for MTL10 Metal Feet - \$20 ea
- Premium Metal Finish for PCEB Concealed Floor Power Infeed Cover - \$35

Telecom Plates

- Each power unit has 1 plate. All telecom connectors sold separately.
- RJ45 (1) - \$55, RJ45 (2) - \$110, RJ45 (3) - \$165, USB (1) - \$70, USB (2) - \$140, RJ45/USB - \$125, RJ45/HDMI - \$210, HDMI/USB - \$205
- THL-42: Modify worksurface height to bar height - N/C

[Click Here for Graded in Pricing](#)

2 Select Finish

[Click to view finishes](#)

[Click to view finishes](#)

[Click to view finishes](#)

3 Select Feet Finish

4 Select Edge

[Click to view details](#)

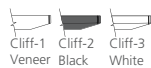

Honey

90° Starter Panel
Flat End

[Click here to view statement of line](#)

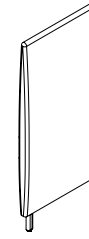

1 Model
HNY2455SP908

w" x d" x h"
24 x 3 x 55

COM	COL	1	2	3	4	5	6	7	8	9	10	11/L1	12	13/L2
1000	N/A	1065	1097	1129	1161	1193	1225	1257	1289	1321	1353	1385	1417	1481

Upholstery Requirements
Fabric yds: 1.75 Leather Sq. Ft.:N/A
Carton Weight:15

Product Features

- 5" Solid wood feet - oval shape

Notes

- To configure workstations, customer is required to send drawing

Options

Metal Feet

- MTL10: Replace solid wood feet with metal feet, standard in MFW White - \$55 ea

Premium Metal Finish

- See Front of Price List for Premium Metal Finish Options
- Premium Metal Finish for MTL10: Metal feet \$20 per foot

2 Select Finish

[Click to view finishes](#)

3 Combination Fabrics

[Click to view finishes](#)

Combination
Fabric Option
Not Available

Honey

90° Starter Panel
Flat End

[Click here to view statement of line](#)

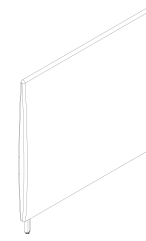

1 Model
HNY5555SP909

w" x d" x h"
54 x 3 x 55

COM	COL	1	2	3	4	5	6	7	8	9	10	11/L1	12	13/L2
1451	N/A	1581	1645	1709	1773	1837	1901	1965	2029	2093	2157	2221	2285	2413

Upholstery Requirements
Fabric yds: 3.5 Leather Sq. Ft.:N/A
Carton Weight:35

Product Features

- 5" Solid wood feet - oval shape

Notes

- To configure workstations, customer is required to send drawing

Options

Metal Feet

- MTL10: Replace solid wood feet with metal feet, standard in MFW White - \$55 ea

Premium Metal Finish

- See Front of Price List for Premium Metal Finish Options
- Premium Metal Finish for MTL10: Metal feet \$20 per foot

2 Select Finish

[Click to view finishes](#)

3 Combination Fabrics

[Click to view finishes](#)

Combination
Fabric Option
Not Available

Honey

90° Corner Panel Connector
Two Way Corner Connector

[Click here to view statement of line](#)



1 Model HNY1055CP905

w" x d" x h"
9.5 x 9.5 x 55

COM	COL	1	2	3	4	5	6	7	8	9	10	11/L1	12	13/L2
619	N/A	656	674	692	710	728	746	764	782	800	818	836	854	890

Upholstery Requirements
Fabric yds: 1 Leather Sq. Ft.:N/A
Carton Weight:10

Product Features

- 5" Solid wood feet - oval shape

Notes

- To configure workstations, customer is required to send drawing

Options

Metal Feet

- MTL10: Replace solid wood feet with metal feet, standard in MFW White - \$55 ea

Premium Metal Finish

- See Front of Price List for Premium Metal Finish Options
- Premium Metal Finish for MTL10: Metal feet \$20 per foot

2 Select Finish

[Click to view finishes](#)

3 Combination Fabrics

[Click to view finishes](#)

Combination
Fabric Option
Not Available

Honey

90° Corner Panel Connector
 Three Way Corner Connector

[Click here to view statement of line](#)



1 Model
HNY1655CP906

w" x d" x h"
 16 x 9.5 x 55

COM	COL	1	2	3	4	5	6	7	8	9	10	11/L1	12	13/L2
855	N/A	929	965	1001	1037	1073	1109	1145	1181	1217	1253	1289	1325	1397

Upholstery Requirements
 Fabric yds: 2 Leather Sq. Ft.:N/A
 Carton Weight:15

Product Features

- 5" Solid wood feet - oval shape

Notes

- To configure workstations, customer is required to send drawing

Options

Metal Feet

- MTL10: Replace solid wood feet with metal feet, standard in MFW White - \$55 ea

Premium Metal Finish

- See Front of Price List for Premium Metal Finish Options
 - Premium Metal Finish for MTL10: Metal feet \$20 per foot

2 Select Finish

[Click to view finishes](#)

3 Combination Fabrics

[Click to view finishes](#)

Combination
 Fabric Option
 Not Available

Honey

90° Corner Panel Connector
 Four Way Corner Connector

[Click here to view statement of line](#)



1 Model
HNY1655CP907

w" x d" x h"
 16 x 16 x 55

COM	COL	1	2	3	4	5	6	7	8	9	10	11/L1	12	13/L2
1134	N/A	1218	1259	1300	1341	1382	1423	1464	1505	1546	1587	1628	1669	1751

Upholstery Requirements
 Fabric yds: 2.25 Leather Sq. Ft.:N/A
 Carton Weight:20

Product Features

- 5" Solid wood feet - oval shape

Notes

- To configure workstations, customer is required to send drawing

Options

Metal Feet

- MTL10: Replace solid wood feet with metal feet, standard in MFW White - \$55 ea

Premium Metal Finish

- See Front of Price List for Premium Metal Finish Options
 - Premium Metal Finish for MTL10: Metal feet \$20 per foot

2 Select Finish

[Click to view finishes](#)

3 Combination Fabrics

[Click to view finishes](#)

Combination
 Fabric Option
 Not Available

Honey

90° Adder Panel
No Power Access

[Click here to view statement of line](#)

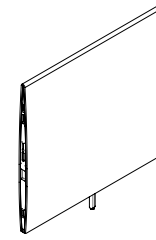

1 Model HNY5455AP904

w" x d" x h"
53.5 x 3 x 55

COM	COL	1	2	3	4	5	6	7	8	9	10	11/L1	12	13/L2
1406	N/A	1536	1600	1664	1728	1792	1856	1920	1984	2048	2112	2176	2240	2368

Upholstery Requirements
Fabric yds: 3.5 Leather Sq. Ft.:N/A
Carton Weight:35

Product Features

- 5" Solid wood feet - oval shape

Notes

- To configure workstations, customer is required to send drawing
- Panel overall height is 55" with feet. Panel overall height without feet is 50"

Options

Metal Feet

- MTL10: Replace solid wood feet with metal feet, standard in MFW White - \$55 ea

Premium Metal Finish

- See Front of Price List for Premium Metal Finish Options
- Premium Metal Finish for MTL10: Metal feet \$20 per foot

2 Select Finish

[Click to view finishes](#)

3 Combination Fabrics

[Click to view finishes](#)

Combination
Fabric Option
Not Available

Honey

90° Adder Panel
Single Sided Access

[Click here to view statement of line](#)

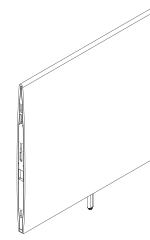

1 Model
HNY5455AP910

w" x d" x h"
53.5 x 3 x 55

COM	COL	1	2	3	4	5	6	7	8	9	10	11/L1	12	13/L2
1456	N/A	1586	1650	1714	1778	1842	1906	1970	2034	2098	2162	2226	2290	2418

Upholstery Requirements
Fabric yds: 3.5 Leather Sq. Ft.:N/A
Carton Weight:35

2 Select Finish

[Click to view finishes](#)

3 Combination Fabrics

[Click to view finishes](#)

Combination
Fabric Option
Not Available

Product Features

- 5" Solid wood feet - oval shape
- Panel features access panel for wire management

Notes

- To configure workstations, customer is required to send drawing
- Panel overall height is 55" with feet. Panel overall height without feet is 50"
- Removable panel allows wire access for cable management

Options

Metal Feet

- MTL10: Replace solid wood feet with metal feet, standard in MFW White - \$55 ea

Premium Metal Finish

- See Front of Price List for Premium Metal Finish Options
- Premium Metal Finish for MTL10: Metal feet \$20 per foot

Honey

90° Single Sided Power Panel
Power Panel

[Click here to view statement of line](#)

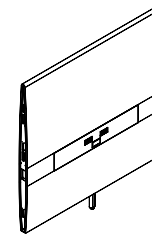

1 Model HNY5455PP911

w" x d" x h"
53.5 x 3 x 55

COM	COL	1	2	3	4	5	6	7	8	9	10	11/L1	12	13/L2
1725	N/A	1855	1919	1983	2047	2111	2175	2239	2303	2367	2431	2495	2559	2687

Upholstery Requirements
Fabric yds: 3.5 Leather Sq. Ft.:N/A
Carton Weight:35

2 Select Finish

[Click to view finishes](#)

3 Combination Fabrics

[Click to view finishes](#)

Combination
Fabric Option
Not Available

Product Features

- 5" Solid wood feet - oval shape
- 4 power outlets with 1 telecom plate, see options below for telecom plate

Notes

- To configure workstations, customer is required to send drawing
- Panel overall height is 55" with feet. Panel overall height without feet is 50"
- Jumper(s) or hardwired infeed must be selected to power workstations. See options below.

Options

Metal Feet

- MTL10: Replace solid wood feet with metal feet, standard in MFW White - \$55 ea

Jumper(s) and Infeed

- Specify Jumper or Infeed to power workstations
- JC70:70" Length Jumper-Passes through corner post connecting 2 panels-\$180
- JC140: 140" Length Jumper-passes through one 54" added panel connecting 3 panels-\$270
- JC210: 210" Length Jumper-passes through (2) 53" added panels connecting 4 panels-\$360
- JC280: 280" Length Jumper- passes through (3) 53" added panels connecting 5 panels-\$450
- JC115: 115" Length Jumper-passes through one 34" adder panel connecting (3) panels-\$240
- CPF72: 72" corded power feed -\$275
- HPP192: 192" hardwired power feed -\$350

Telecom Plates

- Each power unit has 1 plate. All telecom connectors sold separately.
- RJ45 (1) - \$55, RJ45 (2) - \$110, RJ45 (3) - \$165, USB (1) - \$70, USB (2) - \$140, RJ45/USB - \$125, RJ45/HDMI - \$210, HDMI/USB - \$205

Honey

90° Double Sided Power Panel
Power Panel

[Click here to view statement of line](#)

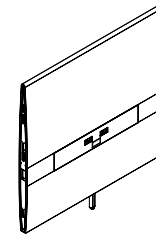

1 Model HNY5455PP912

w" x d" x h"
53.5 x 3 x 55

COM	COL	1	2	3	4	5	6	7	8	9	10	11/L1	12	13/L2
1527	N/A	1657	1721	1785	1849	1913	1977	2041	2105	2169	2233	2297	2361	2489

Upholstery Requirements
Fabric yds: 3.5 Leather Sq. Ft.:N/A
Carton Weight:35

2 Select Finish

[Click to view finishes](#)

3 Combination Fabrics

[Click to view finishes](#)

Combination
Fabric Option
Not Available

Product Features

- 5" Solid wood feet - oval shape
- Double sided power panel, each panel side features 4 power outlets with 1 telecom plate. See options below for telecom plate

Notes

- To configure workstations, customer is required to send drawing
- Panel overall height is 55" with feet. Panel overall height without feet is 50"
- Jumper(s) or hardwired infeed must be selected to power workstations. See options below.

Options

Metal Feet

- MTL10: Replace solid wood feet with metal feet, standard in MFW White - \$55 ea

Jumper(s) and Infeed

- Specify Jumper or Infeed to power workstations
- JC70:70" Length Jumper-Passes through corner post connecting 2 panels-\$180
- JC140: 140" Length Jumper-passes through one 54" added panel connecting 3 panels-\$270
- JC210: 210" Length Jumper-passes through (2) 53" added panels connecting 4 panels-\$360
- JC280: 280" Length Jumper- passes through (3) 53" added panels connecting 5 panels-\$450
- JC115: 115" Length Jumper-passes through one 34" adder panel connecting (3) panels-\$240
- CPF72: 72" corded power feed -\$275
- HPP192: 192" hardwired power feed -\$350

Telecom Plates

- Each power unit has 1 plate. All telecom connectors sold separately.
- RJ45 (1) - \$55, RJ45 (2) - \$110, RJ45 (3) - \$165, USB (1) - \$70, USB (2) - \$140, RJ45/USB - \$125, RJ45/HDMI - \$210, HDMI/USB - \$205

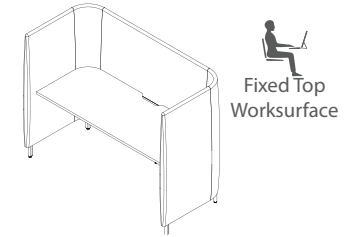

Panels
not included

[Click here to view statement of line](#)

1 Select Model

Weight

Standard Veneer Top

Premium Veneer Top

High Pressure Laminate Top

Thermally Fused Laminate Top

w" x d" x h"	Weight	Standard Veneer Top	Premium Veneer Top
Bar Height 42"			
67 x 26 x 1	55	HNY6726WT160W 1378	"P" Option N/A
47 x 26 x 1	50	HNY4726WT160W 1309	"P" Option N/A
Desk Height 29"			
67 x 26 x 1	55	HNY6726WT162W 1378	"P" Option N/A
47 x 26 x 1	50	HNY4726WT162W 1309	"P" Option N/A

"P" Option N/A
"P" Option N/A

HNY6726WT160G 1170
HNY4726WT160G 1125

HNY6726WT160M 773
HNY4726WT160M 738

2 Select Finish

[Click to view finishes](#)

[Click to view finishes](#)

[Click to view finishes](#)

3 Select Feet Finish

4 Select Edge

[Click to view details](#)

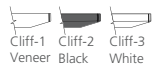

Product Features

- 1" Thick top
- Bar height 42", desk height 29"
- Ships KD
- T75 worksurface wire cutout is standard on all worksurfaces.(T75D: Delete cutout is optional)

Notes

- PANELS NOT INCLUDED

Options

Wire Tray / Premium Metal Finish

- WMT: Wire metal tray. Mounts under top and comes standard in MFW White - \$210

Premium Metal Finish

- See Front of Price List for Premium Metal Finish Options
- Premium Metal Finish for WMT wire management tray - \$75 ea

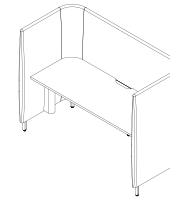

Panels
not included

[Click here to view statement of line](#)

Product Features

- Worksurfaces are 1" thick.
- Lift standard in MFW White, optional MFB Black
- Ships KD
- Wire management tray attaches to worksurface top, standard in MFW White, see premium Metal Finish for options

Notes

- 1" Gap between worksurface and panels to drop wires below worksurface
- Metal parts include 5 year warranty
- Programmable height adjustable mechanism, motor includes 2 year warranty
- Height adjustable top with mechanism and wire tray only, panels not included

Options

Premium Metal Finish

- See Front of Price List for Premium Metal Finish Options
- Premium Metal Finish for WMT wire management tray - \$75 ea

1 Select Model

Weight

Standard Veneer Top

Premium Veneer Top

High Pressure Laminate Top

Thermally Fused Laminate Top

w" x d" x h"	Weight	Standard Veneer Top	Premium Veneer Top
66 X 25 X 1	110	HNY6727WT163W 3999	"P" Option N/A
46 X 25 X 1	100	HNY4727WT163W 3931	"P" Option N/A

"P" Option N/A
 "P" Option N/A

HNY6727WT163G	3790
HNY4727WT163G	3745

HNY6727WT163M	3392
HNY4727WT163G	3358

2 Select Finish

[Click to view finishes](#)

[Click to view finishes](#)

[Click to view finishes](#)

3 Select Feet Finish

4 Select Edge

[Click to view details](#)

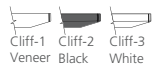

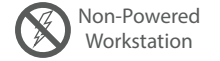
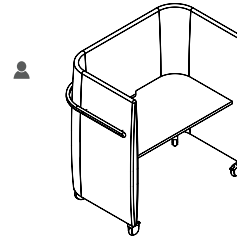

1 Select Model

w" x d" x h"	Weight
73 x 34 x 55	200
54 x 34 x 55	180

Standard Veneer Top Upholstered Panels - COM\$

HNY7334FT569W	6843
HNY5434FT569W	6386

Premium Veneer Top Upholstered Panels - COM\$

"P" Option N/A	
"P" Option N/A	

High Pressure Laminate Top Upholstered Panels - COM\$

HNY7334FT569G	6635
HNY5434FT569G	6202

Thermally Fused Laminate Top Upholstered Panels - COM\$

HNY7334FT659M	6238
HNY5434FT659M	5815

Product Features

- T75 worksurface wire cutout is standard on all worksurfaces.(T75D: Delete cutout is optional)
- Wood hand rails around outside mounted on wood standoffs
- HNY6726WT160 Fixed Desk Height worksurfaces, 29" worksurface height
- Ships KD

Options

Accessories

- K28: Articulating Keyboard w/ Mouse - \$390
- K31-SK: Center drawer w/ skirt - \$310
- K31: Center drawer w/o skirt - \$205

Casters

- 2 locking and 2 non-locking casters. Available in BK: Black (standard) or GR: Grey (optional)

Wire Tray

- WMT: Wire metal tray. Mounts under top and comes standard in MFW White - \$210

Premium Metal Finish

- See Front of Price List for Premium Metal Finish Options
- Premium Metal Finish for WMT Wire Management Tray - \$75 ea

Tully Inline Power

- PD-TULLY-IN-72: 2 power/dual USB up, 4 power down, 72" power cord - \$660
- PD-TULLY-IN-120: 2 power/dual USB up, 4 power down, 120" power cord - \$682

[Click Here for Graded in Pricing](#)

2 Select Finish

Top Finishes

Click to view finishes

Top Finishes

Click to view finishes

Top Finishes

Click to view finishes

3 Select Feet Finish

4 Select Edge

Click to view details

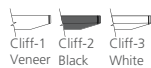

1 

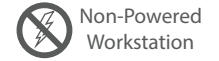
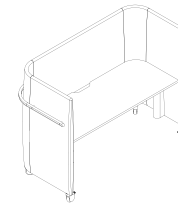

1 Select Model

Weight

Standard Veneer Top Upholstered Panels - COM\$

Premium Veneer Top Upholstered Panels - COM\$

High Pressure Laminate Top Upholstered Panels - COM\$

Thermally Fused Laminate Top Upholstered Panels - COM\$

w" x d" x h"	Weight	Model	Price
73 x 34 x 55	245	HNY7334HA569W	9464
54 x 34 x 55	225	HNY5434HA569W	9006

"P" Option N/A
"P" Option N/A

HNY7334HA569G	9255
HNY5434HA569G	8821

HNY7334HA569M	8858
HNY5434HA569M	8434

[Click here to view statement of line](#)

Product Features

- 1" Gap between worksurface and panels to drop wires below worksurface
- Programmable height adjustable mechanism, motor includes 2 year warranty
- Wood hand rails around outside mounted on wood standoffs
- 2 locking and 2 non-locking casters. Available in BK: Black (standard) or GR: Grey (optional)
- Adjustable height from 27" to 47.5" with a maximum weight capacity of 275 lbs. Lift standard in MFW White, optional MFB Black
- HNY6625WT163 Height Adjustable worksurfaces is included
- Wire management tray attaches to worksurface top, standard in MFW White, see premium Metal Finish for options
- T75 worksurface wire cutout is standard on all worksurfaces.(T75D: Delete cutout is optional)

[Click Here for Graded in Pricing](#)

2 Select Finish

Top Finishes

[Click to view finishes](#)

Top Finishes

[Click to view finishes](#)

Top Finishes

[Click to view finishes](#)

Options

Accessories

- K28: Articulating Keyboard w/ Mouse - \$390
- K31-SK: Center drawer w/ skirt - \$310
- K31: Center drawer w/o skirt - \$205

Casters

- 2 locking and 2 non-locking casters. Available in BK: Black (standard) or GR: Grey (optional)

Premium Metal Finish

- See Front of Price List for Premium Metal Finish Options
- Premium Metal Finish for WMT Wire Management Tray - \$75 ea
- Premium Metal Finish for PCEB Concealed Floor Power Infeed Cover - \$35

Tully Inline Power

- PD-TULLY-IN-72: 2 power/dual USB up, 4 power down, 72" power cord - \$660
- PD-TULLY-IN-120: 2 power/dual USB up, 4 power down, 120" power cord - \$682

3 Select Feet Finish

4 Select Edge

[Click to view details](#)



Honey

90° Worksurface Privacy Screen
 Worksurface PET Privacy Screen

[Click here to view statement of line](#)

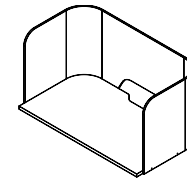

Top
not included

1 Select Model

w" x d" x h"

Weight

Worksurface Screen PET			
46 x 23 x 24	10	PS46	494
66 x 23 x 24	10	PS66	515

Product Features

- Screen attaches to worksurface top
- PET Screen 1/2" thick with rounded corners
- Composed of 100% polyester fiber
- 50% post-consumer recycled content
- Adds additional acoustical absorption

Notes

- Available on both 47" and 67" worksurfaces
- Only available on Height Adjustable Worksurfaces

2 Select Finish

[Click to view finishes](#)

Finish N/A

3 Select Edge

Edge N/A

Select acoustic color

[Click to view details](#)

- Light Gray 3
- Deep Blue 9
- Dark Gray 17
- Pure Gray 34
- Berry Red 36
- Ivory 44
- Emerald 47
- Smoky Beige 53
- Heathered Granite 71
- Heathered Oatmeal 75

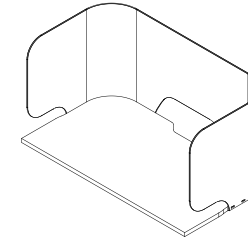

Top
not included

1 Select Model

w" x d" x h"
46 x 24 x 24

Weight

20

Worksurface Screen
Frosted Acrylic

AS46AF

1746

Worksurface Screen
Matte White Acrylic

AS46AW

1876

Worksurface Screen
Matte Black Acrylic

AS46AB

1876

2 Select Finish

AF

AW

AB

[Click here to view statement of line](#)

Product Features

- Acrylic screens with rounded corners
- 1/4" Thick screen
- Screen attaches to worksurface top

Notes

- Matte acrylic is not a writable surface
- Available on 46" wide 90° worksurfaces
- Only available on Height Adjustable Worksurfaces

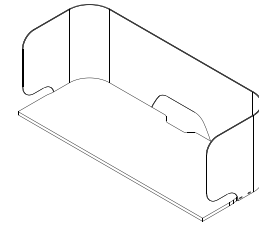

Top
not included

1 Select Model

w" x d" x h"
66 x 24 x 24

Weight
20

Worksurface Screen
Frosted Acrylic
AS66AF 1973

Worksurface Screen
Matte White Acrylic
AS66AW 2103

Worksurface Screen
Matte Black Acrylic
AS66AB 2103

2 Select Finish

AF

AW

AB

[Click here to view statement of line](#)

Product Features

- Acrylic screens with rounded corners
- 1/4" Thick screen
- Screen attaches to worksurface top

Notes

- Matte acrylic is not a writable surface
- Available on 66" wide 90° worksurfaces
- Only available on Height Adjustable Worksurfaces

DARRAN®

Zip Wire Manager

Style Number	List Price
WMS1 - Fabric	\$77
WMS3 - Neoprene	\$88

Specifications

- > Dimensions: 30" x 1.5" diameter
- > Attaches to wire basket
- > Zips up, bundles and routes loose, messy cables into a single tube
- > Routes and guides cables from Honey height adjustable worksurface to power panel
- > Accommodates large or small cables, up to 10 cords at once
- > WMS1: Fabric wire manager matches panel fabric. Not sold separately from panels.
- > WMS3 : Neoprene wire manager

Available: Honey



Fabric Sleeve
WMS1

Neoprene Sleeve
WMS3

Honey Options

Wire Management Sleeve



Neoprene Colors



White



Black



Gray

DARRAN®

Honey Options

Worksurface Reconfiguration Cover

Style Number List Price
HBC: 4 Worksurface Reconfiguration Covers \$109

Honey has the ability to adapt with your office as you modify seating positions. The panels can be reconfigured to allow additional workspaces or to modify workspaces to lounge areas. When workspaces are attached to a panel, mounting is required. The Worksurface Reconfiguration Covers allow those mounting positions to be concealed. These covers simply press fit into the Honey panels.

Available: Honey

Standard Colors

STANDARD

OPTIONAL



MFW White
Satin Finish
(Standard)

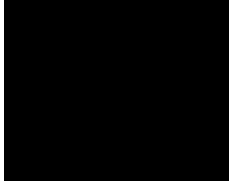

MFB Black
Satin Finish
(Optional - N/C)



Worksurface Reconfiguration
Covers

DARRAN®

Trek Desktop LED Task Light

Style Number	List Price
TSATL-CM Clamp Mount	\$584
TSATL-SM Surface Mount	\$556
TSATL-FBU Freestanding Base w/ USB	\$693
Trek - Includes 9.5" Extended Arm	
TDATL-CM Clamp Mount	\$649
TDATL-SM Surface Mount	\$622
TDATL-FBU Freestanding Base w/ USB	\$758
HTLOCS - Occupancy sensor, option	\$93

*Surface Mount application requires field installation, 2-1/8" grommet hole bored on site.

Specifications

- > Made with fully-recyclable aluminum and plastic.
- > ENERGY CONSUMPTION: 7.2 system watts; 13.5 system watts with USB
- > NUMBER OF LEDS: 18 fractional LEDs
- > LIGHT OUTPUT: 294 lumens
- > EFFICACY: 41 Lm/W
- > LED RATED LIFESPAN: > 50,000 hours
- > COLOR TEMPERATURE: 3500K
- > COLOR RENDERING INDEX: 85
- > BRIGHTNESS ADJUSTABILITY: 100%–15% continuous
- > AUTO SHUT OFF: after 10 hours
- > USB CHARGE PORT: dedicated Type-A connector 5V, 1.2A max
- > POWER SUPPLY: 18-watt wall transformer with 9' black cord
- > CORD: 3' silver cord with quick connector
- > ETL listed: compliant to UL 153/8750 & CSA C22.2, No. 250.4; FCC Part 15 Class B; TAA; BAA; CEC Title 20
- > WARRANTY: 10 years fixture, 5 years power supply

Available: All DARRAN collections



Trek
Includes 9.5" Extended Arm

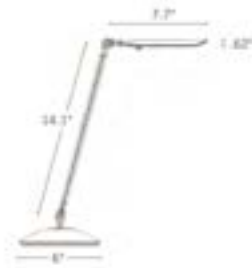

Trek
No Extended Arm



Honey Options



Surface
Mount



Clamp
Mount



Freestanding with
USB Mount

Select Finish Color



DARRAN®

Coat Hook

Style Number	List Price
HSCH (Single Sided)	\$104
HDCH (Double Sided)	\$153

Specifications

- > Decorative finished coat hook, select veneer finish for knob.
- > Available in White or Black Standard Metal Finish. Premium finishes are available.
- > Coat hook slides into position on the tops of the Honey panel system and can be easily repositioned.
- > Available in single or double sided coat hook.
- > Each knob can hold weight up to 50lbs.

Note:
Signage Company can add vinyl lettering to feature a persons name, logo etc.

Available: Honey

Standard Colors - Available in single or double sided coat hook

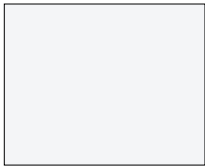

MFW White
Satin Finish
(Standard)



MFB Black
Satin Finish
(Optional - N/C)

Premium Colors - +\$50

Honey Options



Single Sided Coat Hook



Double Sided Coat Hook

Rotating Bag Hook

Style Number
HPH

List Price
\$55

Specifications

- › 360° swivel rotation
- › Under surface mounted
- › Holds up to 25lbs
- › Notched grooves in the base provide four stop points at 90 degree intervals where hook clicks into place while rotating.

Available: All DARRAN collections

Standard Finishes

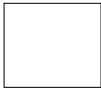

White



Black



DARRAN®

Hanging Leather Storage Pocket

Style Number	List Price
HSSB (Single Sided)	\$349
HDSB (Double Sided)	\$578

Specifications

- > Store and organize paperwork for easy access.
- > Pricing includes Green Hides Lena Leather. Must specify color or specify customers own leather (HSSB requires 3.5 sqft. HDSB requires 7 sqft.)
- > Metal hooks available in White or Black Standard Metal Finish. Premium finishes are available.
- > Hanging Leather Storage Pockets offered in single and double sided.
- > Hanging Leather Storage Pocket slides into position on the tops of the Honey panel system and can be easily repositioned.
- > Can hold up to 20lbs.

Note:

Signage Company can add vinyl lettering to feature a persons name, logo etc.

Available: Honey

Standard Colors (Metal)

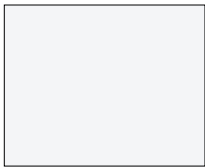

MFW White
Satin Finish
(Standard)

MFB Black
Satin Finish
(Optional - N/C)

[Click here to view Green Hides Lena Leather](#)

Premium Colors - +\$50

Honey Options

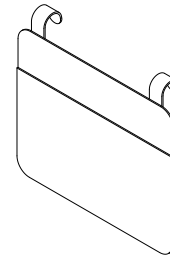

Single Sided

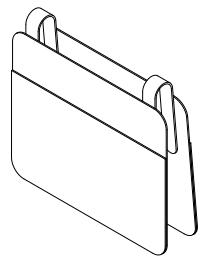

Double Sided

Style Number	List Price
HDMB	\$273

Specifications

- > Dry erase marker board, available in White Metal Finish
- > Single side use, marker boards can nest together for double sided application.
- > Marker board slides into position on the tops of the Honey panel system and can be easily repositioned.

Available: Honey



DARRAN®

Hanging Planter

Style Number	List Price
HHP1(Rounded Ceramic)	\$159
HHP2(Cylindrical Stone Powder)	\$276

Specifications

- > Mounted to metal panel hook.
- > No drainage holes.
- > Metal hooks available in White or Black Standard Metal Finish. Premium finishes are available.
- > Hanging planter comes in a rounded ceramic or cylindrical stone powder.

Available: Honey

Standard Colors (Metal)



MFW White
Satin Finish
(Standard)

MFB Black
Satin Finish
(Optional - N/C)

Premium Colors(Matte) - +\$50

Honey Options



DARRAN®

Round Wastebasket with Lid

Style Number List Price
HTC \$415

Specifications

- › Size: 7.5" diameter x 10.7" high
- › Easy-push swing lid allows you to store in plain sight; The trash is contained and out of view.
- › Attaches to inside corner of Honey workstation configurations.
- › Trash can sits on 3/4" thick wood round disc.
- › Easy to clean. Wipe clean with a damp cloth; The durable interior can be rinsed out with mild soap and water when needed.
- › Made of durable BPA and Chlorine free shatter-resistant plastic.
- › Standard with removable lid.

Available: Honey

Honey Options



Step 1: Select Wastebasket Color



White/Gray



Charcoal



Black

Step 2: Select wood finish for base

Aircharge wireless charging grommet

Style Number	List Price
 ACWG WIRELESS GROMMET	\$213

Specifications

- > When used with GROVE Tables an additional \$350 LIST will apply for the special cutout required.
- > AirCharge offers a convenient way to charge any Qi compatible smartphone or device without the need to carry charging cables or find an available power outlet.
- > The Aircharge is powered by the latest Qi compliant IC offering reliable and efficient wireless charging in a convenient 3" grommet hub. Simply place your phone on the Aircharge and an LED will confirm pairing and begin wireless charging.
- > Recess: Efficient space conservation and quick access
- > Input: DC 5V (with included AC power adapter), DC 9V, 1.67A (with optional QC 2.0 power adapter)
- > Output: 5 watts Max. with DC 5V, 2A power adapter, 10 watts Max. with QC 2.0 power adapter
- > Qi V1.2 compliant IC
- > Charging distance: 6mm Max.

Available: All DARRAN collections



Cove power unit - non-linking

Style Number	List Price
 PD-COVE PLUG	\$600
Non-linking version	

Specifications

- > Size 5.75"L x 2.5"W
- > (2) 15 Amp Receptacles and (2) USB charging ports
- > Surface Mount
- > 108" Cord
- > Standard Silver Finish, Available in White or Black Finish upon request
- > ETL Listed

Available: All DARRAN collections



Soba wire manager

Style Number	List Price
STARTER UNITS	
SCDW	\$218
White wire manager	
SCDB	\$218
Black wire manager	



Specifications

- › Dimensions: 9ft x 9in x 3.15in
- › Zips up, bundles and routes loose, messy cables into a single tube
- › Routes and guides cables behind desks, TVs, and anywhere cables tend to get messy
- › Accommodates large or small cables, up to three cables at once
- › Support channels, used to route cables, include powerful adhesive backing which allows easy attachment to surfaces.

Available: All DARRAN collections



VILLA Power unit with daisylink

Style Number	List Price
STARTER UNITS	
 VIL-DCH HARDWIRED	\$975
Includes (1) Villa unit with 120" Hardwire Infeed	
 VIL-DCP PLUG	\$975
Includes (1) Villa with Plug Infeed - Includes 72" Cord and 32" Infeed Jumper for 104" total cord infeed	
ADDITIONAL LINKING UNITS	
VIL-DCL ADDITIONAL	\$950
(Includes linking Villa and Jumper cable up to 96")	

Specifications

- > Size: Top Grommet 5.68"L X 3.39"W; Under Top 12"L x 3.13"W x 3.08"D
- > (4) Power receptacles; (2) surface and (2) undersurface, (2) 2.1A USB charging ports and (1) Knockout for RJ45 Data Port
- > Surface Mount
- > Daisy Chain - Hardwire Max (10) Units, Plug/Corded Max (5) Units
- > Standard Silver Finish, Black Finish available upon request
- > UL or ETL Certified

Available: All DARRAN collections, excludes grove

RJ45 Knockout	
RJ45 (1)	\$55



Tully power unit

Style Number

List Price



PD-TULLY

\$349

Specifications

- > 5.5" W x 3.2" H x 1.8" D
- > Finish: Smooth molded plastic integrated within a single piece cover
- > Mounts to the edge of your work surface, with no table cut outs or installation required.
- > (2) Power receptacles, (2) USB 2.1 Amp ports
- > 72" Cord (10' cord available, contact customer service).
- > Standard in White. Available in gray, black, neon red, harvest pumpkin, light green, daisy blue.
- > UL310, Class 2, FCC Part 15A approved
- > Clamp accessory accommodates table thickness from .75"-1.5"

Available: Honey, EdgeWorks, NSS Open,, Thinking Quietly.

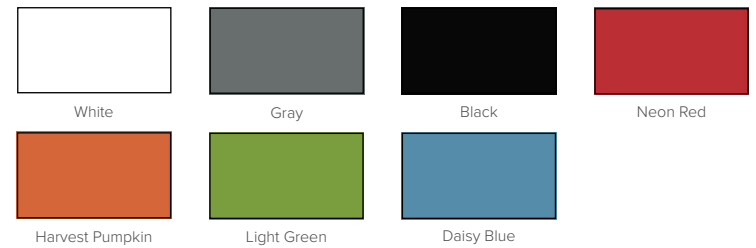

Tully Inline Power unit

Style Number

List Price



PD-Tully-IN72 72" Cord
 PD-Tully-IN120 120" Cord

\$660
 \$682

Specifications

PD TULLY Worksurface Unit

- > 5.5" W x 3.2" H x 1.81" D
- > Finish: Smooth molded plastic integrated within a single piece cover
- > Mounts to the edge of your work surface, with no table cut outs or installation required.
- > (2) Power receptacles, (2) USB 2.1 Amp ports
- > 72" and 120" Plug Cord
- > Standard in White. Available in gray, black, neon red, harvest pumpkin, light green, daisy blue.
- > UL310, Class 2, FCC Part 15A approved
- > Clamp accessory accomodates table thickness from .75"-1.5"

Tully Under Worksurface Unit

- > 11.75" x 2.5" x 2.05"
- > 4 - 15A, AC Power Outlets mounted under the worksurface
- > 24" Cord that connects to PD Tully
- > Comes with wire manager hooks to secure power cord when not in use
- > UL 962A Listed, UL 1310 Recognized, Meets UL Spill Requirements, Class 2, FCC Part 15 A Approved

Available: All Collections



Power Unit Color

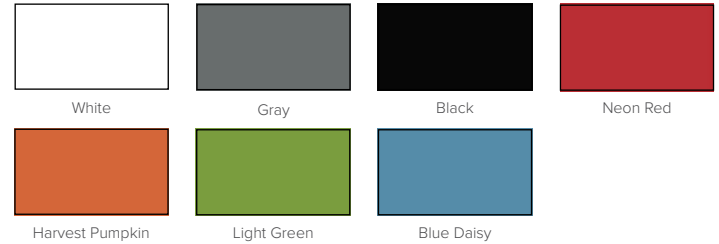

Cord Color

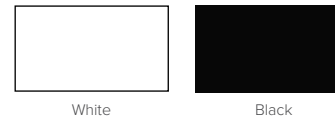

Keno power unit

Style Number

List Price



PD-KENO

\$213

Specifications

- > Size 5.5"L x 2.125"W x 2.5"H
- > 2 TR AC Outlets
- > 1 4.2A USB module w/ 2 charging ports
- > 10' Power cord

Available: Honey, EdgeWorks, NSS Open, Thinking Quietly



White



Black

Nuuk single power unit with undersurface mount

Style Number

List Price



PD-NUUK1-UM

\$317

Specifications

- > 1 AC receptacle with (1.5A) and fast-charging (2.4A) USB ports for rapid re-charging
- > 6' Power cord, available in black or white
- > Optional fabric woven cord in Graphite or Ivory - \$50
- > UL962A listed
- > UL1310 listed power supply
- > Size: 4.44"L x 4.11"x 2.33H
- > Undersurface mount



Available: On all DARRAN collections

Step 1: Select Body Color

White	Black	Cayenne	Clementine	Cranberry
Currant	Dijon	Eggplant	Forest	Goldenrod
Grape	Gulf	Kiwi	Maize	Marine
Merlot	Ocean	Paprika	Pineapple	Porcelain
Pumpkin	Punch	Raisin	Silver-Sage	Silver
Sky	Spruce	Teal	Tranquil	

Step 2: Select AC Receptacle Color

White	Linen	Black

Step 3: Select Cord Color

Ivory +\$50	Graphite +\$50	Black	White

Nuuk dual power unit with undersurface mount

Style Number

List Price



PD-NUUK2-UM

\$366

Specifications

- > 2 AC receptacle with (1.5A) and fast-charging (2.4A) USB ports for rapid re-charging
- > 6' Power cord, available in black or white
- > Optional fabric woven cord in Graphite or Ivory - \$50
- > UL962A listed
- > UL1310 listed power supply
- > Size: 6.11"L x 4.11"W x 2.33"H
- > Undersurface mount



Available: All DARRAN collections





Step 1: Select Body Color

 White	 Black	 Cayenne	 Clementine	 Cranberry
 Currant	 Dijon	 Eggplant	 Forest	 Goldenrod
 Grape	 Gulf	 Kiwi	 Maize	 Marine
 Merlot	 Ocean	 Paprika	 Pineapple	 Porcelain
 Pumpkin	 Punch	 Raisin	 Silver-Sage	 Silver
 Sky	 Spruce	 Teal	 Tranquil	

Step 2: Select AC Receptacle Color

 White	 Linen	 Black
--	--	--

Step 3: Select Cord Color

 Ivory +\$50	 Graphite +\$50	 Black	 White
--	---	--	--

Nuuk single power unit with clamp

Style Number

List Price



PD-NUUK1-CL

\$355

Specifications

- > 1 AC receptacle with (1.5A) and fast-charging (2.4A) USB ports for rapid re-charging
- > 6' Power cord, available in black or white
- > Optional fabric woven cord in Graphite or Ivory - \$50
- > UL962A listed
- > UL1310 listed power supply
- > Size: 4.44"L x 4.35"W x 3.03"H
- > Clamp mount: clamps onto surfaces of 3/4-1-1/4" thickness



Available: On all DARRAN collections, excluding Grove

Step 1: Select Body Color

White	Black	Cayenne	Clementine	Cranberry
Currant	Dijon	Eggplant	Forest	Goldenrod
Grape	Gulf	Kiwi	Maize	Marine
Merlot	Ocean	Paprika	Pineapple	Porcelain
Pumpkin	Punch	Raisin	Silver-Sage	Silver
Sky	Spruce	Teal	Tranquil	

Step 2: Select AC Receptacle Color

White	Linen	Black

Step 3: Select Cord Color

Ivory +\$50	Graphite +\$50	Black	White

Nuuk dual power unit with clamp

Style Number

List Price



PD-NUUK2-CL

\$409

Specifications

- > 2 AC receptacle with (1.5A) and fast-charging (2.4A) USB ports for rapid re-charging
- > 6' Power cord, available in black or white
- > Optional fabric woven cord in Graphite or Ivory - \$50
- > UL962A listed
- > UL1310 listed power supply
- > Size: 6.11"L x 4.35"W x 2.33"H
- > Clamp mount: clamps onto surfaces of 3/4-1-1/4" thickness

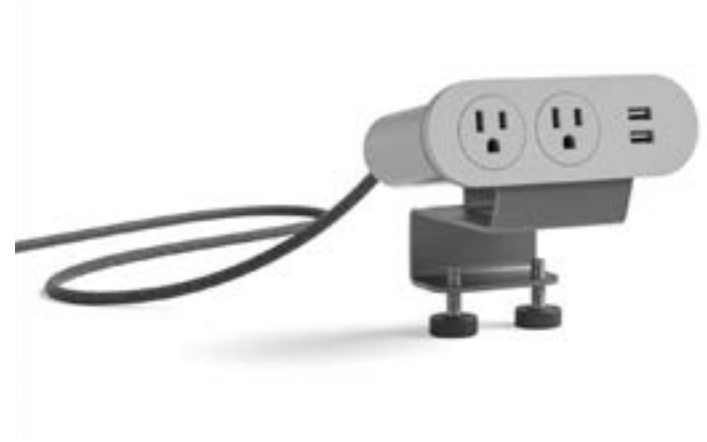

Available: All DARRAN collections, excluding Grove

Step 1: Select Body Color

White	Black	Cayenne	Clementine	Cranberry
Currant	Dijon	Eggplant	Forest	Goldenrod
Grape	Gulf	Kiwi	Maize	Marine
Merlot	Ocean	Paprika	Pineapple	Porcelain
Pumpkin	Punch	Raisin	Silver-Sage	Silver
Sky	Spruce	Teal	Tranquil	

Step 2: Select AC Receptacle Color

White	Linen	Black

Step 3: Select Cord Color

Ivory +\$50	Graphite +\$50	Black	White